



SAKURA

Filtration Product

Hydraulic

SUB-CATALOGUE



Worldwide Engine Partner

SUB-HYD-IV-2017



Table of Contents

Manufacturer's Cross Reference	A
Technical Specification	B
Engine Application	C



Manufacturer's Cross Reference

A



Manufacturer's Cross Reference

NO	REFERENCE NO	SAKURA NO	NO	REFERENCE NO	SAKURA NO	NO	REFERENCE NO	SAKURA NO	NO	REFERENCE NO	SAKURA NO
ABAC COMPRESSED AIR			ALCO			AMERICAN HOIST & DERRICK			ATLAS WEYHAUSEN		
1	8973035301	H-85521	1	SP-1303	HC-7920	1	1050495	HC-57020	1	0415567	H-62040
AC-DELCO			ALLIANCE			AMERICAN PARTS					
1	L20	H-65030	1	ABP/N10G-29540494	H-8537	1	91608	HC-42090	2	1003685	HC-62020
2	L7221	H-65030	ALLIED PRODUCTS CORPORATION			2	92447	HC-57020	3	1713844	H-51050
3	PF-2020	HC-7909	1	247429	HC-55250	3	92451	HC-57020	4	2604140	H-62040
4	PF-38	HC-6217	ALLIS CHALMERS			4	92455	HC-5507	5	3216921404	HC-6217
5	PF-495	H-79411	1	1329308	HC-62010	5	92543	H-57030	6	43193	H-8515
6	PF1088	HC-62010	2	185691	H-65030	6	92544	H-57030	ATP		
7	PF1098	HC-62010	3	18569155	H-65030	7	92731	HC-5506	1	B188	H-65030
8	PF156	H-65030	4	188056	H-65030	8	92758	HC-62010	AUSTOFT		
9	PF156X	H-65030	5	197121	H-65030	AP PARTS			AVELING-BARFORD		
10	PF2010	HC-5511	6	1971213	H-65030	1	3846	H-5001	1	ABP3001585	H-42020
11	PF2021	HC-5511	7	197878-2	H-7976	AP-LOCKHEED			2	ABP3003018	HC-45050
12	PF2023	HC-62010	8	221041	H-65030	1	AP-3074	H-79411	3	SWT603045	H-65030
13	PF2176	HC-57020	9	2210482	H-65030	2	AP3414	HC-62010	AVN HYDRAULICS		
14	PF26	HC-19040	10	31021	H-65030	3	AP3414A	HC-62010	1	136380	H-62060
15	PF828	HC-5511	11	31048945	H-65030	4	APH-3074A	H-79411	BADGER		
16	PF889	H-65030	12	31048946	H-65030	5	LK3414	HC-62010	1	76102474	H-57030
17	PF941	HC-5511	13	3104895	H-65030	ARAMINE			2	LG77561	HC-57020
18	PF941	HC-62010	14	3104896	H-65030	1	7707375	HC-55250	BALDWIN		
19	PF951	H-65030	15	431021	H-65030	ARDCO			1	B378	HC-6901
20	PM24A	H-65030	16	43353488	H-65030	1	ENE0181	HC-57020	2	B7026-MPG	HC-5101
ACAP FILTER			17	4347021	H-65030	ARGO			3	B7163	HC-7924
1	HC 53020	HC-51070	18	4369980	H-65030	1	P12211712	H-6301	4	B7163	HC-7946
2	HE 39070	H-51220	19	4369988	H-65030	2	P2-0933-01	H-7991	5	B7335-MPG	HC-76140
3	HE 76020	H-85570	20	43699880	H-65030	3	P2.0923.01	H-4904	6	B99-B	HC-5502
AG CHEM EQUIPMENT			21	43710219	H-65030	4	P2121712	H-6301	7	B99-SS	HC-5502
1	609666	HC-55260	22	4371133	H-65030	5	S9081702	H-62110	8	BF8813-MPG	HC-7604
2	609934	HC-5504	23	43711373	H-65030	6	V2.1217-08	H-6701	9	BT-345KIT	HC-7909
3	701734	H-79411	24	4596891	H-65030	ARLON			10	BT260-10	HC-7901
4	708476	HC-5511	25	4853338	H-57030	1	TXW8BCC25	H-71130	11	BT287	HC-62010
5	708476	HC-62010	26	597926	H-65030	2	TXX3-10-B	H-8515	12	BT287-10	HC-5511
6	709666	HC-62010	27	618179	H-65030	ASAS			13	BT305	HC-5801
7	714122	HC-5516	28	6628597	H-65030	1	AS182	H-76050	14	BT334	HC-7940
8	725896	H-5001	29	665859	H-65030	2	AS296H	H-6301	15	BT346	HC-7919
9	AG609666	HC-55260	30	6658597	H-65030	ASTEC UNDERGROUND			16	BT351	HC-7906
10	AG709666	HC-62010	31	79325	H-65030	1	70PF951	H-65030	17	BT354	HC-1902
AGCO			32	79352	H-65030	ASTRA			18	BT359	HC-6501
1	105256AS	H-65030	33	81733	H-65030	1	115754	H-85521	19	BT359	HC-6502
2	3383386M92	HC-51070	34	9038953	H-65010	2	60940011	H-42020	20	BT371-10	HC-69030
3	3386701M3	HC-51060	35	90828	H-65030	ATLAS			21	BT371-MPG	HC-7925
4	3608996M91	HC-7940	ALLISON			1	3607792	H-51050	22	BT372-10	HC-7929
5	4232923M1	HC-57020	1	18772	H-65030	2	4653916	H-51050	23	BT372-10	HC-7939
6	609666	HC-55260	2	23040988	H-53010	ATLAS COPCO			24	BT387	HC-62010
7	72257931	HC-51040	3	23042062	HC-69031	1	1202-8040-00	HC-7924	25	BT387-10	HC-5511
8	72257936	HC-51040	4	25010836	H-65030	2	1202-8040-00	HC-7946	26	BT388	HC-19060
9	72270891	HC-51040	5	25011194	H-65030	3	1202-8040-00DE1	HC-7946	27	BT388-10	HC-7938
10	72270894	HC-51040	6	29501202	H-7996	4	1202804002	HC-7946	28	BT389-10	HC-7933
11	74853388	H-57030	7	29501202	H-8538	5	1612-3980-00	HC-6217	29	BT389-10	HC-79331
12	928766	HC-55290	8	29501202	H-8538-S	6	16123980	HC-6217	30	BT398	HC-5601
13	FA57CC10	HC-55260	9	29501202C	H-7996	7	16136105	HC-6217	31	BT420	TC-7918
14	PM200641	HC-7972	10	29506337	H-8537	8	1613610500	HC-6217	32	BT424	HC-5511
AHLMANN			11	29509723	H-7997	9	1613610502	HC-6217	33	BT470	HC-45110
1	1215-027	H-6301	12	29509723A	H-7997	10	1616-4378	HC-6217	34	BT526-10	HC-7935
2	4197591A	H-7991	13	29509723B	H-7997	11	16164318	HC-6217	35	BT610-MPG	HC-7973
AIR HYDRAULIC SYSTEMS			14	29509723C	H-7997	12	1619-3771	HC-6217	36	BT735	HC-6802
1	AFS5706	HC-55290	15	29509723C	H-8537	13	1619-3980	HC-6217	37	BT739	HC-2701
2	AFS5712	HC-55260	16	29540494	H-8537	14	243622	HC-55250	38	BT747	HC-57020
AIR MAZE			17	29545779	H-8537	15	2901000000	HC-6217	39	BT775	HC-5402
1	CCEM1002	HC-42090	18	29545779	H-8537-S	16	3176722800	H-5001	40	BT8307MPG	HC-55260
AIR REFINER			19	29548988	H-8537-S	17	3176728000	H-5001	41	BT8308MPG	HC-79372
1	ARH0475LB03	HC-62010	20	5576200	H-65030	18	3216921404	HC-6217	42	BT8309-MPG	HC-7602
2	ARH160066	H-57030	21	SP6298	H-65030	19	359455	H-71140	43	BT8311	HC-55250
3	ARH160216	H-57030	AMBAC			20	372192	HC-57020	44	BT8315	HC-6801
4	ARH160468	H-57030	1	S59	HC-62010	21	375711	HC-55250	45	BT8316MPG	HC-69031
5	ARH160516	H-57030	AMC			22	415567	H-62040	46	BT8333	HC-5505
6	ARH160616	H-57030	1	KO1515	H-7976	23	511214106	H-65030	47	BT8368	HC-42090
7	ARH161571	H-57030	AMERICAN CRANE CORPORATION			24	515567	H-62040	48	BT8382	HC-1905
ALCO			1	1174455	HC-57020	25	8231101804	H-6701	49	BT8384	HC-6803



Manufacturer's Cross Reference

NO	REFERENCE NO	SAKURA NO	NO	REFERENCE NO	SAKURA NO	NO	REFERENCE NO	SAKURA NO	NO	REFERENCE NO	SAKURA NO
BALDWIN			BALDWIN			BALDWIN			BENFRA		
50	BT839	HC-1903	119	H9076	H-7975	188	PT8947-MPG	H-6701	1	0440126	H-62040
51	BT841	HC-8001	120	H9077	H-7917	189	PT8960-MPG	H-55331	BERGERAT MONNOYEUR		
52	BT8412	H-5901	121	H9080	H-55380	190	PT8962-MPG	H-62070	1	E5111	H-5001
53	BT8415	HC-76110	122	HF7834	H-55330	191	PT8971-MPG	H-76040	2	E5160	H-85110
54	BT8416	HC-76100	123	P-204HD	H-5405	192	PT8974-MPG	H-57040	BESTON		
55	BT8418	HC-55200	124	P7264	H-2717	193	PT90-10	H-5503	1	BH4TUF1209CH	H-85840
56	BT8426-MPG	HC-51020	125	PT 289	H-7936	194	PT90-10	H-5526	2	BV1-96546B	H-85850
57	BT8439-MPG	HC-45050	126	PT 8419	H-5632	195	PT9000MPG	H-62040	BIG A		
58	BT8439-MPG	HC-7965	127	PT-376	H-5403	196	PT903	H-71160	1	2107	H-7976
59	BT8440-MPG	HC-85030	128	PT-441	H-5608	197	PT9167	H-85521	2	2178	HC-19060
60	BT8463MPG	HC-57030	129	PT-83	H-5506	198	PT9169	H-5202	3	7407	H-53010
61	BT8466MPG	HC-57030	130	PT-91	H-5510	199	PT9172	H-2705	4	834	HC-62010
62	BT8488	HC-5816	131	PT189	H-5504	200	PT9186	H-8515	5	843	H-79411
63	BT8497-MPG	HC-76090	132	PT189-MPG	H-55270	201	PT9191	H-76050	6	91220	HC-45050
64	BT8512	HC-62020	133	PT189MPG	H-55320	202	PT9199	H-7991	7	91608	HC-42090
65	BT8801-MPG	HC-7603	134	PT191	H-7983	203	PT9238	H-7956	8	91740	H-8537
66	BT8802-MPG	HC-7601	135	PT207-HD	H-7941	204	PT9248	H-51220	9	91740XE	H-8537
67	BT8802-MPG	HC-7606	136	PT207-HD	H-79411	205	PT9261MPG	H-62050	10	91852	H-5001
68	BT8830	HC-7913	137	PT373	H-51170	206	PT9288-MPG	H-62020	11	92115	HC-5516
69	BT8831	HC-7941	138	PT385	H-65030	207	PT93	H-5502	12	92426	H-65030
70	BT8840-MPG	HC-5507	139	PT385E	H-65030	208	PT93	H-5508	13	92434	H-7976
71	BT8841-MPG	HC-76080	140	PT391-MPG	H-76070	209	PT9337-MPG	H-55330	14	92439	H-57030
72	BT8844	HC-7923	141	PT396	H-5611	210	PT9340MPG	H-57030	15	92447	HC-57020
73	BT8846	HC-57020	142	PT397	H-5609	211	PT9351-MPG	H-5629	16	92449	HC-57030
74	BT8847	HC-57030	143	PT400	H-5622	212	PT9352	H-2706	17	92451	HC-57020
75	BT8850-MPG	HC-5508	144	PT434	H-5640	213	PT9354-MPG	H-55420	18	92454	HC-57030
76	BT8851-MPG	HC-5504	145	PT510	H-5618	214	PT9357	H-7101	19	92455	HC-5507
77	BT8851-MPG	HC-55090	146	PT516	H-5607	215	PT9407-MPG	EH-55010	20	92482	HC-7972
78	BT8856MPG	HC-55240	147	PT517	H-5601	216	PT9413-MPG	H-56650	21	92485	HC-7972
79	BT8861	HC-7972	148	PT539	H-5610	217	PT9414-MPG	H-7602	22	92486	HC-55240
80	BT8862	HC-7927	149	PT549	H-7961	218	PT9415-MPG-KIT	H-8537-S	23	92497	HC-57030
81	BT8873	HC-55250	150	PT565	H-5410	219	PT9416-MPG	H-8538	24	92527	H-57030
82	BT8874-MPG	HC-5506	151	PT676	H-42020	220	PT9416-MPG KIT	H-8538-S	25	92543	H-57030
83	BT8875-MPG	HC-55310	152	PT679	H-7972	221	PT9420-MPG	H-56540	26	92544	H-57030
84	BT8876-MPG	HC-5503	153	PT707-HD	H-7976	222	PT9424	H-2712	27	92567	H-79411
85	BT8877MPG	HC-55270	154	PT707-HD3	H-7985	223	PT9448	H-5802	28	92632	HC-55290
86	BT8878-MPG	HC-5512	155	PT708-HD	H-5620	224	PT9459-MPG	H-62120	29	92648	HC-7604
87	BT8879-MPG	HC-7001	156	PT716	H-5902	225	PT9479-MPG	H-51050	30	92697	H-5001
88	BT8886MPG	HC-5516	157	PT7616	H-6301	226	PT9490-MPG	H-62100	31	92720	HC-5505
89	BT8890	HC-5807	158	PT763	H-7905	227	PT9556-MPG	H-5522	32	92731	HC-5506
90	BT8899	HC-45070	159	PT767	H-57030	228	PT9557	H-7981	33	92733	HC-55250
91	BT8902	HC-88010	160	PT768	H-57030	229	PT98-10	H-5509	34	92735	HC-55260
92	BT8906	HC-5602	161	PT83-MPG	H-5506	230	S9475	H-56610	35	92756	HC-62010
93	BT8908	HC-52010	162	PT8319	H-2703	231	WGL9126	H-2717	36	92758	HC-62010
94	BT8932	HC-7915	163	PT8330-MPG	H-53010	BARBER-GREENE			37	92759	HC-5511
95	BT8974-MPG	H-57040	164	PT8341	H-2718	1	5573014	H-65030	38	92818	HC-6217
96	BT9164	HC-79081	165	PT8341	H-5513	2	8T7478	HC-57020	39	92861	HC-19060
97	BT9318	HC-7920	166	PT8350	H-5501	BARKO HYDRAULICS			BLAW-KNOX		
98	BT9346-MPG	HC-76120	167	PT8351	H-2701	1	MB6598903	HC-7972	1	001121601	HC-55290
99	BT9349-MPG	HC-55180	168	PT8352	H-2702	BAUER			2	0011221601	HC-55260
100	BT9353MPG	HC-55280	169	PT8353	H-71140	1	54937	H-62070	3	11221601	HC-55290
101	BT9356	HC-5511	170	PT8354	H-7934	BEAL			BLOUNT		
102	BT9367-MPG	HC-76070	171	PT8359	H-7912	1	3667-354-2400-0/A	HC-47020	1	120088	H-7976
103	BT9371MPG	HC-55290	172	PT8366	H-5505	BEHRINGER FLUID SYSTEMS, INC			2	841334500	H-85110
104	BT9377	HC-5603	173	PT8372	H-5211	1	BS0128S10N38	HC-5511	3	F023753	HC-57020
105	BT9387	HC-51070	174	PT8385	H-7102	BELAZ			BOBCAT		
106	BT9392-MPG	HC-55300	175	PT8387	H-7919	1	6311-1-19	H-85820	1	51850	H-5803
107	BT9400MPG	HC-45030	176	PT8388	H-2704	2	631BN-1-30N	H-85830	2	6516722	HC-1903
108	BT9422	HC-76130	177	PT8392	H-2719	BELL			3	6598903	HC-7927
109	BT9439	HC-45040	178	PT8400-MPG	H-7973	1	220005	H-7941	4	6599543	HC-7923
110	BT9464	HC-9901	179	PT8405-MPG	H-8537	2	220077	HC-7927	5	6653336	HC-7901
111	BT9558-MPG	HC-8502	180	PT8414-MPG	H-71150	BELL EQUIPMENT (SA)			6	6660728	HC-19040
112	BT9561	HC-8501	181	PT8433-MPG	H-71130	1	210469	HC-55260	7	6661248	HC-5507
113	H8080	H-55380	182	PT8436	H-7942	2	BMG07993014	H-5001	8	6670207	HC-5506
114	H9043-V	H-71190	183	PT8459	H-4904	BEMIL			9	6686926	HC-76100
115	H9069	H-7915	184	PT8478	H-2709	1	110HS91608	H-65030	10	6692337	H-88110
116	H9070	H-7974	185	PT8494	H-57030	2	V22854	H-65030	BOMAG		
117	H9073	H-7916	186	PT8515-MPG	H-8537	3	WABCOSP6290	H-65030	1	05730128	HC-55240
118	H9075	H-5001	187	PT8939-MPG	H-6701	4	WABCOSP6298	H-65030	2	07993014	H-5001



Manufacturer's Cross Reference

NO	REFERENCE NO	SAKURA NO	NO	REFERENCE NO	SAKURA NO	NO	REFERENCE NO	SAKURA NO	NO	REFERENCE NO	SAKURA NO
BOMAG			CARQUEST			CASE			CATERPILLAR		
3	30003053	H-65030	15	85447	HC-57020	37	A161845	HC-7909	6	1238189	HC-51020
4	31001946	H-79411	16	85449	HC-57030	38	A165029	HC-5507	7	126-1814	HC-55300
5	31005666	H-57030	17	85451	HC-57020	39	A45625	HC-7933	8	126-1817	HC-5512
6	53531235	HC-55240	18	85454	HC-57030	40	A49386	HC-5506	9	126-2081	H-7942
7	5730128	HC-55240	19	85455	HC-5507	41	D120594	HC-7972	10	126-2081X	H-7942
8	5821213	HC-62020	20	85482	HC-7972	42	D126922	HC-7972	11	1261813	HC-55170
9	5821215	H-5001	21	85485	HC-7972	43	D32212	H-5640	12	1261815	HC-55220
10	5821215	HC-5502	22	85486	HC-55240	44	D43800	H-7936	13	132-8875	H-55270
11	853531151	H-5001	23	85519	HC-7919	45	D43801	H-7936	14	132-8876	H-5526
12	853531235	HC-55240	24	85527	H-57030	46	D52932	H-5109	15	1328876	H-55280
13	96009814	H-85521	25	85535	H-57030	47	D80538	HC-5511	16	134-0964	H-5001
BOMBARDIER			26	85543	H-57030	48	E-73298	HC-8001	17	139-1532	H-5508
1	118302300	HC-57020	27	85544	H-57030	49	J2950563	HC-5506	18	139-1536	H-5506
2	921183023	HC-57020	28	85567	H-79411	50	KHJ 1493	H-5513	19	144-6691	HC-5507
BOSCH			29	85632	HC-55260	51	KSJ2756	H-2727	20	1440832	HC-55290
1	0 451 403 210	HC-5502	30	85648	HC-7604	52	N7332	HC-7927	21	179-9806	H-5522
2	0986B01911	HC-6217	31	85683	H-5001	53	N9025	HC-5508	22	179-9806X	H-5522
3	1457429469	H-65030	32	85720	HC-5505	54	N9086	HC-5506	23	184-3931	HC-5505
4	243360	HC-7972	33	85731	HC-5506	55	P00150521K	HC-6217	24	184-3931	HC-55180
5	9455085023	HC-6217	34	85733	HC-55250	56	P250574	H-71140	25	1850337	HC-5516
6	9457200780	H-65030	35	85758	HC-62010	57	R25844	HC-5511	26	1G-8878	HC-5504
7	ABZFEN0040101XMA	H-62070	36	85759	HC-5511	58	S-62434	H-79411	27	1R-0719	H-5504
8	F 026 404 006	H-7103	37	85818	HC-6217	59	S-89349	H-79411	28	1R-0720	H-5503
BRANSON			38	85861	HC-62010	60	T-40153	H-79411	29	1R-0722	H-5506
1	NTB8030000B3	HC-79540	39	85865	HC-5511	CASE STEYR			30	1R-0728	H-5502
BUHLER MANUFACTURING			40	A20A03GV	HC-55270	1	295950A1	H-6001	31	1R-0730	H-5501
1	00063297	H-57030	41	D37B20GV	H-62030	2	PR50V00002P1P	H-5634	32	1R-0732	H-5509
2	500602	HC-57020	42	D82E10GV	H-62070	CASE-IH CNH			33	1R-0735	H-5510
BUSSE & KUNTZE			43	R18D25C	H-76050	1	104929	H-57030	34	1R-0741	EH-5503
1	HA 029	HC-85210	CARRARO			2	105892	H-57030	35	1R-0741	H-5503
BYRON			1	139413	HC-45050	3	116428	H-57030	36	1R-0746	H-5501
1	41444	HC-5504	2	146569	HC-45050	4	1272051X1	HC-57020	37	1R-0774	H-5506
CAMECO			CASE			5	1302541	HC-45050	38	1R-0778	EH-5503
1	T175002	HC-55090	1	113465C1	HC-69030	6	181167A1	HC-45050	39	1R-1809	EH-55010
CAMOPLAST INDUSTRIAL INCORPORA			2	120594	HC-7972	7	1816114	H-76040	40	2237809	HC-55290
1	118302300	HC-57020	3	121M1-62434	H-79411	8	254686A1	HC-45050	41	2254118	HC-55280
CAN-FLO			4	1266751H2	HC-76080	9	254686A2	HC-45050	42	265-8676	H-5520
1	F25-25N-M	H-7976	5	132575302	HC-5504	10	30565R91	H-65030	43	265-8676	H-55201
2	RSE50-10	HC-5511	6	1328276C1	H-5409	11	3372819R2	H-76050	44	266-7796	H-55370
3	RSE5025	HC-62010	7	133700730095	HC-45160	12	47522804	H-45050	45	2M-3943	H-5504
4	RSE5025F	HC-62010	8	133736C1	H-5410	13	69149C1	HC-62010	46	2P-5834	H-5501
5	RSE5025N	HC-62010	9	1346028C1	HC-5508	14	73133001	HC-42090	47	304-7195	H-55251
6	RSE503	HC-62010	10	150794A1	HC-7940	15	76086226	HC-45030	48	304-7196	H-55360
7	RSE5051	HC-62010	11	159705A1	H-45020	16	80538	HC-62010	49	312140	H-85110
8	RSE505125	HC-62010	12	181167A1	HC-7965	17	84257511	HC-45070	50	31E5-4026	H-5512
9	RSE6025F	HC-62010	13	1931127	HC-45110	18	92451	HC-57020	51	32-9868	H-79411
CAPA			14	1966553C1	HC-7907	19	A165029	HC-57020	52	328-3655	EH-55010
1	93-P8244	HC-7942	15	254353A1	HC-5508	20	A41725	HC-62010	53	338-3540	EH-55010
2	93-P8247	HC-7943	16	254686A1	HC-7965	21	A57857	HC-62010	54	341-6643	HC-5504
3	CH-165L	HC-7916	17	254686A2	HC-7965	22	C1050527	H-76050	55	342449	HC-5511
4	CP-175VL-25	HC-7943	18	279294C91	H-71160	23	CA137713	HC-45050	56	361-7480	H-55400
5	CP-270	HC-7970	19	279294C92	H-71160	24	H1976934	HC-55260	57	362-1163	EH-55040
20	294721A1	HC-76080	20	294721A1	HC-76080	25	H341974	HC-62010	58	3I-0549	HC-7927
CARBOCOL			21	3224623R1	H-5408	26	J0150566	H-62040	59	3I-0582	H-5001
1	4051572	H-5001	22	332202A1	HC-76130	27	L031230	H-65030	60	3I-0589	H-55320
CARQUEST			23	401073R2	H-5410	28	P1050527	H-76050	61	3I-0606	HC-55230
1	84084	HC-5512	24	402219303	HC-6801	29	P150580	H-85110	62	3I-0609	HC-5507
2	84115	HC-5516	25	431145A1	H-6001	30	R14458	H-65030	63	3I-1627	HC-5511
3	84201	HC-76110	26	530144R92	H-5410	31	S104929	H-57030	64	3I-1728	H-55310
4	84220	HC-45050	27	62434	H-79411	32	S105892	H-57030	65	3I-1761	HC-7972
5	84407	H-53010	28	65126C92	H-5410	33	S116428	H-57030	66	3I-1769	HC-55180
6	84608	HC-42090	29	7738743	HC-5511	34	V2950505	H-62070	67	3I0457	H-57030
7	84632	HC-55290	30	84581942	HC-45140	35	V63297	H-57030	68	3I0473	H-57030
8	84709	HC-76070	31	8603535	HC-76130	CATERPILLAR			69	3I0482	H-57030
9	84740	H-8537	32	87353685	H-85560	1	093-7521	HC-5801	70	3I0487	H-57030
10	84740XE	H-8537	33	87519452	HC-76130	2	094-4412	H-5505	71	3I0537	HC-7935
11	84852	H-5001	34	884879C1	H-5640	3	1081153	HC-5503	72	3I0550	HC-57020
12	85426	H-65030	35	93413C1	H-7999	4	109-7293	H-55330	73	3I0553	HC-57030
13	85434	H-7976	36	A-161846	HC-7909	5	120-8757	H-5525	74	3I0567	HC-57020
14	85439	H-57030									



Manufacturer's Cross Reference

NO	REFERENCE NO	SAKURA NO	NO	REFERENCE NO	SAKURA NO	NO	REFERENCE NO	SAKURA NO	NO	REFERENCE NO	SAKURA NO
CATERPILLAR			CATERPILLAR			CLAAS			COMP AIR		
75	310568	HC-55240	144	9T-5664	HC-5511	7	5784640	HC-57020	2	9826250820001	H-55380
76	310582	H-5001	145	9T-6636	HC-55310	8	6339940	HC-62020	3	GD1157245	HC-62010
77	310587	H-55380	146	9T-8578	HC-7602	CLARK			COMPACTION AMERICA		
78	310629	H-57030	147	9T0973	HC-5503	1	062827440	HC-5516	1	0937756	HC-57020
79	310694	HC-5506	148	9T5916	HC-5508	2	1992053	HC-5511	2	1338200	HC-57020
80	310696	HC-55250	149	9U6985	HC-42090	3	215501	H-65030	3	853531151	H-5001
81	310700	HC-55260	150	9W-6428	H-5503	4	230962	H-5109	4	853531225	H-5001
82	310704	HC-62010	151	9W-6428	H-5526	5	234099	HC-7913	COMPRESSORS		
83	310713	H-65030	152	9Y4475	HC-62010	6	23477	H-65030	1	98262/229	HC-7964
84	311172	HC-62010	153	9Y4515	H-65030	7	2366807	HC-7941	CONOCO		
85	311224	H-65030	154	KRJ 5170	H-7913	8	243622	HC-5503	1	CN51758	HC-62010
86	311274	HC-62010	CESSNA			9	243622	HC-55250	COOP		
87	311664	HC-7938	1	62700-20	H-79411	10	244530	H-7961	1	PL436	HC-62010
88	311767	HC-55170	2	62700-200	H-79411	11	2786616	HC-5507	2	UR29	HC-62010
89	311878	HC-55270	3	62700-20C	H-79411	12	290243622	HC-55250	COOPERS		
90	311894	H-7941	4	62700-E	H-79411	13	4148393	H-79411	1	AZH008	H-79411
91	311907	HC-57030	CHAMBERLAIN INC.			14	4202525	HC-51020	2	AZH016	H-42020
92	311914	HC-55290	1	14921	H-65030	15	4303429	H-42020	3	AZH039	H-6301
93	311935	H-62070	CHAMP			16	5575995	H-65030	4	AZH392	HC-7906
94	311939	H-62030	1	1623186	HC-19060	17	5576711	H-65030	5	AZL 128	HC-5502
95	311955	H-7972	2	1718623	H-53010	18	5577106	H-65030	6	G529	H-65030
96	311980	HC-7913	3	24079	HC-19060	19	62827440	HC-5516	7	HEM 6186	H-7102
97	312048	HC-62010	4	37104	HC-5503	20	6505024	H-79411	8	HEM6023	H-6301
98	312140	H-85110	5	49076	HC-5503	21	6505034	H-79411	9	HEM6029	H-79411
99	3S-3865	H-5507	6	LFH8197	HC-19060	22	6516722	HC-1903	10	HEM6035	H-76050
100	3S-3875	H-5507	7	LP-2854	H-7976	23	6519239	HC-62010	11	HEM6040	H-62040
101	3S-3875X	H-5507	8	P-2854	H-7976	24	6552507	HC-62010	12	HET6154	H-65030
102	4I-3948	HC-55180	9	P151	H-65030	25	6591038	HC-5511	13	HSM6008	HC-76110
103	4I-3950	HC-55200	10	PH725	HC-62010	26	6598903	HC-7927	CORMACH		
104	4I3948	HC-5505	CHAMPION			27	6598903	HC-7972	1	8140048	H-85521
105	4J-0816	H-5502	1	1612579	HC-57020	28	6599543	HC-7923	CROSLAND		
106	4J-0816	H-5508	2	37104	HC-5503	29	6630977	HC-5507	1	1A9023	HC-79500
107	4J-6064	H-5503	3	37104	HC-55250	30	6655066	H-2719	2	1A9251	HC-7938
108	4J-6064	H-5526	4	45543	HC-5512	31	6661248	HC-5507	3	1A9253	HC-19060
109	4S-8598	H-5516	5	49076	HC-5503	32	759902	HC-57020	4	2045	HC-62010
110	4T-0522	H-5510	CHAMPION LABORATORIES			33	888331	H-7983	5	341	H-6301
111	4T-0523	H-5510	1	LP151	H-65030	34	896154	H-79411	6	5351	H-65030
112	4T-3130	H-5508	CHAMPION ROAD			35	921796	HC-57020	7	634	H-65030
113	4T-3131	H-55270	1	100459	HC-62010	36	946865	H-79411	8	7002A	H-79411
114	4T-3132	H-55280	2	13028	HC-5511	37	949983	H-79411	9	7012A	H-42020
115	4T-3134	H-5506	3	24079	HC-19060	38	956899	HC-55250	10	7044A	H-42020
116	4T-6788	HC-5511	4	37104	HC-55250	39	965899	HC-55250	11	7052	H-5001
117	4T-7948	HC-5501	CHAR-LYNN			40	M759902	HC-57020	12	7062	H-62040
118	5I-8670	HC-9901	1	5610	HC-7935	41	P173702432140	HC-5516	13	7513	HC-5511
119	5I-8670X	HC-9901	CHARDONNET			CLEVELAND			14	9334	HC-5502
120	5J-8877	H-55390	1	7216061600	H-57030	1	15052	H-65030	CROSS		
121	77-5795	HC-69031	CHARLES MACHINE			2	37104	HC-5503	1	1A9253	HC-19060
122	774375	H-79411	1	148840A	HC-55290	CM FILTER			2	1A9253	HC-62010
123	7J-0670	H-5509	2	149641A	HC-55190	1	CMH4002	H-51220	CTP		
124	7J-670	H-5509	3	149840	HC-55290	CMI			1	1081153	HC-5503
125	7Y-4748	H-7963	4	149939	HC-55170	1	002008500002	HC-57020	CUMMINS		
126	806967	HC-5807	5	149939A	HC-55170	2	2008500002	HC-57020	1	131570	H-65030
127	81010419	H-65030	6	159074	HC-55220	3	285002	HC-57020	2	142897	H-65030
128	841334500	H-85110	7	159383A	HC-55290	4	556500002001	HC-42090	3	181167A1	HC-45050
129	8C3045	HC-57020	8	159383B	HC-55260	5	P2980653368	HC-57020	4	253621	H-65030
130	8I4232	H-7961	CIM-TEX			6	P2980653668	HC-55240	5	254686A1	HC-45050
131	8J-1600	HC-5511	1	400-30	HC-69030	7	P2980653688	HC-55240	CYCLONE		
132	9127515500	H-8525	2	70162	HC-55260	COLES-GROVE			1	PM-1567A	H-79411
133	91375-03800	H-5802	3	70163	HC-55260	1	724896	H-42020	2	PM-K-25	H-7976
134	937520	HC-5801	4	70164	HC-55260	2	G9437100139	H-65030	3	PM436	HC-62010
135	937521	HC-5801	5	70183	HC-42090	COMEX			DAE KEE		
136	937521X	HC-5801	6	70547	HC-62010	1	COMEX	H-5001	1	2423-6005	H-8518
137	94-4412	H-5505	CLAAS			COMMERCIAL FILTER			DAEWOO		
138	994776	H-55350	1	000.363.203.0	HC-5502	1	C926837	H-5001	1	243622	HC-55250
139	997352	H-2718	2	05127430	HC-55240	2	C926840	H-55380	2	24719051	H-2709
140	997352	H-5513	3	211563.3	HC-7907	COMOPLESA-LEBRERO			3	2474-1001	H-2702
141	9J-0750	H-5506	4	3174370	HC-51020	1	750004006	HC-62010	4	2474-9003B	H-2704
142	9J-5461	H-5506	5	363203	HC-5502	COMP AIR			5	2474-9008	H-2704
143	9M-9740	H-5504	6	5127430	HC-55240	1	516 131 0	HC-6801	6	2474-9016A	H-89030



Manufacturer's Cross Reference

NO	REFERENCE NO	SAKURA NO	NO	REFERENCE NO	SAKURA NO	NO	REFERENCE NO	SAKURA NO	NO	REFERENCE NO	SAKURA NO
DAEWOO			DIGOEMA			DONALDSON			DONALDSON		
7	2474-9404A	H-7911	2	DGM/H 7505	H-85940	46	J86-30126	H-7934	115	J86-30830	HC-5902
8	474-00009	H-89050	DITCH WITCH			47	J86-30130	H-5602	116	J86-30840	H-5623
9	54749040	HC-55240	1	155-954	HC-5511	48	J86-30136	HC-8502	117	J86-30847	HC-2704
10	D 501564	H-8902	2	155910	HC-19040	49	J86-30141	H-7979	118	J86-30853	H-5641
11	D140182	HC-5501	3	159-074	HC-5507	50	J86-30143	H-7980	119	J86-30876	HC-79331
12	D140182S	HC-5501	4	159383B	HC-55260	51	J86-30145	HC-5502	120	J86-30906	HC-55270
DAF			5	9700810	HC-57020	52	J86-30165	HC-7916	121	J86-30911	H-5202
1	185 5687	H-71180	DMIC			53	J86-30175	HC-5101	122	J86-30920	H-56580
2	691 954	H-7103	1	D10100BN	H-85521	54	J86-30183	HC-57040	123	J86-30928	H-85570
DAHL			2	D10600ANMG	H-62050	55	J86-30186	H-85770	124	J86-30941	HC-7940
1	301-CS	H-79330	3	DME5C	H-62060	56	J86-30200	H-1001	125	J86-30942	HC-45140
2	DAHL 301-CS	H-79330	4	DRE3B	H-85521	57	J86-30205	HC-5402	126	J86-30950	H-7904
3	DAHL 301-MPG	H-79331	5	DRE5C	H-62060	58	J86-30210	H-1301	127	J86-30951	HC-8804
DANA-SPICER			6	DRE6C	H-62050	59	J86-30212	H-88010	128	J86-30953	H-65010
1	4206169	HC-51020	7	DTE3B	H-85521	60	J86-30216	H-5605	129	J86-30982	HC-85030
2	4209440	HC-45030	8	DTE5C	H-62060	61	J86-30220	HC-7934	130	J86-30993	HC-55200
3	D4209440	HC-45030	9	E605A0006	H-62060	62	J86-30224	H-2706	131	J86-31002	H-2722
DELAWARE MANITOU			DOGUS			63	J86-30234	H-55310	132	J86-31011	H-41013
1	DMS511AN	HC-5511	1	Y1011	H-65030	64	J86-30247	HC-51060	133	J86-31016	H-41012
DELUXE			DOMANGE			65	J86-30250	H-56720	134	J86-31019	H-28040
1	1286	H-79411	1	692764	H-6301	66	J86-30274	HC-76070	135	J86-31020	H-85232
2	286	H-79411	2	FD25P10	H-8515	67	J86-30288	HC-8805	136	J86-31039	H-85810
3	347	HC-62010	3	FD35P25	HC-7907	68	J86-30289	H-48320	137	J86-31040	H-2728
4	WD-347	HC-5511	DONALDSON			69	J86-30301	H-5904	138	J86-31085	H-27321
5	WD347	HC-62010	1	DT83001625UM	H-42260	70	J86-30308	HC-55170	139	J86-31095	HC-60010
DEMAG			2	HF35214	H-62060	71	J86-30311	H-89080	140	J86-31100	H-56600
1	044 252 74	HC-7964	3	HFP55-0388	HC-19060	72	J86-30318	H-41090	141	J86-31116	H-5635
2	04425274	HC-5502	4	J86-10000	HC-5810	73	J86-30331	H-27241	142	J86-31121	HC-58090
3	057 732 74	HC-6801	5	J86-10002	HC-2703	74	J86-30342	HC-45050	143	J86-31130	H-5621
4	42004612	H-8537	6	J86-10008	HC-5806	75	J86-30353	H-2704	144	J86-31141	HC-7901
5	4425274	HC-5502	7	J86-10244	HC-7942	76	J86-30356	H-7940	145	J86-31142	H-7920
6	57 732 74	HC-6801	8	J86-10247	HC-7943	77	J86-30359	HC-7907	146	J86-31145	HC-51020
7	69022273	H-6701	9	J86-10270	HC-7970	78	J86-30379	H-7101	147	J86-31160	H-5651
8	693688	HC-7972	10	J86-10630	HC-7931	79	J86-30383	H-5649	148	J86-31197	H-42230
9	988618	H-65030	11	J86-10751	H-7983	80	J86-30386	HC-51070	149	J86-31200	H-7986
DENSO			12	J86-10837	HC-2701	81	J86-30391	HC-7963	150	J86-31289	H-85560
1	32670-12620	HC-1119	13	J86-11103	HC-1014	82	J86-30393	HC-7929	151	J86-31310	HC-55180
DES CASE			14	J86-11110	HC-5807	83	J86-30400	HC-5802	152	J86-31580	H-85610
1	FCLF	HC-55290	15	J86-13200	HC-47010	84	J86-30407	H-27330	153	J86-31601	HC-79520
2	P6026	HC-55290	16	J86-13300	HC-5804	85	J86-30435	H-2708	154	J86-31615	H-41030
DETROIT DIESEL			17	J86-14201	HC-54040	86	J86-30453	HC-55300	155	J86-31623	HC-88111
1	23519377	H-65030	18	J86-16071	H-59230	87	J86-30470	H-85600	156	J86-31710	HC-5817
2	23519378	H-65030	19	J86-30002	H-7903	88	J86-30482	H-7106	157	J86-31801	H-8401
3	23530414	H-65030	20	J86-30003	H-2707	89	J86-30532	H-56590	158	J86-31816	H-5508
DEUTZ			21	J86-30006	H-7907	90	J86-30546	HC-7922	159	J86-31929	H-85580
1	1173481	HC-1822	22	J86-30007	H-4102	91	J86-30551	HC-19040	160	J86-32001	H-5903
2	2.4419.280.0/10	HC-51040	23	J86-30021	H-56540	92	J86-30555	HC-55240	161	J86-32021	HC-7926
3	2.4419280.0	HC-51040	24	J86-30024	HC-7928	93	J86-30566	H-7906	162	J86-32030	HC-7944
4	4118911	HC-5507	25	J86-30026	HC-76100	94	J86-30567	HC-7001	163	J86-32210	HC-5603
5	74853388	H-57030	26	J86-30030	H-2711	95	J86-30576	H-5520	164	J86-32223	HC-6501
6	PM200641	HC-7972	27	J86-30032	HC-7908	96	J86-30590	H-2713	165	J86-32580	H-7946
DEUTZ-FAHR			28	J86-30040	HC-7909	97	J86-30600	H-5624	166	J86-32591	HC-88030
1	1183600	HC-5502	29	J86-30044	HC-45070	98	J86-30603	HC-5401	167	J86-32711	H-5632
DIAGNETICS			30	J86-30051	HC-7911	99	J86-30612	H-5515	168	J86-32804	HC-7924
1	LPA308B12	H-5001	31	J86-30056	HC-1902	100	J86-30615	H-7919	169	J86-33052	HC-2709
2	LPA308V12	H-5001	32	J86-30062	H-7970	101	J86-30620	H-56530	170	J86-33065	H-27380
3	LPA313B25	H-55380	33	J86-30071	H-5919	102	J86-30623	HC-8811	171	J86-33145	HC-56080
4	LPA313V25	H-55380	34	J86-30075	H-43010	103	J86-30633	H-5615	172	J86-33542	HC-57020
DIAMOND			35	J86-30085	H-71120	104	J86-30651	H-27360	173	J86-33700	H-52050
1	CL73225F	H-42020	36	J86-30086	H-7107	105	J86-30675	HC-5512	174	J86-33710	H-52090
2	CR8030	H-85521	37	J86-30090	H-5514	106	J86-30688	HC-7101	175	J86-34020	HC-79530
3	DH1414	H-7977	38	J86-30102	HC-5815	107	J86-30710	HC-5816	176	J86-34100	H-5628
4	DH2225	H-79411	39	J86-30103	HC-45060	108	J86-30729	HC-76130	177	J86-34121	HC-7974
5	DH61	H-62040	40	J86-30107	H-7901	109	J86-30751	H-45020	178	J86-34160	HC-56060
6	DH8005	H-85110	41	J86-30110	H-7929	110	J86-30753	H-7962	179	J86-35004	H-41080
7	DHR0813	H-76050	42	J86-30111	H-85231	111	J86-30779	H-7960	180	J86-35028	H-71170
8	DHR0813F	H-76040	43	J86-30117	HC-69030	112	J86-30800	H-5802	181	J86-35075	HC-45030
DIGOEMA			44	J86-30122	H-7938	113	J86-30801	HC-5903	182	J86-35080	H-56560
1	DGM/H 31601	H-85920	45	J86-30124	H-2725	114	J86-30803	H-5803	183	J86-35100	H-7902



Manufacturer's Cross Reference

NO	REFERENCE NO	SAKURA NO	NO	REFERENCE NO	SAKURA NO	NO	REFERENCE NO	SAKURA NO	NO	REFERENCE NO	SAKURA NO
DONALDSON			DONALDSON			DONALDSON			DONALDSON		
184	J86-35121	H-56550	253	P167842	H-7916	322	P502247	H-27320	391	P550951	H-65030
185	J86-35170	H-7913	254	P169078	HC-76100	323	P502253	H-2712	392	P551054	H-5607
186	J86-35301	HC-7964	255	P169393	HC-7939	324	P502254	H-2717	393	P551142	H-5609
187	J86-35335	HC-57030	256	P169447	H-5107	325	P502270	H-7981	394	P551158	H-5606
188	J86-35381	HC-5516	257	P17-1621	HC-7907	326	P502292	HC-5602	395	P551160	H-5601
189	J86-35705	HC-55250	258	P170089	HC-55200	327	P502442	H-27340	396	P551203	HC-69030
190	J86-35830	H-85680	259	P170096	H-55310	328	P502443	H-5639	397	P551204	HC-7919
191	J86-35878	HC-51030	260	P170308	HC-55170	329	P502446	H-8523	398	P551205	HC-76090
192	J86-36060	H-79411	261	P170309	HC-55300	330	P502462	H-27241	399	P551210	H-7911
193	J86-36208	HC-55310	262	P170310	HC-55180	331	P502485	H-2727	400	P551211	HC-7909
194	J86-36243	H-42260	263	P170480	HC-5505	332	P502508	H-2712	401	P551242	HC-7606
195	J86-37012	HC-2705	264	P170546	HC-7922	333	P502510	HC-7908	402	P551245	H-2701
196	J86-37047	HC-55090	265	P170599	H-55331	334	P502518	H-56610	403	P551290	H-5620
197	J86-37320	H-5652	266	P170601	H-62070	335	P502519	H-5652	404	P551323	HC-1902
198	J86-37401	HC-69031	267	P170606	H-62030	336	P502520	H-2701	405	P551324	HC-5501
199	J86-37900	H-85800	268	P170608	H-62100	337	P502523	H-7939	406	P551334	H-5505
200	J86-38030	HC-79540	269	P170737	H-53010	338	P502526	H-56600	407	P551342	H-2703
201	J86-38040	HC-7946	270	P170906	HC-55270	339	P502527	HC-5502	408	P551347	H-2718
202	J86-38200	H-60020	271	P171275	HC-69050	340	P502532	H-7983	409	P551347	H-5513
203	J86-38310	HC-52030	272	P171533	H-85520	341	P502540	H-7105	410	P551348	HC-5801
204	J86-38670	HC-9901	273	P171534	H-85521	342	P502561	H-41013	411	P551350	H-8502
205	J86-39130	HC-45110	274	P171561	H-62060	343	P502615	H-62120	412	P551551	HC-19040
206	J86-39300	HC-79081	275	P171573	H-62050	344	P502625	H-85750	413	P551553	HC-1903
207	J86-39530	HC-57041	276	P171622	HC-7966	345	P502626	HC-52030	414	P551757	HC-76110
208	J86-39615	HC-58073	277	P171709	H-42110	346	P505933	HC-7910	415	P551758	TC-7918
209	J86-71876	HC-79372	278	P171802	H-8515	347	P505933	HC-7920	416	P551779	HC-5816
210	P16-5020	H-79411	279	P171825	H-51050	348	P550037	H-7914	417	P552452	HC-5601
211	P160116	H-7905	280	P171828	H-7922	349	P550079	H-5403	418	P552461	HC-7603
212	P162205	HC-5402	281	P172460	H-62040	350	P550082	H-5608	419	P552850	HC-7913
213	P162766	HC-7935	282	P172464	H-85560	351	P550083	H-5622	420	P553161	HC-76140
214	P163323	HC-7972	283	P172465	H-71150	352	P550084	H-5618	421	P553293	H-51170
215	P163324	HC-7927	284	P172466	H-76050	353	P550085	H-5611	422	P555461	H-5506
216	P163419	HC-7923	285	P172467	H-76040	354	P550128	H-5410	423	P555603	H-7601
217	P163439	H-6902	286	P173038	H-7972	355	P550133	H-7936	424	P556001	H-5406
218	P163542	HC-57020	287	P173042	H-42020	356	P550138	H-7941	425	P556064	H-5503
219	P163555	HC-55240	288	P173055	H-85110	357	P550138	H-79411	426	P556064	H-5526
220	P163910	H-5517	289	P173097	H-71130	358	P550148	HC-7906	427	P556700	H-5509
221	P164166	H-5001	290	P173187	H-55332	359	P550220	H-8301	428	P557380	H-5610
222	P164174	H-7975	291	P173188	H-55330	360	P550223	HC-6501	429	P559128	HC-45110
223	P164176	H-55380	292	P173207	H-2704	361	P550223	HC-6502	430	P559740	H-5504
224	P164200	H-55320	293	P173238	H-2703	362	P550229	HC-62020	431	P560971	H-8537
225	P164241	H-5506	294	P173483	H-62010	363	P550230	HC-6802	432	P560972	H-8538
226	P164348	HC-55230	295	P173488	H-7991	364	P550232	H-5640	433	P561183	HC-57040
227	P164352	HC-6901	296	P173489	H-4904	365	P550251	HC-7933	434	P565244	HC-7907
228	P164371	H-69030	297	P173490	H-62020	366	P550251	HC-79331	435	P566197	H-71190
229	P164375	HC-5507	298	P173702	HC-5516	367	P550252	HC-7938	436	P566243	H-42260
230	P164376	HC-5507	299	P174675	HC-51020	368	P550268	HC-7905	437	P566922	HC-7925
231	P164378	HC-5504	300	P175120	H-6701	369	P550276	HC-42090	438	P567580	HC-55280
232	P164381	HC-76080	301	P176208	HC-55310	370	P550308	H-6301	439	P569614	EH-55010
233	P164384	HC-5508	302	P176324	HC-79490	371	P550387	HC-62010	440	P571271	H-5522
234	P164699	H-57030	303	P176325	HC-7973	372	P550388	HC-5511	441	P573354	EH-55010
235	P164906	H-76070	304	P176566	HC-55190	373	P550415	HC-7604	442	P576722	H-5901
236	P165238	H-55270	305	P176567	HC-7001	374	P550416	HC-2701	443	P760155	H-51220
237	P165239	H-55280	306	P177047	HC-55090	375	P550427	H-65010	444	P761108	HC-7920
238	P165335	HC-57030	307	P179096	H-8537	376	P550476	H-5901	445	P762756	H-7102
239	P165354	HC-55220	308	P179342	HC-45050	377	P550477	H-5902	446	P762921	H-2709
240	P165569	HC-5503	309	P179342	HC-7965	378	P550487	H-71160	447	P763577	HC-6217
241	P165659	HC-5506	310	P502082	HC-5801	379	P550523	H-5510	448	P763873	H-48320
242	P165675	HC-5512	311	P502083	HC-5803	380	P550575	H-5506	449	P763956	HC-6801
243	P165705	HC-55250	312	P502084	HC-5806	381	P550576	H-2719	450	P763987	HC-51040
244	P165875	HC-55260	313	P502170	H-7912	382	P550577	H-7942	451	P764729	HC-76130
245	P165876	HC-79372	314	P502172	H-2702	383	P550694	H-5109	452	P765075	HC-45030
246	P165877	HC-7602	315	P502172	H-5614	384	P550699	H-7961	453	P765281	H-7602
247	P167162	HC-55290	316	P502178	H-5507	385	P550700	H-5501	454	P765662	HC-45070
248	P167410	H-5517	317	P502184	H-1015	386	P550701	HC-7941	455	P77-9546	H-79411
249	P167425	H-7976	318	P502215	H-5211	387	P550702	H-2727	456	P77-9585	HC-69030
250	P167514	H-7985	319	P502224	HC-1905	388	P550787	H-5629	457	P77-9599	HC-19060
251	P167829	HC-69031	320	P502227	HC-8001	389	P550816	H-5502	458	P77-9603	HC-7909
252	P167830	HC-7925	321	P502231	HC-7946	390	P550830	H-55420	459	P837228	H-5901



Manufacturer's Cross Reference

NO	REFERENCE NO	SAKURA NO	NO	REFERENCE NO	SAKURA NO	NO	REFERENCE NO	SAKURA NO	NO	REFERENCE NO	SAKURA NO
DONALDSON			DRESSTA			F.B.O			FENDT		
460	P837229	H-5907	1	867-01-0194	H-62080	6	CM18003	H-42110	1	G292 100 471 110	HC-5502
461	P837230	H-5908	DRIL TECH			7	CR1003	H-85521	FENGYE FILTERS		
462	P837231	H-5902	1	002372-55	H-79411	8	CR33002	H-62060	1	FHJ-501	H-53010
463	P837232	H-5905	2	040006451	HC-55240	9	CR60002	H-62050	2	FJX-213	HC-6217
464	P837354	H-5910	3	04698884	HC-55250	10	CRS30002	H-62040	FES		
465	P837516	H-5910	4	40006451	HC-55240	11	CRS30003	H-62040	1	130000910001	HC-55250
466	P845437	H-59200	5	73831130	HC-57020	12	CRS3001	H-62040	FHAS		
467	P845444	H-59210	DROTT			13	CRS3003	H-62040	1	FH1336	H-28040
468	P845490	H-59220	1	121-M1-62434	H-79411	14	CRS3903	H-85110	FIAAM		
469	P845816	H-59230	2	62434	H-79411	15	CRS49002	H-76040	1	FA-4856	H-6301
470	P845962	H-5910	DYNACRAFT			16	CRS4901	H-76050	2	FT4940	HC-5502
471	P905578	H-5503	1	100-853-1	H-79411	17	CRS90/1	H-8515	FIAT		
472	P905578	H-5526	2	45-347P	H-79411	FACET			1	1816114	H-76040
473	P905580	H-5504	DYNAHOE			1	1742558	H-8535	2	1901608	H-65030
474	R010044	H-89030	1	45-347P	H-79411	FAIREY ARLON			3	1909130	HC-45110
475	R010045	H-85700	DYNAPAC			1	270-L-123	H-8542	4	1930779	H-65030
476	R010046	H-85670	1	00081339	HC-57020	2	370L110A	H-7972	5	4287634	H-2709
477	R010048	H-85710	2	196444	HC-55250	3	370L210	H-42020	6	4853388	H-57030
478	R010050	H-85720	3	196446	HC-55250	4	370L210A	H-42020	7	70185691	H-65030
479	R010051	H-85590	4	372229	HC-55190	5	370L223	H-42020	8	70188056	H-65030
480	R010055	H-85730	5	964725500	H-62030	6	370L223A	H-42020	9	70248399	HC-1903
481	R010064	H-38020	EATON			7	370Z210A	H-42020	10	710049229	H-7961
482	R010065	H-42140	1	6955207	H-65030	8	370Z223	H-42020	11	71316231	H-62040
483	R010066	H-42150	EIMCO			9	370Z223A	H-42020	12	71402469	H-2703
484	R010067	H-42120	1	04698884	HC-55250	10	CG465	HC-57020	13	71402547	H-2704
485	R010073	H-42160	2	103347	H-65030	11	CG46CC16	HC-5507	14	71407523	H-2715
486	R010079	H-38030	3	64103347	H-65030	12	CG495	HC-55240	15	71416241	H-7911
487	R010080	H-42170	4	64115773	H-5001	13	FA57CC10	HC-55260	16	7219713	H-5505
488	R010081	H-71170	5	69008895	H-55380	14	MB6A	H-62040	17	7295093	H-7990
489	R010082	H-38010	6	CL243622	HC-55250	15	R160HBH10A	H-62030	18	72950937	H-7990
490	R010083	H-42180	7	D2NP163323	HC-7972	16	R750H0406A	HC-55290	19	73131887	HC-7972
491	R010084	H-42190	ELGIN SWEEPER			17	R750H0412A	HC-55260	20	73133001	HC-42090
492	R010085	H-27321	1	7071030	HC-5511	18	R830H1625A	H-42260	21	74369988	H-65030
493	R010086	H-85570	ENMTP CPG			19	R960H0812A	H-5001	22	74853388	H-57030
494	R010089	H-28050	1	5603559	H-55380	20	R960H1325A	H-55380	23	76074218	HC-76080
495	R010090	H-27251	EPPENSTEINER			21	R960Z0812A	H-5001	24	76580323	H-2709
496	R010096	H-85810	1	11.400P25	H-6301	22	R960Z1320A	H-55380	25	78511592	HC-7972
497	R010101	H-42250	2	12.15P10	H-8515	23	R960Z1325A	H-55380	26	906041007	HC-7913
498	R010102	H-85770	3	50SL80DP5	HC-7972	24	TX310	H-8515	FIAT-ALLIS		
499	R010103	H-42230	4	7SL130P25P	HC-7907	25	TX8A10	H-85110	1	019878	H-7976
500	R010107	H-42240	5	80.13P25S00-0-P	HC-7907	26	TXW5AGDL10	H-7922	2	190020	H-7976
501	R010109	H-2725	EUCLID			27	TXW6ACC10	H-62040	3	1978782	H-7976
502	SFH 0085	H-27321	1	0965899	HC-55250	28	TXW6ACC25	H-62040	4	70190020	H-7976
DOOSAN			2	12597989	HC-55260	29	TXW8C10	H-76040	5	70197878	H-7976
1	15265318	H-41090	3	12597989	HC-7602	30	TXW8CCC10	H-76040	6	71007060	H-79411
2	24719401A	H-27321	4	2155026	H-65030	31	TXW8CGDL10	H-76040	FILITRONIC		
3	2474-1003A	H-7912	5	2675189	H-65030	32	TXX310	H-8515	1	118YH	H-65030
4	2474-9016A	H-89030	6	4051572	H-5001	33	TXX6A10	H-62040	FILMAR FILTER		
5	400504-00240	H-89060	7	5572942	H-65030	34	TXX8C10	H-76050	1	SO8208H	HC-6217
6	400504-00241	H-89070	8	5577106	H-65030	FAIREYAR			FILPRO		
7	474-00046	H-52190	9	62413976	H-76050	1	370L123A	H-7972	1	SOE15-25	HC-7907
8	474-00056	H-52200	10	9038953	H-65010	2	370L123GDH20	H-7972	FILREC		
9	A383013	HC-69040	11	9066151	H-57030	FAMEL			1	A150G06	HC-55290
10	K9005928	H-85570	12	9658998	HC-55250	1	FA202H	H-57030	2	A150G10	HC-55260
11	K9005929	H-85580	13	E12597989	HC-55260	FARID INDUSTRIE			3	CCH802FD1	H-5001
12	OM631-1	H-89080	14	E12597989	HC-7602	1	927007007	H-85521	4	CCH803FV1	H-55380
DRESSER			15	M0965899	HC-55250	FARR			5	D141G10A	H-5001
1	117900	H-65030	EUROTECHNIC FILTER			1	1211122522600	HC-62020	6	D142G25A	H-55380
2	129748	H-57030	1	E2430-1696	HC-7920	2	1211122522601	HC-62020	7	D311G25A	H-42110
3	131470	H-65030	EVOBUS/SETRA			3	1211122522602	HC-62020	8	R122C25B	H-85521
4	302565R91	H-65030	1	8.321.999.533.0	H-7102	FAUN			9	R164G10B	H-62050
5	3800005Y9	HC-55260	EXCEL			1	1695782	H-62040	10	R730C10	H-62040
6	60805002	HC-55260	1	26633	HC-5511	2	4134365	H-76050	11	R730C25	H-62040
7	612724C91	H-65030	F.B.O			3	4134431	H-71140	12	R731C10	H-85110
8	A33	H-65030	1	47552	H-5001	4	7391047	H-65030	13	R731C25	H-85110
9	S58MG	HC-55260	2	47653	H-55380	5	HY504601	H-85920	14	R732C10	H-76050
10	VE0452	H-5001	3	AP40553	H-42020	FAUN-FRISCH(O+K)			15	R732C25	H-76050
11	VE4452	H-5001	4	AP48452	H-62030	1	7381-004	HC-76110	16	R732G10	H-76040
DRESSTA			5	CA200/3	HC-7907	2	7395-819	HC-76110	FILT		



Manufacturer's Cross Reference

NO	REFERENCE NO	SAKURA NO	NO	REFERENCE NO	SAKURA NO	NO	REFERENCE NO	SAKURA NO	NO	REFERENCE NO	SAKURA NO
FILT			FLEETGUARD			FLEETGUARD			FLEETGUARD		
1	FF435	H-6301	28	HF28943	H-8537-S	97	HF35457	H-55270	166	HF6306	H-8515
2	FF505	H-65030	29	HF28945	HC-52010	98	HF35464	HC-45030	167	HF6311	H-76050
FILTEC			30	HF28946	H-7956	99	HF35477	HC-57040	168	HF6316	HC-76110
1	R730C10	H-62040	31	HF28951	H-5907	100	HF35480	EH-55010	169	HF6317	HC-2701
2	R730C25	H-62040	32	HF28952	HC-8001	101	HF35482	H-56650	170	HF6319	H-7911
FILTER FINDER			33	HF28975	H-5609	102	HF35498	HC-76130	171	HF6320	H-7961
1	HF0617700	HC-7906	34	HF28977	H-56600	103	HF35499	H-7107	172	HF6324	H-6301
2	HF0795400	H-2703	35	HF28978	H-85680	104	HF35510	H-7106	173	HF6337	HC-5501
FILTER PRODUCTS			36	HF28988	H-8522	105	HF35513	H-71120	174	HF6338	HC-7939
1	FPE70100M	HC-42090	37	HF28989	HC-62020	106	HF35516	HC-2709	175	HF6341	H-55270
FILTRAUTO UK			38	HF28993	HC-55200	107	HF35549	H-5802	176	HF6342	H-55280
1	5351	H-65030	39	HF28996	HC-51020	108	HF35553	H-62110	177	HF6344	H-5506
2	634	H-65030	40	HF29033	HC-76070	109	HF6000	H-5410	178	HF6350	HC-51040
3	7012A	H-42020	41	HF30036	H-7974	110	HF6003	HC-7935	179	HF6352	TC-7918
4	7044A	H-42020	42	HF30187	H-62070	111	HF6011	H-7936	180	HF6354	H-5607
5	7052	H-5001	43	HF30196	H-5107	112	HF6057	HC-1903	181	HF6355	HC-5502
FILTREC			44	HF30200	H-71190	113	HF6059	H-51170	182	HF6356	H-5609
1	A421G03V	HC-55270	45	HF30222	H-62100	114	HF6060	H-79411	183	HF6359	HC-7907
2	AWP-105	HC-85190	46	HF30262	H-5001	115	HF6061	H-5406	184	HF6365	H-5501
3	D931G10	H-42020	47	HF30402	H-7915	116	HF6072	H-5606	185	HF6366	HC-7941
4	D931G25A	H-42020	48	HF30453	H-7916	117	HF6079	H-7601	186	HF6376	H-5510
5	DHD160G10B	H-62030	49	HF30524	H-7917	118	HF6083	H-5509	187	HF6389	H-53010
6	DHD160G20V	H-62030	50	HF30700	H-7972	119	HF6084	H-5620	188	HF6420	HC-7913
7	DHD240G10B	H-62100	51	HF30724	H-42020	120	HF6088	H-65030	189	HF6424	HC-85030
8	DHD60G10	H-62070	52	HF30779	H-55380	121	HF6090	H-5611	190	HF6436	HC-55260
9	DHD60G10B	H-62070	53	HF35003	HC-5402	122	HF6091	H-5640	191	HF6483	H-76070
10	R714G10	H-51050	54	HF35004	HC-55310	123	HF6094	H-5405	192	HF6518	HC-55190
11	WG633	H-62120	55	HF35005	H-5622	124	HF6097	H-5504	193	HF6520	HC-19040
FINN			56	HF35006	HC-76100	125	HF6098	H-5503	194	HF6547	HC-5506
1	FFKPV15011B25	H-42020	57	HF35018	HC-5801	126	HF6101	H-5610	195	HF6550	HC-55220
2	FFKPV1700610	H-5001	58	HF35021	H-57030	127	HF6102	H-5610	196	HF6552	HC-5507
3	FFKPV17007	H-55380	59	HF35076	HC-5502	128	HF6109	H-7985	197	HF6553	HC-5504
4	FFKPV1700725	H-55380	60	HF35077	HC-6803	129	HF6110	H-5517	198	HF6553	HC-55090
5	FFKPV1720110ABS	H-62070	61	HF35101	H-5526	130	HF6111	H-7976	199	HF6554	HC-76080
6	FFPA1101	H-85521	62	HF35121	H-51050	131	HF6113	H-7972	200	HF6555	HC-5508
7	FFPA11018	H-85521	63	HF35130	H-48320	132	HF6115	HC-1902	201	HF6556	HC-57030
8	FFPA1103810	H-62040	64	HF35139	HC-8501	133	HF6117	HC-69030	202	HF6561	HC-7972
9	FFPA1109510	H-62040	65	HF35140	HC-76130	134	HF6118	H-65030	203	HF6562	HC-57020
10	FFPA1109910	H-76050	66	HF35150	HC-45050	135	HF6120	HC-7919	204	HF6563	HC-7972
FISPA			67	HF35153	H-8538	136	HF6135	HC-7938	205	HF6564	HC-7923
1	LI2802	H-85521	68	HF35160	H-4903	137	HF6136	HC-19060	206	HF6565	HC-7927
FLEETGUARD			69	HF35195	H-7942	138	HF6140	HC-7909	207	HF6568	HC-57030
1	393755S	H-55420	70	HF35198	H-7602	139	HF6141	HC-6802	208	HF6572	HC-57020
2	HF28731	HC-76090	71	HF35205	H-85521	140	HF6151	H-5403	209	HF6573	HC-55240
3	HF28794	H-4904	72	HF35214	H-62060	141	HF6159	HC-1822	210	HF6578	HC-57030
4	HF28798	H-85680	73	HF35252	H-6701	142	HF6177	HC-7906	211	HF6586	HC-5503
5	HF28803	H-85560	74	HF35255	H-5618	143	HF6180	H-71140	212	HF6587	HC-5506
6	HF28805	H-71130	75	HF35255	H-5651	144	HF6181	H-62040	213	HF6588	HC-5512
7	HF28810	HC-5511	76	HF35258	H-5409	145	HF6182	H-85110	214	HF6603	HC-69031
8	HF28812	HC-5101	77	HF35274	HC-5816	146	HF6184	H-76060	215	HF6610	HC-7925
9	HF28835	H-2712	78	HF35276	H-5901	147	HF6196	H-5608	216	HF6625	HC-7925
10	HF28836	H-2719	79	HF35279	H-57030	148	HF6198	H-5109	217	HF6626	HC-7939
11	HF28850	HC-7940	80	HF35295	H-5408	149	HF6199	H-7905	218	HF6700SYN	HC-55260
12	HF28858	H-7991	81	HF35302	H-62050	150	HF6201	H-5508	219	HF6710	HC-5511
13	HF28879	H-2730	82	HF35315	HC-7924	151	HF6202	H-5506	220	HF6711	HC-79331
14	HF28885	HC-1905	83	HF35315	HC-7946	152	HF6203	HC-7901	221	HF6712	HC-55260
15	HF28893	HC-5601	84	HF35355	HC-55170	153	HF6205	HC-6217	222	HF6720	HC-62010
16	HF28894	HC-5603	85	HF35360	H-5629	154	HF6213	H-5601	223	HF6723	HC-42090
17	HF28910	H-2709	86	HF35363	H-2725	155	HF6225	H-65030	224	HF6730	HC-55260
18	HF28913	H-5625	87	HF35367	H-62120	156	HF6237	H-7983	225	HF6737	HC-55260
19	HF28917	H-8301	88	HF35374	H-5639	157	HF6243	HC-6501	226	HF6777	HC-55290
20	HF28925	H-2706	89	HF35377	H-85520	158	HF6246	H-62010	227	HF6779	HC-55260
21	HF28926	H-56610	90	HF35381	HC-5516	159	HF6247	H-62020	228	HF6780	HC-7937
22	HF28928	H-5652	91	HF35438	HC-7922	160	HF6269	HC-6901	229	HF6781	HC-7602
23	HF28931	H-2714	92	HF35440	H-5522	161	HF6287	H-57030	230	HF6802	HC-7606
24	HF28936	H-7996	93	HF35449	H-7101	162	HF6290	H-57030	231	HF6809	HC-7604
25	HF28937	H-8537	94	HF35451	H-5510	163	HF6294	H-57030	232	HF6822	HC-7973
26	HF28938	HC-5505	95	HF35453	HC-55300	164	HF6295	H-57030	233	HF6833	HC-7603
27	HF28938	HC-55180	96	HF35456	H-5513	165	HF6305	H-7914	234	HF6861	H-55331



Manufacturer's Cross Reference

NO	REFERENCE NO	SAKURA NO	NO	REFERENCE NO	SAKURA NO	NO	REFERENCE NO	SAKURA NO	NO	REFERENCE NO	SAKURA NO
FLEETGUARD			FLEETRITE			FORD FARM			FRAM		
235	HF7064	H-7915	24	HFR86588	HC-5512	1	SFD-01-4988	H-79411	57	P7565	HC-55250
236	HF7065	H-7974	25	HFR86589	HC-55250	FORDFINISCODE			58	P8307	HC-5505
237	HF7068	H-7916	26	HFR86706	HC-55260	1	3912256	HC-1901	59	P8552	HC-76110
238	HF7070	H-5001	27	HFR86712	HC-55260	2	81865736	HC-1905	60	P8595	HC-7604
239	HF7071	H-7975	28	HFR86723	HC-42090	FOTON			61	PH3335	HC-5502
240	HF7072	H-7917	29	HFR86730	HC-55260	1	9F653-31A020200A0	H-38050	62	PH4481	HC-51040
241	HF7075	H-55380	30	HFR86777	HC-55260	FPC			FREIGHTLINER		
242	HF7102	H-5107	31	HFR86779	HC-55260	1	FPE5005G	HC-55290	1	DNP164166	H-5001
243	HF7479	H-69030	32	HFR87070	H-5001	2	FPE5010G	HC-55260	2	DNP165705	HC-55250
244	HF7535	HC-7920	33	HFR87075	H-55380	3	FPE70100M	HC-42090	3	DNP170601	H-62070
245	HF7541	HC-79081	34	HFR87550	HC-45050	FRAD			4	DNP550951	H-65030
246	HF7551	HC-8805	35	HFR87996	HC-55260	1	36.18.04/110	HC-6217	FSA		
247	HF7569	HC-45110	36	HFR88075	H-55380	FRAM			1	EH5503	EH-5503
248	HF7691	H-7981	FLO-LINE			1	C-1703	H-79411	2	FO1101	HC-7906
249	HF7725	H-55310	1	Q-K25	H-7976	2	C-4648	H-6301	3	FO1771	H-5504
250	HF7920	H-2701	FLOW EZY			3	C1664	H-5405	4	FO1783	H-5506
251	HF7921	H-2704	1	6583-05	H-7976	4	C1672	H-79411	5	FO1824	H-5609
252	HF7923	H-5505	FLUID CONTROL SERVICES			5	C1679	H-5640	6	FO1830	H-5620
253	HF7927	H-5902	1	FC1056	HC-55260	6	C1682	H-7976	7	FO1854	H-5502
254	HF7928	H-5901	FLUITEX			7	C1686	H-65030	8	FO1927	H-5501
255	HF7935	HC-5602	1	H3709-20M191	HC-6217	8	C1702	H-5517	9	H7941	H-7941
256	HF7950	HC-51070	2	H5009-25M26	HC-19060	9	C5341	H-62040	10	HC7932	HC-7932
257	HF7954	H-2703	3	H51072D26	HC-55290	10	C6984	H-57030	11	HC8001	HC-8001
258	HF7955	HC-7901	4	H51072M26	HC-55290	11	C6988	H-57030	FULLER		
259	HF7956	H-5211	5	H51073D26	HC-55260	12	C6991	H-57030	1	A2471	H-65030
260	HF7961	H-7922	6	H51073M26	HC-55260	13	C6992	H-57030	FUNK		
261	HF7962	H-62040	7	H5111149M26	HC-42090	14	C7053	HC-6217	1	T175002	HC-55090
262	HF7964	H-76040	8	P0310813S61	H-5001	15	C7379	H-5001	FURUKAWA		
263	HF7968	HC-6801	9	P03112810D61B	H-55380	16	C7390	H-57030	1	05018-04002	H-7903
264	HF7981	H-51220	10	P03112810S61	H-55380	17	C8763	H-55320	2	0755119UA	HC-5807
265	HF7990	HC-5807	11	P3909-30B7	H-7976	18	C8884	H-7102	3	1233914H2	HC-7603
266	HF7992	H-7973	12	P4507-30S7	H-79411	19	C9031	H-8537	4	131470	H-65030
267	HF7999	H-7102	FLUXFILTER			20	C9243	H-7996	5	302565R91	H-65030
268	HF8075	H-55380	1	HC1672	H-79411	21	C9243	H-8538	6	3373034R21	H-76050
269	HF8084	HC-51060	FLXIBLE			22	C9243	H-8538-S	7	612724C91	H-65030
270	LF1606	HC-76140	1	5573014	H-65030	23	CH155PL	H-5504	8	91004-10021	HC-5807
271	LF35013	H-6902	FMC			24	CH1652PL	H-65030	G.U.D.(SOUTH AFRICA)		
272	LF3566	HC-5502	1	3J8075	H-57030	25	CH1725	H-65030	1	G973	H-6301
273	LF634	H-71160	FODEN			26	CH1725G	H-65030	GALION		
274	ST1207	H-62080	1	Y02274510	H-65030	27	F-1671-1	H-79411	1	D129748	H-57030
275	ST1659	H-7105	2	Y05762009	H-5001	28	F-1671-V15-1	H-79411	GARDNER DENVER		
FLEETLIFE			3	Y05773707	H-55380	29	F-1671-V15-C1	H-79411	1	5991132	H-57030
1	97520500235	H-65030	4	Y05808004	H-85521	30	F-1671-V5-1	H-79411	2	701701251	H-79411
2	HFR828943	H-8537	FORCE AMERICA			31	F-1671-V5-C1	H-79411	GEHL		
3	HFR86809	HC-7604	1	F501125C	HC-19060	32	F-1672-1	H-79411	1	074830	HC-5504
FLEETRITE			FORD			33	F-1672-V15-1	H-79411	2	137359	HC-7001
1	HFR828938	HC-5505	1	163076	H-79411	34	F-1672-V15-C1	H-79411	3	61511	HC-1903
2	HFR828943	H-8537	2	7700040	H-1903	35	F-1672-V5-1	H-79411	4	N193024	HC-52010
3	HFR828961	HC-55260	3	9576P160216	H-57030	36	F-1672-V5-C1	H-79411	GEMSA GENERAL MAKINA SAN		
4	HFR830779	H-55380	4	9576P160516	H-57030	37	F-1703-1	H-79411	1	CR100/3	H-85521
5	HFR835021	H-57030	5	9576P163323	HC-7972	38	F-1703V15-1	H-79411	GENERAL MOTORS		
6	HFR835150	HC-45050	6	9576P163428	HC-57030	39	F-1703V15-C1	H-79411	1	23040988	H-53010
7	HFR835271	H-6701	7	9576P163542	HC-57020	40	F-1703V5-1	H-79411	2	23042062	HC-69031
8	HFR86118	H-65030	8	9576P163555	HC-55240	41	F-1703V5-C1	H-79411	3	25010643	HC-6501
9	HFR86225	H-65030	9	9576P164699	H-57030	42	P1654A	HC-1903	4	25010643	HC-6502
10	HFR86270	H-65030	10	9576P165705	HC-55250	43	P1654A	HC-79500	5	25010836	H-65030
11	HFR86287	H-57030	11	9576P170606	H-62030	44	P3780	HC-19060	6	25010961	HC-7935
12	HFR86290	H-57030	12	9576P550276	HC-42090	45	P4596	H-7102	7	25011193	H-65030
13	HFR86294	H-57030	13	9576P550951	H-65030	46	P4637	HC-1901	8	25011194	H-65030
14	HFR86373	H-65030	14	CONN8951B	HC-1903	47	P6873	HC-57020	9	25012488	HC-7938
15	HFR86517	HC-5507	15	D3NN7C045A	H-5109	48	P6876	HC-57030	10	25012931	H-65030
16	HFR86518	HC-57030	16	D6NN-B486 CA	HC-1901	49	P6877	HC-57020	11	25013194	H-65030
17	HFR86552	HC-5507	17	D8NN-B486 CA	HC-1901	50	P6879	HC-57030	12	25013931	H-65030
18	HFR86556	HC-57030	18	E7NN6714FA	HC-7901	51	P6883	HC-7972	13	29540494	H-8537-S
19	HFR86562	HC-57020	19	E8NNF882BA	H-5001	52	P6884	HC-7972	14	5011193	H-65030
20	HFR86572	HC-57020	20	F0NN6714CA12	HC-5504	53	P6888	HC-55240	15	5573014	H-65030
21	HFR86573	HC-55240	21	F2NNF882M	H-5001	54	P7084	HC-5506	16	5573102	H-65030
22	HFR86578	HC-57030	22	F0NN B486 BB	HC-1905	55	P7252	HC-55290	17	5575995	H-65030
23	HFR86587	HC-5506	23	SFD-014-988	H-79411	56	P7320	HC-57030	18	5576199	H-65030



Manufacturer's Cross Reference

NO	REFERENCE NO	SAKURA NO	NO	REFERENCE NO	SAKURA NO	NO	REFERENCE NO	SAKURA NO	NO	REFERENCE NO	SAKURA NO
GENERAL MOTORS			GREYFRIARS			HASTINGS			HITACHI		
19	5577106	H-65030	2	GHF7001	H-79411	27	P-724	H-79411	2	17C77012	HC-2705
20	5577108	H-65030	3	GHF7002	H-79411	28	P-758	H-7976	3	1930779	H-65030
21	6438209	H-65030	4	GHF7114	H-57030	29	P-770	HC-19060	4	24464119	H-5208
22	6438590	H-65030	5	HF9802FD11	H-5001	30	P219	H-65030	5	315041	H-2701
23	6439400	H-65030	6	HS7628	HC-55260	HÁTRA			6	3501403	H-2707
24	6439658	HC-5502	7	HS7675	HC-57020	1	0002005216	H-6301	7	3502410-N	H-7912
25	9038953	H-65010	8	HS7689	HC-55260	HAVAM			8	4050731	H-7911
26	9066151	H-57030	GROVE-MANLIFT			1	26470	H-76050	9	4156753	H-7962
GFK			1	1004512	H-57030	2	HD0105	H-65030	10	4157882	H-7105
1	PSL0896B012	H-5001	2	4270670	HC-57020	3	HD0235	H-65030	11	4159320	H-2702
2	PSL0896B212	H-5001	3	4272920	H-5001	4	HD0546	HC-7922	12	4180416	H-7911
3	PSL1396B025	H-55380	4	7437000175	H-57030	5	HD2460	HC-62040	13	4185299	H-2730
GILLIG			5	7437000176	H-57030	6	HD8780	H-57030	14	4190987	H-2714
1	5322412002	HC-7909	6	7437000177	H-57030	7	HD8810	HC-57020	15	4205684	HC-5602
GMC TRUCK			7	7437000873	HC-51020	8	HD8822	HC-55250	16	4206705	H-2727
1	25012422	HC-19060	8	9437100249	H-57030	9	HD8950	H-5001	17	4207841	H-2703
2	25012531	HC-7909	9	9437100555	HC-55250	HEAVY DUTY AIR			18	4207841A	H-2703
3	6436860	H-79411	10	A104120	HC-57020	1	A15014	H-65030	19	4210224	H-2706
4	6436861	H-79411	GUANGXI LIUGONG MACHINERY			2	H-926899	H-7976	20	4219713	H-5505
GOLDEN FILTER			1	53C0005	H-38020	3	HEP-224-1	H-79411	21	4225846	H-2705
1	PF435	H-6301	2	53C0006	H-85700	HEIL			22	4227353	H-2704
GONHER			3	53C0008	H-38020	1	5572942	H-65030	23	4230376	HC-2701
1	G-172	H-79411	4	53C0011	H-85720	HEIN WERNER			24	4237660	H-27320
2	G-24	H-8515	5	53C0035	H-85670	1	452850	H-57030	25	4285577	H-2716
3	G163	H-65030	6	53C0197	H-38040	HELI			26	4286837	HC-2701
GRACO INC			7	53C0250	H-85730	1	25597-60301G	H-5904	27	4287061	H-2727
1	15D702	HC-5516	GUARDIAN			2	A22A2-20701	H-79370	28	4287634	H-2709
GRADALL			1	G05-1434	H-7976	HENGST			29	4294130	H-2712
1	76102474	H-57030	GUD FILTERS			1	E230H	H-65030	30	4294132	H-2717
2	77133069	H-57030	1	AG873	H-6301	2	E39H	H-7102	31	4294135	H-2719
3	90202212	H-57030	2	Z 184	HC-5502	3	E39H	H-7103	32	4325820	H-2727
GRASO AIR			GUIOT			4	E39H	H-7104	33	4333469	H-2709
1	0711372	H-8515	1	GE.1671	H-79411	5	E39H D120	H-7103	34	4358407	H-27330
GRESEN			GULDNER			6	E39H D131	H-7104	35	4363399	HC-7901
1	1566	H-79411	1	000 983 0623	HC-6803	7	E39HD119	H-7102	36	4370435	H-2703
2	1566	H-79411	2	9830618	HC-6803	8	E48H	H-5506	37	4370435	H-2708
3	1567	H-79411	3	9830623	HC-6803	9	E54H	H-5509	38	4385915	H-2706
4	1597	H-79411	HAMM (WIRTGENGROUP)			10	E59H	H-6301	39	4402914	H-27340
5	3144	H-79411	1	1285491	H-85750	11	E90H D149	H-85520	40	4443773	H-7981
6	3278	H-79411	HANGCHA			12	H17W22	HC-7901	41	4448401	H-2721
7	3278-001	H-79411	1	70022095	H-85490	13	H17WD03	HC-76110	42	4448402	H-7981
8	3279-001	H-79411	2	N163-603400-000	H-85490	14	H24W05	HC-7910	43	4450002	H-2722
9	3280-001	H-79411	HASTINGS			15	H300W04	HC-5502	44	4488239	H-2720
10	3294	H-79411	1	BT8439MPG	HC-45050	16	H300WD01	HC-5502	45	4489239	H-2721
11	3294-001	H-79411	2	FP219	H-65030	HENLEY			46	4508505	H-2704
12	8057000	HC-79500	3	H9075	H-5001	1	T68010001	H-65030	47	45775779-1	H-7960
13	CL23012	H-79411	4	HF-724	H-79411	HERKULES (TELSNIG)			48	4630525	HC-2709
14	F403	H-79411	5	HF-758	H-7976	1	290305A	H-65030	49	4648651	H-27360
15	FR253	H-79411	6	HF-770	HC-19060	HIAB			50	4656605	H-2724
16	K-23001	H-79411	7	HF718	HC-7972	1	5955068	H-8515	51	4656608	H-2724
17	K-23004	H-79411	8	HF719	HC-7972	2	9961941	H-8515	52	4656609	H-27241
18	K-23012	H-79411	9	HF825	HC-57020	HIFI			53	4683331	H-27241
19	K-23014	H-79411	10	HF842	H-57030	1	SH 60084	HC-7914	54	4711728	H-5633
20	K-23027	H-79411	11	HF843	H-57030	2	SH 60184	HC-8811	55	4853388	H-57030
21	K-23035	H-79411	12	HF863	HC-57030	3	SH 60236	HC-2709	56	4857186	H-5206
22	K-23040	H-79411	13	HF871	HC-55240	4	SH 60407	HC-69040	57	573330	H-5206
23	K-24005	H-79411	14	HF876	HC-57030	5	SH 60568	HC-56080	58	673330	H-5206
24	K-24007	H-79411	15	HF894	H-57030	6	SH 62061	HC-85210	59	673340	H-5803
25	K-24014	H-79411	16	HF940	HC-55260	7	SH 66284	HC-76150	60	70022104	H-65030
26	K-25007	H-79411	17	HF942	HC-55250	8	SH 66286	HC-45140	61	70059792	H-65030
27	K23018	HC-5511	18	HF943	HC-5506	9	SH56161	H-7976	62	70079325	H-65030
28	LF203	H-79411	19	HF944	HC-5505	10	SH56255	HC-6217	63	70079352	H-65030
29	LSP05	HC-7933	20	HF957	H-53010	11	T 601	HC-47020	64	70081733	H-65030
30	RFA-203	H-79411	21	HF960	HC-7604	HINO			65	70090828	H-65030
31	RFB-203	H-79411	22	HF987	HC-76110	1	44308-1210	H-1301	66	70185691	H-65030
32	SF203	H-79411	23	LF228	H-57030	HIRSCHI			67	701856915	H-65030
33	ST203	H-79411	24	LF545	HC-6217	1	SH 62061	HC-85210	68	70188056	H-65030
GREYFRIARS			25	P-711	H-79411	HITACHI			69	701880566	H-65030
1	700P	H-42020	26	P-711A	H-79411	1	17C69847	HC-2704	70	70197121	H-65030



Manufacturer's Cross Reference

NO	REFERENCE NO	SAKURA NO	NO	REFERENCE NO	SAKURA NO	NO	REFERENCE NO	SAKURA NO	NO	REFERENCE NO	SAKURA NO
HITACHI			HYDAC			HYUNDAI			INTERNATIONAL HARVESTER		
71	70431021	H-65030	10	0160MA005BN	HC-55290	11	31N4-01460	H-27251	8	1233914H2	HC-7603
72	70665859	H-65030	11	0160MA010BN	HC-55260	12	31N8-01360	HC-28130	9	133736C1	H-5410
73	71316231	H-62040	12	02055904	H-62070	13	31N8-01510	H-28042	10	1698964-C92	H-55420
74	73022104	H-65030	13	02060601	H-5001	14	31Q6-01280	H-28060	11	1976934C3	HC-5511
75	73104894	H-65030	14	02060610	H-55380	15	34L3-00341	H-28020	12	381256 R91	H-5405
76	73131887	HC-7972	15	02060879	H-42260	16	37HN-30070	H-5910	13	381258R92	H-5405
77	74335348	H-65030	16	02062367	H-42020	17	46321-22015	HC-69031	14	401073R2	H-5410
78	74369988	H-65030	17	0330D01OBN3HC	H-62090	18	E131-0212	H-2725	15	530144R92	H-5410
79	74371021	H-65030	18	10616D25BN	H-42260	19	E131-0212-4	H-2725	16	631144 C1	H-5406
80	74371137	H-65030	19	11108D12BN	H-5001	20	E131-0214	H-2801	17	631144 C2	H-5406
81	74587711	H-65030	20	11113D25BN	H-55380	21	E131-0214-A	H-2801	18	65126C92	H-5410
82	74853388	H-57030	21	1250149	H-55331	22	ZGAQ-00001	HC-76130	19	884879C1	H-5640
83	76040430	H-2711	22	1250490	H-62030	IHC HOUSING			INTERNORMEN		
84	76580323	H-2709	23	1251197	H-4903	1	113464-C91	HC-69030	1	01.WP.130.25P	HC-7907
85	79010563	H-65030	24	1251201	H-4902	IHI			2	01E42510VG16SP	H-62080
86	EU4051572	H-5001	25	2055752	H-62030	1	075-511902	HC-5807	3	01E42516VG16SP	H-62080
87	PM 50V00012F1	H-7990	26	2060601	H-5001	2	075910291	HC-7940	4	0200060D10VG	H-62070
88	X4114950	H-7904	27	2060610	H-55380	3	075911603	HC-5401	5	0200060D10VG30HC	H-62070
89	YA00016054	H-2724	28	2062367	H-42020	4	075911603	HC-5603	6	020030D10VG30	H-55332
90	YA00033064	H-27390	29	240D010BNHC	H-62100	5	075914201	HC-54040	7	020060D10VG30HCEP	H-62070
91	YA00033065	H-27380	30	60308D20BN	H-42020	6	075914401	HC-54050	8	020160D10VG3	H-62030
92	YD00003087	H-27370	31	H23012	H-79411	7	6115021520	H-7914	9	020160D10VG30HC	H-62030
HM			32	H573082	HC-7901	IKRON			10	020160D10VG30HCEP	H-62030
1	81004662	H-65030	33	H830016020BN	H-42260	1	HHC03577	H-85520	11	05960025VG10EP13	H-55380
HOKUETSU KOGYO			34	H960013020BN	H-55380	IN-LINE FILTERS			12	1E42510VG16SP	H-62080
1	3743-803401	HC-5802	35	H96008010BN	H-5001	1	FIN-FH50509	H-56650	13	1E4251GVG16SP	H-62080
2	37438-01500	HC-5807	36	HK020BN	H-7976	INGERSOLL RAND			14	300247	H-62080
3	37438-01900	HC-5807	37	HK020P	H-7976	1	3525214	H-6902	15	300253	H-62080
4	37438-03400	HC-5802	38	HK23012	H-79411	2	35290162	H-57030	16	300398	H-62070
5	39178-06400	HC-5807	39	HK24007	H-79411	3	35295427	H-7905	17	300848	H-62030
HOUGH			40	MFE16005BN2	HC-55290	4	35296920	HC-6901	18	301069	H-55380
1	1233914H2	HC-7603	41	MFE16010BN2	HC-55260	5	35330125	H-7905	INTERPARTS		
2	398706	HC-7972	HYDRECO			6	35989623	H-79411	1	04/110147	HC-7913
HUAKONG			1	EHP100B15B	H-5001	7	35997352	H-7905	2	990/00090	H-7922
1	HY6252	H-8543	HYDRO FLEX			8	36897346	HC-69050	3	KNJ0288	HC-8805
2	HY6450	H-8544	1	77208-22-P25	HC-7907	9	38480265	H-57030	INTRUPA		
HUBER-WARCO			HYDRO GEAR			10	39136650	HC-57030	1	51482	HC-7972
1	102229	H-79411	1	51563	HC-7947	11	39856836	HC-69050	2	83432	HC-55250
HUERLIMANN TRAKTOREN			HYDRO-CRAFT			12	4202525	HC-51020	3	IF7004	HC-57020
1	0.900.1261.4	H-45050	1	A130	H-8515	13	50343490	H-7985	4	IF7004Q	HC-57020
2	2.4419.280.0	HC-51040	HYDROFILT			14	50430024	H-65030	5	IF7008	HC-55260
3	2.4419.280.0/10	HC-51040	1	A130	H-8515	15	50469048	H-7905	IRLEMP		
HUPPENKOTHEN BAUMASCHINEN			HYMAC			16	50693886	H-57030	1	PERI-262	HC-6217
1	1551200601T	H-5513	1	2700210	H-62040	17	51302214	HC-5503	ISEKI		
HY-PRO			2	3468557	H-42020	18	52195401	HC-7905	1	1608-206-260-0	HC-18150
1	HP06DNL412MB	H-62070	3	415567	H-62040	19	52261450	H-65030	2	1614-508-262-00	HC-7915
2	HP16DNL512MB	H-62030	HYSTER			20	52263183	H-57030	3	1641-515-391-00	HC-7963
3	HP37L825MB	H-42020	1	0256226	H-57030	21	54672654	HC-6802	4	1643-515-202-10	HC-7926
4	HP60L1325MB	H-55380	2	1360557	H-5902	22	56920101	H-57030	5	1719-508-791-00	HC-79530
5	HP60L812M	H-5001	3	1392399	HC-55250	23	56945512	H-57030	6	1742-508-332-00	HC-47010
6	HP60L812MB	H-5001	4	1556992	HC-45030	24	57394728	H-69030	7	1742-508-33200A	HC-47010
7	HP75L412MB	HC-55260	5	1655472	HC-51020	25	57512931	HC-69031	8	1759-508-402-00	HC-79530
8	HP75L46MB	HC-55290	6	2021933	H-85480	26	575129311	HC-69031	9	1771-510-251-00	HC-52010
9	HP75L8149WB	HC-42090	7	2028634	H-5914	27	58036880	H-42020	10	3667-354-2400-0	HC-47020
10	HP79L1625MB	H-57030	8	256226	H-57030	28	59507368	H-65030	11	3874-354-211-0	HC-2709
11	HP83L1625MB	H-42260	9	309112	TC-7918	29	59877779	HC-57020	ISUZU		
12	HP83L1625MV	H-42260	10	398706	HC-7972	30	59888990	HC-55290	1	6630309	H-5410
13	HPMF4L810MB	H-62060	11	853531235	HC-55240	31	59945402	HC-55260	IVECO		
14	HPTX3L1910MB	H-76040	HYUNDAI			32	90536046	HC-55240	1	1901608	H-65030
HYDAC			1	31E3-0018	H-2719	33	92092220	H-65030	2	29538232E	H-8519
1	0060D010BN	H-62070	2	31E3-4529	H-28080	34	FC1093R010BS	H-8541	3	3512829	H-6301
2	0060D010BN3HC	H-62070	3	31E9-0018	H-5211	INTERNATIONAL HARVESTER			4	42491185	H-7103
3	0060D010BN4HC	H-62070	4	31E9-1019	H-28040	1	075511806	H-5401	5	596890	H-65030
4	0060D010BNHC	H-62070	5	31E9-10190	H-2801	2	075912103	HC-7901	J.C.BAMFORD		
5	01250487	H-62070	6	31E90126	HC-7940	3	1103452C2	HC-5402	1	04/800191	HC-76110
6	0160 MU 010P	HC-79520	7	31L1-4041	H-28030	4	1103462-C1	HC-5402	2	04/802409	HC-76110
7	0160D010BN	H-62030	8	31LH-60070	H-28070	5	113464-C91	HC-69030	3	32/300518	H-65030
8	0160D010BN3HC	H-62030	9	31MH-01310	H-28050	6	113465C1	HC-69030	4	32/901200	H-5103
9	0160D010BN4HC	H-62030	10	31MH-20320	H-7105	7	1140079 C1	H-5403	5	32/901701	HC-7906



Manufacturer's Cross Reference

NO	REFERENCE NO	SAKURA NO	NO	REFERENCE NO	SAKURA NO	NO	REFERENCE NO	SAKURA NO	NO	REFERENCE NO	SAKURA NO
J.C.BAMFORD			JOHN DEERE			KENTEK			KOBELCO		
6	32/909200	HC-5508	32	F058437	H-7602	1	HK25103	H-28030	40	YN52V01011P1	H-4101
7	32/917701	H-5107	33	FO58437	H-7602	2	HK25107	H-28070	41	YN52V01011P1	H-41013
8	32/922500	HC-55190	34	LVA16054	HC-76150	3	HK25142	H-2724	42	YN52V01011P1	H-7923
9	32100211	H-42020	35	RE27284	HC-76120	4	HK25354	H-28040	43	YN52V01011P1	H-85231
10	32905501	HC-76080	36	RE34958	HC-5508	5	HK25358	H-27251	44	YN52V01011P1	H-85232
11	32925195	H-62030	37	RE39527	HC-5504	6	HK25377	H-2719	45	YN52V01011P2	H-8523
12	32925197	HC-76130	38	RE45864	HC-7602	7	HK25378	H-7105	46	YN52V01011P2	H-85231
13	32925905	HC-76130	39	RE521420	HC-76140	8	HK25480	H-7911	47	YN52V01011P2	H-85232
14	32925905A	HC-76130	40	T175002	HC-55090	9	HK25495	H-2703	48	YN52V01011P2	H-85235
15	4110147	HC-7913	41	TH110133	H-2706	10	HK33241	HC-8501	49	YN52V01013P1	H-8523
16	4802409	HC-76110	42	TT220735	H-76040	11	HK39391	H-2801	50	YN52V01013P1	H-85231
17	500005302	HC-7940	JOY			12	HK39791	H-28020	51	YN52V01013P1	H-85232
18	50005302	HC-7940	1	01228337-0020	HC-7925	13	HK39960	H-28042	52	YN52V01013P1	H-85235
19	581/00012	H-51050	2	100028583	HC-55260	14	HS25090	H-7969	53	YN52V01016R100	H-4101
20	581/01801	H-8401	3	5276313	H-65030	15	LS33115	HC-7906	54	YN52V01016R100	H-41013
21	581/18063	HC-8501	4	5276319	H-65030	16	LS33129	HC-7907	55	YN52V01016R100	H-7923
22	58105601	H-7973	5	5419960381	H-55380	17	LS33216	HC-6801	56	YN52V01016R600	H-41013
23	58106301	H-7973	6	5419960396	H-42020	18	LS33219	HC-6802	57	YN57V000025010H	H-8516
24	69/000051	H-5001	7	7017010321	H-57030	19	LS33221	HC-5502	58	YR50V00004P1	H-41080
25	6900/0084	H-5107	8	701701251	H-79411	20	LS33223	HC-7964	59	YR50V00006F2P	H-7970
26	99000090	H-7922	JURA FILTRATION			21	LS33227	HC-2701	60	YR50V00006F1	H-7919
27	JSJ 0075	H-43010	1	SA53014	H-62040	22	LS33264	HC-6803	61	YV52V01003R110	H-85231
28	KBJ1691	H-2719	2	SA56231	H-62040	23	LS33384	HC-7940	62	YV52V01003R110	H-85232
29	KRJ 1599	H-5519	3	SH 60084	HC-7914	KERSHAW			63	YV52V01003R110	H-85235
J.L.G INDUSTRIES			4	SH52081	H-62110	1	651429	HC-7972	64	ZD12G19000	H-41030
1	1736340	H-85521	5	SH53014	H-62040	KHD(KLOCKNER-HUMBOLT-DEUTZ)			KOEHRING BOMAG		
2	2120129	HC-55290	6	SH56168	H-65030	1	0.900.1261.4	H-45050	1	31005666	H-57030
3	2120149	HC-55260	7	SH56231	H-62040	KNECHT			2	8535301235	HC-55240
4	7041588	HC-55260	8	SH56232	H-85110	1	AF46	H-79411	3	853531235	HC-55240
5	7041596	HC-55260	9	SH56340	H-57030	KOBELCO			4	853531241	H-57030
6	8008101	HC-45030	10	SH56344	H-57030	1	24046Z12	H-5515	KOMATSU		
JACOBSEN TEXTRON			11	SH56400	HC-51040	2	24046Z15	H-7919	1	07063-01035	H-5625
1	4121553	HC-55260	12	SH56613	HC-7972	3	24046Z18	H-7911	2	07063-01054	H-5607
JENBACHER			13	SH56623	HC-55240	4	2446R116E1	H-5208	3	07063-01100	H-5610
1	224 404	HC-7964	14	SH56756	HC-55260	5	2446R307S1	H-5803	4	07063-01142	H-5609
JINMA			15	SH57125	H-55380	6	2446R330F1	H-7969	5	07063-01210	H-7911
1	JX0811A	HC-79500	16	SH66065	H-57030	7	2446R336F1	H-7986	6	07063-01383	H-2709
JOHN DEERE			17	SH66109	HC-5516	8	2446R336F1P	H-7986	7	07063-01412	H-5609
1	841334500	H-85110	18	SH66324	HC-7972	9	2446U126	H-7934	8	07063-11046	H-5637
2	841334500J	H-85110	19	SH66335	HC-57030	10	2446U141S2	HC-7901	9	07063-51100	H-56600
3	AE29824	H-79411	20	SH66542	HC-57020	11	2446U2335-2	H-4102	10	07063-51210	H-56550
4	AH61470	H-65030	21	SH66705	HC-55250	12	3008679	H-5614	11	07063-51383	H-5649
5	AL118036	HC-5504	22	SPH9476	HC-51040	13	3008679	H-5615	12	101-60-15170	H-5611
6	AL77061	HC-76080	K-FLO			14	FZ1F180K001A	H-8523	13	101-60-15171	H-5611
7	AM102723	HC-76100	1	KH320	H-7963	15	FZ1F180K001A	H-85231	14	113-60-23160	HC-5601
8	AR20554	H-65030	KAELBLE			16	FZ1F180K001A	H-85232	15	113-60-33130	HC-5602
9	AR75603	H-7601	1	06501361	H-6301	17	FZ1F180K001A	H-85235	16	113-60-43320	HC-5602
10	AR94510	H-76060	KALMAR			18	H 401	H-7912	17	113-60-43321	HC-5602
11	AR98098	H-76070	1	4258178279	HC-45030	19	H 403	H-2705	18	1233914H2	HC-7603
12	AT 182209	HC-76090	2	74853388	H-57030	20	H 404	H-2701	19	124-15-51740	H-5638
13	AT-308274	HC-76070	3	9210280007	HC-45030	21	H 405	H-2704	20	125-15-11721	H-5638
14	AT103193	HC-7601	4	9223150002	H-76040	22	H 409	H-2702	21	125-15-11722	H-5638
15	AT103193	HC-7606	5	9225920078	H-42020	23	H-141	H-7979	22	1281327H1	HC-5508
16	AT112393	HC-5506	6	9231100078	H-42020	24	H-143	H-7980	23	130-60-48210	H-5608
17	AT120444	HC-7929	KALMAR LMV			25	H142	H-7920	24	131570H1	H-65030
18	AT120444	HC-7939	1	9234360919	HC-7919	26	K907	H-5803	25	141-60-18270	H-5610
19	AT140315	HC-7604	KATO			27	K909	H-5803	26	144-49-13853	H-5641
20	AT179323	HC-76110	1	689-3570302-1	HC-1014	28	PH50V00005F1	H-7986	27	144-60-11160	H-5601
21	AT184206	HC-7603	2	689-3570303-2	HC-1014	29	PM50V00012F1	H-7990	28	14X-60-31150	H-56650
22	AT222005	HC-76130	3	689-37001001	H-7914	30	PR50V00002P1	H-5634	29	154-19-12130	H-5504
23	AT274339	HC-62020	4	689-37310012	H-1015	31	PW52V01001R100	H-41060	30	154-19-12130	H-5602
24	AT336140	HC-76130	5	689-5703031	HC-5807	32	PW52V01002P1	H-41060	31	154-60-12170	H-5607
25	AT49249	H-5109	KAWASAKI			33	R36N0007	H-4102	32	175-43-14130	H-5621
26	AT58368	HC-7938	1	3098120060	H-7911	34	R36P0019	H-5211	33	175-49-11222	H-7910
27	AW-16050	H-79411	KAYDON			35	R36P002	H-4102	34	175-49-11580	H-5606
28	AZ36942	HC-5502	1	KS4009-25	H-7976	36	SK300	H-7984	35	175-60-27380	H-5610
29	AZ64238	H-56580	KDCPARTS			37	YN 50V01001S005	H-5643	36	178-611-4160	H-5505
30	E35481	H-65030	1	1281327H1	HC-5508	38	YN50V00001P1	H-2728	37	195-13-13420	H-56570
31	F023753	HC-57020	KENTEK			39	YN52-V0101 1P1	H-41012	38	195-60-16320	H-5609



Manufacturer's Cross Reference

NO	REFERENCE NO	SAKURA NO	NO	REFERENCE NO	SAKURA NO	NO	REFERENCE NO	SAKURA NO	NO	REFERENCE NO	SAKURA NO
KOMATSU			KOMATSU			KUBOTA			LETOURNEAU-WESTINGHOUSE		
39	198-49-11440	H-5622	108	65126C92	H-5410	29	HH950-82620	HC-8811	7	VS-0654	H-79411
40	2-3EB-66-21140	H-5606	109	693688	HC-7972	30	HHK20-36990	HC-18050	LEYLAND-DAF		
41	201-60-22150	H-5909	110	6964737	H-62110	31	HHK70-14070	HC-88210	1	ABU8545	H-65030
42	201-60-65210	H-7959	111	703-301-210	H-7911	32	HHK71-14080	HC-18051	LHA		
43	203-60-21141	H-5630	112	706-30-1383	H-2709	33	HHTA0-37710	HC-5816	1	LHE623BTA25SB	H-55380
44	203-60-31150	H-5631	113	7063-01-383	H-2709	34	HHTA0-59900	HC-88020	2	SPE503	HC-55290
45	204-60-21470	H-56610	114	7063-51-210	H-85680	35	K2561-36990	HC-18050	3	SPE62-25	HC-7907
46	205-60-51430	H-7911	115	714-07-14522	H-56660	36	K7561-1407	HC-88210	4	TIE12P252	H-85521
47	205-60-51450	H-5613	116	79360	HC-69030	37	K7561-14070	HC-88210	5	TIE16252	H-85521
48	207-60-71180	H-5629	117	8257-107	H-7901	38	K7561-1408	HC-18051	6	TIE16P252	H-85521
49	207-60-71180	H-5646	118	BW252116	HC-2701	39	R1411-64930	H-2719	7	TIE25-25-1	H-7976
50	207-60-71181	H-5629	119	CA0040952	HC-45050	40	RA011-62190	H-8902	8	TIE25-25-P	H-7976
51	207-970-5121	H-5636	120	CA0045177	HC-45050	41	RB411-62190	H-88040	LIEBHERR		
52	208-60-61150	H-2709	121	CA0139413	HC-7965	42	RC461-62150	H-88090	1	006 152 03 P	H-62010
53	208-60-71121	H-5639	122	F25701500	H-2727	43	RD 401-62150	H-4905	2	063 102 050 F	H-62020
54	208-60-71122	H-5639	123	SP6292	H-65030	44	RD411-62210	H-88050	3	063 152 030 F	H-62010
55	208-60-71122A	H-5639	124	TL6209	H-65030	45	RD431-62120	H-88030	4	064 102 052 F	H-62020
56	208-60-71123	H-5639	125	VZ2854	H-65030	46	RD431-62122	H-88080	5	065 152 030 F	H-62010
57	209-60-12840	H-5623	126	ZZ0706301054	H-5607	47	RD451-62120	H-88060	6	065 152 030 FL	H-62010
58	209-60-51120	H-56710	KOX			48	RD809-62240	HC-54040	7	10037616	H-62070
59	209-60-77532	H-56590	1	FH042	H-8515	49	RD809-62241	HC-54040	8	104 70100	H-62110
60	209-607-6210	HC-5602	KRALINATOR			50	T0070-37711	HC-5816	9	311152	H-8515
61	20Y-60-21470	H-56610	1	KL930	H-65030	51	T0070-37711	HC-5817	10	5106143	H-85520
62	20Y-60-31140	H-56620	2	L-814	H-7976	52	TA040-37710	HC-5816	11	510614308	H-85520
63	20Y-62-51691	H-7105	3	L-855A	H-79411	53	W21TSH3300	HC-5817	12	5106173	H-8515
64	21N-60-12210	HC-5603	4	L1731	HC-5506	54	W21TSH3A00	HC-8811	13	510617308	H-8515
65	21T-60-31450	HC-56080	5	L255	HC-55250	55	W21TSH3A10	HC-88111	14	510617314	H-8515
66	21W-60-41121	H-56540	6	L348	HC-7604	56	W21TSH5200	HC-5801	15	5106528	H-62030
67	22B-60-11160	H-5635	7	L420	H-57030	57	W21TSH6600	HC-52020	16	5106608	H-62030
68	22L-60-22120	H-56530	8	L434	H-57030	58	W21TSH6700	HC-88010	17	510669208	H-62060
69	281-16-11290	H-5620	9	L451	HC-57020	59	W21TSHK200	HC-18050	18	510669708	H-62050
70	285-62-17320	H-5652	10	L454	HC-57030	60	W21TSHK700	HC-88210	19	512600408	HC-76130
71	285-62-17320A	H-5652	11	L486	HC-55240	61	W21TSHK710	HC-18051	20	5603559	H-55380
72	287-16-11510	H-5620	12	L497	HC-57030	62	W21TSHA10	HC-5816	21	5612546	HC-62020
73	3002574R91	H-65030	KS			63	W21TSHA20	HC-88020	22	5705816	H-62070
74	3071235R91	H-65030	1	H-193	H-5526	64	W9501-15001	HC-88010	23	570584808	H-55331
75	311781-31140	H-5625	2	H114N	H-4102	65	W9505-51091	H-88090	24	7004209	HC-62020
76	319926R91	H-65030	3	H207-3	HC-5807	66	W9505-55051	H-88070	25	7010930	HC-7907
77	346271-31110	H-7929	4	KS-H411	H-7940	67	W9505-55061	H-88050	26	721 1198	H-62010
78	34B-66-15180	H-7946	5	KS207-3	HC-58073	KUKJE			27	721 1220	HC-6801
79	361-60-11120	HC-5807	KUBOTA			1	TA00016986A	HC-79550	28	736 0470	H-62020
80	361-60-11121	HC-58090	1	172179-73720	HC-5801	L & T CASE			29	736 4368	H-62110
81	373-952-178	H-6301	2	32701-37950	HC-88060	1	T20350509	H-85110	30	7362910	H-55330
82	3EA-15-11600	H-5624	3	32701-37951	HC-8804	LAMBORGHINI			31	7368875	H-62120
83	3EA-66-33560	H-5633	4	33960-82630	HC-5816	1	0.900.1261.4	H-45050	32	7373884	H-62120
84	3EB-66-11711	H-5632	5	33960-82631	HC-5816	2	2.4419.280.0	HC-51040	LINDE		
85	3EB6-61-1710	H-5632	6	33960-82632	HC-5816	LANCER BOSS			1	000 983 0623	HC-6803
86	3EB6-61-1711	H-5632	7	34150-37710	H-88020	1	8748874	HC-76110	2	000 983 1644	H-85880
87	3EB6-61-1711L	H-5632	8	35861-82630	HC-7931	LANSING-LINDE			3	000.983.06.01	HC-6803
88	3EB7-61-1710	H-5632	9	36330-82630	HC-7932	1	6604900-001	H-79411	4	0009830623V	HC-6803
89	3EB7-61-1711	H-5632	10	38430-3771-4	HC-7975	LBX COMPANY LLC			5	9830623	HC-6803
90	3ED-66-11330	HC-7901	11	3A431-82623	HC-8811	1	940011	H-42020	6	9830623V	HC-6803
91	3ED-66-42111	H-56630	12	3A431-82632	HC-8811	2	KHJ 1493	H-5513	LINDNER		
92	418-18-34160	HC-56060	13	67955-37710	HC-88010	LEE ENGINEERING			1	292760	HC-85210
93	419-15-16930	H-56640	14	68051-62220	HC-52010	1	LP7S	H-65030	2	735700733011	HC-85210
94	419-60-15250	H-56720	15	68131-6213-0	HC-5807	LEE MIN			LINKBELT		
95	421-43-HOP43	H-56700	16	68131-6213-0	HC-58073	1	TLX235L	H-42190	1	E1A0080	HC-55250
96	424-16-11140	H-5618	17	68131-6213-2	HC-5807	2	TLX368C	H-42240	2	KBJ1691	H-2719
97	42Y-60-H5080	H-56560	18	68651-62120	H-7956	LEOSING			3	KRJ 1599	H-5519
98	42Y15H0V35	HC-76130	19	68773-62210	H-88070	1	140131	HC-7966	4	KRJ3836	H-2727
99	42Y15H0V35	HC-76130	20	68773-62230	HC-5602	LEROI			LOED		
100	562-15-11570	H-56680	21	69284-62210	H-88100	1	438451	H-57030	1	202212	H-57030
101	562-15-11570	H-56740	22	69481-62210	H-4903	LETOURNEAU-WESTINGHOUSE			LOESING		
102	569-16-81160A	H-5651	23	HH330-82630	HC-5817	1	4068356	H-57030	1	020038	HC-55250
103	569-43-83920	H-56580	24	HH3A0-82630	HC-88111	2	KC6086	H-65030	2	020107	HC-55240
104	581-91-19120	H-56670	25	HH3Y0-82590	HC-88030	3	PB5038	H-65030	3	020815	HC-57020
105	58673-15100	H-7902	26	HH3Y0-82591	HC-88030	4	SF6298	H-65030	4	021826	H-55380
106	600-319-81161	H-7929	27	HH520-15320	HC-5801	5	SP6292	H-65030	5	021977	HC-7972
107	613797C91	H-65030	28	HH670-37710	HC-88010	6	SU6848	H-65030	6	022001	HC-7972



Manufacturer's Cross Reference

NO	REFERENCE NO	SAKURA NO	NO	REFERENCE NO	SAKURA NO	NO	REFERENCE NO	SAKURA NO	NO	REFERENCE NO	SAKURA NO
LOESING			LUBER-FINER			MANITOU			MANN & HUMMEL		
7	140035	H-85521	53	LP214	H-5410	8	236095	H-51140	51	WH1257/2	HC-7001
8	140061	H-62050	54	LP560	H-5503	9	513752	H-51190	52	WH722	HC-5505
9	140081	H-62050	55	LP560	H-5526	10	545438	H-85110	53	XHD1-8238	H-7986
10	140097	HC-55180	56	LP6005	HC-7901	11	550145	HC-51020	54	XWD1-8204	HC-7913
11	140522	HC-45030	57	LP816	H-5502	12	563483	H-51160	MARINE		
12	20107	HC-55240	58	SPH94046	HC-54040	13	602096	H-51130	1	1004512	H-57030
13	20767	H-57030	LUGLI CARRELLI ELEVATOR			14	673203	HC-7906	2	1906209	HC-57020
14	20815	HC-57020	1	R2754380	H-85521	15	686236	H-51120	MARION		
15	20837	HC-55260	LULL			16	737524	H-7602	1	948983	H-79411
16	21718	H-57030	1	10867527	HC-55180	17	744789	H-8546	MASSEY-FERGUSON		
17	21826	H-55380	2	71200641	HC-7972	18	745878	HC-51030	1	1022883M1	H-79411
LONKING			3	P200641	HC-7972	19	77402	H-51200	2	1023057M1	H-5109
1	LG50F-100012-H	H-42150	M FILTER			20	820437	H-51180	3	1033356M1	HC-1903
LOSENHAUSEN			1	MO1128P	H-79411	21	899154	H-51230	4	104309W91	HC-7933
1	04022/19303	HC-6801	2	MO1103	H-79411	22	949530	HC-57041	5	1087412M91	H-65030
2	04991/44274	HC-5502	3	MO1128P	H-79411	MANITOWOC			6	1495479M1	H-5517
LUBER-FINER			M.D.F. SARL			1	1004512	H-57030	7	1662-566M1	H-7906
1	1623186	HC-19060	1	MDH4694	H-62030	2	4270670	HC-57020	8	1870199M92	H-5102
2	1718623	H-53010	2	MDH6033	HC-57020	MANN & HUMMEL			9	191855M4	H-71190
3	37104	HC-5503	MACDON			1	CS51	H-56610	10	2754362M1	HC-62020
4	49076	HC-5503	1	202986	HC-55260	2	FP7565	HC-55250	11	2894080-M1	H-6301
5	LFH-4223	HC-6501	MACK			3	H 1095	H-62020	12	2979653M1	HC-6802
6	LFH-4223	HC-6502	1	485GB3160	H-71160	4	H 1497/2	H-5503	13	303506819	HC-5508
7	LFH1832	HC-55250	MAHINDRA			5	H 15 263	H-62010	14	3383386-M92	HC-51070
8	LFH1922	HC-55250	1	5556039R91	HC-7919	6	H 623	H-71180	15	3386701M1	HC-51060
9	LFH22150	HC-55180	MAHLE			7	H 710/1 N	H-7103	16	3386701M2	HC-51060
10	LFH4211	H-5611	1	852125SMX10	H-7105	8	H 710/1 X	H-7102	17	3386701M3	HC-51060
11	LFH4212	H-5620	2	HC 113	HC-7920	9	H 710/1 Z	H-7104	18	3530223M92	H-5101
12	LFH4213	H-5606	3	HC10	HC-76110	10	H 824/2	H-85520	19	35630223M92	H-5101
13	LFH4268	HC-7906	4	HC34	HC-5502	11	H111061	H-65030	20	3581032M2	HC-7908
14	LFH4471	HC-57020	5	HC41	HC-5502	12	H12105	H-65030	21	3581032M2	HC-79081
15	LFH4635	H-5509	6	HX17	H-5408	13	H12105N	H-65030	22	3595175M1	HC-5101
16	LFH4935	HC-7935	7	HX40	H-7102	14	H1290/1	H-6301	23	3618662M1	H-5001
17	LFH4936	HC-7927	8	HX6	H-6301	15	H1375	H-62040	24	3618662M2	H-5001
18	LFH4936	HC-7972	9	KFO0232022	H-65030	16	HD 11 001	H-56650	25	3902287M1	H-7975
19	LFH4950	HC-7972	10	KFO0232222	H-65030	17	HD 1164/1	H-5618	26	516069-M94	H-51170
20	LFH5015	HC-7602	11	KFO0232672	H-65030	18	HD 15 174	H-7911	27	577492M91	H-79411
21	LFH5068-10	HC-5511	12	KFO0232674	H-65030	19	HD 16 190 X	H-7981	28	MF185	H-5102
22	LFH5074G	HC-45050	13	OC 122	HC-5502	20	HD 4001 X	H-2712	MATBRO		
23	LFH5074G0001633389	HC-45050	14	OC 147	HC-45160	21	HD 45	H-55330	1	CL230962	H-5109
24	LFH5075	HC-55200	15	OC 484	HC-5502	22	HD 55	H-71190	MAZZOTTI		
25	LFH5659	HC-5506	16	OC 70	HC-45150	23	HD 622/1	H-85880	1	210110700	H-85521
26	LFH8197	HC-19060	17	OC268	HC-85210	24	HD 722/1	H-45050	MC CORMICK (LANDINI-ARGO)		
27	LFH8229	HC-7604	MAIN FILTER			25	HD 846	H-5001	1	104929	H-57030
28	LFH8454	HC-5505	1	A150G06	HC-55290	26	ML1008	H-5406	2	105892	H-57030
29	LFH8534	HC-7905	2	A150G10	HC-55260	27	W 1150/2	HC-45110	3	116428	H-57030
30	LFH8740G	HC-55260	3	A421G03V	HC-55270	28	W 1237/1 X	HC-5511	4	220272	HC-7905
31	LFH8740G0001627940	HC-55260	4	CCH803FV1	H-55380	29	W 1254/2 X	HC-7602	5	294721A1	HC-76080
32	LFH9353	HC-55280	5	D931G25A	H-42020	30	W 1387	HC-51060	6	3139076R92	H-5407
33	LFP449	HC-5511	6	DHD160G10B	H-62030	31	W 8010	HC-18051	7	3224623R1	H-5408
34	LFP5015G	HC-55290	7	DHD160G20V	H-62030	32	W 923/7	HC-45160	8	3556455M1	H-2726
35	LFP8297	HC-7973	8	DHD60G10	H-62070	33	W 935/2	HC-5801	9	4204121M1	HC-7974
36	LH 22142	H-51050	9	R122C25B	H-85521	34	W 945	HC-1902	10	703884A1	H-7975
37	LH4231	H-55380	10	R164G10B	H-62050	35	W1269	HC-7907	11	D120594	HC-7972
38	LH4465	H-57030	11	R732C10	H-76050	36	W92614	HC-6217	12	L031230	H-65030
39	LH4994	H-57030	12	R732C25	H-76050	37	W930/14	HC-7920	13	MC113465C1	HC-69030
40	LH5001	H-57030	MAN			38	WD 10 001 X	HC-8811	14	MC133736C1	H-5410
41	LH5018	H-53010	1	51.05504-0066	HC-5502	39	WD 11 002	HC-51040	15	MC1966553C1	HC-7907
42	LH5461	H-5506	2	51.05504-0067	HC-5502	40	WD 13145	HC-5502	16	MCT40153	H-79411
43	LH5840	H-7973	3	81.06668.0006	H-85520	41	WD 724/6	HC-6803	MECALAC/PELJOP		
44	LH8414G	H-71130	4	81.33215.0002	H-7104	42	WD 950/2	HC-62020	1	1551100200	H-7986
45	LH8520	H-62020	MANITOU			43	WD724/3	HC-6803	2	E6050042	H-85560
46	LH8523	H-62010	1	109565	H-85550	44	WD940/4	HC-76110	3	E6050119	HC-55190
47	LH8544	H-7911	2	15511-02103	H-8547	45	WD950	HC-6801	4	E605A0006	HC-62060
48	LH8640	H-7102	3	15512-00703	H-2712	46	WD962	HC-6802	MENGELE (CNH GLOBAL/MENGELE)		
49	LH95037V	H-42260	4	21967	H-51220	47	WH 12573	HC-55280	1	72276664	H-7986
50	LP-2854	H-7976	5	221174	H-51220	48	WH 7001	HC-55300	MERCEDES-BENZ		
51	LP151	H-65030	6	224726	H-51210	49	WH 9451	HC-57020	1	00 270 28 98	H-7102
52	LP164	H-5504	7	236094	H-51150	50	WH1257/1	HC-5512	2	000 270 10 98	H-7102



Manufacturer's Cross Reference

NO	REFERENCE NO	SAKURA NO	NO	REFERENCE NO	SAKURA NO	NO	REFERENCE NO	SAKURA NO	NO	REFERENCE NO	SAKURA NO
MERCEDES-BENZ			MORBARK			NAPA			NEW HOLLAND (CNH)		
3	000 271 01 56	H-7102	1	26638671	HC-55240	16	1519	HC-7919	29	84409205	H-45050
4	000 466 29 04	H-71180	2	26746148	HC-57020	17	1524	H-5609	30	84581942	HC-45140
5	15H624	H-7941	3	26746169	HC-55240	18	1527	H-57030	31	85802793	HC-7001
MICHIGAN			4	26838085	HC-7933	19	1535	H-57030	32	859086	HC-7972
1	201026	HC-79500	5	26838671	HC-55240	20	1543	H-57030	33	859343	HC-7972
2	2366807	HC-7941	6	26838672	HC-7972	21	1544	H-57030	34	86513279	H-5001
3	243622	HC-5503	7	26868671	HC-55240	22	1567	H-79411	35	86597482	HC-5516
4	4148393	H-79411	MOTORCRAFT			23	1632	HC-55260	36	87022001	HC-7972
5	6505024	H-79411	1	EFL212	H-65030	24	1733	HC-55250	37	89821387	HC-5504
6	6505034	H-79411	2	FH-12	H-79411	25	1818	HC-6217	38	920019190	HC-5507
7	6516722	HC-1903	3	FH-25	H-7976	26	1861	HC-19060	39	9821387	HC-76080
8	6598903	HC-7927	4	FH46	H-65030	27	557201	HC-76110	40	E7NN6714FA	HC-7901
9	6599543	HC-7923	5	FL29	H-65030	28	7115	HC-5516	41	E8NNF882BA	H-5001
10	896154	H-79411	6	FL326	HC-5502	29	7201	HC-76110	42	K51333203	H-45030
11	946865	H-79411	7	FL40	H-65030	30	7220	HC-45050	43	KNJ2567	H-7986
12	948983	H-79411	MOXY			31	7407	H-53010	44	MT40007563	HC-45100
13	965899	HC-55250	1	370L210A	H-42020	32	7418	HC-55280	45	ND065484	H-45050
MIJACK			MP FILTRI			33	7608	HC-42090	46	PU50V00001P2	H-45040
1	BR2404342	HC-57030	1	6.100.0331	HC-6217	34	A20A03GV	HC-55270	47	V63297	H-57030
2	BR4044471	HC-57030	2	6010047	H-55380	35	D37B20GV	H-62030	48	YN52V01021P1	H-85235
MINNPAR			3	CS-150-P25	HC-7907	36	D82E10GV	H-62070	NISSAN DONALDSON		
1	H0050262	H-57030	4	CS150P25A	HC-7907	37	R18D25C	H-76050	1	P845444	H-59210
MISFAT			5	CSG100A10A	HC-55260	NAVISTAR			NISSAN		
1	12544701	H-65030	6	CSG150M125A	HC-42090	1	117900	H-65030	1	58396-47601	HC-1822
MITSUBISHI			7	CSG50P10A	HC-19040	2	303122R91	H-65030	NISSAN KIZAI		
1	34550-33102	HC-5815	8	F10P20A	H-85521	3	304753C91	H-65030	1	562-03420	HC-5807
2	35C40-11100	HC-5601	9	HP0372A25A	H-42110	4	319926R1	H-65030	NORGO PRODUCTS		
3	37438-02300	HC-5810	10	HP0372A25AN	H-42110	5	333719R91	H-65030	1	HF3110B	H-5001
4	37438-03300	HC-5804	11	MF-100-1-A-P25-NB	H-85860	6	340175R91	H-65030	2	HF3110N	H-5001
5	37438-05601	HC-5804	12	MF4003A10HB	H-62050	7	612724C91	H-65030	NORMAT		
6	375401-0000	HC-5810	13	MP10507	H-42020	8	613797C91	H-65030	1	121706	H-51220
7	375402-0000	HC-5803	14	MP4112	H-55380	9	613798C91	H-65030	O & K ORENSTEIN & KOPPEL		
8	385-10100021	H-5618	15	MP9206	H-62070	10	73133001	HC-42090	1	140632	H-55380
9	385-10100022	H-5618	16	MP9407	H-62030	11	877380C91	H-65030	2	1447314	H-85110
10	4654430	H-7938	17	MR6301A10A	H-62040	NELSON			3	1448900	H-57030
11	689-37001001	H-7914	18	MR6301A25A	H-62040	1	83520A	H-79411	4	1448990	H-57030
12	689-38210010	H-7914	19	MR6301P10A	H-62040	2	87904F	H-55420	5	4194770	H-65030
13	689-38210011	H-7914	20	MR6302P10A	H-85110	3	87904M	H-55420	6	4787500	H-65030
14	91004-10021	HC-5807	21	MR6304A10A	H-76040	NEOPART			7	5620129	H-85521
15	91276-12600	H-7950	MP PRODUCTS			1	NEOHF6389	H-53010	8	8004936	H-65030
16	91375-03800	H-5802	1	61000331	HC-6217	NEW HOLLAND (CNH)			OMNIQUIP PARTS		
17	91375-13600	H-7965	2	CS-150-P25A	HC-7907	1	1498554	H-45050	1	1319726	HC-76110
18	91375-23600	H-58040	MPSPAFILTER			2	163076	H-79411	OMT		
19	92576-14100	H-5628	1	MR1002P10A	H-8515	3	1909130	HC-45110	1	CHP627F25XN	H-55380
20	C 45702411	HC-5801	2	MR1002P25A	H-8515	4	47108105	H-45050	2	CS015MIC25	HC-7907
21	C 45702411	HC-58012	MTU			5	47131197	HC-45020	3	CS15BN	HC-7907
22	LPF 010	HC-5807	1	003 184 42 01	HC-7964	6	47427174	HC-45040	ORENSTEIN & KOPPEL		
23	LPF 08	HC-5806	2	003 184 53 01	HC-7964	7	47635916	HC-60010	1	1499401	HC-76110
24	ME536371	H-10020-S	MULTY PART			8	47671640	HC-45060	2	149940100	HC-76110
25	MS 180/3	H-5206	1	FBU8975	H-53010	9	51036002	H-57030	3	1499417	HC-6217
26	MS 180/8	H-2706	NACCO MATERIALS			10	51036006	H-57030	4	1499571	H-62040
27	MS110	H-5206	1	1392399	HC-55250	11	51333203	H-45030	5	243149	H-6301
28	MS180	H-5206	2	256226	H-57030	12	5137274	HC-62020	6	4134365	H-76050
29	PE-2200	H-1001	NAPA			13	5174044	HC-45070	7	7384996	HC-55250
30	SV-90	H-5514	1	1176	H-65030	14	5358500015	H-45050	8	8102636	H-76050
31	WP110	HC-5801	2	1203	HC-7925	15	72111326	H-48320	9	8462921	H-62040
MODINA			3	1426	H-65030	16	72189360	H-45050	OWATONNA		
1	CA302CV1	HC-7907	4	1434	H-7976	17	74853388	H-57030	1	17028719	H-79411
MOFFET			5	1439	H-57030	18	78511592	HC-7972	2	425-32521	H-79411
1	260406	H-85521	6	1447	HC-57020	19	81863799	HC-5504	P & H CO.		
MONBOW			7	1449	HC-57030	20	81865736	HC-1905	1	1046Z188	H-65030
1	MB-PX660	HC-28130	8	1451	HC-57020	21	82003166	HC-76080	2	GH5840396	H-57030
MOOG			9	1454	HC-57030	22	82005016	HC-1905	P.B.R.		
1	07106175	HC-55290	10	1457	HC-55220	23	82983474	HC-45040	1	AC-3097	H-79411
2	07160331	H-71190	11	1482	HC-7972	24	83912256	HC-1902	2	AC-3097-10	H-79411
3	7106175	HC-55290	12	1483	HC-7927	25	84074777	HC-5508	3	AC-3233	H-6301
4	7160331	H-71190	13	1485	HC-7972	26	84123428	HC-45070	4	AC3017	H-65030
5	7168896	H-5001	14	1486	HC-55240	27	84123428H	HC-45070	5	AC3202	H-62040
MORBARK			15	1510	H-57030	28	84123428H	HC-45070	P.M. GROUP		



Manufacturer's Cross Reference

NO	REFERENCE NO	SAKURA NO	NO	REFERENCE NO	SAKURA NO	NO	REFERENCE NO	SAKURA NO	NO	REFERENCE NO	SAKURA NO
P.M. GROUP			PARKER			PUROLATOR			RUSTON BUCYRUS		
1	149037	H-85521	20	GO1872	H-42020	2	F25-25N-M	H-7976	1	46151425	H-57030
PACCAR			21	MPL1212T	H-65010	3	H16041	H-71160	2	Z150297L	HC-55260
1	Y06113002	HC-45050	22	PR3058	H-62070	4	H30216	HC-7935	RYCO		
PALATEK INCORPORATED			23	PR3058Q	H-62070	5	H35028	HC-57020	1	R-2329	H-7976
1	019005200036	HC-55250	24	PR3116	H-62030	6	H40029	HC-5511	2	R-2329P	H-7976
PALFINGER			25	PR3116Q	H-62030	7	H40224	H-79411	3	R14	HC-8001
1	EA079	H-85521	26	PR3371	H-42020	8	H50042	H-5508	4	R2221P	EH-5503
2	EZ1635	H-85521	27	PR3388	H-42020	9	H50078	H-65030	5	R2267P	H-7941
3	PF15804	H-8515	28	PR3442	H-55380	10	H55032	H-76070	6	R2312	H-65030
PALL			29	PR3959	HC-55290	11	H55117	HC-55250	7	R2312P	H-65030
1	HC-7400SDT8H	HC-7939	30	PR3960	HC-55260	12	H55130	H-5001	8	R2328P	H-65030
2	HC-9600FUP13	H-7917	31	PR4389	H-8515	13	H55312	HC-7973	9	Z136	HC-7932
3	HC-9600FUP4H	H-7915	32	PR4465	H-6301	14	H56059	HC-7972	10	Z376	HC-7906
4	HC-9600FUP8H	H-7916	PAYHAULER			15	H56114	H-7976	RYCO		
5	HC2206FKS3H	H-62070	1	613798C91	H-65030	16	H56115	H-7976	1	8C3045	HC-57020
6	HC2216FKS4H	H-62030	PERLINI			17	H65176	HC-7604	2	8T7478	HC-57020
7	HC7400SUP4H	HC-69031	1	800142D	H-65030	18	H65222Q	H-85110	SAAB-SCANIA		
8	HC7400SUT4H	HC-7925	PERMATIC			19	L60069	HC-5502	1	1301696	HC-7910
9	HC7500SDK4H	HC-55260	1	LI256	H-65030	20	PEL-266	H-79411	2	1301696	HC-7920
10	HC7500SDK4HSYN	HC-55260	PERRY			21	PER-282H	HC-19060	3	1329876	H-8301
11	HC7500SDN4H	HC-55290	1	PL-286	H-79411	22	PER-303-H	HC-76110	4	1381235	H-8301
12	HC7500SDS4H	HC-55260	PETTIBONE-MULLIKEN			23	PM-5013	H-6301	SAKAI		
13	HC7500SKK4H	HC-55260	1	2115-P	H-79411	24	PM-6014-25	H-7976	1	4201-02000-0	H-7998
14	HC7500SKK4HSYN	HC-55260	2	68076	H-57030	QUINCY			2	4207-7900-00	H-85800
15	HC7500SKN4H	HC-55290	3	68076000	H-57030	1	142136	HC-8502	SAME,HURLIMANN,LAMBORGHINI		
16	HC7500SKS4H	HC-55260	4	LL716088	HC-45050	RACOR/PARKER			1	0.900.1261.4	H-45050
17	HC7500SKS4HSYN	HC-55260	PMITALY			1	1181600033	H-8541	2	2.4419.280.0	HC-51040
18	HC7500SUK4HSYN	HC-55260	1	149046	H-7982	RAMA			3	2.4419.280.0/10	HC-51040
19	HC7500SUN4H	HC-55290	POCLAIN			1	JHDP164166	H-5001	4	244192700	HC-45110
20	HC7500SUN8H	HC-7937	1	150566	H-62040	RANSOMERS SIMMS & JEFFRIES			5	244192800	HC-51040
21	HC7500SUS4H	HC-55260	2	C105027	H-76050	1	4121553	HC-55260	6	244196110	H-56580
22	HC7500SUS8H	HC-7937	PONSSE			RAYGO			SAMSUNG		
23	HC7500SUS8H	HC-79372	1	0061012	H-76040	1	134200-02	H-79411	1	103061460	H-2719
24	HC8300FDT16H	H-42260	2	60251	H-76040	2	134200-03	H-79411	2	1031 00 480	H-5803
25	HC8300FDT16Z	H-42260	PORTRADRILL CORPORATION			3	134200-17	H-79411	3	104207040	HC-5602
26	HC8300FKT16H	H-42260	1	143102	H-5001	READY-POWER			4	1141-00040	H-2728
27	HC8300FKT16Z	H-42260	POSTAS			1	120088	H-7976	SANDERSON HYDRAULICS LTD		
28	HC8300FUT16H	H-42260	1	YF1118	H-65030	RECNORD			1	SE014G10B	H-62070
29	HC8300FUT16Z	H-42260	POWER BOSS			1	493309	HC-7919	2	SE045D10B	H-62030
30	HC9600FDN4H	H-7974	1	20531	HC-57020	REFILCO			SANDVIK		
31	HC9600FDT13H	H-55380	2	300359	HC-57020	1	PL-409-25-1	H-7976	1	64103347	H-65030
32	HC9600FKN4H	H-7974	3	3300359	HC-57020	2	PL-409-25-1A	H-7976	2	64115773	H-5001
33	HC9600FKT13H	H-55380	PPM			3	PL-507-10-1	H-79411	3	73832473	H-5001
34	HC9600FKT8H	H-7975	1	J0150566	H-62040	4	PL-507-35-1	H-79411	4	SC73831130	HC-57020
35	HC9600FUN4H	H-7974	2	V1750595	H-76040	RENAULT			SANY		
36	HC9600FUS8H	H-5001	PREMIER EQUIPMENT			1	14057403004400	H-8517	1	12SY0126J8798	H-85870
37	HC9600FUT13H	H-55380	1	EU4051572	H-5001	2	5 000 807 212	H-7102	2	60029588	H-42250
38	HC9600FUT8H	H-7975	PREVOST CAR			3	5 000 807 213	H-7102	3	60200363	H-57050
39	HC9800FUS4H	H-5107	1	19500182	HC-55260	4	5 001 831 431	H-7102	4	A222100000119	H-85590
PARKER			PRIME MOVER			5	60 05 019 565	H-5408	5	B222100000346	H-42180
1	1010010012	H-8515	1	200641	HC-7972	6	6005003243	H-56580	6	PO-CO-01-01430	H-57070
2	907234	H-55310	PRINOTH			RENAULT AGRICULTURE			7	PFX-20X10H	H-85590
3	925773	H-7976	1	118302300	HC-57020	1	6005019559	H-6301	8	SHF0330D010BN/HC	H-62090
4	926169 10C	HC-5511	PRO MATCH			RENAULT TRUCKS(RVI)			SAUER SUNDRAND		
5	926899	H-7976	1	9Y4515	H-65030	1	6005019786	H-65030	1	1511015	H-85521
6	928766	HC-55260	PTI			2	74 20 580 233	H-71180	2	1511042	H-62050
7	929105	H-42260	1	F25-25N	H-7976	REXNORD			3	503933	HC-57020
8	930162	H-55380	2	F25-25NM	H-7976	1	102830460	H-65030	4	544379	HC-57020
9	930163	H-55380	3	F4E050HCB	HC-55290	ROBINS			5	607289	H-85521
10	931438	H-7976	4	F4E051HCB	HC-55290	1	1816562	H-57030	6	9700810	HC-57020
11	937728	H-85110	5	F4F05HCB	HC-55290	ROMA			7	SQC00126	H-62050
12	937729	H-76050	6	F4F05JCB	HC-55260	1	LUS-771	HC-6217	SAVARA		
13	937777Q	H-76040	7	HF3050JFB	H-55380	RONGSUN			1	9.21.519.17	H-79411
14	944028Q	HC-57030	8	HF3050JFV	H-55380	1	RP9133	H-53010	2	92152917	H-65030
15	944039Q	HC-55250	9	HF4-050-DC-B	H-7976	ROTORCOMP			SCANIA		
16	944040Q	HC-55270	PURFLUX			1	R 333	HC-6801	1	1345904	H-7102
17	944044Q	HC-69050	1	LS846	HC-5502	ROVER			2	135 4074	H-85520
18	EO1034	HC-51070	PUROLATOR			1	ABU8545	H-65030	3	1768402	HC-7920
19	G01872	H-42020	1	EP-224-1	H-79411	RUSTON BUCYRUS			4	2002705	HC-7920



Manufacturer's Cross Reference

NO	REFERENCE NO	SAKURA NO	NO	REFERENCE NO	SAKURA NO	NO	REFERENCE NO	SAKURA NO	NO	REFERENCE NO	SAKURA NO
SCHAEFF			SOFIMA			SUMITOMO			SURE FILTER		
1	5003599910	H-4904	3	S 2234 Z	H-7102	14	KRJ15830	H-85680	53	SFH 0143	H-7980
2	5380658088	H-62080	4	S 3412 R	HC-5502	15	KRJ20710	H-85680	54	SFH 0145	HC-51020
SCHAFFER			SOFIMAHYDRAULIC/MODINA			16	KSJ-0011	H-7979	55	SFH 0147	HC-7913
1	15511-03300	H-5202	1	CA151CD1	HC-7905	17	KSJ-1929	H-8502	56	SFH 0151	HC-7911
2	T1551200601	H-2718	2	CA151EMCV1	HC-7911	18	KSJ3836	H-2727	57	SFH 0171	H-5914
SCHOPF			3	CA302ECV1	HC-7907	19	KTJ 1429	H-7939	58	SFH 0180	H-8401
1	50411	HC-7907	4	CH803FV11	H-55380	20	KTJ11630	H-85760	59	SFH 0186	H-85770
SCHROEDER			5	DM102FV1	H-42110	21	LS2800	H-7977	60	SFH 0190	H-2801
1	13TZ25	H-55380	6	RE100FD1	H-62060	22	SH120	H-8544	61	SFH 0197	H-42230
2	5TB25	H-85521	7	RE25CV1	H-85521	SUNFIELD			62	SFH 01P1	H-7923
3	8TS7	H-5001	SOPARIS			1	SP861	H-8545	63	SFH 01P11	H-4101
4	8TZ10	H-5001	1	CV-439	HC-6217	SUNSOURCE			64	SFH 01P12	H-41012
5	BB10	H-7988	SPECIAL ORDER			1	1440832	HC-55290	65	SFH 0200	H-7986
6	CC3/9C3	H-7989	1	981380079110	H-62030	SUNWARD			66	SFH 0201	H-59200
7	K25	H-7976	STAUFF			1	730403000139	H-85810	67	SFH 0210	HC-7926
8	K3	H-7985	1	RD070K20B	H-6301	2	73040300186	H-85770	68	SFH 0216	H-5605
9	MS3	HC-55290	2	RN100E10B	H-62080	SURE FILTER			69	SFH 0220	HC-7934
10	MS3G1087	HC-55290	3	RN100K10B	H-62080	1	SFH 0002	H-5634	70	SFH 0223	HC-6501
11	MS7	HC-55260	4	SE014E10B	H-62070	2	SFH 0003	H-7921	71	SFH 02231	HC-6502
12	MZ10	HC-55260	5	SE014G10B	H-62070	3	SFH 0005	H-7941	72	SFH 0224	H-2706
13	MZ5	HC-55290	6	SE045D10B	H-62030	4	SFH 0006	H-7970	73	SFH 0229	HC-62020
14	SBF0060DZ10B	H-62070	7	SE045E10B	H-62030	5	SFH 0008	HC-5806	74	SFH 0233PS	H-71180
15	SBF0160DZ10B	H-62030	8	SF-6720	HC-5511	6	SFH 0009	H-89050	75	SFH 0240	H-89060
16	SBF7500410B	HC-55260	9	SF-6721	HC-7933	7	SFH 0010	HC-5807	76	SFH 0241	H-89070
17	SBF75004S3B	HC-55290	10	SF6706	HC-55290	8	SFH 0011	H-85720	77	SFH 0250	H-85730
18	SBF75004S7B	HC-55260	11	SF6730	HC-55260	9	SFH 0012	H-1015	78	SFH 0251	HC-7933
19	SBF75004Z10B	HC-55260	12	SFC5820E	HC-7907	10	SFH 0014	HC-8001	79	SFH 02511	HC-79331
20	SBF75004Z5B	HC-55290	13	SP070E10B	H-5001	11	SFH 001A	H-8523	80	SFH 0270	HC-7970
21	SBF830016Z25V	H-42260	14	SP090E20B	H-55380	12	SFH 001A2	H-85235	81	SFH 0276	HC-42090
22	SBF960013S15B	H-55380	STEIGER			13	SFH 0030	H-55340	82	SFH 0288	HC-8805
23	SBF960013Z25B	H-55380	1	13984	H-65030	14	SFH 0031	H-8539	83	SFH 0289	H-7936
24	SBF96008S7B	H-5001	2	13984T1	H-65030	15	SFH 0032	H-79510	84	SFH 0301	H-79330
25	SBF96008Z10B	H-5001	3	18502	HC-1903	16	SFH 0033	H-8541	85	SFH 0308	HC-55170
SEPARATION TECHNOLOGIES			4	28-004	H-79411	17	SFH 0035	H-85670	86	SFH 0324	HC-7928
1	8960L12B08	H-5001	STEPA FARMKRAN			18	SFH 0040	H-2728	87	SFH 0330	HC-5804
2	8960L25B13	H-55380	1	EA079	H-85521	19	SFH 0042	H-5508	88	SFH 0341	H-28020
3	ST6060	H-79411	STEWART & STEVENSON			20	SFH 0056	H-52200	89	SFH 0363	H-57050
4	ST6111	H-7976	1	143754	H-65030	21	SFH 0059	H-7950	90	SFH 0370	H-52050
5	ST6181	H-62040	2	30114BJ	H-65030	22	SFH 0065	H-42140	91	SFH 0373	H-51170
6	ST6311	H-76050	STEYR-DAIMLER-PUCH			23	SFH 0066	H-7965	92	SFH 0387	HC-62010
7	ST6706	HC-55290	1	133700730095	HC-45160	24	SFH 0067	H-42120	93	SFH 0400	H-7995
8	ST6710	HC-5511	2	337.00.73.0095	HC-45160	25	SFH 0068	H-7959	94	SFH 0402	H-51220
9	ST6712	HC-55260	3	33700730095	HC-45160	26	SFH 0070	HC-45150	95	SFH 0403	H-2705
10	ST7962	H-62040	4	37700750066	HC-45150	27	SFH 0071	H-5909	96	SFH 0404	H-2701
11	ST7964	H-76040	5	397750036	HC-45150	28	SFH 0073	H-42160	97	SFH 0409	H-2702
SF-FILTER AG			SULLAIR			29	SFH 0075	H-43010	98	SFH 0410	HC-52010
1	SPH 9247	HC-51060	1	250025-525	HC-79490	30	SFH 0079	H-5403	99	SFH 0411	H-7940
2	SPH 9386	HC-51070	2	250025-526	HC-7973	31	SFH 0080	H-42170	100	SFH 0430	H-2711
SHANTUI			3	250026-982	HC-85030	32	SFH 0083	H-42180	101	SFH 0435	H-2708
1	Y246-78A-070030	H-55340	4	250028-032	HC-85030	33	SFH 0084	H-5107	102	SFH 0437	H-51180
SHIBAURA			5	40800	H-79411	34	SFH 0089	HC-55200	103	SFH 0480	HC-5505
1	SBA340500951	HC-45090	6	5081916	HC-5502	35	SFH 0090	H-5514	104	SFH 0486	HC-1901
2	SBA340500960	HC-45080	7	68500953	HC-5502	36	SFH 0091	H-7922	105	SFH 0488	H-85930
3	SBA340501030	HC-45060	8	70324	HC-7928	37	SFH 0095	HC-45090	106	SFH 0525	HC-2709
SHINTOOL			9	953	HC-5502	38	SFH 0096	H-55310	107	SFH 0540	H-5902
1	A22A2-20701	H-79370	SUMITOMO			39	SFH 00B3	HC-79540	108	SFH 0546	HC-7922
SISU DIESEL			1	430	H-2713	40	SFH 0101	H-42250	109	SFH 0590	H-2713
1	800820026	HC-55250	2	KHJ 0738	H-5609	41	SFH 0103	HC-45060	110	SFH 0599	H-55331
SKYJACK			3	KHJ10950	HC-60010	42	SFH 0107	H-42240	111	SFH 0600	H-5624
1	138404A	HC-55260	4	KNJ0589	HC-5807	43	SFH 0114	H-65010	112	SFH 0601	H-62070
2	J2120149	HC-55260	5	KPJ 1429	H-7939	44	SFH 0116	H-7905	113	SFH 0603	H-85860
SMV			6	KRA 0356	H-7940	45	SFH 0119	H-85590	114	SFH 0608	H-62100
1	S23641236	H-6701	7	KRA 3703	H-2706	46	SFH 0122	H-7938	115	SFH 0630	HC-7931
SNORKEL			8	KRA 4705	H-7911	47	SFH 0123	H-8542	116	SFH 0670	H-5509
1	5080046	HC-42090	9	KRH 4815	HC-7901	48	SFH 0131	H-85231	117	SFH 0676	H-42020
2	JLG212014	HC-55260	10	KRJ 1599	H-5519	49	SFH 0132	H-85232	118	SFH 0694	H-5109
SOFIMA			11	KRJ 3547	H-5518	50	SFH 0136	HC-28130	119	SFH 0701	HC-7941
1	730403000197	H-42230	12	KRJ 3836	H-2727	51	SFH 0139	H-85810	120	SFH 0735	H-5510
2	EF131A	H-85790	13	KRJ10590	H-2713	52	SFH 0141	H-7979	121	SFH 0741E	EH-5503



Manufacturer's Cross Reference

NO	REFERENCE NO	SAKURA NO	NO	REFERENCE NO	SAKURA NO	NO	REFERENCE NO	SAKURA NO	NO	REFERENCE NO	SAKURA NO
SURE FILTER											
122	SFH 0803	H-7958	191	SFH 1405	H-5406	260	SFH 2095	H-85490	329	SFH 3131	H-55270
123	SFH 0811	HC-79500	192	SFH 1408	HC-18051	261	SFH 2096	H-51130	330	SFH 3145	HC-5502
124	SFH 0816	H-5502	193	SFH 1420	H-38010	262	SFH 2103	H-8547	331	SFH 3160	HC-5601
125	SFH 0830PS	H-55420	194	SFH 1429	H-7939	263	SFH 2120	H-7956	332	SFH 3161	H-85920
126	SFH 0861	H-8545	195	SFH 1430	H-7911	264	SFH 2122	H-88080	333	SFH 3187	H-55332
127	SFH 0906	HC-55270	196	SFH 1440	H-5622	265	SFH 2124	H-2725	334	SFH 3194	H-5912
128	SFH 0950	HC-6801	197	SFH 1450	H-5613	266	SFH 2130	H-5602	335	SFH 3197	HC-45020
129	SFH 0951	H-65030	198	SFH 1451	H-6001	267	SFH 2136	HC-8502	336	SFH 3203	H-45030
130	SFH 0960	HC-45080	199	SFH 1460	H-27251	268	SFH 2142	HC-76140	337	SFH 3300	H-5908
131	SFH 0962	HC-6802	200	SFH 1470	H-56610	269	SFH 2150	H-4905	338	SFH 3301	H-7991
132	SFH 0987	H-2714	201	SFH 1479	HC-5501	270	SFH 2163E	EH-55040	339	SFH 3310	H-62090
133	SFH 0L10	HC-5603	202	SFH 1486	HC-1905	271	SFH 2170	H-5607	340	SFH 3321	HC-5602
134	SFH 1000	HC-5810	203	SFH 1493	H-5513	272	SFH 2171	H-5910	341	SFH 3323	HC-7972
135	SFH 1001	H-7914	204	SFH 1510	H-7902	273	SFH 2190	H-88040	342	SFH 3324	HC-7927
136	SFH 1002	H-41060	205	SFH 1517	H-5640	274	SFH 2194	H-52150	343	SFH 3331	H-27241
137	SFH 101Z	H-7104	206	SFH 1518	HC-7905	275	SFH 21T6	HC-56080	344	SFH 3332	H-69030
138	SFH 1030	HC-7944	207	SFH 1534	H-85521	276	SFH 2200	H-1001	345	SFH 3400	HC-5802
139	SFH 1032	HC-7908	208	SFH 1551	HC-19040	277	SFH 2205	HC-5402	346	SFH 3419	HC-7923
140	SFH 1046	H-5637	209	SFH 1553	HC-1903	278	SFH 2209	HC-76090	347	SFH 3420	H-56570
141	SFH 1056	H-7952	210	SFH 1561	H-62060	279	SFH 2210	H-88050	348	SFH 3474	HC-45040
142	SFH 1066	H-42150	211	SFH 1563	HC-7947	280	SFH 2212	H-56530	349	SFH 3483	H-51160
143	SFH 1079	H-38030	212	SFH 1564	H-8902	281	SFH 2256	HC-1902	350	SFH 3490	H-62020
144	SFH 1084	H-42190	213	SFH 1566	HC-7606	282	SFH 2289	H-48320	351	SFH 3540E	EH-55010
145	SFH 1103	HC-1014	214	SFH 1570	H-56680	283	SFH 2301	H-4904	352	SFH 3542	HC-57020
146	SFH 1110	H-7929	215	SFH 1573	H-62050	284	SFH 2337	H-88110	353	SFH 3547	H-5518
147	SFH 1116	H-5635	216	SFH 1580	H-5606	285	SFH 2391	H-5101	354	SFH 3555	HC-55240
148	SFH 1119	H-85820	217	SFH 1591	HC-7906	286	SFH 2410	H-7912	355	SFH 3560	H-5633
149	SFH 1120	H-56710	218	SFH 1599	H-5519	287	SFH 2411	HC-5801	356	SFH 3600	H-58040
150	SFH 1121	H-5639	219	SFH 1600	HC-5511	288	SFH 24112	HC-58012	357	SFH 3607	H-4102
151	SFH 1130	H-7976	220	SFH 1601	HC-79520	289	SFH 2430	HC-8804	358	SFH 3700	H-5204
152	SFH 1140	H-5618	221	SFH 1603	HC-5401	290	SFH 2446	H-7969	359	SFH 3710	H-52090
153	SFH 1141	H-5630	222	SFH 1610	HC-7935	291	SFH 2450	HC-8501	360	SFH 3730	H-52180
154	SFH 1142	H-7920	223	SFH 1622	HC-7966	292	SFH 2460	H-62040	361	SFH 3736	H-5410
155	SFH 1143	H-57070	224	SFH 1630	H-5905	293	SFH 2466	H-76050	362	SFH 3752	H-51190
156	SFH 1150	H-5631	225	SFH 1644	H-85880	294	SFH 2467	H-76040	363	SFH 3760	H-5217
157	SFH 1157	H-56740	226	SFH 1648	HC-7604	295	SFH 2510	H-7978	364	SFH 3771	HC-88010
158	SFH 1160	H-5601	227	SFH 165L	HC-7916	296	SFH 2521	H-8521	365	SFH 3773	H-7981
159	SFH 1163	H-85760	228	SFH 1685	H-7974	297	SFH 2550	H-62030	366	SFH 3780	H-52070
160	SFH 1180	H-5629	229	SFH 1688	H-7975	298	SFH 2558	H-8535	367	SFH 3800	H-5802
161	SFH 1181	H-5646	230	SFH 1696	HC-7910	299	SFH 2566	H-7906	368	SFH 3853	H-5641
162	SFH 1183	HC-57040	231	SFH 1697	HC-7920	300	SFH 2591	HC-88030	369	SFH 3875	H-5507
163	SFH 1197	H-4903	232	SFH 1699	H-5206	301	SFH 2600	HC-18150	370	SFH 3884	H-62120
164	SFH 1200	H-5103	233	SFH 1709	H-42110	302	SFH 2623	HC-8811	371	SFH 3900	H-79861
165	SFH 1201	H-4902	234	SFH 1711	H-5632	303	SFH 26231	HC-88111	372	SFH 3920	H-56580
166	SFH 1202	H-7996	235	SFH 1715	HC-51040	304	SFH 2630	HC-7932	373	SFH 39C3	H-7989
167	SFH 1204	HC-7919	236	SFH 1719	H-5517	305	SFH 2631	HC-5816	374	SFH 4002	H-7903
168	SFH 1207	H-62080	237	SFH 1722	H-5638	306	SFH 2660	H-5919	375	SFH 4020	HC-5803
169	SFH 1209	H-85840	238	SFH 1732	H-5652	307	SFH 2686	H-7105	376	SFH 4026	H-5512
170	SFH 1210	H-1301	239	SFH 1763	H-5208	308	SFH 2688	HC-7101	377	SFH 4041	H-28030
171	SFH 1211	HC-7974	240	SFH 1801	HC-5903	309	SFH 2751	H-7983	378	SFH 4044	HC-45070
172	SFH 1222	H-7910	241	SFH 1803	H-85910	310	SFH 2800	H-7977	379	SFH 4071	H-5918
173	SFH 1235	H-6902	242	SFH 1806	H-5401	311	SFH 2804	H-45050	380	SFH 4074	H-85520
174	SFH 1236	H-6701	243	SFH 1830	HC-5902	312	SFH 2840	H-5623	381	SFH 4086	H-7999
175	SFH 1256	H-5405	244	SFH 1860	HC-7938	313	SFH 2881	H-5907	382	SFH 4100	H-5628
176	SFH 1257	H-57060	245	SFH 1900	H-41030	314	SFH 2910	H-55330	383	SFH 4112	H-56540
177	SFH 1262	HC-1119	246	SFH 1910	H-7987	315	SFH 2914	H-27340	384	SFH 4130	H-2712
178	SFH 1268	HC-85210	247	SFH 1929	H-8502	316	SFH 300	H-7984	385	SFH 4132	H-2717
179	SFH 1275	HC-69050	248	SFH 1933	H-85480	317	SFH 3000	H-5901	386	SFH 4135	H-2719
180	SFH 1280	H-28060	249	SFH 1942	HC-45140	318	SFH 3013	H-5913	387	SFH 4166	H-5001
181	SFH 1290	H-5620	250	SFH 1950	HC-60010	319	SFH 3038	H-7972	388	SFH 4176	H-55380
182	SFH 12F1	H-7990	251	SFH 2000	H-7998	320	SFH 3055	H-85110	389	SFH 4200	H-55320
183	SFH 1301	H-79331	252	SFH 2001	H-5903	321	SFH 3064	H-27390	390	SFH 4201	HC-54040
184	SFH 130N	H-85830	253	SFH 2002	H-59220	322	SFH 3065	H-27380	391	SFH 4211	H-56630
185	SFH 1310	H-28050	254	SFH 2020	H-38050	323	SFH 3078	H-5803	392	SFH 4240	HC-47020
186	SFH 131A	H-85790	255	SFH 2070	H-79370	324	SFH 3087	H-27370	393	SFH 4315	H-88030
187	SFH 1334	H-5505	256	SFH 2071	H-5911	325	SFH 3102	HC-5815	394	SFH 4343	H-56700
188	SFH 1336	H-28040	257	SFH 2081	H-7942	326	SFH 3114	H-5625	395	SFH 4348	HC-55230
189	SFH 1383	H-5649	258	SFH 2085	H-71120	327	SFH 3115	H-56650	396	SFH 4352	HC-6901
190	SFH 1403	H-2707	259	SFH 2086	H-7107	328	SFH 3121	HC-58090	397	SFH 4368	H-62110



Manufacturer's Cross Reference

NO	REFERENCE NO	SAKURA NO	NO	REFERENCE NO	SAKURA NO	NO	REFERENCE NO	SAKURA NO	NO	REFERENCE NO	SAKURA NO
SURE FILTER			SURE FILTER			SURE FILTER			SURE FILTER		
398	SFH 4378	HC-5504	467	SFH 58762	HC-79372	536	SFH 7195	H-55251	605	SFH 86A2	HC-7965
399	SFH 4381	HC-76080	468	SFH 5878	HC-51030	537	SFH 7196	H-55360	606	SFH 8757	H-5525
400	SFH 4384	HC-5508	469	SFH 5928	H-85570	538	SFH 7243	HC-6803	607	SFH 8798	H-85870
401	SFH 4400	H-8517	470	SFH 5929	H-85580	539	SFH 7284	HC-76120	608	SFH 8840	HC-5507
402	SFH 4401	HC-54050	471	SFH 5990	HC-88020	540	SFH 7289	H-85560	609	SFH 8876	H-55280
403	SFH 4452SP	H-2722	472	SFH 6004	H-7915	541	SFH 7310	HC-55180	610	SFH 8877	H-55390
404	SFH 4510	H-76060	473	SFH 6005	H-8518	542	SFH 7352	H-2718	611	SFH 8974	H-57040
405	SFH 4516	H-88060	474	SFH 6007	H-28070	543	SFH 7353	H-2704	612	SFH 9016	H-89030
406	SFH 4522	H-56660	475	SFH 6008	H-7916	544	SFH 7373	H-56431	613	SFH 9031	H-8537
407	SFH 4529	H-28080	476	SFH 6013	H-7917	545	SFH 7376	H-52140	614	SFH 9046	H-7982
408	SFH 4530	H-7961	477	SFH 6025	H-85710	546	SFH 7377	H-52130	615	SFH 9100	HC-7963
409	SFH 4612	H-5515	478	SFH 6030	H-5904	547	SFH 7380	H-5610	616	SFH 9120	H-56670
410	SFH 4615	H-7919	479	SFH 6041	H-71160	548	SFH 7400	H-85630	617	SFH 9130	HC-45110
411	SFH 4622	H-88100	480	SFH 6054	HC-76150	549	SFH 7402	HC-69031	618	SFH 9154	H-51230
412	SFH 4623	H-5408	481	SFH 6060	H-79411	550	SFH 7480	H-55400	619	SFH 9243	H-8538
413	SFH 4699	H-57030	482	SFH 6064	H-5503	551	SFH 7483	H-62010	620	SFH 9243SET	H-8538-S
414	SFH 4726	H-51210	483	SFH 6065	H-5526	552	SFH 7491	H-5202	621	SFH 9247	HC-51060
415	SFH 4729	HC-76130	484	SFH 6071	H-59230	553	SFH 7505	H-85940	622	SFH 9300	HC-79081
416	SFH 4776	H-55350	485	SFH 6094	H-51150	554	SFH 7514	H-7985	623	SFH 9342	HC-45050
417	SFH 4789	H-8546	486	SFH 6095	H-51140	555	SFH 7524	H-7602	624	SFH 9379	H-7101
418	SFH 4801	H-5203	487	SFH 6100	H-41013	556	SFH 7525	H-71190	625	SFH 9386	HC-51070
419	SFH 4950	H-7904	488	SFH 6114	H-56620	557	SFH 7532	H-56590	626	SFH 9392	HC-7929
420	SFH 5001	H-45040	489	SFH 6117	HC-69030	558	SFH 7563	HC-45100	627	SFH 9393	HC-7939
421	SFH 5004	H-41080	490	SFH 6126	H-7934	559	SFH 7580	HC-55280	628	SFH 9482	H-7106
422	SFH 5010	H-8516	491	SFH 6140	HC-7909	560	SFH 7601	HC-1822	629	SFH 9530	HC-57041
423	SFH 5028	H-71170	492	SFH 6141	HC-7901	561	SFH 7606	HC-7603	630	SFH 9565	H-85550
424	SFH 5032	H-76070	493	SFH 6200	HC-7915	562	SFH 7634	H-2709	631	SFH 9615	HC-58073
425	SFH 5075	HC-45030	494	SFH 6208	HC-55310	563	SFH 7660	H-27320	632	SFH 9723	H-7997
426	SFH 5076	H-85890	495	SFH 6212	H-88010	564	SFH 7692	H-5407	633	SFH 9740	H-5504
427	SFH 5080	H-56560	496	SFH 6214	HC-6217	565	SFH 7710	H-88020	634	SFH 9806	H-5522
428	SFH 5110	H-56600	497	SFH 6215	H-88090	566	SFH 7711	HC-5817	635	SFH 9847	HC-2704
429	SFH 5121	H-5636	498	SFH 6221	H-88070	567	SFH 7714	HC-7975	636	SFH 9979	H-2715
430	SFH 5170	H-7913	499	SFH 6236	H-51120	568	SFH 7740	H-51200	637	SFH 9980	H-8522
431	SFH 5171	H-5611	500	SFH 6243	H-42260	569	SFH 7796	H-55370	638	SFH 9992	H-5102
432	SFH 5175	HC-5101	501	SFH 6252	H-8543	570	SFH 7830	HC-7925	639	SFH BB10	H-7988
433	SFH 5180	H-7946	502	SFH 6301	H-7973	571	SFH 7841	H-2703	640	SFH P105	HC-85190
434	SFH 5197	H-38040	503	SFH 6306	H-8515	572	SFH 7900	H-85800	641	SFH S005	H-5643
435	SFH 5208	H-8302	504	SFH 6311	H-89080	573	SFH 7941	HC-7940	642	SFT 6578	TC-7918
436	SFH 5210	H-56550	505	SFH 6316	HC-76110	574	SFH 7950	HC-88060	SWEEPSTER JENKINS		
437	SFH 5250	H-56720	506	SFH 6320	H-5609	575	SFH 8013	HC-69040	1	30890	H-57030
438	SFH 5299	H-2730	507	SFH 6324	H-6301	576	SFH 8040	HC-7924	SWIFT FILTERS,INC.		
439	SFH 5301	HC-7964	508	SFH 6325	HC-7973	577	SFH 8041	HC-7946	1	SF9700-9-25UM	H-7976
440	SFH 5306	H-85700	509	SFH 6359	HC-7907	578	SFH 8116	H-5651	TADANO		
441	SFH 5308	H-38020	510	SFH 6371SET	H-10020-S	579	SFH 8201	H-60020	1	36670030010	H-7914
442	SFH 5318	H-41090	511	SFH 6389	H-53010	580	SFH 8210	H-5608	TAISEI KOGYO		
443	SFH 5335	HC-57030	512	SFH 6450	H-8544	581	SFH 8232	H-8519	1	U-03	H-7921
444	SFH 5354	HC-55220	513	SFH 6455	H-2726	582	SFH 8235	H-8301	TAKEUCHI		
445	SFH 5381	HC-5516	514	SFH 6546	H-85850	583	SFH 8239	H-2720	1	15511-00200	H-7986
446	SFH 5453	HC-55300	515	SFH 6566	HC-55190	584	SFH 8244	HC-7942	2	15511-00700	H-5202
447	SFH 5461	H-5506	516	SFH 6567	HC-7001	585	SFH 8247	HC-7943	3	15511-00803	H-7958
448	SFH 5470	H-85600	517	SFH 6600	HC-52020	586	SFH 8274	HC-76070	4	15511-01910	H-7987
449	SFH 5491	H-85750	518	SFH 6608	H-2724	587	SFH 8276	H-5409	5	15511-02501	H-7978
450	SFH 5500	H-8525	519	SFH 6705	H-2727	588	SFH 8301	H-59210	6	15511-03100	H-88010
451	SFH 5525	HC-79490	520	SFH 6753	H-7962	589	SFH 8310	HC-52030	7	15511-03300	H-5202
452	SFH 5557	H-8526	521	SFH 6837	HC-2701	590	SFH 8332	HC-47010	8	15511-03900	H-79861
453	SFH 5569	HC-5503	522	SFH 6926	HC-76100	591	SFH 8353	H-71140	9	1551200601T	H-5513
454	SFH 5577	H-2716	523	SFH 6930	H-56640	592	SFH 8400	H-5211	TAMPO		
455	SFH 5580	H-85610	524	SFH 6936	H-71130	593	SFH 8401	H-2721	1	81339	HC-57020
456	SFH 5603	H-7601	525	SFH 6982	HC-85030	594	SFH 8402	HC-79530	TAMROCK		
457	SFH 5659	HC-5506	526	SFH 6986	HC-79550	595	SFH 8407	H-27330	1	04698884	HC-55250
458	SFH 5675	HC-5512	527	SFH 6990	HC-18050	596	SFH 8414	H-71150	2	4004011	H-65030
459	SFH 5705	HC-55250	528	SFH 7002	HC-2703	597	SFH 8510	H-28042	3	64103347	H-65030
460	SFH 5779	H-7960	529	SFH 7006	H-7907	598	SFH 8598	H-5516	4	64115773	H-5001
461	SFH 5812	H-51050	530	SFH 7012	HC-2705	599	SFH 8651	H-27360	5	64117540	H-76040
462	SFH 5830	H-85680	531	SFH 7047	HC-55090	600	SFH 8670	HC-9901	6	73831130	HC-57020
463	SFH 5834	H-5501	532	SFH 7051	H-45020	601	SFH 8676	H-5520	7	73831131	HC-57030
464	SFH 5864	HC-7602	533	SFH 7095	HC-45160	602	SFH 8677	H-55201	8	81639699	H-55380
465	SFH 5875	HC-55260	534	SFH 7107	H-7901	603	SFH 8679	H-5614	9	81732769	H-55380
466	SFH 5876	HC-7937	535	SFH 7162	HC-55290	604	SFH 8679B	H-5615	10	81893749	H-5001



Manufacturer's Cross Reference

NO	REFERENCE NO	SAKURA NO	NO	REFERENCE NO	SAKURA NO	NO	REFERENCE NO	SAKURA NO	NO	REFERENCE NO	SAKURA NO
TAMROCK			TIMBERLAND			UFI			VICKERS ARMSTRONG		
11	86727289	H-48320	1	549739	HC-55250	1	22.034.00	H-7102	12	V3R81C10	H-62030
12	86727289	H-85560	TODD			2	23.412.00	HC-5502	13	V6021B2C10	H-5001
TASK UNLIMITED INCORPORATED			1	2246001	H-62050	3	2547701	H-65030	14	V6021B2V10	H-5001
1	9437100555	HC-55250	TORO			4	2556800	H-62040	15	V6021B4C20	H-55380
TAYLOR			1	013170140	H-8515	5	7606200	H-85521	16	V6021B4V20	H-55380
1	2404329	H-57030	2	013170210	HC-57020	6	77.014.00	H-42110	17	VTXX03BC10	H-8515
2	4044454	HC-55250	3	13170210	HC-57020	7	80.014.00	HC-7907	VMC		
3	4044471	HC-57030	4	281370	HC-1903	8	EPB32NFC	H-5001	1	62413976	H-76050
4	4044501	HC-57030	5	74-3570	HC-5511	9	ERA32NCD	H-85521	2	HF163542	HC-57020
5	4404454	HC-55250	6	751310	HC-57030	10	ERA52NFC	H-62060	3	HF163555	HC-55240
6	555775C	H-76040	7	80-76001	HC-5511	11	ERF32NCC	H-85110	4	HF164166	H-5001
TCM			8	86-6110	HC-5512	UNIPART			5	HF164176	H-55380
1	12403-82521	H-8521	TORQUIP CONSTRUCTION			1	ABU8545	H-65030	6	HF164699	H-57030
2	214A7-52081	H-8302	1	9066151	H-57030	UNITED CENTRAL INDUSTRIAL SUPP			7	HF165335	HC-57030
3	216G7-52051	H-8522	TOVMOTOR			1	366545	HC-55260	8	HF165705	HC-55250
4	23457-52221	H-7952	1	329867	H-79411	2	687132	HC-7972	9	HF165875	HC-55260
5	243L7-82001	H-60020	TOYOTA			3	687156	H-5001	10	HF167162	HC-55290
6	25787-80301A	H-59210	1	1001576	H-5902	4	687252	HC-55250	11	HF171534	H-85521
7	25967-80201A	H-59200	2	1001577	H-5901	5	688400	H-42020	12	HF172460	H-62040
8	25967-82002	H-59220	3	25597-60301	H-5904	6	688620	H-65030	13	HF172466	H-76050
9	26267-67002	HC-2703	4	25967-82001	H-5903	UNIVERSAL			14	HF172467	H-76040
TECFIL			5	32405-31940-71	H-5912	1	902188	HC-5511	15	HF173042	H-42020
1	PS-962-H	HC-6217	6	32670-12620-71	HC-1119	UNIVERSAL POWER CONV.			16	HF173055	H-85110
2	PSH582	HC-45050	7	32901-31630-71	H-5905	1	UPC6710W8A	HC-5511	17	HF173702	HC-5516
3	PSH962	HC-6217	8	40666-30130-71	H-5913	UP LIFTING VERTICAL			18	HF179342	HC-45050
4	PSH962H	HC-6217	9	67501-20540-71	H-5918	1	54900A60000070	HC-55250	19	HF550276	HC-42090
TECNO COMP			10	67501-23001-71	H-5914	VALMET, VALTRA TRACTOR, VALTRA-VL			20	HF550951	H-65030
1	TE818	H-62040	11	67501-23320-71	H-8522	1	5006793	HC-57020	21	ST170601	H-62070
2	TE821	H-76050	12	67501-32880-71	H-8526	2	5050618	HC-55240	VME(VOLVO BM/MICH./EUCLID)		
3	TE845	H-85521	13	67501-32881-71	H-8526	3	73002013	H-79411	1	0965899	HC-55250
TEREX			14	67501-41830-71	HC-5902	4	D45161300	HC-62020	2	11036607	HC-5508
1	00420030	H-7961	15	67502-13300-71	H-5908	5	F33867011	HC-51060	3	110366077	HC-5508
2	1448990	H-57030	16	67502-20540-71	H-5902	VANMAM			4	2155026	H-65030
3	15025076	H-85890	17	67502-23000-71	H-5901	1	456590	H-65030	5	2675189	H-65030
4	15266831	H-57040	18	67502-23320-71	H-5911	VAPORMATIC			6	9658998	HC-55250
5	15267046	H-7976	19	67502-26600-71	H-5919	1	11967	H-85521	VOLVO		
6	15275922	H-76040	20	67502-32881-71	H-5907	2	CPK1533	HC-55260	1	0965899	HC-55250
7	15503601	H-57030	21	67502-36760-71	H-59230	3	VPJ4515	HC-57020	2	100462	HC-1903
8	25011193	H-65030	22	67502-F2180-71	H-5919	4	VPK1533	HC-55260	3	1030-61460	H-2719
9	4008687	H-7983	23	67502-U2230-71	H-5919	VERMEER			4	11026932	H-85560
10	4787500	H-65030	24	67503-23321-71	H-5910	1	1096010031	HC-55180	5	110269321	H-85560
11	5572942	H-65030	25	6751-242820-71	HC-7972	2	256554003	HC-55260	6	11026934	H-71150
12	5577106	H-65030	26	67512-41801-71	HC-5903	3	609135003	HC-55170	7	110269341	H-71150
13	5577124	H-65030	27	6752-141930-71	HC-7972	4	609136003	HC-55300	8	110269347	H-71150
14	5620129	H-85521	TREE FARMER			5	67581001	HC-57020	9	11026936-2	H-71130
15	6110604M91	HC-45050	1	7085	H-79411	6	81902001	HC-5507	10	11037650	HC-55190
16	8004936	H-65030	TRIBO GUARD			7	9700810	HC-57020	11	110376506	HC-55190
17	8102636	H-76050	1	060D010N	H-62070	8	ZSE10	HC-55260	12	1141-00010	H-7969
18	8462921	H-62040	2	160D010N	H-62030	VERSATILE			13	11445028	H-71170
19	9038953	H-65010	3	750046UMSF	HC-55260	1	20932	HC-1903	14	11707525	H-71190
20	9066151	H-57030	4	75008100UM	HC-42090	2	26344	H-79411	15	11707544	H-5107
21	TFC45H	HC-45030	5	83001625UM	H-42260	3	63297	H-57030	16	119 3281	H-7102
THOMAS			6	83001625UMV	H-42260	4	704-T-116	H-79411	17	1193281-1	H-7102
1	085154SP	HC-55290	7	9600812UM	H-5001	5	79446	HC-7927	18	11988322	H-55331
TIGERCAT			TRIUMPH			6	CO-11640	H-79411	19	11992372	H-53010
1	AY005	HC-55260	1	96001325UM	H-55380	7	V15801	HC-5511	20	12754597	HC-7933
2	AY052	HC-57040	TROJAN			8	V63297	H-57030	21	12754597	HC-79331
3	AY059	HC-42090	1	7384996	HC-55250	VICKERS ARMSTRONG			22	12754597	HC-7938
TIMBERJACK			2	738499600	HC-55250	1	573082	HC-7901	23	14508017	H-2709
1	549739	HC-55250	TWIN DISC			2	575994SYN	HC-55260	24	14509379	H-7101
2	8428088	HC-7927	1	1001631	HC-57030	3	737724SYN	HC-55260	25	14524170	HC-7901
3	842808800	HC-7927	UCC			4	737847	H-5001	26	14524171	HC-5602
4	894423	H-85521	1	UC-MS-1518-410	HC-7905	5	V0162B1C10	H-62030	27	14532085	H-71120
5	F 008233	H-5001	2	UC-MX-1518-410	HC-7905	6	V0162B1V10	H-62030	28	14532086	H-7107
6	F023753	HC-57020	3	UC-MX-1591-410	HC-7906	7	V0211B1R05	HC-55290	29	14532686	H-7105
7	F058437	H-7602	UCCHYDR			8	V0211B1R10	HC-55260	30	14532688	HC-7101
8	F434370	HC-7001	1	UC-MF-1410-4-25	H-79411	9	V0211B1V05	HC-55290	31	14539482	H-7106
9	KBJ1691	H-2719	2	UCMX1591810	HC-7907	10	V0602B1C10	H-62070	32	15052	H-65030
10	MA 757850	H-71190	3	UCSE1323	H-4903	11	V0602B1V10	H-62070	33	1529253	H-7914



Manufacturer's Cross Reference

NO	REFERENCE NO	SAKURA NO	NO	REFERENCE NO	SAKURA NO	NO	REFERENCE NO	SAKURA NO	NO	REFERENCE NO	SAKURA NO
VOLVO			WESTERN FILTER			WIX			WOODGATE		
34	20580233	H-71180	3	E0211B1R10	HC-55260	38	51663	HC-7901	5	WGH1945	HC-5505
35	208151	HC-55300	4	E0411B5C20	H-42260	39	51677	H-2711	6	WGH1952	H-62110
36	2155026	H-65030	5	E0411V5C20	H-42260	40	51680	HC-7973	7	WGH1962	H-5632
37	2675189	H-65030	6	E6020B3U25	H-55380	41	51683	H-5001	8	WGH1964	H-57040
38	40141558	H-65030	7	EM352B1R20	HC-57020	42	51685	H-7974	9	WGH1982	H-7956
39	4787923	HC-6802	8	EM352B3R20	HC-55240	43	51688	H-7975	10	WGH3301	H-7991
40	62413976	H-76050	9	EM502V3R20	HC-69050	44	51690	H-55380	11	WGH6060	H-79411
41	6617506	H-65030	10	ER171B2P10	H-62040	45	51715	HC-51040	12	WGH6225	H-65030
42	66175068	H-65030	11	ER171B5C10	H-76040	46	51720	HC-5505	13	WGH6287	H-57030
43	6638403	H-71140	12	ER171B5P10	H-76050	47	51724	HC-7929	14	WGH6294	H-57030
44	6643628	H-79411	13	ET151B1P20	H-85521	48	51724	HC-7939	15	WGH6572	HC-57020
45	79011572	H-71140	14	ET151V1P20	H-85521	49	51730	HC-5503	16	WGH6573	HC-55240
46	79211272	H-65030	WESTERN STAR			50	51733	HC-55250	17	WGH6588	HC-5512
47	874487	H-71160	1	196446	HC-55250	51	51759	HC-5511	18	WGH6723	HC-42090
48	965899	HC-55250	2	E0250-B-T25	H-7976	52	51816	H-5502	19	WGH7535	HC-7920
49	9658998	HC-55250	WHITE			53	51816	H-5508	20	WGH7541	HC-79081
50	M0965899	HC-55250	1	10P-3932	H-79411	54	51818	HC-6217	21	WGH9100	H-85521
51	SA1141-00010	H-7969	2	20P-3339	H-79411	55	51826	HC-6901	22	WGH9104	H-5202
52	VOE1141-00010	H-7969	3	30-3022161	H-79411	56	51860	HC-7933	23	WGH9134	H-2705
53	VOE11455028	H-71170	4	3902287M1	H-7975	57	51860	HC-7938	24	WGH9159	H-51220
VOLVO (TRUCK/VCE/VME/PENTA)			5	E6020B2U10	H-5001	58	51861	HC-19060	25	WGH9164	H-6701
1	1913281-1	H-7102	6	E6020B3U25	H-55380	59	551454	HC-57030	26	WGH9180	HC-7907
2	3098081	H-7102	WILLMAR			60	551527	H-57030	27	WGH9580	H-62050
VOLVO BM			1	25412	HC-55260	61	551533	H-5610	28	WGH962-14	HC-6217
1	9658998	HC-5503	WINSLOW			62	551543	H-57030	29	WGH30010DB	H-55331
VOLVO CONSTRUCTION EQUIPMENT			1	CLPF151	H-65030	63	551544	H-57030	30	WGL691	HC-5502
1	104207040	HC-5602	2	WPF151	H-65030	64	551605	H-5620	31	WGL9126	H-2717
2	M1965899	HC-55250	WIRTGEN			65	551648	HC-7604	32	WGP9608	H-5001
VOOLCO FILTER			1	156576	H-85900	66	551677	H-2711	33	WGPN9608	HC-55260
1	VO1256	HC-76110	WISMET			67	551715	HC-51040	34	WGPN9608	H-5001
WABCO			1	WSH 46393	HC-85210	68	551720	HC-5505	35	WGPT9613	H-55380
1	4068356	H-57030	WIX			69	551733	HC-55250	36	WGTW8BCC25	H-71130
2	PB5038	H-65030	1	449	HC-57030	70	557084	HC-5512	37	WGTW8CCC10	H-76040
3	SU6848	H-65030	2	451	HC-57020	71	557401	HC-69031	WORTHINGTON		
4	VF-4454	H-7976	3	51163	H-5504	72	557407	H-53010	1	6211472200	HC-6217
5	VS-0654	H-79411	4	51176	H-65030	73	557421	HC-1905	2	FLR170	H-65030
6	YW-6458	H-79411	5	51194	H-5506	74	557606	HC-7603	XGMA		
WAGNER			6	51197	H-5503	75	557608	HC-42090	1	53C0011	H-85720
1	243622	HC-55250	7	51197	H-5526	76	57084	HC-5512	2	60C0010	H-42140
2	372192	HC-57020	8	51235	H-6902	77	57115	HC-5516	3	60C0011	H-42160
WAKO			9	51405	H-5406	78	57184	HC-55180	4	60C0025	H-85710
1	WP 110	HC-5801	10	51412	H-5618	79	57201	HC-76110	YALE & TOWNE		
WALGAHN-MOTORENTECHN			11	51420	H-5501	80	57220	HC-45050	1	2016336	H-65030
1	00810491	HC-7972	12	51426	H-65030	81	57397	HC-55300	2	2039875	H-65030
2	00810941	HC-7972	13	51434	H-7976	82	57401	HC-69031	3	2071644	H-79411
3	00810947	HC-7972	14	51439	H-57030	83	57407	H-53010	4	505966578	TC-7918
4	00810952	HC-57020	15	51447	HC-57020	84	57418	HC-55280	5	5610	HC-7935
5	00810953	HC-55240	16	51449	HC-57030	85	57608	HC-42090	6	6955207	H-65030
6	00810959	H-5001	17	51451	HC-57020	86	57700	H-7973	7	9071606-01	HC-7901
7	00810964	H-55380	18	51454	HC-57030	87	57709	HC-76070	8	917380400	H-7995
8	00811016	HC-55250	19	51479	HC-5501	88	57724	HC-55170	YAMASHIN		
9	00811018	HC-55250	20	51482	HC-7972	89	57740	H-8537-S	1	15510-00220	HC-7934
10	00811848	H-76050	21	51485	HC-7972	90	57852	H-5001	2	15511-03700T	H-52050
11	00890060	H-85521	22	51486	HC-55240	91	59084	H-5001	3	C-SP-08N-30	HC-7901
12	810889	H-57030	23	51510	H-57030	92	733	HC-55250	4	C-SP04-10	HC-52010
13	810902	H-57030	24	51517	H-5640	93	A20A03GV	HC-55270	5	CSP-10-30	HC-7944
14	810907	H-57030	25	51519	HC-7919	94	CW-1567-P	H-79411	6	CSP-10L-10	HC-5603
15	810908	H-57030	26	51527	H-57030	95	D37B20GV	H-62030	7	CSP-10L-30	HC-5401
16	811352	H-65030	27	51535	H-57030	96	D40B10GV	H-55331	8	DT-04-10-10	H-2719
WARNER & SWASEY			28	51543	H-57030	97	D82E10GV	H-62070	9	RD 411-6212-0	H-88010
1	76102474	H-57030	29	51544	H-57030	98	R06D10G	H-51050	10	Y4649	H-7990
WARTSILA DIESEL			30	51551	HC-45100	99	R18D25C	H-76050	YANMAR		
1	5611-F-216	H-5605	31	51565	HC-7601	100	W01AG633	H-62120	1	151103700T	H-52050
WEGA			32	51565	HC-7606	101	W02AP420	H-5519	2	15511-00200	H-7986
1	WEO-0017	H-5504	33	51567	H-79411	WOODGATE			3	15511-00700	H-5202
2	WEO-514	H-5502	34	51586	HC-76100	1	WGAL3721	H-42020	4	1551103700T	H-52050
WESTERN FILTER			35	51610	HC-7935	2	WGH1736	H-6701	5	172112-74801	H-5203
1	200003-1	H-8539	36	51632	HC-55260	3	WGH1845	HC-45050	6	172112-74911	H-5202
2	E0211B1R05	HC-55290	37	51648	HC-7604	4	WGH1894	HC-7973	7	172137-73700	H-5204



Manufacturer's Cross Reference

NO	REFERENCE NO	SAKURA NO
YANMAR		
8	172141-73760	H-5625
9	172146-73730	H-5217
10	172156-73700	HC-7914
11	172162-73700	H-2706
12	172175-73710	H-5634
13	172187-73060	H-7986
14	172194-73730	H-52150
15	172448-73780	H-52070
16	172482-73730	H-52180
17	172484-73730	H-4903
18	172486-73710	H-52090
19	172638-73730	HC-52010
20	172837-73730	H-56431
21	172A59-73770	H-52130
22	172B11-73710	H-79861
23	172B11-73760	H-52140
24	1A811548310	HC-52030
25	YM172175-73710	H-5634
26	YM172175-73710A	H-5634
YSK		
1	IHI-075511900	HC-5807
2	IHI-517006	H-7907
YUCHAI		
1	820-8514200	H-38010
2	8530-0503201	H-42170
3	860A-051330	H-38030
ZANOTTI		
1	1978	HC-55250
ZF		
1	0501 203 018	H-7102
2	0501323154	HC-76130
3	050132315401	HC-76130
4	0750 131 003	H-7102
5	0750131012	HC-76110
6	0750131032	HC-76110
7	075013106101	HC-76130
8	4139 298 038	H-7102
9	4139 298 936	H-7102
10	50131012	HC-76110
11	501323154	HC-76130
12	50132315401	HC-76130
13	750 131 003	H-7102
14	750131012	HC-76110
15	750131056	HC-76110
16	750131061	HC-76130
17	750131063	HC-6802
18	763 160 114 534	H-71180
19	763 160 114 534-01	H-71180
ZINGA		
1	C-23012-25	H-79411
2	GCE-10	HC-5511
3	LE100	HC-42090
4	LE25	HC-7938
5	ME03L	HC-7972
6	RE-25	H-7976
7	SE-10	HC-5511
8	SRE-409-10	H-7976
9	SRE-409-25	H-7976
10	W0810LN	H-5001
11	W1320LN	H-55380
12	XME10	HC-57020
13	Y1625LN	H-42260
14	Z-23012-25	H-79411
15	Z-23013-25	H-79411
16	ZSE10P	HC-55260
ZOOMLINE		
1	1010600488	H-85930

















Technical Specification

B











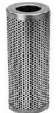





Technical Specification

<p>EH-55010</p> <p>Hydraulic Oil Filter Transmission Eco Element with adhesive</p> <p>CATERPILLAR 1R-1809 CATERPILLAR 328-3655 CATERPILLAR 338-3540</p>  <p>H 1 : 266 (mm) OD 1 : 124 (mm) OD 2 : 123 (mm) ID 1 : 52 (mm)</p> <p>CONT : 20 VOL : 0.103</p> <p>Note : High efficiency</p>	<p>H-1015</p> <p>Hydraulic Oil Filter Metal End Cap Element</p> <p>KATO 689-37310012</p>  <p>H 1 : 279 (mm) H 2 : 275 (mm) OD 1 : 113.5 (mm) OD 2 : 113.5 (mm) ID 1 : 72.5 (mm) ID 2 : 72.5 (mm)</p> <p>CONT : 12 VOL : 0.049</p>	<p>H-2704</p> <p>Hydraulic Oil Filter Metal End Cap Element</p> <p>DAEWOO 2474-9003B DAEWOO 2474-9008 HITACHI 4227353</p>  <p>H 1 : 456 (mm) H 2 : 438 (mm) OD 1 : 112 (mm) OD 2 : 112 (mm) ID 1 : 66.1 (mm) ID 2 : 66.1 (mm)</p> <p>CONT : 10 VOL : 0.079</p>
<p>EH-5503</p> <p>Hydraulic Oil Filter Eco Element with adhesive</p> <p>CATERPILLAR 1R-0741 CATERPILLAR 1R-0778</p>  <p>H 1 : 228.5 (mm) OD 1 : 129.5 (mm) OD 2 : 129.5 (mm) ID 1 : 84 (mm) ID 2 : 84 (mm)</p> <p>CONT : 20 VOL : 0.103</p> <p>Note : Is a Ecological version of H-5503,H-5526</p>	<p>H-1301</p> <p>Hydraulic Oil Filter Metal End Cap Element</p> <p>HINO 44308-1210</p>  <p>H 1 : 91.6 (mm) H 2 : 90 (mm) OD 1 : 64.6 (mm) OD 2 : 64.6 (mm) ID 1 : 36.4 (mm)</p> <p>CONT : 25 VOL : 0.015</p>	<p>H-2705</p> <p>Hydraulic Oil Filter Metal End Cap Element</p> <p>HITACHI 4225846 KOBELCO H 403</p>  <p>H 1 : 358 (mm) H 2 : 344 (mm) OD 1 : 90 (mm) OD 2 : 90 (mm) ID 1 : 47 (mm) ID 2 : 47 (mm)</p> <p>CONT : 20 VOL : 0.084</p>
<p>EH-55040</p> <p>Hydraulic Oil Filter Eco Element</p> <p>CATERPILLAR 362-1163</p>  <p>H 1 : 298 (mm) H 2 : 274 (mm) OD 1 : 107 (mm) OD 2 : 107 (mm) ID 1 : 38 (mm)</p> <p>CONT : 25 VOL : 0.139</p>	<p>H-2701</p> <p>Hydraulic Oil Filter Metal End Cap Element</p> <p>HITACHI 315041 KOBELCO H 404</p>  <p>H 1 : 200.6 (mm) H 2 : 190 (mm) OD 1 : 73 (mm) OD 2 : 73 (mm) ID 1 : 34.6 (mm) ID 2 : 34.6 (mm)</p> <p>CONT : 20 VOL : 0.050</p>	<p>H-2706</p> <p>Hydraulic Oil Filter Wire Mesh supported Element</p> <p>YANMAR 172162-73700 HITACHI 4210224</p>  <p>H 1 : 134.8 (mm) H 2 : 128 (mm) OD 1 : 150 (mm) OD 2 : 150 (mm) ID 1 : 87 (mm) Thread Size : M10X1.5</p> <p>CONT : 6 VOL : 0.028</p>
<p>H-1001</p> <p>Hydraulic Oil Filter Metal End Cap Element</p> <p>MITSUBISHI PE-2200</p>  <p>H 1 : 385 (mm) H 2 : 381 (mm) OD 1 : 113.6 (mm) OD 2 : 113.6 (mm) ID 1 : 72 (mm) ID 2 : 72 (mm)</p> <p>CONT : 6 VOL : 0.039</p>	<p>H-2702</p> <p>Hydraulic Oil Filter Metal End Cap Element</p> <p>DAEWOO 2474-1001 HITACHI 4159320 KOBELCO H 409</p>  <p>H 1 : 123.6 (mm) H 2 : 113 (mm) OD 1 : 73 (mm) OD 2 : 73 (mm) ID 1 : 34 (mm)</p> <p>CONT : 50 VOL : 0.030</p>	<p>H-2707</p> <p>Hydraulic Oil Filter Wire Mesh supported Element</p> <p>HITACHI 3501403</p>  <p>H 1 : 102 (mm) H 2 : 90 (mm) OD 1 : 150 (mm) OD 2 : 150 (mm) ID 1 : 73.4 (mm) ID 2 : 73.4 (mm)</p> <p>CONT : 9 VOL : 0.033</p>
<p>H-10020-S</p> <p>Hydraulic Oil Filter Metal End Cap Element</p> <p>MITSUBISHI ME536371</p>  <p>H 1 : 107 (mm) H 2 : 104 (mm) OD 1 : 81.5 (mm) OD 2 : 81.5 (mm) ID 1 : 37 (mm)</p> <p>CONT : 10 VOL : 0.023</p> <p>Note : 1 set= 2 pcs filter</p>	<p>H-2703</p> <p>Hydraulic Oil Filter Metal End Cap Element</p> <p>HITACHI 4207841 HITACHI 4207841A HITACHI 4370435</p>  <p>H 1 : 152 (mm) H 2 : 146.5 (mm) OD 1 : 51 (mm) OD 2 : 51 (mm) ID 1 : 23.5 (mm)</p> <p>CONT : 25 VOL : 0.015</p>	<p>H-2708</p> <p>Hydraulic Oil Filter Metal End Cap Element</p> <p>HITACHI 4370435</p>  <p>H 1 : 151 (mm) H 2 : 145.5 (mm) OD 1 : 51 (mm) OD 2 : 50.5 (mm) ID 1 : 23.5 (mm)</p> <p>CONT : 25 VOL : 0.014</p> <p>Note : H-2703 (Outer tube Difference)</p>

















Technical Specification

<p>H-2709</p> <p>Hydraulic Oil Filter Metal End Cap Element</p> <p>KOMATSU 07063-01383 KOMATSU 208-60-61150 HITACHI 4287634 HITACHI 76580323</p>  <p>H 1 : 450 (mm) OD 1 : 180 (mm) OD 2 : 180 (mm) ID 1 : 110 (mm) ID 2 : 110 (mm)</p> <p>CONT : 9 VOL : 0.173</p>	<p>H-2715</p> <p>Hydraulic Oil Filter Wire Mesh supported Element</p> <p>FIAT 71407523</p>  <p>H 1 : 163.5 (mm) H 2 : 157 (mm) OD 1 : 200 (mm) OD 2 : 200 (mm) ID 1 : 112.8 (mm) Thread Size : M10X1.5</p> <p>CONT : 9 VOL : 0.079</p>	<p>H-2720</p> <p>Hydraulic Oil Filter Metal End Cap Element</p> <p>HITACHI 4488239</p>  <p>H 1 : 111.5 (mm) H 2 : 108.5 (mm) OD 1 : 42.5 (mm) OD 2 : 42.5 (mm) ID 1 : 21.5 (mm)</p> <p>CONT : 50 VOL : 0.014</p>
<p>H-2711</p> <p>Hydraulic Oil Filter Metal End Cap Element</p> <p>HITACHI 76040430</p>  <p>H 1 : 459 (mm) H 2 : 453 (mm) OD 1 : 152 (mm) OD 2 : 152 (mm) ID 1 : 69 (mm) ID 2 : 69 (mm)</p> <p>CONT : 6 VOL : 0.082</p> <p>Note : reverse flow</p>	<p>H-2716</p> <p>Hydraulic Oil Filter Wire Mesh supported Element</p> <p>HITACHI 4285577</p>  <p>H 1 : 137 (mm) H 2 : 129.5 (mm) OD 1 : 124 (mm) OD 2 : 124 (mm) ID 1 : 73.4 (mm) Thread Size : M10X1.5</p> <p>CONT : 20 VOL : 0.061</p>	<p>H-2721</p> <p>Hydraulic Oil Filter Metal End Cap Element</p> <p>HITACHI 4448401 HITACHI 4489239</p>  <p>H 1 : 527 (mm) H 2 : 484 (mm) OD 1 : 111.6 (mm) OD 2 : 111.6 (mm) ID 1 : 13 (mm) ID 2 : 57 (mm)</p> <p>CONT : 6 VOL : 0.053</p> <p>Note : high performance grade uses H-2722</p>
<p>H-2712</p> <p>Hydraulic Oil Filter Metal End Cap Element</p> <p>MANITOU 15512-00703 HITACHI 4294130</p>  <p>H 1 : 52 (mm) H 2 : 48.5 (mm) OD 1 : 42.5 (mm) OD 2 : 42.5 (mm) ID 1 : 21.5 (mm)</p> <p>CONT : 50 VOL : 0.007</p>	<p>H-2717</p> <p>Hydraulic Oil Filter Aluminium Casting Element</p> <p>HITACHI 4294132</p>  <p>H 1 : 211 (mm) H 2 : 180 (mm) OD 1 : 90 (mm) OD 2 : 90 (mm) ID 1 : 41.5 (mm) Thread Size : 1 1/4"X13 BSPT</p> <p>CONT : 25 VOL : 0.067</p>	<p>H-2722</p> <p>Hydraulic Oil Filter Element Synthetic Media</p> <p>HITACHI 4450002</p>  <p>H 1 : 527 (mm) H 2 : 484 (mm) OD 1 : 111.6 (mm) OD 2 : 111.6 (mm) ID 1 : 13 (mm) ID 2 : 57 (mm)</p> <p>CONT : 10 VOL : 0.089</p>
<p>H-2713</p> <p>Hydraulic Oil Filter Wire Mesh supported Element</p> <p>SUMITOMO KRJ10590</p>  <p>H 1 : 197.3 (mm) H 2 : 190.5 (mm) OD 1 : 150 (mm) OD 2 : 150 (mm) ID 1 : 87 (mm) Thread Size : M10X1.5</p> <p>CONT : 9 VOL : 0.061</p>	<p>H-2718</p> <p>Hydraulic Oil Filter Metal End Cap Element</p> <p>CATERPILLAR 997352</p>  <p>H 1 : 83 (mm) H 2 : 77.5 (mm) OD 1 : 51 (mm) OD 2 : 53 (mm) ID 1 : 23.5 (mm)</p> <p>CONT : 50 VOL : 0.016</p>	<p>H-2724</p> <p>Hydraulic Oil Filter Metal End Cap Element</p> <p>HITACHI 4656605 HITACHI 4656608</p>  <p>H 1 : 450 (mm) H 2 : 437 (mm) OD 1 : 154 (mm) OD 2 : 150 (mm) ID 1 : 95 (mm) ID 2 : 98 (mm)</p> <p>CONT : 6 VOL : 0.082</p> <p>Note : High performance grade uses H-27241</p>
<p>H-2714</p> <p>Hydraulic Oil Filter Wire Mesh supported Element</p> <p>HITACHI 4190987</p>  <p>H 1 : 128 (mm) H 2 : 89 (mm) OD 1 : 150 (mm) OD 2 : 150 (mm) ID 1 : 73.4 (mm)</p> <p>CONT : 9 VOL : 0.044</p>	<p>H-2719</p> <p>Hydraulic Oil Filter Metal End Cap Element Cellulose media</p> <p>HYUNDAI 31E3-0018 HITACHI 4294135 YAMASHIN DT-04-10-10</p>  <p>H 1 : 87 (mm) H 2 : 83.5 (mm) OD 1 : 42.5 (mm) OD 2 : 42.5 (mm) ID 1 : 21.5 (mm)</p> <p>CONT : 50 VOL : 0.012</p> <p>Note : Wiremesh type uses H-5211</p>	<p>H-27241</p> <p>Hydraulic Oil Filter Metal End Cap Element with synthetic media</p> <p>HITACHI 4656609 HITACHI 4683331</p>  <p>H 1 : 450 (mm) H 2 : 437 (mm) OD 1 : 154 (mm) OD 2 : 150 (mm) ID 1 : 95 (mm) ID 2 : 98 (mm)</p> <p>CONT : 6 VOL : 0.080</p>



Technical Specification

<p>H-2725</p> <p>Hydraulic Oil Filter Metal End Cap Element</p> <p>HYUNDAI E131-0212 HYUNDAI E131-0212-4</p>  <p>H 1 : 455 (mm) H 2 : 450 (mm) OD 1 : 150 (mm) OD 2 : 150 (mm) ID 1 : 85 (mm) ID 2 : 85 (mm)</p> <p>CONT : 6 VOL : 0.082</p>	<p>H-2730</p> <p>Hydraulic Oil Filter Metal End Cap Element</p> <p>HITACHI 4185299</p>  <p>H 1 : 304 (mm) H 2 : 254 (mm) OD 1 : 140 (mm) OD 2 : 140 (mm) ID 1 : 20 (mm) ID 2 : 20 (mm)</p> <p>CONT : 4 VOL : 0.035</p>	<p>H-27360</p> <p>Hydraulic Oil Filter Wire Mesh supported Element</p> <p>HITACHI 4648651</p>  <p>H 1 : 135.5 (mm) H 2 : 127 (mm) OD 1 : 125 (mm) OD 2 : 125 (mm) ID 1 : 87 (mm) Thread Size : M10X1.5</p> <p>CONT : 25 VOL : 0.076</p>
<p>H-27251</p> <p>Hydraulic Oil Filter Metal End Cap Element with synthetic media</p> <p>HYUNDAI 31N4-01460</p>  <p>H 1 : 455.4 (mm) H 2 : 450 (mm) OD 1 : 150 (mm) OD 2 : 150 (mm) ID 1 : 85 (mm) ID 2 : 85 (mm)</p> <p>CONT : 4 VOL : 0.058</p>	<p>H-27320</p> <p>Hydraulic Oil Filter Wire Mesh supported Element</p> <p>HITACHI 4237660</p>  <p>H 1 : 195.5 (mm) H 2 : 189 (mm) OD 1 : 200 (mm) OD 2 : 200 (mm) ID 1 : 112.8 (mm) Thread Size : M10X1.5</p> <p>CONT : 4 VOL : 0.044</p> <p>Note : H-27321 (Media wire mesh difference)</p>	<p>H-27370</p> <p>Hydraulic Oil Filter Metal End Cap Element</p> <p>HITACHI YD00003087</p>  <p>H 1 : 358 (mm) H 2 : 344 (mm) OD 1 : 90 (mm) OD 2 : 90 (mm) ID 1 : 46.9 (mm) ID 2 : 46.9 (mm)</p> <p>CONT : 25 VOL : 0.120</p>
<p>H-2726</p> <p>Hydraulic Oil Filter Element With Glass Fiber Media</p> <p>MC CORMICK (LANDINI-ARGO) 3556455M1</p>  <p>H 1 : 117.5 (mm) H 2 : 112 (mm) OD 1 : 51 (mm) OD 2 : 51 (mm) ID 1 : 23.5 (mm)</p> <p>CONT : 25 VOL : 0.013</p>	<p>H-27321</p> <p>Hydraulic Oil Filter Wire Mesh supported Element</p> <p>DOOSAN 24719401A</p>  <p>H 1 : 196.5 (mm) H 2 : 190 (mm) OD 1 : 200 (mm) OD 2 : 200 (mm) ID 1 : 112.8 (mm) Thread Size : M10X1.5</p> <p>CONT : 4 VOL : 0.044</p> <p>Note : H-27320(Media wire mesh difference)</p>	<p>H-27380</p> <p>Hydraulic Oil Filter Return Metal End Cap Element</p> <p>HITACHI YA00033065</p>  <p>H 1 : 461.5 (mm) H 2 : 431 (mm) OD 1 : 154 (mm) OD 2 : 150 (mm) ID 1 : 98 (mm)</p> <p>CONT : 6 VOL : 0.081</p> <p>Note : BPV=1.5 kgf/cm2</p>
<p>H-2727</p> <p>Hydraulic Oil Filter Element Cellulose media</p> <p>HITACHI 4206705 HITACHI 4287061 KOMATSU F25701500 SUMITOMO KRJ 3836</p>  <p>H 1 : 455 (mm) H 2 : 450 (mm) OD 1 : 150 (mm) OD 2 : 150 (mm) ID 1 : 110 (mm) ID 2 : 110 (mm)</p> <p>CONT : 6 VOL : 0.081</p>	<p>H-27330</p> <p>Hydraulic Oil Filter Metal End Cap Element with synthetic media</p> <p>HITACHI 4358407</p>  <p>H 1 : 203 (mm) H 2 : 193 (mm) OD 1 : 82 (mm) OD 2 : 82 (mm) ID 1 : 41 (mm)</p> <p>CONT : 12 VOL : 0.022</p>	<p>H-27390</p> <p>Hydraulic Oil Filter Return Metal End Cap Element</p> <p>HITACHI YA00033064</p>  <p>H 1 : 461.5 (mm) H 2 : 431 (mm) OD 1 : 150 (mm) OD 2 : 154 (mm) ID 1 : 98 (mm)</p> <p>CONT : 6 VOL : 0.081</p>
<p>H-2728</p> <p>Hydraulic Oil Filter Metal End Cap Element</p> <p>SAMSUNG 1141-00040 KOBELCO YN50V00001P1</p>  <p>H 1 : 452.5 (mm) H 2 : 450 (mm) OD 1 : 150 (mm) OD 2 : 150 (mm) ID 1 : 110 (mm) ID 2 : 110 (mm)</p> <p>CONT : 10 VOL : 0.134</p>	<p>H-27340</p> <p>Hydraulic Oil Filter Metal End Cap Element</p> <p>HITACHI 4402914</p>  <p>H 1 : 300 (mm) OD 1 : 89 (mm) OD 2 : 89 (mm) ID 1 : 60 (mm) ID 2 : 60 (mm)</p> <p>CONT : 12 VOL : 0.043</p>	<p>H-2801</p> <p>Hydraulic Oil Filter Wire Mesh supported Element</p> <p>HYUNDAI 31E9-10190</p>  <p>H 1 : 213.2 (mm) H 2 : 192 (mm) OD 1 : 197.5 (mm) OD 2 : 200 (mm) ID 1 : 95 (mm) Thread Size : M12X1.75</p> <p>CONT : 4 VOL : 0.045</p>



Technical Specification

H-28020 Hydraulic Oil Filter Metal End Cap Element
HYUNDAI 34L3-00341



H 1 : 154 (mm)
H 2 : 150 (mm)
OD 1 : 148.5 (mm)
OD 2 : 148.5 (mm)
ID 1 : 84 (mm)
ID 2 : 84 (mm)

CONT : 18
VOL : 0.086

H-28060 Hydraulic Oil Filter Metal End Cap Element
HYUNDAI 31Q6-01280



H 1 : 455 (mm)
H 2 : 442 (mm)
OD 1 : 150 (mm)
OD 2 : 150 (mm)
ID 1 : 83.5 (mm)
ID 2 : 85 (mm)

CONT : 4
VOL : 0.045

Note : Hyundai Excavator R210LC-9,R235 LCR-9

H-38030 Hydraulic Oil Filter Metal End Cap Element
YUCHAI 860A-051330



H 1 : 113.4 (mm)
H 2 : 88 (mm)
OD 1 : 150 (mm)
OD 2 : 150 (mm)
ID 1 : 87 (mm)
Thread Size : M10X1.5

CONT : 6
VOL : 0.024

H-28030 Hydraulic Oil Filter Metal End Cap Element
HYUNDAI 31L1-4041



H 1 : 206 (mm)
H 2 : 202 (mm)
OD 1 : 148.5 (mm)
OD 2 : 148.5 (mm)
ID 1 : 84 (mm)
ID 2 : 84 (mm)

CONT : 9
VOL : 0.056

H-28070 Hydraulic Oil Filter Metal End Cap Element
HYUNDAI 31LH-60070



H 1 : 205.4 (mm)
H 2 : 200 (mm)
OD 1 : 150 (mm)
OD 2 : 150 (mm)
ID 1 : 85 (mm)
ID 2 : 85 (mm)

CONT : 9
VOL : 0.062

Note : for Hyundai Wheel Loader HL730-7A

H-38040 Hydraulic Oil Filter Metal End Cap Element
GUANGXI LIUGONG MACHINERY 53C0197



H 1 : 74.5 (mm)
H 2 : 71.5 (mm)
OD 1 : 53 (mm)
OD 2 : 53 (mm)
ID 1 : 20 (mm)

CONT : 50
VOL : 0.017

H-28040 Hydraulic Oil Filter Metal End Cap Element Cellulose media
HYUNDAI 31E9-1019



H 1 : 355.4 (mm)
H 2 : 350 (mm)
OD 1 : 150 (mm)
OD 2 : 150 (mm)
ID 1 : 85 (mm)
ID 2 : 85 (mm)

CONT : 4
VOL : 0.045

Note : for Hyundai Excavator MB-P90

H-28080 Hydraulic Oil Filter Metal End Cap Element
HYUNDAI 31E3-4529



H 1 : 172 (mm)
H 2 : 151 (mm)
OD 1 : 150 (mm)
OD 2 : 150 (mm)
ID 1 : 73.4 (mm)
Thread Size : M12X1.75

CONT : 6
VOL : 0.035

H-38050 Hydraulic Oil Filter Metal End Cap Element
FOTON 9F653-31A020200A0



H 1 : 293.5 (mm)
H 2 : 289.5 (mm)
OD 1 : 79 (mm)
OD 2 : 79 (mm)
ID 1 : 43 (mm)

CONT : 25
VOL : 0.067

H-28042 Hydraulic Oil Filter Metal End Cap Element With Glass Fiber Media
HYUNDAI 31N8-01510



H 1 : 355.4 (mm)
H 2 : 350 (mm)
OD 1 : 150 (mm)
OD 2 : 150 (mm)
ID 1 : 85 (mm)
ID 2 : 85 (mm)

CONT : 4
VOL : 0.045

H-38010 Hydraulic Oil Filter Metal End Cap Element with synthetic media
YUCHAI 820-8514200



H 1 : 105.5 (mm)
H 2 : 102 (mm)
OD 1 : 50 (mm)
OD 2 : 50 (mm)
ID 1 : 18 (mm)

CONT : 12
VOL : 0.008

H-4101 Hydraulic Oil Filter Plastic Element With Glass Fiber Media
KOBELCO YN52V01011P1



H 1 : 249 (mm)
H 2 : 231 (mm)
OD 1 : 144 (mm)
OD 2 : 142.5 (mm)
ID 1 : 96.5 (mm)
ID 2 : 96.5 (mm)
Thread Size : 4 7/16"X11 G

CONT : 12
VOL : 0.082

Note : With packing set version uses H-41013

H-28050 Hydraulic Oil Filter Metal End Cap Element with synthetic media
HYUNDAI 31MH-01310



H 1 : 226 (mm)
OD 1 : 120 (mm)
OD 2 : 120 (mm)
ID 1 : 76 (mm)
ID 2 : 76 (mm)

CONT : 6
VOL : 0.027

H-38020 Hydraulic Oil Filter Metal End Cap Element with synthetic media
GUANGXI LIUGONG MACHINERY 53C0005
GUANGXI LIUGONG MACHINERY 53C0008



H 1 : 555 (mm)
H 2 : 550 (mm)
OD 1 : 120 (mm)
OD 2 : 120 (mm)
ID 1 : 79 (mm)
ID 2 : 81.5 (mm)

CONT : 1
VOL : 0.010

H-41012 Hydraulic Oil Filter Aluminium Casting Element
KOBELCO YN52-V0101 1P1



H 1 : 251.5 (mm)
H 2 : 232 (mm)
OD 1 : 145 (mm)
OD 2 : 145 (mm)
ID 1 : 96.5 (mm)
ID 2 : 96.5 (mm)
Thread Size : 4 7/16"X11 G

CONT : 12
VOL : 0.082



Technical Specification

H-41013 Hydraulic Oil Filter Plastic Element with synthetic media

KOBELCO YN52V01011P1
KOBELCO YN52V01016R100
KOBELCO YN52V01016R600



H 1 : 249 (mm)
H 2 : 231 (mm)
OD 1 : 142.5 (mm)
OD 2 : 142.5 (mm)
ID 1 : 97 (mm)
ID 2 : 97 (mm)
Thread Size : 4 7/16"X11G

CONT : 12
VOL : 0.082

Note : Without packing set version uses H-4101

H-41090 Hydraulic Oil Filter Metal End Cap Element

DOOSAN 15265318



H 1 : 207 (mm)
OD 1 : 152.5 (mm)
OD 2 : 152.5 (mm)
ID 1 : 104 (mm)
ID 2 : 104 (mm)

CONT : 6
VOL : 0.039

H-42150 Hydraulic Oil Filter Metal End Cap Element with synthetic media

LONKING LG50F-100012-H



H 1 : 500 (mm)
OD 1 : 97.7 (mm)
OD 2 : 150 (mm)
ID 1 : 86 (mm)
ID 2 : 87.5 (mm)

CONT : 1
VOL : 0.014

H-4102 Hydraulic Oil Filter Metal End Cap Element

KOBELCO 2446U2335-2
KOBELCO R36N0007
KOBELCO R36P002



H 1 : 228 (mm)
OD 1 : 150 (mm)
OD 2 : 150 (mm)
ID 1 : 110 (mm)
ID 2 : 110 (mm)

CONT : 10
VOL : 0.083

H-42020 Hydraulic Oil Filter Metal End Cap Element

CLARK 4303429



H 1 : 202 (mm)
H 2 : 195 (mm)
OD 1 : 93 (mm)
OD 2 : 93 (mm)
ID 1 : 47 (mm)

CONT : 25
VOL : 0.065

H-42160 Hydraulic Oil Filter Metal End Cap Element

XGMA 60C0011



H 1 : 470 (mm)
H 2 : 465 (mm)
OD 1 : 77 (mm)
OD 2 : 136 (mm)
ID 1 : 67.8 (mm)
ID 2 : 86 (mm)

CONT : 1
VOL : 0.010

H-41030 Hydraulic Oil Filter Metal End Cap Element

KOBELCO ZD12G19000



H 1 : 449 (mm)
OD 1 : 112 (mm)
OD 2 : 112 (mm)
ID 1 : 70 (mm)
ID 2 : 70 (mm)

CONT : 10
VOL : 0.077

H-42110 Hydraulic Oil Filter Wire Mesh supported Element

F.B.O CM18003



H 1 : 177 (mm)
H 2 : 173.5 (mm)
OD 1 : 42.5 (mm)
OD 2 : 42.5 (mm)
ID 1 : 21.5 (mm)

CONT : 50
VOL : 0.022

H-42170 Hydraulic Oil Filter Metal End Cap Element with synthetic media

YUCHAI 8530-0503201



H 1 : 340 (mm)
OD 1 : 150 (mm)
OD 2 : 150 (mm)
ID 1 : 110 (mm)

CONT : 6
VOL : 0.061

H-41060 Hydraulic Oil Filter Element With Glass Fiber Media

KOBELCO PW52V01001R100
KOBELCO PW52V01002P1



H 1 : 110.5 (mm)
H 2 : 109.5 (mm)
OD 1 : 82 (mm)
OD 2 : 82 (mm)
ID 1 : 41 (mm)
ID 2 : 41 (mm)

CONT : 50
VOL : 0.048

H-42120 Hydraulic Oil Filter Metal End Cap Element



H 1 : 505 (mm)
H 2 : 500 (mm)
OD 1 : 150 (mm)
OD 2 : 150 (mm)
ID 1 : 85 (mm)
ID 2 : 87.5 (mm)

CONT : 1
VOL : 0.014

H-42180 Hydraulic Oil Filter Metal End Cap Element

SANY B222100000346



H 1 : 384.5 (mm)
H 2 : 378 (mm)
OD 1 : 200 (mm)
OD 2 : 200 (mm)
ID 1 : 112.8 (mm)
ID 2 : 115 (mm)

CONT : 1
VOL : 0.019

H-41080 Hydraulic Oil Filter Element

KOBELCO YR50V00004P1



H 1 : 449 (mm)
OD 1 : 112 (mm)
OD 2 : 112 (mm)
ID 1 : 70 (mm)
ID 2 : 70 (mm)

CONT : 6
VOL : 0.042

H-42140 Hydraulic Oil Filter Metal End Cap Element

XGMA 60C0010



H 1 : 585 (mm)
H 2 : 560 (mm)
OD 1 : 136 (mm)
OD 2 : 136 (mm)
ID 1 : 67.8 (mm)

CONT : 1
VOL : 0.014

H-42190 Hydraulic Oil Filter Metal End Cap Element with synthetic media

LEE MIN TLX235L



H 1 : 501 (mm)
H 2 : 497 (mm)
OD 1 : 130 (mm)
OD 2 : 150 (mm)
ID 1 : 110 (mm)
ID 2 : 112 (mm)

CONT : 1
VOL : 0.014



Technical Specification

H-42230 Hydraulic Oil Filter Metal End Cap Element
SOFIMA 730403000197



H 1 : 135.2 (mm)
H 2 : 128 (mm)
OD 1 : 150 (mm)
OD 2 : 150 (mm)
ID 1 : 87 (mm)
Thread Size : M10X1.5

CONT : 12
VOL : 0.053

Note : for Sunward Excavator

H-45020 Hydraulic Oil Filter Metal End Cap Element with synthetic media
CASE 159705A1



H 1 : 202.5 (mm)
H 2 : 198 (mm)
OD 1 : 82.5 (mm)
OD 2 : 82 (mm)
ID 1 : 44 (mm)

CONT : 12
VOL : 0.022

H-48370 Hydraulic Oil Filter Metal End Cap Element



H 1 : 195 (mm)
OD 1 : 118 (mm)
OD 2 : 118 (mm)
ID 1 : 88 (mm)
ID 2 : 88 (mm)

CONT : 9
VOL : 0.035

Note : special product

H-42240 Hydraulic Oil Filter Metal End Cap Element with synthetic media
LEE MIN TLX368C



H 1 : 398 (mm)
H 2 : 384 (mm)
OD 1 : 90 (mm)
OD 2 : 90 (mm)
ID 1 : 49 (mm)
ID 2 : 46.6 (mm)

CONT : 6
VOL : 0.029

H-45030 Hydraulic Oil Filter Metal End Cap Element
NEW HOLLAND (CNH) 51333203
NEW HOLLAND (CNH) K51333203



H 1 : 175 (mm)
OD 1 : 101 (mm)
OD 2 : 101 (mm)
ID 1 : 40 (mm)
ID 2 : 13 (mm)

CONT : 25
VOL : 0.057

H-4902 Hydraulic Oil Filter Element
HYDAC 1251201



H 1 : 312 (mm)
H 2 : 297 (mm)
OD 1 : 89 (mm)
OD 2 : 86 (mm)
Thread Size : 2"X11 BSP

CONT : 12
VOL : 0.038

H-42250 Hydraulic Oil Filter Metal End Cap Element with synthetic media
SANY 60029588



H 1 : 121.5 (mm)
H 2 : 117 (mm)
OD 1 : 53 (mm)
OD 2 : 53 (mm)
ID 1 : 19 (mm)

CONT : 12
VOL : 0.010

H-45040 Hydraulic Oil Filter Element
NEW HOLLAND (CNH) PU50V00001P2



H 1 : 165 (mm)
H 2 : 124.5 (mm)
OD 1 : 68 (mm)
OD 2 : 68 (mm)

CONT : 25
VOL : 0.029

H-4903 Hydraulic Oil Filter Element
HYDAC 1251197
YANMAR 172484-73730
KUBOTA 69481-62210
UCCHYDR UCSE1323



H 1 : 210.5 (mm)
H 2 : 195.5 (mm)
OD 1 : 87 (mm)
OD 2 : 86 (mm)
Thread Size : 1 1/2"X11 BSP

CONT : 16
VOL : 0.034

H-42260 Hydraulic Oil Filter Metal End Cap Element
HYDAC 02060879
HYDAC 10616D25BN
TRIBOGUARD 83001625UM
PALL HC8300FDT16Z
PALL HC8300FKT16H



H 1 : 426 (mm)
OD 1 : 152.5 (mm)
OD 2 : 152.5 (mm)
ID 1 : 104 (mm)
ID 2 : 104 (mm)

CONT : 1
VOL : 0.012

H-45050 Hydraulic Oil Filter Metal End Cap Element
HUERLIMANN TRAKTOREN 0.900.1261.4
KHD(KLOCKNER-HUMBOLT-DEUTZ) 0.900.1261.4
CASE-IH CNH 47522804
NEW HOLLAND (CNH) 84409205



H 1 : 200.5 (mm)
H 2 : 195 (mm)
OD 1 : 70 (mm)
OD 2 : 70 (mm)
ID 1 : 25.5 (mm)

CONT : 50
VOL : 0.013

H-4904 Hydraulic Oil Filter Metal End Cap Element Cellulose media
SCHAEFF 5003599910
ARGO P2.0923.01



H 1 : 227 (mm)
OD 1 : 83 (mm)
OD 2 : 83 (mm)
ID 1 : 50 (mm)
ID 2 : 50 (mm)

CONT : 9
VOL : 0.021

H-43010 Hydraulic Oil Filter Metal End Cap Element
J.C.BAMFORD JSJ 0075



H 1 : 330 (mm)
OD 1 : 178 (mm)
OD 2 : 178 (mm)
ID 1 : 110 (mm)
ID 2 : 110 (mm)

CONT : 1
VOL : 0.012

H-48320 Hydraulic Oil Filter Metal End Cap Element with synthetic media
NEW HOLLAND (CNH) 72111326
TAMROCK 86727289



H 1 : 580 (mm)
OD 1 : 126 (mm)
OD 2 : 126 (mm)
ID 1 : 91.6 (mm)
ID 2 : 10 (mm)

CONT : 1
VOL : 0.013

H-4905 Hydraulic Oil Filter Element
KUBOTA RD 401-62150

















H 1 : 213 (mm)
H 2 : 183 (mm)
OD 1 : 90 (mm)
OD 2 : 90 (mm)
ID 1 : 25.7 (mm)
Thread Size : 1 1/4X13 BSPT

CONT : 25
VOL : 0.065

















Technical Specification

<p>H-5001</p> <p>Hydraulic Oil Filter Metal End Cap Element With Glass Fiber Media</p> <p>TAMROCK 81893749 FORD E8NNF882BA PALL HC9600FUS8H</p>  <p>H 1 : 208 (mm) H 2 : 204 (mm) OD 1 : 79 (mm) OD 2 : 79 (mm) ID 1 : 42 (mm)</p> <p>CONT : 25 VOL : 0.040</p>	<p>H-5107</p> <p>Hydraulic Oil Filter Element With Glass Fiber Media</p> <p>VOLVO 11707544 J.C.BAMFORD 32/917701 J.C.BAMFORD 6900/0084</p>  <p>H 1 : 112 (mm) H 2 : 108 (mm) OD 1 : 51 (mm) OD 2 : 51 (mm) ID 1 : 23 (mm)</p> <p>CONT : 50 VOL : 0.022</p>	<p>H-51150</p> <p>Hydraulic Oil Filter Element</p> <p>MANITOU 236094</p>  <p>H 1 : 243.6 (mm) H 2 : 236.7 (mm) OD 1 : 69 (mm) OD 2 : 69.5 (mm) ID 1 : 28.3 (mm)</p> <p>CONT : 25 VOL : 0.035</p>
<p>H-5101</p> <p>Hydraulic Oil Filter Wire Mesh supported Element</p> <p>MASSEY-FERGUSON 3530223M92 MASSEY-FERGUSON 35630223M92</p>  <p>H 1 : 181 (mm) H 2 : 155 (mm) OD 1 : 80 (mm) OD 2 : 80 (mm) ID 1 : 28 (mm)</p> <p>CONT : 25 VOL : 0.038</p>	<p>H-5109</p> <p>Hydraulic Oil Filter Transmission Metal End Cap Element</p> <p>MASSEY-FERGUSON 1023057M1 CLARK 230962 JOHN DEERE AT49249 FORD D3NN7C045A CASE D52932</p>  <p>H 1 : 143.3 (mm) H 2 : 140 (mm) OD 1 : 88 (mm) OD 2 : 88 (mm) ID 1 : 29 (mm)</p> <p>CONT : 12 VOL : 0.020</p>	<p>H-51160</p> <p>Hydraulic Oil Filter Element</p> <p>MANITOU 563483</p>  <p>H 1 : 178 (mm) H 2 : 171 (mm) OD 1 : 69 (mm) OD 2 : 69 (mm) ID 1 : 29 (mm)</p> <p>CONT : 50 VOL : 0.051</p>
<p>H-5102</p> <p>Hydraulic Oil Filter Metal End Cap Element</p> <p>MASSEY-FERGUSON 1870199M92 MASSEY-FERGUSON MF185</p>  <p>H 1 : 88.5 (mm) H 2 : 86.5 (mm) OD 1 : 62 (mm) OD 2 : 62 (mm) ID 1 : 40.5 (mm) ID 2 : 12.5 (mm)</p> <p>CONT : 50 VOL : 0.025</p>	<p>H-51120</p> <p>Hydraulic Oil Filter Element</p> <p>MANITOU 686236</p>  <p>H 1 : 213 (mm) OD 1 : 63 (mm) OD 2 : 63 (mm) ID 1 : 27.3 (mm)</p> <p>CONT : 25 VOL : 0.034</p>	<p>H-51170</p> <p>Hydraulic Oil Filter Element</p> <p>MASSEY-FERGUSON 516069-M94</p>  <p>H 1 : 181 (mm) H 2 : 176 (mm) OD 1 : 114 (mm) OD 2 : 114 (mm) ID 1 : 44.5 (mm)</p> <p>CONT : 25 VOL : 0.071</p>
<p>H-5103</p> <p>Hydraulic Oil Filter Metal End Cap Element</p> <p>J.C.BAMFORD 32/901200</p>  <p>H 1 : 236 (mm) OD 1 : 174 (mm) OD 2 : 174 (mm) ID 1 : 93.5 (mm) ID 2 : 93.5 (mm)</p> <p>CONT : 1 VOL : 0.009</p>	<p>H-51130</p> <p>Hydraulic Oil Filter Element</p> <p>MANITOU 602096</p>  <p>H 1 : 328 (mm) OD 1 : 88 (mm) OD 2 : 88 (mm) ID 1 : 39 (mm) ID 2 : 39 (mm)</p> <p>CONT : 15 VOL : 0.060</p>	<p>H-51180</p> <p>Hydraulic Oil Filter Element</p> <p>MANITOU 820437</p>  <p>H 1 : 134 (mm) H 2 : 116 (mm) OD 1 : 99 (mm) OD 2 : 99 (mm) Thread Size : 1 3/8X11 BSPT</p> <p>CONT : 12 VOL : 0.028</p>
<p>H-51050</p> <p>Hydraulic Oil Filter Metal End Cap Element</p> <p>ATLAS WEYHAUSEN 1713844 ATLAS 3607792 ATLAS 4653916 J.C.BAMFORD 581/00012</p>  <p>H 1 : 300 (mm) OD 1 : 72 (mm) OD 2 : 72 (mm) ID 1 : 45 (mm) ID 2 : 7.5 (mm)</p> <p>CONT : 25 VOL : 0.049</p> <p>Note : H-7973 (Media difference)</p>	<p>H-51140</p> <p>Hydraulic Oil Filter Element</p> <p>MANITOU 236095</p>  <p>H 1 : 178 (mm) H 2 : 172 (mm) OD 1 : 69 (mm) OD 2 : 69.5 (mm) ID 1 : 28.3 (mm)</p> <p>CONT : 36 VOL : 0.037</p>	<p>H-51190</p> <p>Hydraulic Oil Filter Element</p> <p>MANITOU 513752</p>  <p>H 1 : 223 (mm) H 2 : 205 (mm) OD 1 : 99 (mm) OD 2 : 99 (mm) Thread Size : 2X11 BSP</p> <p>CONT : 4 VOL : 0.015</p>



Technical Specification

<p>H-51200 Hydraulic Oil Filter Element</p> <p>MANITOU 77402</p>  <p>H 1 : 269 (mm) H 2 : 254 (mm) OD 1 : 86 (mm) OD 2 : 82 (mm)</p> <p>CONT : 25 VOL : 0.077</p>	<p>H-5203 Hydraulic Oil Filter Wire Mesh supported Element</p> <p>YANMAR 172112-74801</p>  <p>H 1 : 98.5 (mm) H 2 : 90 (mm) OD 1 : 124 (mm) OD 2 : 124 (mm) ID 1 : 59.5 (mm) Thread Size : M10X1.5</p> <p>CONT : 20 VOL : 0.043</p>	<p>H-5208 Hydraulic Oil Filter Wire Mesh supported Element</p> <p>HITACHI 24464119 KOBELCO 2446R116E1</p>  <p>H 1 : 198 (mm) H 2 : 190 (mm) OD 1 : 150 (mm) OD 2 : 150 (mm) ID 1 : 96.6 (mm) Thread Size : M10X1.5</p> <p>CONT : 9 VOL : 0.060</p>
<p>H-51210 Hydraulic Oil Filter Element</p> <p>MANITOU 224726</p>  <p>H 1 : 259 (mm) H 2 : 244 (mm) OD 1 : 86 (mm) OD 2 : 82 (mm) Thread Size : 2"X11 BSP</p> <p>CONT : 25 VOL : 0.073</p>	<p>H-5204 Hydraulic Oil Filter Wire Mesh supported Element</p> <p>YANMAR 172137-73700</p>  <p>H 1 : 91.4 (mm) H 2 : 83 (mm) OD 1 : 100 (mm) OD 2 : 100 (mm) ID 1 : 45.6 (mm) Thread Size : M10X1.5</p> <p>CONT : 50 VOL : 0.054</p>	<p>H-52090 Hydraulic Oil Filter Metal End Cap Element with synthetic media</p> <p>YANMAR 172486-73710</p>  <p>H 1 : 240 (mm) OD 1 : 89 (mm) OD 2 : 89 (mm) ID 1 : 58 (mm) ID 2 : 58 (mm)</p> <p>CONT : 12 VOL : 0.032</p>
<p>H-51220 Hydraulic Oil Filter Metal End Cap Element</p> <p>MANITOU 21967 MANITOU 221174</p>  <p>H 1 : 199.5 (mm) H 2 : 193.5 (mm) OD 1 : 70 (mm) OD 2 : 70 (mm) ID 1 : 42 (mm)</p> <p>CONT : 25 VOL : 0.042</p>	<p>H-52050 Hydraulic Oil Filter Metal End Cap Element with synthetic media</p> <p>YANMAR 151103700T YAMASHIN 15511-03700T YANMAR 1551103700T</p>  <p>H 1 : 280 (mm) OD 1 : 106.7 (mm) OD 2 : 106.7 (mm) Thread Size : PT1</p> <p>CONT : 12 VOL : 0.054</p>	<p>H-5211 Hydraulic Oil Filter Wire Mesh supported Element</p> <p>HYUNDAI 31E9-0018 KOBELCO R36P0019</p>  <p>H 1 : 87 (mm) H 2 : 83.5 (mm) OD 1 : 42.5 (mm) OD 2 : 42.5 (mm) ID 1 : 21.5 (mm)</p> <p>CONT : 50 VOL : 0.017</p>
<p>H-51230 Hydraulic Oil Filter Metal End Cap Element</p> <p>MANITOU 899154</p>  <p>H 1 : 155 (mm) H 2 : 137 (mm) OD 1 : 99 (mm) OD 2 : 99 (mm)</p> <p>CONT : 25 VOL : 0.051</p>	<p>H-5206 Hydraulic Oil Filter Wire Mesh supported Element</p> <p>HITACHI 4857186 HITACHI 573330 HITACHI 673330</p>  <p>H 1 : 95.5 (mm) H 2 : 89 (mm) OD 1 : 150 (mm) OD 2 : 150 (mm) ID 1 : 73.4 (mm) Thread Size : M10X1.5</p> <p>CONT : 9 VOL : 0.033</p>	<p>H-52130 Hydraulic Oil Filter Return Plastic Element</p> <p>YANMAR 172A59-73770</p>  <p>H 1 : 198.5 (mm) H 2 : 153 (mm) OD 1 : 78 (mm) OD 2 : 78 (mm) Thread Size : 3/4"X14 BSP</p> <p>CONT : 25 VOL : 0.046</p>
<p>H-5202 Hydraulic Oil Filter Element</p> <p>TAKEUCHI 15511-00700 YANMAR 15511-00700 TAKEUCHI 15511-03300 YANMAR 172112-74911</p>  <p>H 1 : 223 (mm) H 2 : 219 (mm) OD 1 : 112 (mm) OD 2 : 112 (mm) ID 1 : 70 (mm) ID 2 : 70 (mm)</p> <p>CONT : 10 VOL : 0.024</p>	<p>H-52070 Hydraulic Oil Filter Metal End Cap Element</p> <p>YANMAR 172448-73780</p>  <p>H 1 : 186 (mm) H 2 : 150 (mm) OD 1 : 74.5 (mm) OD 2 : 74 (mm) Thread Size : 3/4"X14 BSPT</p> <p>CONT : 50 VOL : 0.080</p>	<p>H-52140 Hydraulic Oil Filter Metal End Cap Element</p> <p>YANMAR 172B11-73760</p>  <p>H 1 : 142 (mm) H 2 : 134 (mm) OD 1 : 42.5 (mm) OD 2 : 42.5 (mm) ID 1 : 21.5 (mm)</p> <p>CONT : 50 VOL : 0.018</p>



Technical Specification

H-52150 Hydraulic Oil Filter Return Plastic Element
YANMAR 172194-73730



H 1 : 210.5 (mm)
H 2 : 195.5 (mm)
OD 1 : 87 (mm)
OD 2 : 87 (mm)

CONT : 16
VOL : 0.034

H-53010 Hydraulic Oil Filter Transmission Metal End Cap Element Synthetic Media
VOLVO 11992372
ALLISON 23040988
GENERAL MOTORS 23040988



H 1 : 208.3 (mm)
H 2 : 204 (mm)
OD 1 : 76.5 (mm)
OD 2 : 76.5 (mm)
ID 1 : 38 (mm)

CONT : 12
VOL : 0.021

H-5407 Hydraulic Oil Filter Metal End Cap Element
MC CORMICK (LANDINI-ARGO) 3139076R92



H 1 : 116.8 (mm)
H 2 : 112 (mm)
OD 1 : 56.3 (mm)
OD 2 : 56.3 (mm)
ID 1 : 24.5 (mm)

CONT : 50
VOL : 0.052

H-5217 Hydraulic Oil Filter Element
YANMAR 172146-73730



H 1 : 185 (mm)
H 2 : 169 (mm)
OD 1 : 88 (mm)
OD 2 : 86 (mm)
Thread Size : 1 1/2"X11 BSPT

CONT : 25
VOL : 0.045

H-5401 Hydraulic Oil Filter Metal End Cap Element
INTERNATIONAL HARVESTER 075511806



H 1 : 293 (mm)
OD 1 : 110 (mm)
OD 2 : 110 (mm)
ID 1 : 70 (mm)
ID 2 : 70 (mm)

CONT : 12
VOL : 0.061

H-5408 Hydraulic Oil Filter Element With Glass Fiber Media
CASE 3224623R1
MC CORMICK (LANDINI-ARGO) 3224623R1
RENAULT 60 05 019 565



H 1 : 70.8 (mm)
H 2 : 66 (mm)
OD 1 : 56.3 (mm)
OD 2 : 56.3 (mm)
ID 1 : 24.5 (mm)
ID 2 : 10 (mm)

CONT : 50
VOL : 0.016

H-52180 Hydraulic Oil Filter Element
YANMAR 172482-73730



H 1 : 184.5 (mm)
H 2 : 169.5 (mm)
OD 1 : 87 (mm)
OD 2 : 87 (mm)
ID 1 : 69 (mm)
Thread Size : 1 1/2X11 BSP

CONT : 25
VOL : 0.044

H-5403 Hydraulic Oil Filter Metal End Cap Element
INTERNATIONAL HARVESTER 1140079 C1



H 1 : 231 (mm)
H 2 : 229 (mm)
OD 1 : 114 (mm)
OD 2 : 114 (mm)
ID 1 : 58.5 (mm)
ID 2 : 58.5 (mm)

CONT : 20
VOL : 0.074

H-5409 Hydraulic Oil Filter Wire Mesh supported Element With Glass Fiber Media
CASE 1328276C1



H 1 : 116.8 (mm)
H 2 : 112 (mm)
OD 1 : 56.3 (mm)
OD 2 : 56.3 (mm)
ID 1 : 24.5 (mm)

CONT : 25
VOL : 0.014

H-52190 Hydraulic Oil Filter Metal End Cap Element
DOOSAN 474-00046



H 1 : 228 (mm)
H 2 : 224 (mm)
OD 1 : 60 (mm)
OD 2 : 60 (mm)
ID 1 : 33 (mm)

CONT : 25
VOL : 0.038

H-5405 Hydraulic Oil Filter Metal End Cap Element
INTERNATIONAL HARVESTER 381256 R91
INTERNATIONAL HARVESTER 381258R92



H 1 : 180.7 (mm)
H 2 : 179 (mm)
OD 1 : 114 (mm)
OD 2 : 114 (mm)
ID 1 : 58.5 (mm)
ID 2 : 15 (mm)

CONT : 10
VOL : 0.031

H-5410 Hydraulic Oil Filter Metal End Cap Element
CASE 133736C1
CASE 401073R2
INTERNATIONAL HARVESTER 401073R2



H 1 : 77 (mm)
H 2 : 76 (mm)
OD 1 : 126.7 (mm)
OD 2 : 126.7 (mm)
ID 1 : 75.7 (mm)
ID 2 : 75.7 (mm)

CONT : 30
VOL : 0.059

H-52200 Hydraulic Oil Filter Metal End Cap Element with synthetic media
DOOSAN 474-00056



H 1 : 450 (mm)
OD 1 : 178 (mm)
OD 2 : 178 (mm)
ID 1 : 110 (mm)
ID 2 : 110 (mm)

CONT : 6
VOL : 0.114

H-5406 Hydraulic Oil Filter Metal End Cap Element
INTERNATIONAL HARVESTER 631144 C1
INTERNATIONAL HARVESTER 631144 C2



H 1 : 228 (mm)
OD 1 : 114 (mm)
OD 2 : 114 (mm)
ID 1 : 58.5 (mm)
ID 2 : 13.5 (mm)

CONT : 20
VOL : 0.074

H-5501 Hydraulic Oil Filter Metal End Cap Element
CATERPILLAR 1R-0730
CATERPILLAR 2P-5834



H 1 : 144 (mm)
OD 1 : 77 (mm)
OD 2 : 77 (mm)
ID 1 : 26 (mm)

CONT : 25
VOL : 0.033



Technical Specification

H-5502 Hydraulic Oil Filter Metal End Cap Element Cellulose media

CATERPILLAR 1R-0728
CATERPILLAR 4J-0816



H 1 : 228 (mm)
OD 1 : 79 (mm)
OD 2 : 79 (mm)
ID 1 : 47.5 (mm)
ID 2 : 47.5 (mm)

CONT : 25
VOL : 0.048

Note : Performance grade uses H-5508

H-5507 Hydraulic Oil Filter Wire Mesh supported Element

CATERPILLAR 3S-3865
CATERPILLAR 3S-3875
CATERPILLAR 3S-3875X



H 1 : 230 (mm)
OD 1 : 85.6 (mm)
OD 2 : 85.6 (mm)
ID 1 : 45.8 (mm)

CONT : 25
VOL : 0.066

H-5513 Hydraulic Oil Filter Metal End Cap Element

HUPPENKOTHEN BAUMASCHINEN
1551200601T
CATERPILLAR 997352
CASE KHJ 1493



H 1 : 79 (mm)
H 2 : 75 (mm)
OD 1 : 51 (mm)
OD 2 : 53 (mm)
ID 1 : 23 (mm)

CONT : 50
VOL : 0.016

H-5503 Hydraulic Oil Filter Metal End Cap Element

CATERPILLAR 1R-0720
CATERPILLAR 4J-6064



H 1 : 228 (mm)
OD 1 : 130 (mm)
OD 2 : 130 (mm)
ID 1 : 84.4 (mm)
ID 2 : 84.4 (mm)

CONT : 20
VOL : 0.105

Note : Performance grade uses H-5526

H-5508 Hydraulic Oil Filter Metal End Cap Element With Glass Fiber Media

CATERPILLAR 139-1532
CATERPILLAR 4J-0816
CATERPILLAR 4T-3130



H 1 : 228 (mm)
OD 1 : 79 (mm)
OD 2 : 79 (mm)
ID 1 : 47.5 (mm)
ID 2 : 47.5 (mm)

CONT : 25
VOL : 0.059

H-5514 Hydraulic Oil Filter Metal End Cap Element

MITSUBISHI SV-90



H 1 : 300.5 (mm)
OD 1 : 150 (mm)
OD 2 : 150 (mm)
ID 1 : 110 (mm)
ID 2 : 110 (mm)

CONT : 10
VOL : 0.970

H-5504 Hydraulic Oil Filter Metal End Cap Element

CATERPILLAR 1R-0719
CATERPILLAR 2M-3943
CATERPILLAR 9M-9740



H 1 : 234 (mm)
OD 1 : 101 (mm)
OD 2 : 101 (mm)
ID 1 : 59 (mm)
ID 2 : 59 (mm)

CONT : 20
VOL : 0.071

H-5509 Hydraulic Oil Filter Metal End Cap Element

CATERPILLAR 7J-0670
CATERPILLAR 7J-670



H 1 : 229 (mm)
OD 1 : 173 (mm)
OD 2 : 173 (mm)
ID 1 : 100 (mm)
ID 2 : 100 (mm)

CONT : 9
VOL : 0.083

H-5515 Hydraulic Oil Filter Metal End Cap Element

KOBELCO 24046Z12



H 1 : 304.8 (mm)
OD 1 : 112 (mm)
OD 2 : 112 (mm)
ID 1 : 70 (mm)
ID 2 : 70 (mm)

CONT : 10
VOL : 0.137

H-5505 Hydraulic Oil Filter Metal End Cap Element

CATERPILLAR 094-4412
HITACHI 4219713



H 1 : 455 (mm)
H 2 : 450 (mm)
OD 1 : 150 (mm)
OD 2 : 150 (mm)
ID 1 : 110 (mm)
ID 2 : 110 (mm)

CONT : 6
VOL : 0.080

Note : With outer packing 1 pc

H-5510 Hydraulic Oil Filter Metal End Cap Element

CATERPILLAR 1R-0735
CATERPILLAR 4T-0522
CATERPILLAR 4T-0523



H 1 : 177.5 (mm)
OD 1 : 130 (mm)
OD 2 : 130 (mm)
ID 1 : 84.4 (mm)
ID 2 : 84.4 (mm)

CONT : 20
VOL : 0.083

H-5516 Hydraulic Oil Filter Suction Wire Mesh supported Element

CATERPILLAR 4S-8598



H 1 : 154 (mm)
OD 1 : 85.5 (mm)
OD 2 : 85.5 (mm)
ID 1 : 59 (mm)
ID 2 : 45.8 (mm)

CONT : 50
VOL : 0.074

H-5506 Hydraulic Oil Filter Metal End Cap Element with synthetic media

CATERPILLAR 1R-0722
CATERPILLAR 9J-0750
CATERPILLAR 9J-5461



H 1 : 278 (mm)
OD 1 : 130 (mm)
OD 2 : 130 (mm)
ID 1 : 84.4 (mm)
ID 2 : 84.4 (mm)

CONT : 15
VOL : 0.093

H-5512 Hydraulic Oil Filter Wire Mesh supported Element

CATERPILLAR 31E5-4026



H 1 : 136 (mm)
H 2 : 129 (mm)
OD 1 : 150 (mm)
OD 2 : 150 (mm)
ID 1 : 112.8 (mm)
Thread Size : M10X1.25

CONT : 18
VOL : 0.078

H-5517 Hydraulic Oil Filter Metal End Cap Element

MASSEY-FERGUSON 1495479M1

















H 1 : 230 (mm)
OD 1 : 99 (mm)
OD 2 : 99 (mm)
ID 1 : 41 (mm)
ID 2 : 41 (mm)

CONT : 20
VOL : 0.076

















Technical Specification

<p>H-5518</p> <p>Hydraulic Oil Filter Metal End Cap Element With Glass Fiber Media</p> <p>SUMITOMO KRJ 3547</p>  <p>H 1 : 202.5 (mm) H 2 : 198.5 (mm) OD 1 : 79 (mm) OD 2 : 79 (mm) ID 1 : 41.8 (mm)</p> <p>CONT : 25 VOL : 0.054</p>	<p>H-5525</p> <p>Hydraulic Oil Filter Metal End Cap Element</p> <p>CATERPILLAR 120-8757</p>  <p>H 1 : 229 (mm) OD 1 : 100 (mm) OD 2 : 100 (mm) ID 1 : 60 (mm) ID 2 : 60 (mm)</p> <p>CONT : 25 VOL : 0.074</p>	<p>H-55310</p> <p>Hydraulic Oil Filter Metal End Cap Element</p> <p>CATERPILLAR 3I-1728</p>  <p>H 1 : 197.5 (mm) H 2 : 188 (mm) OD 1 : 91.5 (mm) OD 2 : 91.5 (mm) ID 1 : 47 (mm)</p> <p>CONT : 12 VOL : 0.029</p>
<p>H-5519</p> <p>Hydraulic Oil Filter Metal End Cap Element</p> <p>SUMITOMO KRJ 1599</p>  <p>H 1 : 291 (mm) OD 1 : 112 (mm) OD 2 : 112 (mm) ID 1 : 70 (mm) ID 2 : 70 (mm)</p> <p>CONT : 9 VOL : 0.049</p>	<p>H-55251</p> <p>Hydraulic Oil Filter Metal End Cap Element With Glass Fiber Media</p> <p>CATERPILLAR 304-7195</p>  <p>H 1 : 229 (mm) OD 1 : 100 (mm) OD 2 : 100 (mm) ID 1 : 60 (mm) ID 2 : 60 (mm)</p> <p>CONT : 25 VOL : 0.074</p>	<p>H-55320</p> <p>Hydraulic Oil Filter Metal End Cap Element with synthetic media</p> <p>CATERPILLAR 3I-0589</p>  <p>H 1 : 231.9 (mm) OD 1 : 101 (mm) OD 2 : 101 (mm) ID 1 : 58 (mm) ID 2 : 58 (mm)</p> <p>CONT : 12 VOL : 0.045</p>
<p>H-5520</p> <p>Hydraulic Oil Filter Metal End Cap Element</p> <p>CATERPILLAR 265-8676</p>  <p>H 1 : 230 (mm) OD 1 : 82 (mm) OD 2 : 82 (mm) ID 1 : 41 (mm) ID 2 : 41 (mm)</p> <p>CONT : 12 VOL : 0.056</p>	<p>H-5526</p> <p>Hydraulic Oil Filter Metal End Cap Element With Glass Fiber Media</p> <p>CATERPILLAR 132-8876 CATERPILLAR 4J-6064 CATERPILLAR 9W-6428</p>  <p>H 1 : 228 (mm) OD 1 : 130 (mm) OD 2 : 130 (mm) ID 1 : 85 (mm) ID 2 : 85 (mm)</p> <p>CONT : 12 VOL : 0.062</p>	<p>H-55330</p> <p>Hydraulic Oil Filter Metal End Cap Element With Glass Fiber Media</p> <p>CATERPILLAR 109-7293 LIEBHERR 7362910</p>  <p>H 1 : 94.5 (mm) H 2 : 92 (mm) OD 1 : 35 (mm) OD 2 : 35 (mm) ID 1 : 11.5 (mm)</p> <p>CONT : 100 VOL : 0.019</p>
<p>H-55201</p> <p>Hydraulic Oil Filter Metal End Cap Element With Glass Fiber Media</p> <p>CATERPILLAR 265-8676</p>  <p>H 1 : 230 (mm) OD 1 : 82 (mm) OD 2 : 82 (mm) ID 1 : 41 (mm) ID 2 : 41 (mm)</p> <p>CONT : 25 VOL : 0.060</p>	<p>H-55270</p> <p>Hydraulic Oil Filter Metal End Cap Element with synthetic media</p> <p>CATERPILLAR 132-8875 CATERPILLAR 4T-3131</p>  <p>H 1 : 231 (mm) OD 1 : 101 (mm) OD 2 : 101 (mm) ID 1 : 59 (mm) ID 2 : 59 (mm)</p> <p>CONT : 12 VOL : 0.045</p>	<p>H-55331</p> <p>Hydraulic Oil Filter Metal End Cap Element With Glass Fiber Media</p> <p>VOLVO 11988322 LIEBHERR 570584808</p>  <p>H 1 : 92.5 (mm) H 2 : 90 (mm) OD 1 : 35 (mm) OD 2 : 35 (mm) ID 1 : 11.5 (mm)</p> <p>CONT : 100 VOL : 0.019</p>
<p>H-5522</p> <p>Hydraulic Oil Filter Element With Glass Fiber Media</p> <p>CATERPILLAR 179-9806</p>  <p>H 1 : 425 (mm) H 2 : 416.6 (mm) OD 1 : 142 (mm) OD 2 : 142 (mm) ID 1 : 97.2 (mm) ID 2 : 97.2 (mm)</p> <p>CONT : 4 VOL : 0.047</p>	<p>H-55280</p> <p>Hydraulic Oil Filter Metal End Cap Element with synthetic media</p> <p>CATERPILLAR 1328876 CATERPILLAR 4T-3132</p>  <p>H 1 : 228.2 (mm) H 2 : 225 (mm) OD 1 : 130 (mm) OD 2 : 130 (mm) ID 1 : 84.4 (mm) ID 2 : 84.4 (mm)</p> <p>CONT : 6 VOL : 0.031</p>	<p>H-55332</p> <p>Hydraulic Oil Filter Metal End Cap Element With Glass Fiber Media</p> <p>INTERNORMEN 020030D10VG30</p>  <p>H 1 : 92.5 (mm) H 2 : 90 (mm) OD 1 : 35 (mm) OD 2 : 35 (mm) ID 1 : 11.5 (mm)</p> <p>CONT : 100 VOL : 0.019</p>

















Technical Specification

<p>H-55340</p> <p>Hydraulic Oil Filter Metal End Cap Element</p> <p>SHANTUI Y246-78A-070030</p>  <p>H 1 : 245 (mm) H 2 : 238 (mm) OD 1 : 150 (mm) OD 2 : 150 (mm) ID 1 : 112.8 (mm) Thread Size : M10X1.5</p> <p>CONT : 9 VOL : 0.000</p>	<p>H-55390</p> <p>Hydraulic Oil Filter Metal End Cap Element</p> <p>CATERPILLAR 5J-8877</p>  <p>H 1 : 155 (mm) H 2 : 152 (mm) OD 1 : 130 (mm) OD 2 : 130 (mm) ID 1 : 85 (mm) ID 2 : 85 (mm)</p> <p>CONT : 9 VOL : 0.036</p>	<p>H-5605</p> <p>Hydraulic Oil Filter Metal End Cap Element</p> <p>WARTSILA DIESEL 5611-F-216</p>  <p>H 1 : 291 (mm) OD 1 : 126 (mm) OD 2 : 126 (mm) ID 1 : 91.6 (mm) ID 2 : 14 (mm)</p> <p>CONT : 10 VOL : 0.064</p> <p>Note : Equipment with Wartsila 2.2L MW Engine</p>
<p>H-55350</p> <p>Hydraulic Oil Filter Metal End Cap Element</p> <p>CATERPILLAR 994776</p>  <p>H 1 : 96 (mm) H 2 : 90 (mm) OD 1 : 150 (mm) OD 2 : 150 (mm) ID 1 : 59.5 (mm) Thread Size : M10X1.5</p> <p>CONT : 20 VOL : 0.066</p>	<p>H-55400</p> <p>Hydraulic Oil Filter Metal End Cap Element</p> <p>CATERPILLAR 361-7480</p>  <p>H 1 : 104 (mm) H 2 : 100 (mm) OD 1 : 45 (mm) OD 2 : 45 (mm) ID 1 : 19.5 (mm)</p> <p>CONT : 50 VOL : 0.017</p> <p>Note : for Caterpillar M318D</p>	<p>H-5606</p> <p>Hydraulic Oil Filter Metal End Cap Element</p> <p>KOMATSU 175-49-11580 KOMATSU 2-3EB-66-21140</p>  <p>H 1 : 233.3 (mm) H 2 : 231 (mm) OD 1 : 100 (mm) OD 2 : 100 (mm) ID 1 : 42 (mm) ID 2 : 35.8 (mm)</p> <p>CONT : 20 VOL : 0.074</p>
<p>H-55360</p> <p>Hydraulic Oil Filter Metal End Cap Element</p> <p>CATERPILLAR 304-7196</p>  <p>H 1 : 230 (mm) OD 1 : 82 (mm) OD 2 : 82 (mm) ID 1 : 41 (mm) ID 2 : 41 (mm)</p> <p>CONT : 25 VOL : 0.048</p>	<p>H-55420</p> <p>Hydraulic Oil Filter Power steering Metal End Cap Element</p> <p>INTERNATIONAL HARVESTER 1698964-C92 NELSON 87904F NELSON 87904M</p>  <p>H 1 : 70.4 (mm) H 2 : 65 (mm) OD 1 : 85 (mm) OD 2 : 85 (mm) ID 1 : 21 (mm) ID 2 : 21 (mm)</p> <p>CONT : 50 VOL : 0.036</p>	<p>H-5607</p> <p>Hydraulic Oil Filter Metal End Cap Element</p> <p>KOMATSU 07063-01054 KOMATSU 154-60-12170 KOMATSU ZZ0706301054</p>  <p>H 1 : 211 (mm) OD 1 : 100 (mm) OD 2 : 100 (mm) ID 1 : 60 (mm) ID 2 : 60 (mm)</p> <p>CONT : 20 VOL : 0.059</p>
<p>H-55370</p> <p>Hydraulic Oil Filter Metal End Cap Element</p> <p>CATERPILLAR 266-7796</p>  <p>H 1 : 383.4 (mm) H 2 : 376 (mm) OD 1 : 120 (mm) OD 2 : 120 (mm) ID 1 : 83 (mm) ID 2 : 83 (mm)</p> <p>CONT : 9 VOL : 0.074</p>	<p>H-5601</p> <p>Hydraulic Oil Filter Metal End Cap Element</p> <p>KOMATSU 144-60-11160</p>  <p>H 1 : 277 (mm) OD 1 : 100 (mm) OD 2 : 100 (mm) ID 1 : 60 (mm) ID 2 : 60 (mm)</p> <p>CONT : 25 VOL : 0.092</p>	<p>H-5608</p> <p>Hydraulic Oil Filter Metal End Cap Element</p> <p>KOMATSU 130-60-48210</p>  <p>H 1 : 278.5 (mm) OD 1 : 65 (mm) OD 2 : 65 (mm) ID 1 : 25.5 (mm) ID 2 : 25.5 (mm)</p> <p>CONT : 25 VOL : 0.041</p>
<p>H-55380</p> <p>Hydraulic Oil Filter Metal End Cap Element</p> <p>CATERPILLAR 3I0587 COMP AIR 9826250820001 PALL HC9600FDT13H PALL HC9600FKT13H</p>  <p>H 1 : 328 (mm) H 2 : 324 (mm) OD 1 : 79 (mm) OD 2 : 79 (mm) ID 1 : 42 (mm)</p> <p>CONT : 25 VOL : 0.084</p>	<p>H-5602</p> <p>Hydraulic Oil Filter Metal End Cap Element</p> <p>KOMATSU 154-19-12130</p>  <p>H 1 : 233.7 (mm) H 2 : 231.5 (mm) OD 1 : 100 (mm) OD 2 : 100 (mm) ID 1 : 42 (mm) ID 2 : 42 (mm)</p> <p>CONT : 20 VOL : 0.074</p>	<p>H-5609</p> <p>Hydraulic Oil Filter Metal End Cap Element Cellulose media</p> <p>KOMATSU 07063-01142 KOMATSU 07063-01412 KOMATSU 195-60-16320</p>  <p>H 1 : 300.5 (mm) OD 1 : 150 (mm) OD 2 : 150 (mm) ID 1 : 110 (mm) ID 2 : 110 (mm)</p> <p>CONT : 6 VOL : 0.059</p>

















Technical Specification

<p>H-5610</p> <p>Hydraulic Oil Filter Metal End Cap Element</p> <p>KOMATSU 07063-01100 KOMATSU 141-60-18270 KOMATSU 175-60-27380</p>  <p>H 1 : 292 (mm) OD 1 : 130 (mm) OD 2 : 130 (mm) ID 1 : 86 (mm) ID 2 : 86 (mm)</p> <p>CONT : 6 VOL : 0.040</p>	<p>H-5618</p> <p>Hydraulic Oil Filter Metal End Cap Element</p> <p>MITSUBISHI 385-10100021 MITSUBISHI 385-10100022 KOMATSU 424-16-11140</p>  <p>H 1 : 229.6 (mm) H 2 : 227 (mm) OD 1 : 110 (mm) OD 2 : 110 (mm) ID 1 : 44 (mm) ID 2 : 44 (mm)</p> <p>CONT : 20 VOL : 0.075</p>	<p>H-5624</p> <p>Hydraulic Oil Filter Metal End Cap Element</p> <p>KOMATSU 3EA-15-11600</p>  <p>H 1 : 198.8 (mm) H 2 : 166.3 (mm) OD 1 : 43.4 (mm) OD 2 : 43.4 (mm) ID 1 : 26 (mm)</p> <p>CONT : 25 VOL : 0.013</p>
<p>H-5611</p> <p>Hydraulic Oil Filter Metal End Cap Element</p> <p>KOMATSU 101-60-15170 KOMATSU 101-60-15171</p>  <p>H 1 : 143 (mm) OD 1 : 64.8 (mm) OD 2 : 64.8 (mm) ID 1 : 25.5 (mm) ID 2 : 25.5 (mm)</p> <p>CONT : 50 VOL : 0.041</p>	<p>H-5620</p> <p>Hydraulic Oil Filter Metal End Cap Element</p> <p>KOMATSU 281-16-11290 KOMATSU 287-16-11510</p>  <p>H 1 : 233 (mm) OD 1 : 100 (mm) OD 2 : 100 (mm) ID 1 : 42 (mm) ID 2 : 42 (mm)</p> <p>CONT : 20 VOL : 0.076</p>	<p>H-5625</p> <p>Hydraulic Oil Filter Metal End Cap Element</p> <p>YANMAR 172141-73760 KOMATSU 311781-31140</p>  <p>H 1 : 178 (mm) OD 1 : 89 (mm) OD 2 : 89 (mm) ID 1 : 60 (mm) ID 2 : 60 (mm)</p> <p>CONT : 25 VOL : 0.057</p>
<p>H-5613</p> <p>Hydraulic Oil Filter Metal End Cap Element</p> <p>KOMATSU 205-60-51450</p>  <p>H 1 : 197 (mm) H 2 : 190 (mm) OD 1 : 150 (mm) OD 2 : 150 (mm) ID 1 : 73.5 (mm) Thread Size : M10X1.5</p> <p>CONT : 9 VOL : 0.053</p>	<p>H-5621</p> <p>Hydraulic Oil Filter Metal End Cap Element</p> <p>KOMATSU 175-43-14130</p>  <p>H 1 : 231.5 (mm) OD 1 : 100 (mm) OD 2 : 100 (mm) ID 1 : 42 (mm) ID 2 : 42 (mm)</p> <p>CONT : 20 VOL : 0.074</p>	<p>H-5628</p> <p>Hydraulic Oil Filter Element</p> <p>MITSUBISHI 92576-14100</p>  <p>H 1 : 298 (mm) H 2 : 280 (mm) OD 1 : 90 (mm) OD 2 : 90 (mm) Thread Size : 1X11 BSPT</p> <p>CONT : 10 VOL : 0.038</p> <p>Note : for Komatsu 4D95 Forklift, Komatsu 4D94LE NEW (FORKLIFT)</p>
<p>H-5614</p> <p>Hydraulic Oil Filter Metal End Cap Element</p> <p>KOBELCO 3008679</p>  <p>H 1 : 156.3 (mm) H 2 : 151 (mm) OD 1 : 73 (mm) OD 2 : 73 (mm) ID 1 : 35 (mm)</p> <p>CONT : 50 VOL : 0.059</p>	<p>H-5622</p> <p>Hydraulic Oil Filter Metal End Cap Element</p> <p>KOMATSU 198-49-11440</p>  <p>H 1 : 291.5 (mm) OD 1 : 112 (mm) OD 2 : 112 (mm) ID 1 : 70 (mm) ID 2 : 70 (mm)</p> <p>CONT : 10 VOL : 0.091</p>	<p>H-5629</p> <p>Hydraulic Oil Filter Metal End Cap Element with synthetic media</p> <p>KOMATSU 207-60-71180</p>  <p>H 1 : 200 (mm) OD 1 : 150 (mm) OD 2 : 150 (mm) ID 1 : 92 (mm) ID 2 : 92 (mm)</p> <p>CONT : 10 VOL : 0.069</p>
<p>H-5615</p> <p>Hydraulic Oil Filter Metal End Cap Element</p> <p>KOBELCO 3008679</p>  <p>H 1 : 113 (mm) OD 1 : 73 (mm) OD 2 : 73 (mm) ID 1 : 35 (mm) ID 2 : 35 (mm)</p> <p>CONT : 50 VOL : 0.056</p>	<p>H-5623</p> <p>Hydraulic Oil Filter Metal End Cap Element</p> <p>KOMATSU 209-60-12840</p>  <p>H 1 : 131.5 (mm) OD 1 : 73 (mm) OD 2 : 73 (mm) ID 1 : 36 (mm)</p> <p>CONT : 50 VOL : 0.062</p>	<p>H-5630</p> <p>Hydraulic Oil Filter Wire Mesh supported Element</p> <p>KOMATSU 203-60-21141</p>  <p>H 1 : 177.5 (mm) H 2 : 174.5 (mm) OD 1 : 108 (mm) OD 2 : 108 (mm) ID 1 : 62 (mm) Thread Size : M10X1.5</p> <p>CONT : 25 VOL : 0.075</p>

















Technical Specification

<p>H-5631</p> <p>Hydraulic Oil Filter Wire Mesh supported Element</p> <p>KOMATSU 203-60-31150</p>  <p>H 1 : 160.5 (mm) H 2 : 152 (mm) OD 1 : 124 (mm) OD 2 : 124 (mm) ID 1 : 59.5 (mm) Thread Size : M10X1.5</p> <p>CONT : 20 VOL : 0.077</p>	<p>H-5636</p> <p>Hydraulic Oil Filter Element With Glass Fiber Media</p> <p>KOMATSU 207-970-5121</p>  <p>H 1 : 207.4 (mm) H 2 : 200 (mm) OD 1 : 100 (mm) OD 2 : 100 (mm) ID 1 : 45.6 (mm)</p> <p>CONT : 9 VOL : 0.030</p>	<p>H-5641</p> <p>Hydraulic Oil Filter Metal End Cap Element</p> <p>KOMATSU 144-49-13853</p>  <p>H 1 : 162.6 (mm) H 2 : 139.5 (mm) OD 1 : 60 (mm) OD 2 : 60 (mm) ID 1 : 26.5 (mm) ID 2 : 26.5 (mm)</p> <p>CONT : 25 VOL : 0.021</p>
<p>H-5632</p> <p>Hydraulic Oil Filter Element</p> <p>KOMATSU 3EB-66-11711 KOMATSU 3EB6-61-1710 KOMATSU 3EB6-61-1711 KOMATSU 3EB7-61-1710 KOMATSU 3EB7-61-1711</p>  <p>H 1 : 165 (mm) H 2 : 152 (mm) OD 1 : 90 (mm) OD 2 : 90 (mm) Thread Size : 3/4 BSPT</p> <p>CONT : 25 VOL : 0.053</p>	<p>H-5637</p> <p>Hydraulic Oil Filter Metal End Cap Element With Glass Fiber Media</p> <p>KOMATSU 07063-11046</p>  <p>H 1 : 232.5 (mm) H 2 : 228 (mm) OD 1 : 95 (mm) OD 2 : 95 (mm) ID 1 : 49.5 (mm)</p> <p>CONT : 9 VOL : 0.026</p>	<p>H-5643</p> <p>Hydraulic Oil Filter Pilot Metal End Cap Element</p> <p>KOBELCO YN 50V01001S005</p>  <p>H 1 : 48.5 (mm) H 2 : 45 (mm) OD 1 : 42.5 (mm) OD 2 : 42.5 (mm) ID 1 : 21.5 (mm)</p> <p>CONT : 50 VOL : 0.008</p>
<p>H-5633</p> <p>Hydraulic Oil Filter Element</p> <p>KOMATSU 3EA-66-33560 HITACHI 4711728</p>  <p>H 1 : 93 (mm) H 2 : 64 (mm) OD 1 : 70.3 (mm) OD 2 : 63 (mm) ID 1 : 40.6 (mm)</p> <p>CONT : 25 VOL : 0.019</p>	<p>H-5638</p> <p>Hydraulic Oil Filter Wire Mesh supported Element with magnet</p> <p>KOMATSU 124-15-51740 KOMATSU 125-15-11721 KOMATSU 125-15-11722</p>  <p>H 1 : 149 (mm) H 2 : 97.5 (mm) OD 1 : 48 (mm) OD 2 : 48 (mm) ID 1 : 29.5 (mm) ID 2 : 27 (mm)</p> <p>CONT : 25 VOL : 0.015</p>	<p>H-56431</p> <p>Hydraulic Oil Filter Pilot Metal End Cap Element With Glass Fiber Media</p> <p>YANMAR 172837-73730</p>  <p>H 1 : 50 (mm) H 2 : 46.5 (mm) OD 1 : 42.5 (mm) OD 2 : 42.5 (mm) ID 1 : 21.5 (mm)</p> <p>CONT : 50 VOL : 0.007</p>
<p>H-5634</p> <p>Hydraulic Oil Filter Metal End Cap Element</p> <p>YANMAR 172175-73710 KOBELCO PR50V00002P1 CASE STEYR PR50V00002P1P</p>  <p>H 1 : 231 (mm) OD 1 : 89 (mm) OD 2 : 89 (mm) ID 1 : 60 (mm) ID 2 : 60 (mm)</p> <p>CONT : 25 VOL : 0.072</p>	<p>H-5639</p> <p>Hydraulic Oil Filter Metal End Cap Element with synthetic media</p> <p>KOMATSU 208-60-71121 KOMATSU 208-60-71122A</p>  <p>H 1 : 200 (mm) OD 1 : 180 (mm) OD 2 : 180 (mm) ID 1 : 110 (mm) ID 2 : 110 (mm)</p> <p>CONT : 6 VOL : 0.049</p>	<p>H-5646</p> <p>Hydraulic Oil Filter Metal End Cap Element Cellulose media</p> <p>KOMATSU 207-60-71180</p>  <p>H 1 : 200 (mm) OD 1 : 150 (mm) OD 2 : 150 (mm) ID 1 : 92 (mm) ID 2 : 92 (mm)</p> <p>CONT : 10 VOL : 0.071</p> <p>Note : H-5629 (Media difference)</p>
<p>H-5635</p> <p>Hydraulic Oil Filter Metal End Cap Element</p> <p>KOMATSU 22B-60-11160</p>  <p>H 1 : 138.5 (mm) H 2 : 130.5 (mm) OD 1 : 125 (mm) OD 2 : 124 (mm) ID 1 : 97.8 (mm) Thread Size : M10X1.5</p> <p>CONT : 12 VOL : 0.037</p>	<p>H-5640</p> <p>Hydraulic Oil Filter Metal End Cap Element</p> <p>CASE 884879C1 INTERNATIONAL HARVESTER 884879C1 CASE D32212</p>  <p>H 1 : 122.5 (mm) H 2 : 117 (mm) OD 1 : 66 (mm) OD 2 : 66.5 (mm) ID 1 : 30 (mm)</p> <p>CONT : 50 VOL : 0.038</p>	<p>H-5649</p> <p>Hydraulic Oil Filter Metal End Cap Element with synthetic media</p> <p>KOMATSU 07063-51383</p>  <p>H 1 : 449.8 (mm) OD 1 : 180 (mm) OD 2 : 180 (mm) ID 1 : 110 (mm) ID 2 : 110 (mm)</p> <p>CONT : 1 VOL : 0.019</p>



Technical Specification

<p>H-5651</p> <p>Hydraulic Oil Filter Metal End Cap Element</p> <p>KOMATSU 569-16-81160A</p>  <p>H 1 : 228.4 (mm) OD 1 : 110 (mm) OD 2 : 110 (mm) ID 1 : 44.5 (mm) ID 2 : 44.5 (mm)</p> <p>CONT : 12 VOL : 0.044</p>	<p>H-56560</p> <p>Hydraulic Oil Filter Metal End Cap Element</p> <p>KOMATSU 42Y-60-H5080</p>  <p>H 1 : 349 (mm) OD 1 : 148 (mm) OD 2 : 148 (mm) ID 1 : 104.7 (mm) ID 2 : 104.7 (mm)</p> <p>CONT : 6 VOL : 0.063</p>	<p>H-56610</p> <p>Hydraulic Oil Filter Tank Breather Foam Element</p> <p>KOMATSU 20Y-60-21470</p>  <p>H 1 : 23 (mm) OD 1 : 47 (mm) OD 2 : 47 (mm) ID 1 : 33 (mm) ID 2 : 33 (mm)</p> <p>CONT : 100 VOL : 0.008</p>
<p>H-5652</p> <p>Hydraulic Oil Filter Metal End Cap Element</p> <p>KOMATSU 285-62-17320A</p>  <p>H 1 : 51.8 (mm) OD 1 : 52 (mm) OD 2 : 52 (mm) ID 1 : 37.5 (mm) ID 2 : 37.5 (mm)</p> <p>CONT : 12 VOL : 0.003</p>	<p>H-56570</p> <p>Hydraulic Oil Filter Transmission Wire Mesh supported Element</p> <p>KOMATSU 195-13-13420</p>  <p>H 1 : 90 (mm) H 2 : 85.5 (mm) OD 1 : 57 (mm) OD 2 : 57 (mm) ID 1 : 43 (mm) ID 2 : 6.6 (mm)</p> <p>CONT : 50 VOL : 0.021</p>	<p>H-56620</p> <p>Hydraulic Oil Filter Metal End Cap Element</p> <p>KOMATSU 20Y-60-31140</p>  <p>H 1 : 129.8 (mm) OD 1 : 130 (mm) OD 2 : 75 (mm) ID 1 : 68.5 (mm)</p> <p>CONT : 50 VOL : 0.136</p>
<p>H-56530</p> <p>Hydraulic Oil Filter Metal End Cap Element with synthetic media</p> <p>KOMATSU 22L-60-22120</p>  <p>H 1 : 131 (mm) OD 1 : 83.2 (mm) OD 2 : 83.2 (mm) ID 1 : 42.2 (mm) ID 2 : 42.2 (mm)</p> <p>CONT : 12 VOL : 0.015</p>	<p>H-56580</p> <p>Hydraulic Oil Filter Metal End Cap Element</p> <p>KOMATSU 569-43-83920</p>  <p>H 1 : 207.5 (mm) H 2 : 203 (mm) OD 1 : 51 (mm) OD 2 : 51 (mm) ID 1 : 23 (mm)</p> <p>CONT : 12 VOL : 0.016</p>	<p>H-56630</p> <p>Hydraulic Oil Filter Metal End Cap Element</p> <p>KOMATSU 3ED-66-42111</p>  <p>H 1 : 168 (mm) H 2 : 150 (mm) OD 1 : 115 (mm) OD 2 : 114 (mm) ID 1 : 36 (mm)</p> <p>CONT : 20 VOL : 0.062</p> <p>Note : Komatsu Dozers D31S-18</p>
<p>H-56540</p> <p>Hydraulic Oil Filter Metal End Cap Element Synthetic Media</p> <p>KOMATSU 21W-60-41121</p>  <p>H 1 : 100 (mm) OD 1 : 110 (mm) OD 2 : 110 (mm) ID 1 : 61 (mm) ID 2 : 61 (mm)</p> <p>CONT : 12 VOL : 0.023</p>	<p>H-56590</p> <p>Hydraulic Oil Filter Metal End Cap Element with synthetic media</p> <p>KOMATSU 209-60-77532</p>  <p>H 1 : 400 (mm) H 2 : 400 (mm) OD 1 : 150 (mm) OD 2 : 150 (mm) ID 1 : 92 (mm) ID 2 : 92 (mm)</p> <p>CONT : 1 VOL : 0.011</p>	<p>H-56640</p> <p>Hydraulic Oil Filter Transmission Metal End Cap Element</p> <p>KOMATSU 419-15-16930</p>  <p>H 1 : 76.5 (mm) H 2 : 73 (mm) OD 1 : 38.5 (mm) OD 2 : 38 (mm) ID 1 : 21 (mm)</p> <p>CONT : 50 VOL : 0.008</p>
<p>H-56550</p> <p>Hydraulic Oil Filter Metal End Cap Element With Glass Fiber Media</p> <p>KOMATSU 07063-51210</p>  <p>H 1 : 450 (mm) OD 1 : 150 (mm) OD 2 : 150 (mm) ID 1 : 110 (mm) ID 2 : 110 (mm)</p> <p>CONT : 10 VOL : 0.135</p>	<p>H-56600</p> <p>Hydraulic Oil Filter Metal End Cap Element with synthetic media</p> <p>KOMATSU 07063-51100</p>  <p>H 1 : 292 (mm) OD 1 : 130 (mm) OD 2 : 130 (mm) ID 1 : 86 (mm) ID 2 : 86 (mm)</p> <p>CONT : 1 VOL : 0.007</p>	<p>H-56650</p> <p>Hydraulic Oil Filter Metal End Cap Element With Glass Fiber Media</p> <p>KOMATSU 14X-60-31150</p>  <p>H 1 : 200 (mm) OD 1 : 110 (mm) OD 2 : 110 (mm) ID 1 : 61 (mm) ID 2 : 61 (mm)</p> <p>CONT : 9 VOL : 0.029</p>



Technical Specification

H-56660 Hydraulic Oil Filter Element
KOMATSU 714-07-14522



H 1 : 172 (mm)
OD 1 : 96 (mm)
OD 2 : 76.5 (mm)
ID 1 : 50 (mm)

CONT : 25
VOL : 0.053

H-56720 Hydraulic Oil Filter Metal End Cap Element
KOMATSU 419-60-15250



H 1 : 51.6 (mm)
OD 1 : 56 (mm)
OD 2 : 56 (mm)
ID 1 : 37.7 (mm)

CONT : 12
VOL : 0.004

H-57060 Hydraulic Oil Filter Wire Mesh supported Element



H 1 : 125 (mm)
H 2 : 118 (mm)
OD 1 : 150 (mm)
OD 2 : 150 (mm)
ID 1 : 96.6 (mm)
Thread Size : M12X1.75

CONT : 9
VOL : 0.044

H-56670 Hydraulic Oil Filter Metal End Cap Element
KOMATSU 581-91-19120



H 1 : 186 (mm)
H 2 : 130 (mm)
OD 1 : 73 (mm)
OD 2 : 73 (mm)
ID 1 : 39 (mm)

CONT : 16
VOL : 0.028

H-56740 Hydraulic Oil Filter Aluminium Casting Element
KOMATSU 562-15-11570



H 1 : 255 (mm)
H 2 : 138.5 (mm)
OD 1 : 78 (mm)
OD 2 : 70 (mm)
ID 1 : 10 (mm)
Thread Size : M10X1.5

CONT : 25
VOL : 0.058

Note : with magnet

H-57070 Hydraulic Oil Filter Metal End Cap Element
SANY P0-C0-01-01430



H 1 : 516.5 (mm)
H 2 : 511.5 (mm)
OD 1 : 150 (mm)
OD 2 : 150 (mm)
ID 1 : 98 (mm)
ID 2 : 98 (mm)

CONT : 4
VOL : 0.103

H-56680 Hydraulic Oil Filter Transmission Metal End Cap Element
KOMATSU 562-15-11570



H 1 : 153.5 (mm)
H 2 : 138.5 (mm)
OD 1 : 78 (mm)
OD 2 : 70 (mm)

CONT : 25
VOL : 0.030

Note : magnet not included

H-57030 Hydraulic Oil Filter Metal End Cap Element



CASE-IH CNH 104929
CASE-IH CNH 105892
CATERPILLAR 3I0457
CATERPILLAR 3I0473
FIAT 4853388

H 1 : 408 (mm)
H 2 : 406 (mm)
OD 1 : 110 (mm)
OD 2 : 110 (mm)
ID 1 : 63 (mm)
ID 2 : 20 (mm)

CONT : 9
VOL : 0.069

H-5802 Hydraulic Oil Filter Element
CATERPILLAR 91375-03800
MITSUBISHI 91375-03800



H 1 : 167 (mm)
H 2 : 150 (mm)
OD 1 : 90 (mm)
OD 2 : 90 (mm)
Thread Size : 1X11 BSPT

CONT : 25
VOL : 0.051

H-56700 Hydraulic Oil Filter Wire Mesh supported Element
KOMATSU 421-43-H0P43



H 1 : 71 (mm)
H 2 : 65.5 (mm)
OD 1 : 56 (mm)
OD 2 : 56 (mm)
ID 1 : 27 (mm)

CONT : 50
VOL : 0.017

Note : Komatsu wheel Loader WA320-3H Active, WA420-3H

H-57040 Hydraulic Oil Filter Wire Mesh supported Element
TEREX 15266831



H 1 : 135.5 (mm)
H 2 : 119 (mm)
OD 1 : 60.5 (mm)
OD 2 : 60 (mm)
ID 1 : 25.5 (mm)

CONT : 25
VOL : 0.021

H-5803 Hydraulic Oil Filter Wire Mesh supported Element
KOBELCO 2446R307S1
HITACHI 673340
KOBELCO K907



H 1 : 96 (mm)
H 2 : 89 (mm)
OD 1 : 150 (mm)
OD 2 : 150 (mm)
ID 1 : 96.6 (mm)
Thread Size : M10X1.5

CONT : 9
VOL : 0.031

H-56710 Hydraulic Oil Filter Wire Mesh supported Element
KOMATSU 209-60-51120



H 1 : 242 (mm)
H 2 : 230 (mm)
OD 1 : 200 (mm)
OD 2 : 200 (mm)
ID 1 : 134 (mm)
Thread Size : M10X1.5

CONT : 4
VOL : 0.053

H-57050 Hydraulic Oil Filter Wire Mesh supported Element
SANY 60200363



H 1 : 200 (mm)
H 2 : 193 (mm)
OD 1 : 150 (mm)
OD 2 : 150 (mm)
ID 1 : 97 (mm)
Thread Size : M12X1.75

CONT : 9
VOL : 0.060

H-58040 Hydraulic Oil Filter Element
MITSUBISHI 91375-23600

















H 1 : 91 (mm)
H 2 : 75 (mm)
OD 1 : 98.5 (mm)
OD 2 : 98.5 (mm)
Thread Size : 1"X11 BSPT

CONT : 50
VOL : 0.054



Technical Specification

<p>H-5901</p> <p>Hydraulic Oil Filter Return Metal body In-Line</p> <p>TOYOTA 1001577 TOYOTA 67502-23000-71</p>  <p>H 1 : 137 (mm) H 2 : 120 (mm) OD 1 : 100 (mm) OD 2 : 108 (mm) Outlet : 27 (mm) Inlet : 3/4 PT</p> <p>CONT : 10 VOL : 0.025</p>	<p>H-5907</p> <p>Hydraulic Oil Filter In-Line</p> <p>TOYOTA 67502-32881-71</p>  <p>H 1 : 192.3 (mm) OD 1 : 100 (mm) Outlet : 41 (mm) Inlet : 1X11 BSP</p> <p>CONT : 10 VOL : 0.034</p>	<p>H-5912</p> <p>Hydraulic Oil Filter Wire Mesh supported Element</p> <p>TOYOTA 32405-31940-71</p>  <p>H 1 : 47.1 (mm) H 2 : 46.6 (mm) OD 1 : 57 (mm) OD 2 : 57 (mm) ID 1 : 43 (mm) ID 2 : 6.6 (mm)</p> <p>CONT : 50 VOL : 0.011</p>
<p>H-5902</p> <p>Hydraulic Oil Filter In-Line</p> <p>TOYOTA 1001576 HYSTER 1360557 TOYOTA 67502-20540-71</p>  <p>H 1 : 200 (mm) H 2 : 120 (mm) OD 1 : 100.3 (mm) OD 2 : 108 (mm) Inlet : 27.5 (mm) Outlet : 27.5 (mm)</p> <p>CONT : 10 VOL : 0.039</p>	<p>H-5908</p> <p>Hydraulic Oil Filter In-Line</p> <p>TOYOTA 67502-13300-71</p>  <p>H 1 : 177.3 (mm) H 2 : 120 (mm) OD 1 : 100.3 (mm) OD 2 : 108 (mm) Outlet : 27.5 (mm) Inlet : 3/4"XNPT</p> <p>CONT : 10 VOL : 0.031</p>	<p>H-5913</p> <p>Hydraulic Oil Filter Wire Mesh supported Element</p> <p>TOYOTA 40666-30130-71</p>  <p>H 1 : 181 (mm) H 2 : 176.5 (mm) OD 1 : 57 (mm) OD 2 : 57 (mm) ID 1 : 43 (mm) ID 2 : 6.6 (mm)</p> <p>CONT : 50 VOL : 0.038</p>
<p>H-5903</p> <p>Hydraulic Oil Filter In-Line</p> <p>TOYOTA 25967-82001</p>  <p>H 1 : 190 (mm) H 2 : 120 (mm) OD 1 : 100.3 (mm) OD 2 : 108 (mm) Inlet : 19 (mm) Outlet : 19 (mm)</p> <p>CONT : 16 VOL : 0.044</p>	<p>H-5909</p> <p>Hydraulic Oil Filter Element</p> <p>KOMATSU 201-60-22150</p>  <p>H 1 : 160 (mm) H 2 : 157 (mm) OD 1 : 95 (mm) OD 2 : 95 (mm) ID 1 : 50 (mm) Thread Size : M10X1.5</p> <p>CONT : 25 VOL : 0.053</p>	<p>H-5914</p> <p>Hydraulic Oil Filter Suction Metal End Cap Element</p> <p>TOYOTA 67501-23001-71</p>  <p>H 1 : 110.5 (mm) H 2 : 96 (mm) OD 1 : 79 (mm) OD 2 : 79 (mm) Thread Size : 1X11 BSP</p> <p>CONT : 25 VOL : 0.025</p>
<p>H-5904</p> <p>Hydraulic Oil Filter In-Line</p> <p>TOYOTA 25597-60301</p>  <p>H 1 : 194 (mm) H 2 : 120 (mm) OD 1 : 96.5 (mm) OD 2 : 108 (mm) Inlet : 36.6 (mm) Outlet : 36.6 (mm)</p> <p>CONT : 10 VOL : 0.034</p>	<p>H-5910</p> <p>Hydraulic Oil Filter Return In-Line</p> <p>HYUNDAI 37HN-30070 TOYOTA 67503-23321-71</p>  <p>H 1 : 125 (mm) H 2 : 120 (mm) OD 1 : 100.3 (mm) OD 2 : 108 (mm) Inlet : 26.5 (mm) Outlet : 27 (mm)</p> <p>CONT : 10 VOL : 0.023</p>	<p>H-5918</p> <p>Hydraulic Oil Filter Metal End Cap Element</p> <p>TOYOTA 67501-20540-71</p>  <p>H 1 : 109 (mm) H 2 : 99 (mm) OD 1 : 79 (mm) OD 2 : 79 (mm) Thread Size : 3/4X14 BSP</p> <p>CONT : 25 VOL : 0.025</p>
<p>H-5905</p> <p>Hydraulic Oil Filter Metal body In-Line</p> <p>TOYOTA 32901-31630-71</p>  <p>H 1 : 200 (mm) H 2 : 120 (mm) OD 1 : 100.3 (mm) OD 2 : 108 (mm) Inlet : 22 (mm) Outlet : 22 (mm)</p> <p>CONT : 10 VOL : 0.039</p>	<p>H-5911</p> <p>Hydraulic Oil Filter Wire Mesh supported Element</p> <p>TOYOTA 67502-23320-71</p>  <p>H 1 : 97 (mm) OD 1 : 79 (mm) OD 2 : 79 (mm) ID 1 : 33 (mm) Thread Size : M6X1.0</p> <p>CONT : 50 VOL : 0.039</p>	<p>H-5919</p> <p>Hydraulic Oil Filter In-Line</p> <p>TOYOTA 67502-26600-71 TOYOTA 67502-U2230-71</p>  <p>H 1 : 200 (mm) H 2 : 120 (mm) OD 1 : 100.3 (mm) OD 2 : 108 (mm) Inlet : 27.5 (mm) Outlet : 27.5 (mm)</p> <p>CONT : 10 VOL : 0.041</p>



Technical Specification

H-59200 Hydraulic Oil Filter In-Line
TCM 25967-80201A



H 1 : 190 (mm)
H 2 : 120 (mm)
OD 1 : 100.3 (mm)
OD 2 : 108 (mm)
Inlet : 21.5 (mm)
Outlet : 21.5 (mm)

CONT : 10
VOL : 0.039

H-60020 Hydraulic Oil Filter Return Metal body In-Line
TCM 243L7-82001



H 1 : 190 (mm)
H 2 : 120 (mm)
OD 1 : 100 (mm)
OD 2 : 108 (mm)
Inlet : 13 (mm)
Outlet : 13 (mm)

CONT : 10
VOL : 0.039

H-62050 Hydraulic Oil Filter Metal End Cap Element
LIEBHERR 510669708



H 1 : 356 (mm)
H 2 : 250 (mm)
OD 1 : 130 (mm)
OD 2 : 130 (mm)
ID 1 : 63 (mm)

CONT : 9
VOL : 0.081

H-59210 Hydraulic Oil Filter Return In-Line
TCM 25787-80301A



H 1 : 190 (mm)
H 2 : 120 (mm)
OD 1 : 100.3 (mm)
OD 2 : 108 (mm)
Inlet : 21.5 (mm)
Outlet : 21.5 (mm)

CONT : 10
VOL : 0.039

H-62010 Hydraulic Oil Filter Metal End Cap Element with synthetic media
LIEBHERR 006 152 03 P
LIEBHERR 063 152 030 F
LIEBHERR 065 152 030 F
LIEBHERR 065 152 030 FL
LIEBHERR 721 1198



H 1 : 415 (mm)
OD 1 : 152 (mm)
OD 2 : 152 (mm)
ID 1 : 89 (mm)
ID 2 : 89 (mm)

CONT : 6
VOL : 0.076

H-62060 Hydraulic Oil Filter Metal End Cap Element
LIEBHERR 510669208
F.B.O CR33002
MECALAC/PELJOP E605A0006



H 1 : 303 (mm)
H 2 : 200 (mm)
OD 1 : 130 (mm)
OD 2 : 130 (mm)
ID 1 : 63 (mm)

CONT : 9
VOL : 0.068

H-59220 Hydraulic Oil Filter In-Line
TCM 25967-82002



H 1 : 190 (mm)
H 2 : 120 (mm)
OD 1 : 108 (mm)
OD 2 : 108 (mm)
Inlet : 20 (mm)
Outlet : 20 (mm)

CONT : 10
VOL : 0.039

H-62020 Hydraulic Oil Filter Metal End Cap Element with synthetic media
LIEBHERR 063 102 050 F
LIEBHERR 064 102 052 F
LIEBHERR 736 0470



H 1 : 460 (mm)
OD 1 : 100 (mm)
OD 2 : 100 (mm)
ID 1 : 63 (mm)
ID 2 : 63 (mm)

CONT : 6
VOL : 0.049

H-62070 Hydraulic Oil Filter Metal End Cap Element With Glass Fiber Media
LIEBHERR 10037616
CATERPILLAR 311935
LIEBHERR 5705816



H 1 : 83 (mm)
H 2 : 78.5 (mm)
OD 1 : 45 (mm)
OD 2 : 45 (mm)
ID 1 : 21 (mm)

CONT : 50
VOL : 0.014

H-59230 Hydraulic Oil Filter Return In-Line
TOYOTA 67502-36760-71



H 1 : 180 (mm)
H 2 : 175 (mm)
OD 1 : 100 (mm)
OD 2 : 108 (mm)
Inlet : 36 (mm)
Outlet : 41 (mm)

CONT : 12
VOL : 0.036

H-62030 Hydraulic Oil Filter Metal End Cap Element
DYNAPAC 964725500



H 1 : 116.8 (mm)
H 2 : 111 (mm)
OD 1 : 68.6 (mm)
OD 2 : 68.6 (mm)
ID 1 : 33 (mm)

CONT : 50
VOL : 0.036

H-62080 Hydraulic Oil Filter Metal End Cap Element
INTERNORMEN 1E42510VG16SP
INTERNORMEN 1E4251GVG16SP
SCHAEFF 5380658088



H 1 : 311 (mm)
H 2 : 303 (mm)
OD 1 : 83 (mm)
OD 2 : 83 (mm)
ID 1 : 45 (mm)

CONT : 9
VOL : 0.028

H-6001 Hydraulic Oil Filter Element With Glass Fiber Media
CASE 431145A1



H 1 : 252 (mm)
H 2 : 195 (mm)
OD 1 : 128.5 (mm)
OD 2 : 128.5 (mm)
ID 1 : 75 (mm)
ID 2 : 10.8 (mm)

CONT : 16
VOL : 0.093

H-62040 Hydraulic Oil Filter Metal End Cap Element With Glass Fiber Media
HITACHI 71316231
CASE-IH CNH J0150566
FAIREY ARLOX TXW6ACC10



H 1 : 210 (mm)
OD 1 : 126 (mm)
OD 2 : 126 (mm)
ID 1 : 91.6 (mm)
ID 2 : 9 (mm)

CONT : 9
VOL : 0.040

H-62090 Hydraulic Oil Filter Wire Mesh supported Element
HYDAC 0330D010BN3HC
SANY SHF0330D010BN/HC











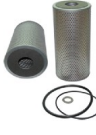





H 1 : 164 (mm)
H 2 : 158.5 (mm)
OD 1 : 90 (mm)
OD 2 : 90 (mm)
ID 1 : 47 (mm)

CONT : 16
VOL : 0.030



Technical Specification

<p>H-62100</p> <p>Hydraulic Oil Filter Metal End Cap Element With Glass Fiber Media</p> <p>HYDAC 240D010BNHC FILTREC DHD240G10B</p>  <p>H 1 : 173 (mm) H 2 : 167 (mm) OD 1 : 69 (mm) OD 2 : 69 (mm) ID 1 : 33.5 (mm)</p> <p>CONT : 25 VOL : 0.029</p>	<p>H-65030</p> <p>Hydraulic Oil Filter Transmission Metal End Cap Element</p> <p>VOLVO 15052 HITACHI 1930779 GENERAL MOTORS 25010836 GENERAL MOTORS 25011193 ALLIS CHALMERS 618179</p>  <p>H 1 : 228 (mm) H 2 : 226 (mm) OD 1 : 109.5 (mm) OD 2 : 109.5 (mm) ID 1 : 38.3 (mm) ID 2 : 38.3 (mm)</p> <p>CONT : 12 VOL : 0.043</p>	<p>H-7102</p> <p>Hydraulic Oil Filter Transmission Metal End Cap Element</p> <p>MERCEDES-BENZ 000 270 10 98 ZF 0501 203 018 ZF 0750 131 003</p>  <p>H 1 : 103.7 (mm) H 2 : 97.3 (mm) OD 1 : 68.6 (mm) OD 2 : 68.6 (mm) ID 1 : 33 (mm)</p> <p>CONT : 50 VOL : 0.037</p>
<p>H-62110</p> <p>Hydraulic Oil Filter Metal End Cap Element</p> <p>KOMATSU 6964737 LIEBHERR 736 4368</p>  <p>H 1 : 213 (mm) H 2 : 167 (mm) OD 1 : 81.5 (mm) OD 2 : 71 (mm) ID 1 : 40 (mm)</p> <p>CONT : 9 VOL : 0.019</p>	<p>H-6701</p> <p>Hydraulic Oil Filter Element With Glass Fiber Media</p> <p>DEMAG 69022273 ATLAS COPCO 8231101804</p>  <p>H 1 : 164.5 (mm) H 2 : 159.5 (mm) OD 1 : 117.8 (mm) OD 2 : 117.8 (mm) ID 1 : 58.8 (mm) ID 2 : 58.8 (mm)</p> <p>CONT : 20 VOL : 0.057</p>	<p>H-7103</p> <p>Hydraulic Oil Filter Transmission Metal End Cap Element</p> <p>IVECO 42491185 DAF 691 954</p>  <p>H 1 : 103.7 (mm) H 2 : 97.3 (mm) OD 1 : 68.6 (mm) OD 2 : 68.6 (mm) ID 1 : 33 (mm)</p> <p>CONT : 50 VOL : 0.037</p>
<p>H-62120</p> <p>Hydraulic Oil Filter Metal End Cap Element</p> <p>LIEBHERR 7368875 LIEBHERR 7373884</p>  <p>H 1 : 950 (mm) H 2 : 940 (mm) OD 1 : 152 (mm) OD 2 : 155 (mm) ID 1 : 80.5 (mm) ID 2 : 99.5 (mm)</p> <p>CONT : 1 VOL : 0.027</p>	<p>H-6902</p> <p>Hydraulic Oil Filter Metal End Cap Element</p> <p>INGERSOLL RAND 3525214</p>  <p>H 1 : 182 (mm) OD 1 : 152 (mm) OD 2 : 152 (mm) ID 1 : 45 (mm) ID 2 : 45 (mm)</p> <p>CONT : 6 VOL : 0.038</p>	<p>H-7104</p> <p>Hydraulic Oil Filter Transmission Metal End Cap Element</p> <p>MAN 81.33215.0002</p>  <p>H 1 : 103.7 (mm) H 2 : 97.3 (mm) OD 1 : 68.6 (mm) OD 2 : 68.6 (mm) ID 1 : 33 (mm)</p> <p>CONT : 50 VOL : 0.037</p>
<p>H-6301</p> <p>Hydraulic Oil Filter Metal End Cap Element</p> <p>MASSEY-FERGUSON 2894080-M1 KOMATSU 373-952-178</p>  <p>H 1 : 166.5 (mm) H 2 : 164.5 (mm) OD 1 : 117.5 (mm) OD 2 : 117.5 (mm) ID 1 : 59 (mm) ID 2 : 59 (mm)</p> <p>CONT : 25 VOL : 0.080</p>	<p>H-69030</p> <p>Hydraulic Oil Filter Metal End Cap Element</p> <p>INGERSOLL RAND 57394728</p>  <p>H 1 : 427 (mm) H 2 : 423 (mm) OD 1 : 79 (mm) OD 2 : 79 (mm) ID 1 : 41.8 (mm)</p> <p>CONT : 25 VOL : 0.101</p>	<p>H-7105</p> <p>Hydraulic Oil Filter additional part Metal End Cap Element With Glass Fiber Media</p> <p>VOLVO 14532686 HITACHI 4157882</p>  <p>H 1 : 86 (mm) H 2 : 82.5 (mm) OD 1 : 42.5 (mm) OD 2 : 42.5 (mm) ID 1 : 21.5 (mm)</p> <p>CONT : 50 VOL : 0.012</p>
<p>H-65010</p> <p>Hydraulic Oil Filter Metal End Cap Element</p>  <p>H 1 : 222 (mm) H 2 : 216.5 (mm) OD 1 : 150 (mm) OD 2 : 150 (mm) ID 1 : 85 (mm) ID 2 : 85 (mm)</p> <p>CONT : 9 VOL : 0.068</p>	<p>H-7101</p> <p>Hydraulic Oil Filter Metal End Cap Element</p> <p>VOLVO 14509379</p>  <p>H 1 : 450 (mm) OD 1 : 150 (mm) OD 2 : 150 (mm) ID 1 : 110 (mm) ID 2 : 110 (mm)</p> <p>CONT : 6 VOL : 0.085</p>	<p>H-7106</p> <p>Hydraulic Oil Filter Metal End Cap Element with synthetic media</p> <p>VOLVO 14539482</p>  <p>H 1 : 432.5 (mm) H 2 : 430 (mm) OD 1 : 150 (mm) OD 2 : 150 (mm) ID 1 : 112 (mm) ID 2 : 110 (mm)</p> <p>CONT : 6 VOL : 0.078</p>



Technical Specification

H-7107 Hydraulic Oil Filter Metal End Cap Element with synthetic media

VOLVO 14532086



H 1 : 450 (mm)
OD 1 : 178 (mm)
OD 2 : 178 (mm)
ID 1 : 110 (mm)
ID 2 : 110 (mm)

CONT : 1
VOL : 0.017

H-71160 Hydraulic Oil Filter Power steering Metal End Cap Element

CASE 279294C91
CASE 279294C92
MACK 485GB3160
VOLVO 874487



H 1 : 70 (mm)
H 2 : 68 (mm)
OD 1 : 88 (mm)
OD 2 : 88 (mm)
ID 1 : 37 (mm)
ID 2 : 23 (mm)

CONT : 50
VOL : 0.036

H-7602 Hydraulic Oil Filter Metal End Cap Element

MANITOU 737524
JOHN DEERE FO58437



H 1 : 128.8 (mm)
H 2 : 123 (mm)
OD 1 : 68.6 (mm)
OD 2 : 68.6 (mm)
ID 1 : 33 (mm)

CONT : 25
VOL : 0.023

H-71120 Hydraulic Oil Filter Metal End Cap Element with synthetic media

VOLVO 14532085



H 1 : 450 (mm)
OD 1 : 150 (mm)
OD 2 : 150 (mm)
ID 1 : 110 (mm)
ID 2 : 110 (mm)

CONT : 1
VOL : 0.013

H-71170 Hydraulic Oil Filter Metal End Cap Element with synthetic media

VOLVO VOE11455028



H 1 : 390 (mm)
OD 1 : 126 (mm)
OD 2 : 126 (mm)
ID 1 : 91.6 (mm)
ID 2 : 9 (mm)

CONT : 6
VOL : 0.047

H-76040 Hydraulic Oil Filter Metal End Cap Element With Glass Fiber Media

CASE-IH CNH 1816114
JOHN DEERE TT220735
FAIREY ARLOX TXW8C10
FAIREY ARLOX TXW8CCC10
FAIREY ARLOX TXW8CGDL10



H 1 : 480 (mm)
OD 1 : 126 (mm)
OD 2 : 126 (mm)
ID 1 : 91.6 (mm)
ID 2 : 9 (mm)

CONT : 9
VOL : 0.099

H-71130 Hydraulic Oil Filter Metal End Cap Element

VOLVO 11026936-2
ARLOX TXW8BCC25



H 1 : 390 (mm)
H 2 : 390 (mm)
OD 1 : 126 (mm)
OD 2 : 126 (mm)
ID 1 : 91.6 (mm)
ID 2 : 9 (mm)

CONT : 6
VOL : 0.054

H-71180 Hydraulic Oil Filter Power steering Metal End Cap Element

MERCEDES-BENZ 000 466 29 04
DAF 185 5687
VOLVO 20580233
RENAULT TRUCKS(RVI) 74 20 580 233
ZF 763 160 114 534



H 1 : 149 (mm)
OD 1 : 60 (mm)
OD 2 : 60 (mm)
ID 1 : 17.8 (mm)
ID 2 : 17.8 (mm)

CONT : 25
VOL : 0.020

H-76050 Hydraulic Oil Filter Metal End Cap Element

CASE-IH CNH 3372819R2
EUCLID 62413976
CASE-IH CNH C1050527



H 1 : 480 (mm)
OD 1 : 126 (mm)
OD 2 : 126 (mm)
ID 1 : 91.6 (mm)
ID 2 : 9 (mm)

CONT : 9
VOL : 0.099

H-71140 Hydraulic Oil Filter Metal End Cap Element

VOLVO 6638403
VOLVO 79011572
CASE P250574



H 1 : 260 (mm)
OD 1 : 106 (mm)
OD 2 : 106 (mm)
ID 1 : 72 (mm)
ID 2 : 9.8 (mm)

CONT : 25
VOL : 0.096

H-71190 Hydraulic Oil Filter Metal End Cap Element

VOLVO 11707525
MASSEY-FERGUSON 191855M4



H 1 : 112 (mm)
H 2 : 108 (mm)
OD 1 : 45 (mm)
OD 2 : 45 (mm)
ID 1 : 24.7 (mm)

CONT : 50
VOL : 0.017

H-76060 Hydraulic Oil Filter Metal End Cap Element

JOHN DEERE AR94510



H 1 : 202.6 (mm)
H 2 : 198 (mm)
OD 1 : 117 (mm)
OD 2 : 117 (mm)
ID 1 : 55.5 (mm)
ID 2 : 55.5 (mm)

CONT : 25
VOL : 0.087

H-71150 Hydraulic Oil Filter Metal End Cap Element With Glass Fiber Media

VOLVO 11026934
VOLVO 110269341
VOLVO 110269347



H 1 : 290 (mm)
OD 1 : 126 (mm)
OD 2 : 126 (mm)
ID 1 : 91.6 (mm)
ID 2 : 9 (mm)

CONT : 9
VOL : 0.058

Note : H-85110(Media difference)

H-7601 Hydraulic Oil Filter Metal End Cap Element

JOHN DEERE AR75603



H 1 : 138.6 (mm)
H 2 : 134 (mm)
OD 1 : 117 (mm)
OD 2 : 117 (mm)
ID 1 : 55.5 (mm)
ID 2 : 55.5 (mm)

CONT : 25
VOL : 0.063

H-76070 Hydraulic Oil Filter Metal End Cap Element With Glass Fiber Media

JOHN DEERE AR98098











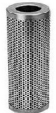





H 1 : 203 (mm)
H 2 : 198 (mm)
OD 1 : 117 (mm)
OD 2 : 117 (mm)
ID 1 : 56 (mm)
ID 2 : 56 (mm)

CONT : 25
VOL : 0.028

















Technical Specification

<p>H-7901 Hydraulic Oil Filter Metal End Cap Element KOMATSU 8257-107</p>  <p>H 1 : 296 (mm) OD 1 : 113.5 (mm) OD 2 : 113.5 (mm) ID 1 : 72.5 (mm) ID 2 : 72.5 (mm)</p> <p>CONT : 20 VOL : 0.103</p>	<p>H-7906 Hydraulic Oil Filter Metal End Cap Element MASSEY-FERGUSON 1662-566M1</p>  <p>H 1 : 72.7 (mm) H 2 : 70.5 (mm) OD 1 : 71 (mm) OD 2 : 71 (mm) ID 1 : 10 (mm) ID 2 : 10 (mm)</p> <p>CONT : 50 VOL : 0.026</p>	<p>H-7913 Hydraulic Oil Filter Metal End Cap Element CATERPILLAR KRJ 5170</p>  <p>H 1 : 254 (mm) H 2 : 250 (mm) OD 1 : 180 (mm) OD 2 : 180 (mm) ID 1 : 136 (mm) ID 2 : 136 (mm)</p> <p>CONT : 9 VOL : 0.103</p>
<p>H-7902 Hydraulic Oil Filter Metal End Cap Element KOMATSU 58673-15100</p>  <p>H 1 : 181.4 (mm) H 2 : 178 (mm) OD 1 : 100 (mm) OD 2 : 100 (mm) ID 1 : 60 (mm) ID 2 : 60 (mm)</p> <p>CONT : 25 VOL : 0.074</p> <p>Note : Paper Band</p>	<p>H-7907 Hydraulic Oil Filter Metal End Cap Element YSK IHI-517006</p>  <p>H 1 : 450 (mm) OD 1 : 113.5 (mm) OD 2 : 113.5 (mm) ID 1 : 72.5 (mm) ID 2 : 72.5 (mm)</p> <p>CONT : 15 VOL : 0.115</p>	<p>H-7914 Hydraulic Oil Filter Metal End Cap Element VOLVO 1529253 TADANO 36670030010 MITSUBISHI 689-38210010 MITSUBISHI 689-38210011</p>  <p>H 1 : 378 (mm) H 2 : 374 (mm) OD 1 : 113 (mm) OD 2 : 113 (mm) ID 1 : 72 (mm) ID 2 : 72 (mm)</p> <p>CONT : 12 VOL : 0.085</p>
<p>H-7903 Hydraulic Oil Filter Metal End Cap Element FURUKAWA 05018-04002</p>  <p>H 1 : 156 (mm) H 2 : 154 (mm) OD 1 : 95.3 (mm) OD 2 : 95.3 (mm) ID 1 : 36.3 (mm) ID 2 : 16.5 (mm)</p> <p>CONT : 25 VOL : 0.046</p>	<p>H-7910 Hydraulic Oil Filter Metal End Cap Element KOMATSU 175-49-11222</p>  <p>H 1 : 195 (mm) OD 1 : 118 (mm) OD 2 : 118 (mm) ID 1 : 88 (mm) ID 2 : 88 (mm)</p> <p>CONT : 9 VOL : 0.035</p>	<p>H-7915 Hydraulic Oil Filter Metal End Cap Element With Glass Fiber Media PALL HC-9600FUP4H</p>  <p>H 1 : 121 (mm) H 2 : 117 (mm) OD 1 : 79 (mm) OD 2 : 79 (mm) ID 1 : 41.8 (mm)</p> <p>CONT : 50 VOL : 0.049</p>
<p>H-7904 Hydraulic Oil Filter Metal End Cap Element HITACHI X4114950</p>  <p>H 1 : 459 (mm) H 2 : 441 (mm) OD 1 : 112 (mm) OD 2 : 112 (mm) ID 1 : 66 (mm) ID 2 : 66 (mm)</p> <p>CONT : 10 VOL : 0.077</p>	<p>H-7911 Hydraulic Oil Filter Metal End Cap Element KOMATSU 07063-01210 KOMATSU 205-60-51430</p>  <p>H 1 : 450 (mm) OD 1 : 150 (mm) OD 2 : 150 (mm) ID 1 : 110 (mm) ID 2 : 110 (mm)</p> <p>CONT : 6 VOL : 0.087</p> <p>Note : Without gasket</p>	<p>H-7916 Hydraulic Oil Filter Metal End Cap Element With Glass Fiber Media PALL HC-9600FUP8H</p>  <p>H 1 : 207 (mm) H 2 : 203 (mm) OD 1 : 79 (mm) OD 2 : 79 (mm) ID 1 : 41.8 (mm)</p> <p>CONT : 25 VOL : 0.054</p>
<p>H-7905 Hydraulic Oil Filter Metal End Cap Element INGERSOLL RAND 35295427 INGERSOLL RAND 35330125 INGERSOLL RAND 35997352</p>  <p>H 1 : 408 (mm) H 2 : 406 (mm) OD 1 : 110 (mm) OD 2 : 110 (mm) ID 1 : 63.5 (mm) ID 2 : 20.5 (mm)</p> <p>CONT : 15 VOL : 0.113</p>	<p>H-7912 Hydraulic Oil Filter Metal End Cap Element HITACHI 3502410-N KOBELCO H 401</p>  <p>H 1 : 291 (mm) H 2 : 277 (mm) OD 1 : 90 (mm) OD 2 : 90 (mm) ID 1 : 46.6 (mm) ID 2 : 46.6 (mm)</p> <p>CONT : 20 VOL : 0.071</p>	<p>H-7917 Hydraulic Oil Filter Metal End Cap Element With Glass Fiber Media PALL HC-9600FUP13</p>  <p>H 1 : 334 (mm) H 2 : 330 (mm) OD 1 : 79 (mm) OD 2 : 79 (mm) ID 1 : 41.8 (mm)</p> <p>CONT : 25 VOL : 0.084</p>



Technical Specification

<p>H-7919</p> <p>Hydraulic Oil Filter Metal End Cap Element</p> <p>KOBELCO 24046Z15</p>  <p>H 1 : 449 (mm) OD 1 : 112 (mm) OD 2 : 112 (mm) ID 1 : 70 (mm) ID 2 : 70 (mm)</p> <p>CONT : 10 VOL : 0.076</p>	<p>H-7929</p> <p>Hydraulic Oil Filter Metal End Cap Element</p> <p>KOMATSU 346271-31110 KOMATSU 600-319-81161</p>  <p>H 1 : 233.4 (mm) H 2 : 228.4 (mm) OD 1 : 110 (mm) OD 2 : 110 (mm) ID 1 : 44 (mm) ID 2 : 44 (mm)</p> <p>CONT : 12 VOL : 0.045</p>	<p>H-7936</p> <p>Hydraulic Oil Filter Metal End Cap Element</p> <p>CASE D43800 CASE D43801</p>  <p>H 1 : 186 (mm) H 2 : 180 (mm) OD 1 : 66 (mm) OD 2 : 66 (mm) ID 1 : 32 (mm)</p> <p>CONT : 50 VOL : 0.053</p>
<p>H-7920</p> <p>Hydraulic Oil Filter Metal End Cap Element</p> <p>KOBELCO H142</p>  <p>H 1 : 253 (mm) H 2 : 249 (mm) OD 1 : 240 (mm) OD 2 : 240 (mm) ID 1 : 178 (mm) ID 2 : 178 (mm)</p> <p>CONT : 4 VOL : 0.080</p>	<p>H-7930</p> <p>Hydraulic Oil Filter Metal End Cap Element</p>  <p>H 1 : 166.5 (mm) H 2 : 158 (mm) OD 1 : 124 (mm) OD 2 : 124 (mm) ID 1 : 59.5 (mm) Thread Size : M10X1.5</p> <p>CONT : 20 VOL : 0.073</p> <p>Note : special product</p>	<p>H-79370</p> <p>Hydraulic Oil Filter Wire Mesh supported Element</p> <p>HELI A22A2-20701</p>  <p>H 1 : 65 (mm) H 2 : 57 (mm) OD 1 : 56 (mm) OD 2 : 56 (mm)</p> <p>CONT : 50 VOL : 0.015</p>
<p>H-7921</p> <p>Hydraulic Oil Filter Metal End Cap Element</p> <p>TAISEI KOGYO U-03</p>  <p>H 1 : 152.5 (mm) H 2 : 148 (mm) OD 1 : 62 (mm) OD 2 : 62 (mm) ID 1 : 31.6 (mm)</p> <p>CONT : 25 VOL : 0.020</p>	<p>H-79330</p> <p>Hydraulic Oil Filter Metal End Cap Element With Glass Fiber Media</p> <p>DAHL 301-CS</p>  <p>H 1 : 246.4 (mm) H 2 : 242 (mm) OD 1 : 155 (mm) OD 2 : 155 (mm) ID 1 : 82 (mm) ID 2 : 36.3 (mm)</p> <p>CONT : 4 VOL : 0.031</p>	<p>H-7938</p> <p>Hydraulic Oil Filter Metal End Cap Element</p> <p>MITSUBISHI 4654430</p>  <p>H 1 : 180 (mm) OD 1 : 114 (mm) OD 2 : 114 (mm) ID 1 : 58 (mm)</p> <p>CONT : 10 VOL : 0.030</p>
<p>H-7922</p> <p>Hydraulic Oil Filter Metal End Cap Element With Glass Fiber Media</p> <p>J.C.BAMFORD 99000090 FAIREY ARLON TXW5AGDL10</p>  <p>H 1 : 465 (mm) OD 1 : 106 (mm) OD 2 : 106 (mm) ID 1 : 72 (mm) ID 2 : 9.8 (mm)</p> <p>CONT : 9 VOL : 0.064</p>	<p>H-79331</p> <p>Hydraulic Oil Filter Metal End Cap Element With Glass Fiber Media</p> <p>DAHL DAHL 301-MPG</p>  <p>H 1 : 246.4 (mm) H 2 : 242 (mm) OD 1 : 155 (mm) OD 2 : 155 (mm) ID 1 : 83 (mm) ID 2 : 36.3 (mm)</p> <p>CONT : 4 VOL : 0.031</p>	<p>H-7939</p> <p>Hydraulic Oil Filter Metal End Cap Element</p> <p>SUMITOMO KTJ 1429</p>  <p>H 1 : 402 (mm) H 2 : 398 (mm) OD 1 : 180.3 (mm) OD 2 : 180.3 (mm) ID 1 : 115 (mm) ID 2 : 115 (mm)</p> <p>CONT : 9 VOL : 0.150</p>
<p>H-7923</p> <p>Hydraulic Oil Filter Element With Glass Fiber Media</p> <p>KOBELCO YN52V01011P1 KOBELCO YN52V01016R100</p>  <p>H 1 : 249 (mm) H 2 : 231 (mm) OD 1 : 144 (mm) OD 2 : 142.5 (mm) ID 1 : 96.5 (mm) ID 2 : 96.5 (mm) Thread Size : 4 7/16"X11G</p> <p>CONT : 12 VOL : 0.080</p>	<p>H-7934</p> <p>Hydraulic Oil Filter Metal End Cap Element</p> <p>KOBELCO 2446U126</p>  <p>H 1 : 163 (mm) H 2 : 158 (mm) OD 1 : 73 (mm) OD 2 : 73 (mm) ID 1 : 34.6 (mm)</p> <p>CONT : 50 VOL : 0.069</p>	<p>H-7940</p> <p>Hydraulic Oil Filter Metal End Cap Element</p> <p>SUMITOMO KRA 0356</p>  <p>H 1 : 85.5 (mm) H 2 : 82 (mm) OD 1 : 42 (mm) OD 2 : 42 (mm) ID 1 : 24 (mm)</p> <p>CONT : 50 VOL : 0.011</p>



Technical Specification

H-7941 Hydraulic Oil Filter Metal End Cap Element

MERCEDES-BENZ 15H624
BELL 220005
CATERPILLAR 311894



H 1 : 176 (mm)
OD 1 : 113.8 (mm)
OD 2 : 113.8 (mm)
ID 1 : 44.7 (mm)
ID 2 : 44.7 (mm)

CONT : 10
VOL : 0.031

Note : without gasket

H-79510 Hydraulic Oil Filter Metal End Cap Element



H 1 : 372 (mm)
H 2 : 361 (mm)
OD 1 : 98 (mm)
OD 2 : 98 (mm)
ID 1 : 53 (mm)

CONT : 25
VOL : 0.103

H-7960 Hydraulic Oil Filter Wire Mesh supported Element

HITACHI 45775779-1



H 1 : 83 (mm)
H 2 : 78 (mm)
OD 1 : 62 (mm)
OD 2 : 62 (mm)
ID 1 : 31 (mm)

CONT : 25
VOL : 0.013

H-79411 Hydraulic Oil Filter Metal End Cap Element

MASSEY-FERGUSON 1022883M1
CATERPILLAR 32-9868
MASSEY-FERGUSON 577492M91



H 1 : 176 (mm)
OD 1 : 113.8 (mm)
OD 2 : 113.8 (mm)
ID 1 : 44.7 (mm)
ID 2 : 44.7 (mm)

CONT : 10
VOL : 0.031

Note : with gaskets on end cap

H-7952 Hydraulic Oil Filter Metal End Cap Element

TCM 23457-52221



H 1 : 135.6 (mm)
H 2 : 134 (mm)
OD 1 : 58.5 (mm)
OD 2 : 59 (mm)
ID 1 : 29 (mm)
ID 2 : 12 (mm)

CONT : 25
VOL : 0.015

H-7961 Hydraulic Oil Filter Metal End Cap Element

CLARK 244530
FIAT 710049229
CATERPILLAR 814232



H 1 : 142 (mm)
H 2 : 140 (mm)
OD 1 : 88 (mm)
OD 2 : 88 (mm)
ID 1 : 28.8 (mm)

CONT : 25
VOL : 0.045

H-7942 Hydraulic Oil Filter Metal End Cap Element

CATERPILLAR 126-2081
CATERPILLAR 126-2081X



H 1 : 418 (mm)
H 2 : 415.5 (mm)
OD 1 : 142 (mm)
OD 2 : 142 (mm)
ID 1 : 97.4 (mm)
ID 2 : 97.4 (mm)

CONT : 6
VOL : 0.068

H-7956 Hydraulic Oil Filter Element

KUBOTA 68651-62120



H 1 : 201 (mm)
H 2 : 184 (mm)
OD 1 : 90 (mm)
OD 2 : 90 (mm)
Thread Size : 1X11 BSPT

CONT : 25
VOL : 0.054

H-7962 Hydraulic Oil Filter Metal End Cap Element

HITACHI 4156753



H 1 : 459 (mm)
H 2 : 443 (mm)
OD 1 : 112 (mm)
OD 2 : 112 (mm)
ID 1 : 69 (mm)
ID 2 : 69 (mm)

CONT : 10
VOL : 0.080

H-7946 Hydraulic Oil Filter Wire Mesh supported Element

KOMATSU 34B-66-15180



H 1 : 124.5 (mm)
H 2 : 95.5 (mm)
OD 1 : 70.3 (mm)
OD 2 : 63 (mm)
ID 1 : 40.6 (mm)

CONT : 25
VOL : 0.019

Note : Nut, E/C Aluminium casting

H-7958 Hydraulic Oil Filter Metal End Cap Element

TAKEUCHI 15511-00803



H 1 : 138 (mm)
H 2 : 134 (mm)
OD 1 : 76.5 (mm)
OD 2 : 76.5 (mm)
ID 1 : 35 (mm)

CONT : 50
VOL : 0.060

H-7963 Hydraulic Oil Filter Suction Element

CATERPILLAR 7Y-4748



H 1 : 138.5 (mm)
H 2 : 132 (mm)
OD 1 : 150 (mm)
OD 2 : 150 (mm)
ID 1 : 73.4 (mm)
Thread Size : M10X1.5

CONT : 9
VOL : 0.043

Note : for Caterpillar E200B, Komatsu PC120-3

H-7950 Hydraulic Oil Filter Element

MITSUBISHI 91276-12600



H 1 : 110.5 (mm)
H 2 : 96 (mm)
OD 1 : 79 (mm)
OD 2 : 79 (mm)
Thread Size : 1 1/4"X11 UNF

CONT : 25
VOL : 0.023

H-7959 Hydraulic Oil Filter Metal End Cap Element

KOMATSU 201-60-65210



H 1 : 176.5 (mm)
OD 1 : 110 (mm)
OD 2 : 110 (mm)
ID 1 : 59 (mm)
Thread Size : M10X1.5

CONT : 25
VOL : 0.076

H-79631 Hydraulic Oil Filter Suction Element



H 1 : 138.5 (mm)
H 2 : 132 (mm)
OD 1 : 150 (mm)
OD 2 : 150 (mm)
ID 1 : 73.4 (mm)
Thread Size : M10X1.5

CONT : 9
VOL : 0.040

Note : for Caterpillar E200B, Komatsu PC120-3



Technical Specification

H-7965 Hydraulic Oil Filter Element

MITSUBISHI 91375-13600



H 1 : 94 (mm)
H 2 : 78 (mm)
OD 1 : 100 (mm)
OD 2 : 100 (mm)
Thread Size : 1 1/4"X11 UNF

CONT : 20
VOL : 0.026

H-7974 Hydraulic Oil Filter Metal End Cap Element With Glass Fiber Media

PALL HC9600FDN4H
PALL HC9600FKN4H
PALL HC9600FUN4H



H 1 : 116.5 (mm)
H 2 : 112.5 (mm)
OD 1 : 79 (mm)
OD 2 : 79 (mm)
ID 1 : 41.8 (mm)

CONT : 25
VOL : 0.025

H-79781 Hydraulic Oil Filter Metal End Cap Element With Glass Fiber Media

TAKEUCHI 15511-02501



H 1 : 208.5 (mm)
H 2 : 204 (mm)
OD 1 : 51 (mm)
OD 2 : 51 (mm)
ID 1 : 23.5 (mm)

CONT : 25
VOL : 0.019

Note : Synthetic media version

H-7969 Hydraulic Oil Filter Metal End Cap Element

KOBELCO 2446R330F1
VOLVO VOE1141-00010



H 1 : 95 (mm)
H 2 : 89 (mm)
OD 1 : 200 (mm)
OD 2 : 200 (mm)
ID 1 : 96.6 (mm)
Thread Size : M10X1.5

CONT : 8
VOL : 0.042

H-7975 Hydraulic Oil Filter Metal End Cap Element With Glass Fiber Media

MASSEY-FERGUSON 3902287M1
WHITE 3902287M1
PALL HC9600FKT8H
PALL HC9600FUT8H



H 1 : 207 (mm)
H 2 : 203 (mm)
OD 1 : 79 (mm)
OD 2 : 79 (mm)
ID 1 : 41.8 (mm)

CONT : 25
VOL : 0.054

H-7979 Hydraulic Oil Filter Metal End Cap Element

KOBELCO H-141
SUMITOMO KSJ-0011



H 1 : 304 (mm)
H 2 : 300 (mm)
OD 1 : 180 (mm)
OD 2 : 180 (mm)
ID 1 : 136 (mm)
ID 2 : 136 (mm)

CONT : 9
VOL : 0.124

H-7970 Hydraulic Oil Filter Metal End Cap Element

KOBELCO YR50V00006F2P



H 1 : 451 (mm)
H 2 : 449 (mm)
OD 1 : 112 (mm)
OD 2 : 112 (mm)
ID 1 : 70 (mm)
ID 2 : 70 (mm)

CONT : 10
VOL : 0.077

H-7976 Hydraulic Oil Filter Metal End Cap Element

TEREX 15267046
FIAT-ALLIS 70197878



H 1 : 235 (mm)
H 2 : 230 (mm)
OD 1 : 99 (mm)
OD 2 : 99 (mm)
ID 1 : 40.5 (mm)
ID 2 : 40.5 (mm)

CONT : 20
VOL : 0.074

H-7980 Hydraulic Oil Filter Metal End Cap Element

KOBELCO H-143



H 1 : 75 (mm)
OD 1 : 60 (mm)
OD 2 : 60 (mm)
ID 1 : 22.6 (mm)

CONT : 25
VOL : 0.013

H-7972 Hydraulic Oil Filter Metal End Cap Element With Glass Fiber Media

FAIREY ARLON 370L110A
FAIREYAR 370L123A
FAIREYAR 370L123GDH20
CATERPILLAR 3I1955



H 1 : 101.5 (mm)
H 2 : 94.5 (mm)
OD 1 : 93 (mm)
OD 2 : 93 (mm)
ID 1 : 47 (mm)

CONT : 25
VOL : 0.030

H-7977 Hydraulic Oil Filter Metal End Cap Element

SUMITOMO LS2800



H 1 : 307 (mm)
H 2 : 301 (mm)
OD 1 : 150 (mm)
OD 2 : 150 (mm)
ID 1 : 110 (mm)
ID 2 : 110 (mm)

CONT : 4
VOL : 0.038

H-7981 Hydraulic Oil Filter Return Metal End Cap Element

HITACHI 4443773
HITACHI 4448402



H 1 : 433 (mm)
OD 1 : 156 (mm)
OD 2 : 150 (mm)
ID 1 : 98 (mm)

CONT : 6
VOL : 0.081

Note : BPV=1.5 kgf/cm²

H-7973 Hydraulic Oil Filter Metal End Cap Element With Glass Fiber Media

J.C.BAMFORD 58106301



H 1 : 300 (mm)
OD 1 : 72 (mm)
OD 2 : 72 (mm)
ID 1 : 45 (mm)
ID 2 : 7.5 (mm)

CONT : 25
VOL : 0.049

H-7978 Hydraulic Oil Filter Metal End Cap Element

TAKEUCHI 15511-02501



H 1 : 209.5 (mm)
H 2 : 204 (mm)
OD 1 : 51 (mm)
OD 2 : 55 (mm)
ID 1 : 23 (mm)

CONT : 25
VOL : 0.023

H-7982 Hydraulic Oil Filter Metal End Cap Element

PMITALY 149046

















H 1 : 208 (mm)
H 2 : 204 (mm)
OD 1 : 51 (mm)
OD 2 : 51 (mm)
ID 1 : 23 (mm)

CONT : 50
VOL : 0.037



Technical Specification

<p>H-7983</p> <p>Hydraulic Oil Filter Metal End Cap Element</p> <p>TEREX 4008687 CLARK 888331</p>  <p>H 1 : 204.5 (mm) OD 1 : 152 (mm) OD 2 : 152 (mm) ID 1 : 89 (mm) ID 2 : 89 (mm)</p> <p>CONT : 12 VOL : 0.070</p>	<p>H-7987</p> <p>Hydraulic Oil Filter Element</p> <p>TAKEUCHI 15511-01910</p>  <p>H 1 : 310 (mm) H 2 : 280 (mm) OD 1 : 90 (mm) OD 2 : 90 (mm) ID 1 : 41.5 (mm) Thread Size : 1 1/4X13G</p> <p>CONT : 25 VOL : 0.096</p>	<p>H-7992</p> <p>Hydraulic Oil Filter Metal End Cap Element</p>  <p>H 1 : 197.5 (mm) OD 1 : 110 (mm) OD 2 : 110 (mm) ID 1 : 34 (mm)</p> <p>CONT : 12 VOL : 0.044</p> <p>Note : special product</p>
<p>H-7984</p> <p>Hydraulic Oil Filter Metal End Cap Element</p> <p>KOBELCO SK300</p>  <p>H 1 : 140.5 (mm) H 2 : 128.5 (mm) OD 1 : 200 (mm) OD 2 : 200 (mm) ID 1 : 134 (mm) Thread Size : M10X1.5</p> <p>CONT : 4 VOL : 0.034</p>	<p>H-7988</p> <p>Hydraulic Oil Filter Metal End Cap Element</p> <p>SCHROEDER BB10</p>  <p>H 1 : 460 (mm) OD 1 : 127 (mm) OD 2 : 127 (mm) ID 1 : 82.75 (mm) ID 2 : 82.75 (mm)</p> <p>CONT : 20 VOL : 0.197</p>	<p>H-7995</p> <p>Hydraulic Oil Filter Metal End Cap Element</p> <p>YALE & TOWNE 917380400</p>  <p>H 1 : 196.8 (mm) H 2 : 180 (mm) OD 1 : 90 (mm) OD 2 : 90 (mm) Thread Size : 1X11 BSPT</p> <p>CONT : 25 VOL : 0.059</p>
<p>H-7985</p> <p>Hydraulic Oil Filter Metal End Cap Element</p> <p>INGERSOLL RAND 50343490</p>  <p>H 1 : 235 (mm) H 2 : 230 (mm) OD 1 : 99 (mm) OD 2 : 99 (mm) ID 1 : 40.5 (mm) ID 2 : 40.5 (mm)</p> <p>CONT : 20 VOL : 0.056</p>	<p>H-7989</p> <p>Hydraulic Oil Filter Metal End Cap Element</p> <p>SCHROEDER CC3/9C3</p>  <p>H 1 : 240 (mm) H 2 : 235.5 (mm) OD 1 : 73 (mm) OD 2 : 73 (mm) ID 1 : 26 (mm)</p> <p>CONT : 20 VOL : 0.040</p>	<p>H-7996</p> <p>Hydraulic Oil Filter Transmission Metal End Cap Element</p> <p>ALLISON 29501202 ALLISON 29501202C</p>  <p>H 1 : 107 (mm) OD 1 : 76 (mm) OD 2 : 76 (mm) ID 1 : 37 (mm)</p> <p>CONT : 50 VOL : 0.040</p> <p>Note : Uses 2 filters per application</p>
<p>H-7986</p> <p>Hydraulic Oil Filter Metal End Cap Element Cellulose media</p> <p>TAKEUCHI 15511-00200 KOBELCO 2446R336F1 KOBELCO PH50V00005F1</p>  <p>H 1 : 296 (mm) H 2 : 292 (mm) OD 1 : 112 (mm) OD 2 : 112 (mm) ID 1 : 70 (mm) ID 2 : 70 (mm)</p> <p>CONT : 25 VOL : 0.123</p> <p>Note : with glassfiber media version uses H-79861</p>	<p>H-7990</p> <p>Hydraulic Oil Filter Metal End Cap Element</p> <p>FIAT 7295093 FIAT 72950937 HITACHI PM 50V00012F1</p>  <p>H 1 : 156.5 (mm) OD 1 : 82.5 (mm) OD 2 : 82.5 (mm) ID 1 : 41 (mm) ID 2 : 41 (mm)</p> <p>CONT : 25 VOL : 0.034</p>	<p>H-7997</p> <p>Hydraulic Oil Filter Metal End Cap Element With Glass Fiber Media</p> <p>ALLISON 29509723 ALLISON 29509723A ALLISON 29509723B ALLISON 29509723C</p>  <p>H 1 : 151 (mm) OD 1 : 76 (mm) OD 2 : 76 (mm) ID 1 : 37 (mm)</p> <p>CONT : 50 VOL : 0.056</p>
<p>H-79861</p> <p>Hydraulic Oil Filter Metal End Cap Element With Glass Fiber Media</p> <p>TAKEUCHI 15511-03900 YANMAR 172B11-73710</p>  <p>H 1 : 294.5 (mm) H 2 : 290.5 (mm) OD 1 : 112 (mm) OD 2 : 112 (mm) ID 1 : 70 (mm) ID 2 : 70 (mm)</p> <p>CONT : 12 VOL : 0.062</p> <p>Note : Cellulose media version uses H-7986</p>	<p>H-7991</p> <p>Hydraulic Oil Filter Metal End Cap Element</p> <p>AHLMANN 4197591A ARGO P2-0933-01</p>  <p>H 1 : 329 (mm) OD 1 : 89 (mm) OD 2 : 89 (mm) ID 1 : 50 (mm) ID 2 : 50 (mm)</p> <p>CONT : 9 VOL : 0.028</p>	<p>H-7998</p> <p>Hydraulic Oil Filter Metal End Cap Element</p> <p>SAKAI 4201-02000-0</p>  <p>H 1 : 301 (mm) H 2 : 299 (mm) OD 1 : 148.5 (mm) OD 2 : 148.5 (mm) ID 1 : 84 (mm)</p> <p>CONT : 4 VOL : 0.036</p>



Technical Specification

H-7999 Hydraulic Oil Filter Metal End Cap Element With Glass Fiber Media
CASE 93413C1



H 1 : 76.5 (mm)
H 2 : 75.5 (mm)
OD 1 : 127 (mm)
OD 2 : 127 (mm)
ID 1 : 76 (mm)
ID 2 : 76 (mm)

CONT : 18
VOL : 0.029

H-85110 Hydraulic Oil Filter Metal End Cap Element
CATERPILLAR 312140



H 1 : 291 (mm)
OD 1 : 126 (mm)
OD 2 : 126 (mm)
ID 1 : 91.6 (mm)
ID 2 : 9 (mm)

CONT : 9
VOL : 0.062

Note : H-71150(Media difference)

H-8519 Hydraulic Oil Filter Element With Glass Fiber Media
IVECO 29538232E



H 1 : 152 (mm)
H 2 : 149 (mm)
OD 1 : 81.5 (mm)
OD 2 : 81.5 (mm)
ID 1 : 37 (mm)

CONT : 25
VOL : 0.036

H-8301 Hydraulic Oil Filter Metal End Cap Element
SAAB-SCANIA 1329876
SAAB-SCANIA 1381235



H 1 : 107 (mm)
H 2 : 104 (mm)
OD 1 : 84 (mm)
OD 2 : 84 (mm)
ID 1 : 20 (mm)

CONT : 50
VOL : 0.047

H-8515 Hydraulic Oil Filter Metal End Cap Element
TORO 013170140
HIAB 9961941
FAIREY ARLON TX310



H 1 : 150 (mm)
OD 1 : 72 (mm)
OD 2 : 72 (mm)
ID 1 : 51 (mm)
ID 2 : 7.5 (mm)

CONT : 50
VOL : 0.050

H-8521 Hydraulic Oil Filter Wire Mesh supported Element
TCM 12403-82521



H 1 : 80 (mm)
OD 1 : 59 (mm)
OD 2 : 50 (mm)
ID 1 : 25.5 (mm)

CONT : 50
VOL : 0.044

H-8302 Hydraulic Oil Filter Element
TCM 214A7-52081



H 1 : 184 (mm)
H 2 : 148.5 (mm)
OD 1 : 88 (mm)
OD 2 : 83.5 (mm)
Thread Size : 1 3/8 X 12 UNF

CONT : 25
VOL : 0.045

H-8516 Hydraulic Oil Filter Metal End Cap Element
KOBELCO YN57V000025010H



H 1 : 50.5 (mm)
H 2 : 47 (mm)
OD 1 : 42.5 (mm)
OD 2 : 42.5 (mm)
ID 1 : 21.5 (mm)

CONT : 100
VOL : 0.014

H-8522 Hydraulic Oil Filter Suction Wire Mesh supported Element
TOYOTA 67501-23320-71



H 1 : 112 (mm)
H 2 : 96.5 (mm)
OD 1 : 87 (mm)
OD 2 : 79 (mm)
Thread Size : 1-11 BSPT

CONT : 25
VOL : 0.033

H-8401 Hydraulic Oil Filter Metal End Cap Element
J.C.BAMFORD 581/01801



H 1 : 349 (mm)
OD 1 : 174 (mm)
OD 2 : 174 (mm)
ID 1 : 94 (mm)
ID 2 : 94 (mm)

CONT : 1
VOL : 0.013

H-8517 Hydraulic Oil Filter Element
RENAULT 14057403004400



H 1 : 115 (mm)
H 2 : 102 (mm)
OD 1 : 64 (mm)
OD 2 : 63 (mm)
Thread Size : 3/4X14 BSPT

CONT : 50
VOL : 0.033

H-8523 Hydraulic Oil Filter Plastic Element Synthetic Media
KOBELCO FZ1F180K001A
KOBELCO YN52V01011P2
KOBELCO YN52V01013P1



H 1 : 129 (mm)
H 2 : 111 (mm)
OD 1 : 144 (mm)
OD 2 : 142.5 (mm)
ID 1 : 96.5 (mm)
ID 2 : 96.5 (mm)
Top Thread Size : 4 7/16"X11G
Bottom Thread Size : 4 7/16"X11G

CONT : 18
VOL : 0.064

Note : Element Kit version uses H-4101

H-8502 Hydraulic Oil Filter Metal End Cap Element
SUMITOMO KSJ-1929



H 1 : 333 (mm)
H 2 : 329 (mm)
OD 1 : 180.3 (mm)
OD 2 : 180.3 (mm)
ID 1 : 115 (mm)
ID 2 : 115 (mm)

CONT : 9
VOL : 0.129

H-8518 Hydraulic Oil Filter Wire Mesh supported Element
DAE KEE 2423-6005



H 1 : 143.6 (mm)
H 2 : 136.5 (mm)
OD 1 : 90 (mm)
OD 2 : 90 (mm)
ID 1 : 47 (mm)
Thread Size : M10X1.5

CONT : 50
VOL : 0.076

H-85231 Hydraulic Oil Filter Plastic Element Synthetic Media
KOBELCO FZ1F180K001A
KOBELCO YN52V01011P1
KOBELCO YN52V01011P2
KOBELCO YN52V01013P1
KOBELCO YV52V01003R110



H 1 : 129 (mm)
H 2 : 111 (mm)
OD 1 : 144 (mm)
OD 2 : 142.5 (mm)
ID 1 : 96.5 (mm)
ID 2 : 96.5 (mm)

CONT : 18
VOL : 0.066

Note : With Packing Set 5 PCS



Technical Specification

H-85232 Hydraulic Oil Filter Aluminium Casting Element Synthetic Media

KOBELCO FZ1F180K001A
KOBELCO YN52V01011P1
KOBELCO YN52V01011P2
KOBELCO YN52V01013P1
KOBELCO YV52V01003R110



H 1 : 130 (mm)
H 2 : 110.5 (mm)
OD 1 : 145 (mm)
OD 2 : 145 (mm)
ID 1 : 96.5 (mm)
ID 2 : 96.5 (mm)
Thread Size : 4 7/16"X11 G

CONT : 18
VOL : 0.066

Note : Aluminium version from H-85231

H-8537 Hydraulic Oil Filter Transmission Element With Glass Fiber Media

ALLISON 29506337
ALLISON 29509723C



H 1 : 151 (mm)
H 2 : 148 (mm)
OD 1 : 81.5 (mm)
OD 2 : 81.5 (mm)
ID 1 : 37 (mm)

CONT : 36
VOL : 0.050

H-8541 Hydraulic Oil Filter Metal End Cap Element

INGERSOLL RAND FC1093R010BS



H 1 : 520 (mm)
OD 1 : 106 (mm)
OD 2 : 106 (mm)
ID 1 : 72 (mm)
ID 2 : 9.8 (mm)

CONT : 9
VOL : 0.077

H-85235 Hydraulic Oil Filter Aluminium Casting Element

KOBELCO FZ1F180K001A
KOBELCO YN52V01011P2
KOBELCO YN52V01013P1
NEW HOLLAND (CNH)
YN52V01021P1



H 1 : 130 (mm)
H 2 : 110.5 (mm)
OD 1 : 145 (mm)
OD 2 : 145 (mm)
ID 1 : 96.5 (mm)
ID 2 : 96.5 (mm)
Top Thread Size : 4 7/16"X11 G
Bottom Thread Size : 4 7/16"X11 G

CONT : 18
VOL : 0.066

Note : Aluminium version from H-8523

H-8537-S Hydraulic Oil Filter Transmission Element With Glass Fiber Media

ALLISON 29545779
ALLISON 29548988



H 1 : 151 (mm)
H 2 : 148 (mm)
OD 1 : 81.5 (mm)
OD 2 : 81.5 (mm)
ID 1 : 37 (mm)

CONT : 20
VOL : 0.063

H-8542 Hydraulic Oil Filter Element With Glass Fiber Media

FAIREY ARLON 270-L-123



H 1 : 102.8 (mm)
H 2 : 96 (mm)
OD 1 : 73 (mm)
OD 2 : 73 (mm)
ID 1 : 31.7 (mm)

CONT : 50
VOL : 0.037

H-8525 Hydraulic Oil Filter Element

CATERPILLAR 9127515500



H 1 : 87 (mm)
H 2 : 79.5 (mm)
OD 1 : 79 (mm)
OD 2 : 79 (mm)
Thread Size : 3/4X14 BSP

CONT : 50
VOL : 0.040

H-8538 Hydraulic Oil Filter Transmission Element

ALLISON 29501202
FRAM C9243



H 1 : 107 (mm)
H 2 : 104 (mm)
OD 1 : 81.5 (mm)
OD 2 : 81.5 (mm)
ID 1 : 37 (mm)

CONT : 50
VOL : 0.048

H-8543 Hydraulic Oil Filter Wire Mesh supported Element

HUAKONG HY6252



H 1 : 137 (mm)
H 2 : 131 (mm)
OD 1 : 124 (mm)
OD 2 : 124 (mm)
ID 1 : 73.4 (mm)
Thread Size : M10X1.5

CONT : 18
VOL : 0.055

Note : Applicable machine model EX120

H-8526 Hydraulic Oil Filter Element

TOYOTA 67501-32880-71
TOYOTA 67501-32881-71



H 1 : 116 (mm)
H 2 : 98 (mm)
OD 1 : 99 (mm)
OD 2 : 99 (mm)
Thread Size : 1 1/4"X11 BSPT

CONT : 25
VOL : 0.040

H-8538-S Hydraulic Oil Filter Transmission Element

ALLISON 29501202



H 1 : 107 (mm)
H 2 : 104 (mm)
OD 1 : 81.5 (mm)
OD 2 : 81.5 (mm)
ID 1 : 37 (mm)

CONT : 20
VOL : 0.054

H-8544 Hydraulic Oil Filter Wire Mesh supported Element

HUAKONG HY6450
SUMITOMO SH120



H 1 : 96 (mm)
H 2 : 90 (mm)
OD 1 : 150 (mm)
OD 2 : 150 (mm)
ID 1 : 73.4 (mm)
Thread Size : M10X1.5

CONT : 12
VOL : 0.032

H-8535 Hydraulic Oil Filter Element With Glass Fiber Media

FACET 1742558



H 1 : 342.3 (mm)
H 2 : 326 (mm)
OD 1 : 80.5 (mm)
OD 2 : 80.5 (mm)
ID 1 : 34 (mm)
ID 2 : 24.7 (mm)

CONT : 10
VOL : 0.037

H-8539 Hydraulic Oil Filter Metal End Cap Element With Glass Fiber Media

WESTERN FILTER 200003-1



H 1 : 116.5 (mm)
H 2 : 112.5 (mm)
OD 1 : 79 (mm)
OD 2 : 79 (mm)
ID 1 : 42 (mm)
ID 2 : 42 (mm)

CONT : 25
VOL : 0.027

H-8545 Hydraulic Oil Filter Wire Mesh supported Element

SUNFIELD SP861

















H 1 : 138 (mm)
H 2 : 131 (mm)
OD 1 : 150 (mm)
OD 2 : 150 (mm)
ID 1 : 114.5 (mm)
Thread Size : M10X1.5

CONT : 18
VOL : 0.085



Technical Specification

<p>H-8546</p> <p>Hydraulic Oil Filter Metal End Cap Element</p> <p>MANITOU 744789</p>  <p>H 1 : 203.25 (mm) H 2 : 200 (mm) OD 1 : 50 (mm) OD 2 : 50 (mm) ID 1 : 26 (mm) ID 2 : 7.5 (mm)</p> <p>CONT : 25 VOL : 0.019</p>	<p>H-85521</p> <p>Hydraulic Oil Filter Metal End Cap Element</p> <p>TIMBERJACK 894423</p>  <p>H 1 : 134 (mm) H 2 : 129 (mm) OD 1 : 70 (mm) OD 2 : 70 (mm) ID 1 : 29 (mm) ID 2 : 13.5 (mm)</p> <p>CONT : 50 VOL : 0.059</p> <p>Note : H-85520(Media difference)</p>	<p>H-85590</p> <p>Hydraulic Oil Filter Metal End Cap Element with synthetic media</p> <p>SANY A222100000119</p>  <p>H 1 : 79 (mm) H 2 : 76 (mm) OD 1 : 46 (mm) OD 2 : 46 (mm) ID 1 : 15.5 (mm)</p> <p>CONT : 50 VOL : 0.016</p>
<p>H-8547</p> <p>Hydraulic Oil Filter Metal End Cap Element</p> <p>MANITOU 15511-02103</p>  <p>H 1 : 137.8 (mm) H 2 : 132 (mm) OD 1 : 68.6 (mm) OD 2 : 68.6 (mm) ID 1 : 33.5 (mm)</p> <p>CONT : 50 VOL : 0.047</p>	<p>H-85550</p> <p>Hydraulic Oil Filter Metal End Cap Element</p> <p>MANITOU 109565</p>  <p>H 1 : 84 (mm) H 2 : 83 (mm) OD 1 : 38 (mm) OD 2 : 38 (mm) ID 1 : 30 (mm) ID 2 : 30 (mm)</p> <p>CONT : 100 VOL : 0.019</p>	<p>H-85600</p> <p>Hydraulic Oil Filter Metal End Cap Element with synthetic media</p>  <p>H 1 : 466 (mm) OD 1 : 135 (mm) OD 2 : 135 (mm) ID 1 : 98 (mm)</p> <p>CONT : 1 VOL : 0.010</p>
<p>H-85480</p> <p>Hydraulic Oil Filter Element</p> <p>HYSTER 2021933</p>  <p>H 1 : 165.8 (mm) H 2 : 149.5 (mm) OD 1 : 90 (mm) OD 2 : 90 (mm) Thread Size : 3/4X14 NPT</p> <p>CONT : 25 VOL : 0.048</p>	<p>H-85560</p> <p>Hydraulic Oil Filter Metal End Cap Element with synthetic media</p> <p>VOLVO 11026932 VOLVO 110269321 TAMROCK 86727289 CASE 87353685</p>  <p>H 1 : 290 (mm) OD 1 : 126 (mm) OD 2 : 126 (mm) ID 1 : 91.6 (mm) ID 2 : 9 (mm)</p> <p>CONT : 6 VOL : 0.040</p>	<p>H-85610</p> <p>Hydraulic Oil Filter Metal End Cap Element With Glass Fiber Media</p>  <p>H 1 : 587 (mm) OD 1 : 135 (mm) OD 2 : 135 (mm) ID 1 : 98 (mm)</p> <p>CONT : 6 VOL : 0.081</p>
<p>H-85490</p> <p>Hydraulic Oil Filter Suction Element</p> <p>HANGCHA 70022095 HANGCHA N163-603400-000</p>  <p>H 1 : 123 (mm) H 2 : 82 (mm) OD 1 : 139.5 (mm) OD 2 : 101 (mm) ID 1 : 22.5 (mm)</p> <p>CONT : 18 VOL : 0.054</p>	<p>H-85570</p> <p>Hydraulic Oil Filter Metal End Cap Element with synthetic media</p> <p>DOOSAN K9005928</p>  <p>H 1 : 450 (mm) OD 1 : 150 (mm) OD 2 : 150 (mm) ID 1 : 110 (mm) ID 2 : 110 (mm)</p> <p>CONT : 1 VOL : 0.013</p>	<p>H-85630</p> <p>Hydraulic Oil Filter Metal End Cap Element</p>  <p>H 1 : 400 (mm) OD 1 : 117 (mm) OD 2 : 117 (mm) ID 1 : 61 (mm) ID 2 : 61 (mm)</p> <p>CONT : 6 VOL : 0.041</p>
<p>H-85520</p> <p>Hydraulic Oil Filter Metal End Cap Element</p> <p>SCANIA 135 4074 LIEBHERR 5106143 LIEBHERR 510614308 MAN 81.06668.0006</p>  <p>H 1 : 134 (mm) H 2 : 129 (mm) OD 1 : 70 (mm) OD 2 : 70 (mm) ID 1 : 29 (mm) ID 2 : 13.5 (mm)</p> <p>CONT : 50 VOL : 0.059</p>	<p>H-85580</p> <p>Hydraulic Oil Filter Metal End Cap Element</p> <p>DOOSAN K9005929</p>  <p>H 1 : 450 (mm) OD 1 : 178 (mm) OD 2 : 178 (mm) ID 1 : 110 (mm) ID 2 : 110 (mm)</p> <p>CONT : 1 VOL : 0.016</p>	<p>H-85640</p> <p>Hydraulic Oil Filter Metal End Cap Element</p> <p>H 1 : 296 (mm) OD 1 : 118 (mm) ID 1 : 88 (mm)</p> <p>CONT : 6 VOL : 0.030</p> <p>Note : special product</p>



Technical Specification

H-85650 Hydraulic Oil Filter Metal End Cap Element



H 1 : 323 (mm)
OD 1 : 112 (mm)
OD 2 : 112 (mm)
ID 1 : 82 (mm)

CONT : 6
VOL : 0.031

Note : special product

H-85720 Hydraulic Oil Filter Metal End Cap Element with synthetic media

GUANGXI LIUGONG MACHINERY
53C0011
XGMA 53C0011



H 1 : 293 (mm)
OD 1 : 120 (mm)
OD 2 : 120 (mm)
ID 1 : 68.7 (mm)
ID 2 : 68.7 (mm)

CONT : 1
VOL : 0.005

H-85790 Hydraulic Oil Filter Metal End Cap Element



H 1 : 226.7 (mm)
H 2 : 225 (mm)
OD 1 : 80 (mm)
OD 2 : 80 (mm)
ID 1 : 50.8 (mm)
ID 2 : 5 (mm)

CONT : 25
VOL : 0.050

Note : for hydraulic oil tank

H-85670 Hydraulic Oil Filter Metal End Cap Element

GUANGXI LIUGONG MACHINERY
53C0035



H 1 : 280 (mm)
H 2 : 275 (mm)
OD 1 : 120 (mm)
OD 2 : 120 (mm)
ID 1 : 80 (mm)

CONT : 6
VOL : 0.032

H-85730 Hydraulic Oil Filter Metal End Cap Element with synthetic media

GUANGXI LIUGONG MACHINERY
53C0250



H 1 : 83.5 (mm)
Not Available : 78 (mm)
OD 1 : 47 (mm)
OD 2 : 47 (mm)
ID 1 : 21 (mm)

CONT : 12
VOL : 0.005

H-85800 Hydraulic Oil Filter Metal End Cap Element

SAKAI 4207-7900-00



H 1 : 130 (mm)
H 2 : 119 (mm)
OD 1 : 90 (mm)
OD 2 : 90 (mm)
Thread Size : 1"X11 BSPT

CONT : 12
VOL : 0.021

H-85680 Hydraulic Oil Filter Metal End Cap Element

SUMITOMO KRJ15830
SUMITOMO KRJ20710



H 1 : 454 (mm)
H 2 : 449 (mm)
OD 1 : 150 (mm)
OD 2 : 150 (mm)
ID 1 : 110 (mm)
ID 2 : 110 (mm)

CONT : 1
VOL : 0.013

H-85750 Hydraulic Oil Filter Metal End Cap Element

HAMM (WIRTEGNGROUP) 1285491



H 1 : 241 (mm)
OD 1 : 73.5 (mm)
OD 2 : 79 (mm)
ID 1 : 32 (mm)

CONT : 25
VOL : 0.045

H-85810 Hydraulic Oil Filter Metal End Cap Element

SUNWARD 730403000139



H 1 : 286 (mm)
H 2 : 281 (mm)
OD 1 : 180 (mm)
OD 2 : 180 (mm)
ID 1 : 85 (mm)

CONT : 1
VOL : 0.012

Note : for SUNWARD EXCAVATOR

H-85700 Hydraulic Oil Filter Metal End Cap Element

GUANGXI LIUGONG MACHINERY
53C0006



H 1 : 539 (mm)
H 2 : 534 (mm)
OD 1 : 120 (mm)
OD 2 : 120 (mm)
ID 1 : 79 (mm)

CONT : 6
VOL : 0.064

Note : special product

H-85760 Hydraulic Oil Filter Metal End Cap Element

SUMITOMO KTJ11630



H 1 : 452 (mm)
H 2 : 449 (mm)
OD 1 : 136 (mm)
OD 2 : 136 (mm)
ID 1 : 110 (mm)
ID 2 : 110 (mm)

CONT : 4
VOL : 0.051

H-85820 Hydraulic Oil Filter Metal End Cap Element

BELAZ 6311-1-19
SPECIAL ORDER 6311-1-19



H 1 : 200 (mm)
OD 1 : 95 (mm)
OD 2 : 95 (mm)
ID 1 : 43 (mm)
ID 2 : 43 (mm)

CONT : 16
VOL : 0.041

Note : for Bellaz Dump Truck

H-85710 Hydraulic Oil Filter Metal End Cap Element

XGMA 60C0025



H 1 : 225 (mm)
OD 1 : 108 (mm)
OD 2 : 108 (mm)
ID 1 : 62 (mm)
Thread Size : M64X2

CONT : 1
VOL : 0.010

H-85770 Hydraulic Oil Filter Metal End Cap Element with synthetic media

SUNWARD 73040300186



H 1 : 548 (mm)
H 2 : 544 (mm)
OD 1 : 150 (mm)
OD 2 : 150 (mm)
ID 1 : 88 (mm)

CONT : 1
VOL : 0.016

H-85830 Hydraulic Oil Filter Metal End Cap Element

BELAZ 631BN-1-30N



H 1 : 405.5 (mm)
OD 1 : 247 (mm)
OD 2 : 247 (mm)
ID 1 : 161 (mm)
ID 2 : 161 (mm)

CONT : 4
VOL : 0.126

Note : Application Belaz Dump Trucks



Technical Specification

H-85840 Hydraulic Oil Filter Aluminium Casting Element
BESTON BH4TUF1209CH



H 1 : 114 (mm)
H 2 : 109 (mm)
OD 1 : 46 (mm)
OD 2 : 46 (mm)
ID 1 : 23 (mm)

CONT : 50
VOL : 0.018

H-85890 Hydraulic Oil Filter Metal End Cap Element
TEREX 15025076



H 1 : 395 (mm)
OD 1 : 110 (mm)
OD 2 : 110 (mm)
ID 1 : 61 (mm)
ID 2 : 61 (mm)

CONT : 9
VOL : 0.063

Note : for Loader XCMG 2L50

H-85940 Hydraulic Oil Filter Wire Mesh supported Element With Glass Fiber Media



H 1 : 169 (mm)
H 2 : 164 (mm)
OD 1 : 56 (mm)
OD 2 : 56 (mm)
ID 1 : 24.5 (mm)

CONT : 25
VOL : 0.018

H-85850 Hydraulic Oil Filter Aluminium Casting Element
BESTON BV1-96546B



H 1 : 117 (mm)
OD 1 : 80 (mm)
OD 2 : 80 (mm)
ID 1 : 44 (mm)

CONT : 50
VOL : 0.050

H-85900 Hydraulic Oil Filter Metal End Cap Element
WIRTGEN 156576



H 1 : 209 (mm)
H 2 : 204 (mm)
OD 1 : 56.3 (mm)
OD 2 : 56.3 (mm)
ID 1 : 24.5 (mm)

CONT : 25
VOL : 0.023

Note : for application W1000F, W1200F, W1300F

H-88010 Hydraulic Oil Filter Element
YAMASHIN RD 411-6212-0



H 1 : 200 (mm)
OD 1 : 106.7 (mm)
OD 2 : 106.7 (mm)
Thread Size : PT1

CONT : 12
VOL : 0.040

H-85860 Hydraulic Oil Filter Metal End Cap Element
MP FILTRI MF-100-1-A-P25-NB



H 1 : 90 (mm)
H 2 : 84.5 (mm)
OD 1 : 70 (mm)
OD 2 : 70 (mm)
ID 1 : 29 (mm)
ID 2 : 13.5 (mm)

CONT : 50
VOL : 0.034

H-85910 Hydraulic Oil Filter Metal End Cap Element



H 1 : 190 (mm)
OD 1 : 106 (mm)
OD 2 : 106 (mm)
ID 1 : 72 (mm)
ID 2 : 10 (mm)

CONT : 9
VOL : 0.032

H-88020 Hydraulic Oil Filter Element
KUBOTA 34150-37710



H 1 : 178.5 (mm)
H 2 : 170.5 (mm)
OD 1 : 23.75 (mm)
OD 2 : 23.75 (mm)
ID 1 : 16.2 (mm)

CONT : 50
VOL : 0.035

H-85870 Hydraulic Oil Filter Metal End Cap Element
SANY 12SY0126J8798



H 1 : 427.5 (mm)
H 2 : 422.5 (mm)
OD 1 : 150 (mm)
OD 2 : 150 (mm)
ID 1 : 98 (mm)
ID 2 : 98 (mm)

CONT : 4
VOL : 0.057

H-85920 Hydraulic Oil Filter Metal End Cap Element
FAUN HY504601



H 1 : 209.5 (mm)
H 2 : 204 (mm)
OD 1 : 51 (mm)
OD 2 : 51 (mm)
ID 1 : 23.5 (mm)

CONT : 25
VOL : 0.023

Note : for application Variopress, Powerpress

H-88030 Hydraulic Oil Filter Element Synthetic Media
KUBOTA RD431-62120



H 1 : 230 (mm)
OD 1 : 104.4 (mm)
OD 2 : 106.7 (mm)
Thread Size : PT1

CONT : 12
VOL : 0.046

H-85880 Hydraulic Oil Filter Metal End Cap Element
LINDE 000 983 1644



H 1 : 206 (mm)
H 2 : 201 (mm)
OD 1 : 56 (mm)
OD 2 : 56 (mm)
ID 1 : 24.5 (mm)

CONT : 25
VOL : 0.023

H-85930 Hydraulic Oil Filter Metal End Cap Element
ZOOMLINE 1010600488



H 1 : 123.5 (mm)
H 2 : 118 (mm)
OD 1 : 51 (mm)
OD 2 : 50.5 (mm)
ID 1 : 20 (mm)

CONT : 40
VOL : 0.018

H-88040 Hydraulic Oil Filter Element
KUBOTA RB411-62190

















H 1 : 178.5 (mm)
H 2 : 148.5 (mm)
OD 1 : 90 (mm)
OD 2 : 90 (mm)
ID 1 : 25.7 (mm)
Thread Size : 1 1/4X13 BSPT

CONT : 36
VOL : 0.067

















Technical Specification

<p>H-88050 Hydraulic Oil Filter Wire Mesh supported Element KUBOTA RD411-62210</p>  <p>H 1 : 177 (mm) H 2 : 159 (mm) OD 1 : 115 (mm) OD 2 : 110 (mm) Thread Size : 1 1/2"X11 BSPT</p> <p>CONT : 25 VOL : 0.077</p>	<p>H-88100 Hydraulic Oil Filter Suction Aluminium Casting Element KUBOTA 69284-62210</p>  <p>H 1 : 198 (mm) H 2 : 180 (mm) OD 1 : 115 (mm) OD 2 : 110 (mm) Thread Size : 1 1/2X11 TP</p> <p>CONT : 25 VOL : 0.087</p>	<p>H-89060 Hydraulic Oil Filter Aluminium Casting Element DOOSAN 400504-00240</p>  <p>H 1 : 134 (mm) H 2 : 127 (mm) OD 1 : 44 (mm) OD 2 : 42.5 (mm) ID 1 : 22.5 (mm)</p> <p>CONT : 50 VOL : 0.017</p>
<p>H-88060 Hydraulic Oil Filter Aluminium Casting Element Synthetic Media KUBOTA RD451-62120</p>  <p>H 1 : 277 (mm) H 2 : 243 (mm) OD 1 : 108 (mm) OD 2 : 108 (mm) Thread Size : 1X11 BSPT</p> <p>CONT : 6 VOL : 0.027</p>	<p>H-88110 Hydraulic Oil Filter Plastic Element BOBCAT 6692337</p>  <p>H 1 : 124.5 (mm) OD 1 : 72 (mm) OD 2 : 62.5 (mm) ID 1 : 24 (mm)</p> <p>CONT : 50 VOL : 0.047</p>	<p>H-89070 Hydraulic Oil Filter Pilot Aluminium Casting Element DOOSAN 400504-00241</p>  <p>H 1 : 85 (mm) H 2 : 77.5 (mm) OD 1 : 44 (mm) OD 2 : 42.5 (mm) ID 1 : 22.5 (mm)</p> <p>CONT : 50 VOL : 0.014</p>
<p>H-88070 Hydraulic Oil Filter Aluminium Casting Element KUBOTA 68773-62210</p>  <p>H 1 : 177 (mm) H 2 : 159 (mm) OD 1 : 100 (mm) OD 2 : 95 (mm) Thread Size : 1 1/4 BSPT</p> <p>CONT : 16 VOL : 0.038</p> <p>Note : Kubota KH151?, KH191?, U35, U35SS, KX61-2, KX61-2S, KX91-3, KX91-3S, R420S, R520</p>	<p>H-8902 Hydraulic Oil Filter Element DAEWOO D 501564 KUBOTA RA011-62190</p>  <p>H 1 : 168 (mm) H 2 : 125 (mm) OD 1 : 90 (mm) OD 2 : 89 (mm) Thread Size : 3/4X14 BSPT</p> <p>CONT : 25 VOL : 0.053</p>	<p>H-89080 Hydraulic Oil Filter Metal End Cap Element DOOSAN OM631-1</p>  <p>H 1 : 200 (mm) OD 1 : 95 (mm) OD 2 : 95 (mm) ID 1 : 43 (mm) ID 2 : 43 (mm)</p> <p>CONT : 12 VOL : 0.028</p>
<p>H-88080 Hydraulic Oil Filter Return Aluminium Casting Element Synthetic Media KUBOTA RD431-62122</p>  <p>H 1 : 226 (mm) OD 1 : 108 (mm) OD 2 : 108 (mm) Thread Size : 1"X11 BSPT</p> <p>CONT : 12 VOL : 0.040</p>	<p>H-89030 Hydraulic Oil Filter Metal End Cap Element DAEWOO 2474-9016A DOOSAN 2474-9016A</p>  <p>H 1 : 146 (mm) H 2 : 140 (mm) OD 1 : 150 (mm) OD 2 : 150 (mm) ID 1 : 73.4 (mm) Thread Size : M12X1.75</p> <p>CONT : 9 VOL : 0.045</p>	<p>HC-1014 Hydraulic Oil Filter Spin-On KATO 689-3570302-1 KATO 689-3570303-2</p>  <p>H 1 : 132 (mm) OD 1 : 94 (mm) Thread Size : M22X1.5-6H</p> <p>CONT : 12 VOL : 0.021</p>
<p>H-88090 Hydraulic Oil Filter Return Aluminium Casting Element Synthetic Media KUBOTA RC461-62150</p>  <p>H 1 : 198 (mm) H 2 : 181.5 (mm) OD 1 : 90 (mm) OD 2 : 90 (mm) Thread Size : 1X11 BSPT</p> <p>CONT : 25 VOL : 0.053</p>	<p>H-89050 Hydraulic Oil Filter Pilot Metal End Cap Element DAEWOO 474-00009</p>  <p>H 1 : 136.5 (mm) H 2 : 133 (mm) OD 1 : 42.5 (mm) OD 2 : 42.5 (mm) ID 1 : 21.5 (mm)</p> <p>CONT : 50 VOL : 0.018</p>	<p>HC-1119 Hydraulic Oil Filter Transmission Spin-On TOYOTA 32670-12620-71</p>  <p>H 1 : 80 (mm) OD 1 : 74 (mm) Thread Size : 3/4-16 UNF-2B BPV (kg/cm²) : 0.8 - 1.2 ADB V : YES Gasket Type : Round</p> <p>CONT : 50 VOL : 0.030</p>

















Technical Specification

<p>HC-18050 Hydraulic Oil Filter Spin-On KUBOTA HHK20-36990</p>  <p>H 1 : 100 (mm) OD 1 : 80 (mm) Thread Size : 3/4-16 UNF-2B ADBV : YES Gasket Type : Round</p> <p>CONT : 50 VOL : 0.045</p> <p>Note : Can be used for the transmission filter</p>	<p>HC-1902 Hydraulic Oil Filter Transmission Spin-On NEW HOLLAND (CNH) 83912256</p>  <p>H 1 : 164 (mm) OD 1 : 93 (mm) Thread Size : 1 1/8-16 UNF-2B Gasket Type : Square</p> <p>CONT : 12 VOL : 0.025</p>	<p>HC-2701 Hydraulic Oil Filter Transmission Spin-On HITACHI 4230376 HITACHI 4286837 KOMATSU BW252116</p>  <p>H 1 : 213.5 (mm) OD 1 : 93 (mm) Thread Size : 1"X12 Thread Nut Size : M24X1.5 ADBV : YES Gasket Type : Square</p> <p>CONT : 12 VOL : 0.030</p>
<p>HC-18051 Hydraulic Oil Filter Suction Spin-On KUBOTA HHK71-14080 KUBOTA K7561-1408</p>  <p>H 1 : 100 (mm) OD 1 : 80 (mm) Thread Size : 3/4-16 UNF-2B ADBV : YES Gasket Type : Round</p> <p>CONT : 50 VOL : 0.045</p>	<p>HC-1903 Hydraulic Oil Filter Spin-On MASSEY-FERGUSON 1033356M1 FIAT 70248399</p>  <p>H 1 : 136 (mm) OD 1 : 93 (mm) Thread Size : 1"X12 Gasket Type : Square</p> <p>CONT : 12 VOL : 0.021</p>	<p>HC-2703 Hydraulic Oil Filter Spin-On TCM 26267-67002</p>  <p>H 1 : 199 (mm) OD 1 : 108 (mm) Thread Size : 1 1/4"X12 Gasket Type : Square</p> <p>CONT : 6 VOL : 0.020</p> <p>Note : wire mesh media</p>
<p>HC-18150 Hydraulic Oil Filter Spin-On ISEKI 1608-206-260-0</p>  <p>H 1 : 70 (mm) OD 1 : 80 (mm) Thread Size : M20X1.5-6H BPV (kg/cm2) : 2.0 - 2.5 ADBV : YES Gasket Type : Round</p> <p>CONT : 36 VOL : 0.026</p>	<p>HC-19040 Hydraulic Oil Filter Spin-On DITCH WITCH 155910 BOBCAT 6660728</p>  <p>H 1 : 136 (mm) OD 1 : 93 (mm) Thread Size : 1"X12 Gasket Type : Square</p> <p>CONT : 12 VOL : 0.022</p>	<p>HC-2704 Hydraulic Oil Filter Spin-On With Glass Fiber Media HITACHI 17C69847</p>  <p>H 1 : 100 (mm) OD 1 : 93 (mm) Thread Size : 1"X12 ADBV : YES Gasket Type : Round</p> <p>CONT : 12 VOL : 0.017</p>
<p>HC-1822 Hydraulic Oil Filter Element DEUTZ 1173481 NISSAN 58396-47601</p>  <p>H 1 : 135 (mm) OD 1 : 93 (mm) Thread Size : 1"X12 BPV (kg/cm2) : 1.4 - 1.6 ADBV : YES Gasket Type : Round</p> <p>CONT : 25 VOL : 0.042</p>	<p>HC-1905 Hydraulic Oil Filter Spin-On NEW HOLLAND (CNH) 82005016 FORD FONN B486 BB</p>  <p>H 1 : 243 (mm) OD 1 : 136 (mm) Thread Size : 1 3/4"X16 Gasket Type : Square</p> <p>CONT : 6 VOL : 0.039</p>	<p>HC-2705 Hydraulic Oil Filter Spin-On Synthetic Media HITACHI 17C77012</p>  <p>H 1 : 233 (mm) OD 1 : 93 (mm) Thread Size : 1 1/8-16 UNF-2B ADBV : YES</p> <p>CONT : 12 VOL : 0.034</p>
<p>HC-1901 Hydraulic Oil Filter Transmission Spin-On FORDFINISCODE 3912256 FORD D6NN-B486 CA FORD D8NN-B486 CA</p>  <p>H 1 : 170 (mm) OD 1 : 93 (mm) Thread Size : 1 1/8-16 UNF-2B BPV (kg/cm2) : 0.8 - 1.2 Gasket Type : Square</p> <p>CONT : 25 VOL : 0.052</p>	<p>HC-19060 Hydraulic Oil Filter Spin-On CROSS 1A9253</p>  <p>H 1 : 227 (mm) OD 1 : 129 (mm) Thread Size : 1 1/2"X16 Gasket Type : Square</p> <p>CONT : 6 VOL : 0.023</p> <p>Note : For engine :F23 Series, GBF23 Series</p>	<p>HC-2709 Hydraulic Oil Filter Spin-On Cellulose media HITACHI 4630525</p>  <p>H 1 : 168 (mm) OD 1 : 82.5 (mm) Thread Size : M68X2</p> <p>CONT : 12 VOL : 0.021</p>



Technical Specification

<p>HC-28130 Hydraulic Oil Filter Spin-On</p> <p>HYUNDAI 31N8-01360</p>  <p>H 1 : 130 (mm) OD 1 : 93 (mm) Thread Size : 1 1/8-16 UNF-2B Gasket Type : Round</p> <p>CONT : 50 VOL : 0.073</p>	<p>HC-45050 Hydraulic Oil Filter Spin-On Synthetic Media</p> <p>CASE-IH CNH 1302541 CASE-IH CNH 181167A1 CUMMINS 181167A1</p>  <p>H 1 : 152 (mm) OD 1 : 94.5 (mm) Thread Size : 13/16"X16 Gasket Type : Round</p> <p>CONT : 12 VOL : 0.024</p> <p>Note : Aluminium casting version</p>	<p>HC-45100 Hydraulic Oil Filter Transmission Spin-On</p> <p>NEW HOLLAND (CNH) MT40007563</p>  <p>H 1 : 135 (mm) OD 1 : 93.5 (mm) Thread Size : 1"X12</p> <p>CONT : 20 VOL : 0.036</p> <p>Note : New Holland Tractor 936</p>
<p>HC-42090 Hydraulic Oil Filter Spin-On With Glass Fiber Media</p> <p>FIAT 73133001 CATERPILLAR 9U6985</p>  <p>H 1 : 270 (mm) OD 1 : 123 (mm) Thread Size : 1 1/2"X16</p> <p>CONT : 6 VOL : 0.033</p>	<p>HC-45060 Hydraulic Oil Filter Spin-On</p> <p>NEW HOLLAND (CNH) 47671640 SHIBAURA SBA340501030</p>  <p>H 1 : 100 (mm) OD 1 : 80 (mm) Thread Size : 3/4-16 UNF-2B ADBV : YES Gasket Type : Square</p> <p>CONT : 12 VOL : 0.010</p> <p>Note : models:T1510,T1520,T1530</p>	<p>HC-45110 Hydraulic Oil Filter Spin-On</p> <p>NEW HOLLAND (CNH) 1909130 CASE 1931127</p>  <p>H 1 : 179 (mm) OD 1 : 108 (mm) Thread Size : 1 1/8-16 UNF-2B</p> <p>CONT : 12 VOL : 0.036</p>
<p>HC-45020 Hydraulic Oil Filter Spin-On</p> <p>NEW HOLLAND (CNH) 47131197</p>  <p>H 1 : 140 (mm) OD 1 : 136 (mm) Thread Size : 1 3/4"X16 Gasket Type : Square</p> <p>CONT : 6 VOL : 0.021</p>	<p>HC-45070 Hydraulic Oil Filter Spin-On</p> <p>NEW HOLLAND (CNH) 5174044</p>  <p>H 1 : 165 (mm) OD 1 : 136 (mm) Thread Size : 1 3/4"X16 Gasket Type : Square</p> <p>CONT : 6 VOL : 0.028</p>	<p>HC-45140 Hydraulic Oil Filter Spin-On</p> <p>CASE 84581942 NEW HOLLAND (CNH) 84581942</p>  <p>H 1 : 243 (mm) OD 1 : 136 (mm) Thread Size : M55X1.5</p> <p>CONT : 6 VOL : 0.037</p>
<p>HC-45030 Hydraulic Oil Filter aluminium casting Spin-On Synthetic Media</p> <p>DANA-SPICER 4209440 CASE-IH CNH 76086226</p>  <p>H 1 : 181 (mm) OD 1 : 94.5 (mm) Thread Size : 2"X16</p> <p>CONT : 12 VOL : 0.028</p>	<p>HC-45080 Hydraulic Oil Filter Spin-On</p> <p>SHIBAURA SBA340500960</p>  <p>H 1 : 201.7 (mm) OD 1 : 108 (mm) Thread Size : 1 1/8-16 UNF-2B BPV (kg/cm²) : 0.8 - 1.2 Gasket Type : Round</p> <p>CONT : 6 VOL : 0.020</p> <p>Note : Used in models:T2410, TC48DA, TC55DA, T2420</p>	<p>HC-45150 Hydraulic Oil Filter Transmission Spin-On</p> <p>STEYR-DAIMLER-PUCH 37700750066 STEYR-DAIMLER-PUCH 397750036</p>  <p>H 1 : 172 (mm) OD 1 : 93 (mm) Thread Size : M33X1.5</p> <p>CONT : 12 VOL : 0.023</p>
<p>HC-45040 Hydraulic Oil Filter Spin-On</p> <p>NEW HOLLAND (CNH) 47427174 NEW HOLLAND (CNH) 82983474</p>  <p>H 1 : 260 (mm) OD 1 : 118 (mm) Thread Size : 1 3/4"X16 Gasket Type : Square</p> <p>CONT : 6 VOL : 0.031</p>	<p>HC-45090 Hydraulic Oil Filter Spin-On</p> <p>SHIBAURA SBA340500951</p>  <p>H 1 : 210 (mm) OD 1 : 125 (mm) Thread Size : 1 1/2"X16</p> <p>CONT : 6 VOL : 0.029</p> <p>Note : Used in models:T2410, TC55DA, T2420</p>	<p>HC-45160 Hydraulic Oil Filter Transmission Spin-On</p> <p>STEYR-DAIMLER-PUCH 337.00.73.0095 STEYR-DAIMLER-PUCH 33700730095</p>  <p>H 1 : 108 (mm) OD 1 : 93 (mm) Thread Size : M33X1.5</p> <p>CONT : 36 VOL : 0.044</p>



Technical Specification

HC-47010 Hydraulic Oil Filter Spin-On

ISEKI 1742-508-332-00



H 1 : 200 (mm)
OD 1 : 108 (mm)
Thread Size : 1 1/4"X12
Gasket Type : Square

CONT : 12
VOL : 0.039

HC-51040 Hydraulic Oil Filter Spin-On

SAME_HURLIMANN,LAMBORGHINI
244192800



H 1 : 181 (mm)
OD 1 : 108 (mm)
Thread Size : M40X2.0
Gasket Type : Square

CONT : 12
VOL : 0.036

HC-52030 Hydraulic Oil Filter Spin-On

YANMAR 1A811548310



H 1 : 145 (mm)
OD 1 : 94 (mm)
Thread Size : 1 1/2"X16 UN-2B

CONT : 12
VOL : 0.020

HC-47020 Hydraulic Oil Filter Spin-On

ISEKI 3667-354-2400-0
BEAL 3667-354-2400-0/A



H 1 : 75 (mm)
OD 1 : 80 (mm)
Thread Size : M20X1.5-6H

CONT : 40
VOL : 0.028

HC-51060 Hydraulic Oil Filter Transmission Spin-On

MASSEY-FERGUSON 3386701M1
MASSEY-FERGUSON 3386701M2
MASSEY-FERGUSON 3386701M3



H 1 : 251 (mm)
OD 1 : 136 (mm)
Thread Size : M42X2
Gasket Type : Square

CONT : 6
VOL : 0.028

HC-5401 Hydraulic Oil Filter Spin-On

YAMASHIN CSP-10L-30



H 1 : 290 (mm)
OD 1 : 125 (mm)
Thread Size : M48X2

CONT : 6
VOL : 0.041

HC-5101 Hydraulic Oil Filter Spin-On

MASSEY-FERGUSON 3595175M1



H 1 : 143 (mm)
OD 1 : 93 (mm)
Thread Size : M24X2
Gasket Type : Square

CONT : 12
VOL : 0.022

HC-51070 Hydraulic Oil Filter Spin-On

MASSEY-FERGUSON 3383386-M92
AGCO 3383386M92



H 1 : 235 (mm)
OD 1 : 136 (mm)
Thread Size : M42X2.0
Gasket Type : Square

CONT : 6
VOL : 0.034

HC-5402 Hydraulic Oil Filter Spin-On

INTERNATIONAL HARVESTER
1103452C2
INTERNATIONAL HARVESTER
1103462-C1



H 1 : 225 (mm)
OD 1 : 127 (mm)
Thread Size : 3"X8

CONT : 6
VOL : 0.031

HC-51020 Hydraulic Oil Filter Transmission Spin-On With Glass Fiber Media

CATERPILLAR 1238189
HYSTER 1655472
CLARK 4202525
MANITOU 550145
GROVE-MANLIFT 7437000873



H 1 : 152 (mm)
OD 1 : 94.5 (mm)
Thread Size : 2"X16

CONT : 12
VOL : 0.024

HC-52010 Hydraulic Oil Filter Transmission Spin-On

YANMAR 172638-73730
KUBOTA 68051-62220
YAMASHIN C-SP04-10



H 1 : 100 (mm)
OD 1 : 80 (mm)
Thread Size : 3/4-16 UNF-2B
ADBV : YES
Gasket Type : Round

CONT : 50
VOL : 0.046

HC-54040 Hydraulic Oil Filter Spin-On Synthetic Media

IHI 075914201
KUBOTA RD809-62240
KUBOTA RD809-62241



H 1 : 310 (mm)
H 2 : 293 (mm)
OD 1 : 134.5 (mm)
Thread Size : M100X2.0

CONT : 6
VOL : 0.046

HC-51030 Hydraulic Oil Filter Spin-On

MANITOU 745878



H 1 : 152 (mm)
OD 1 : 94.5 (mm)
Thread Size : 1 3/8"X12

CONT : 12
VOL : 0.024

HC-52020 Hydraulic Oil Filter Transmission Spin-On

KUBOTA W21TSH6600



H 1 : 100 (mm)
OD 1 : 80 (mm)
Thread Size : 3/4-16 UNF-2B
ADBV : YES
Gasket Type : Round

CONT : 50
VOL : 0.054

HC-54050 Hydraulic Oil Filter Spin-On

IHI 075914401



H 1 : 201.7 (mm)
OD 1 : 108 (mm)
Thread Size : 1 1/8-16 UNF-2B
Gasket Type : Round

CONT : 6
VOL : 0.020



Technical Specification

HC-5501 Hydraulic Oil Filter Spin-On

CATERPILLAR 4T-7948
DAEWOO D140182
DAEWOO D140182S



H 1 : 111 (mm)
OD 1 : 93 (mm)
Thread Size : 13/16"X16
Gasket Type : Square

CONT : 12
VOL : 0.018

HC-5506 Hydraulic Oil Filter Spin-On Synthetic Media

CATERPILLAR 310694
CASE A49386
JOHN DEERE AT112393



H 1 : 293 (mm)
OD 1 : 116 (mm)
Thread Size : 1 3/4"X12

CONT : 6
VOL : 0.035

Note : with glass fiber media

HC-5512 Hydraulic Oil Filter Spin-On Synthetic Media

CATERPILLAR 126-1817



H 1 : 293 (mm)
OD 1 : 116 (mm)
Thread Size : 1 3/4"X12

CONT : 6
VOL : 0.035

Note : Aluminium Casting

HC-5502 Hydraulic Oil Filter Spin-On

DEMAG 04425274
DEMAG 4425274
JOHN DEERE AZ36942



H 1 : 305 (mm)
OD 1 : 136 (mm)
Thread Size : 1 1/2"X16
ADBV : YES
Gasket Type : Square

CONT : 6
VOL : 0.046

HC-5507 Hydraulic Oil Filter Spin-On Synthetic Media

CATERPILLAR 144-6691
DEUTZ 4118911
CLARK 6661248
NEW HOLLAND (CNH) 920019190



H 1 : 152 (mm)
OD 1 : 94.5 (mm)
Thread Size : 1 3/8"X12

CONT : 12
VOL : 0.024

HC-5516 Hydraulic Oil Filter aluminium casting Spin-On Synthetic Media

CLARK 062827440
CATERPILLAR 1850337
CLARK 62827440
NEW HOLLAND (CNH) 86597482



H 1 : 240 (mm)
OD 1 : 76.5 (mm)
Thread Size : 2"X12

CONT : 12
VOL : 0.026

HC-5503 Hydraulic Oil Filter Spin-On Synthetic Media

CATERPILLAR 1081153
INGERSOLL RAND 51302214
VOLVO BM 9658998



H 1 : 293 (mm)
OD 1 : 122 (mm)
Thread Size : 1 3/4"X12

CONT : 6
VOL : 0.034

Note : with Glass Fiber media

HC-5508 Hydraulic Oil Filter Spin-On Synthetic Media

KOMATSU 1281327H1
CASE 1346028C1
CATERPILLAR 9T5916



H 1 : 240 (mm)
OD 1 : 94.5 (mm)
Thread Size : 1 3/8"X12

CONT : 12
VOL : 0.036

Note : with Glass Fiber Media

HC-55170 Hydraulic Oil Filter Spin-On Synthetic Media

CATERPILLAR 1261813
CHARLES MACHINE 149939
CHARLES MACHINE 149939A
CATERPILLAR 3I1767
VERMEER 609135003



H 1 : 138 (mm)
OD 1 : 76 (mm)
Thread Size : 2"X12

CONT : 12
VOL : 0.016

Note : efficiency 10 micron absolute

HC-5504 Hydraulic Oil Filter Spin-On Synthetic Media

CASE 132575302
CATERPILLAR 1G-8878
NEW HOLLAND (CNH) 81863799



H 1 : 240 (mm)
OD 1 : 94.5 (mm)
Thread Size : 1 3/8"X12
Gasket Type : Square

CONT : 12
VOL : 0.036

Note : HC-7927 ==> cellulose media
HC-5504 ==> with glass fiber media

HC-55090 Hydraulic Oil Filter aluminium casting Spin-On Synthetic Media

JOHN DEERE T175002



H 1 : 240 (mm)
OD 1 : 94 (mm)
Thread Size : 1 3/8"X12

CONT : 12
VOL : 0.040

HC-55180 Hydraulic Oil Filter aluminium casting Spin-On Synthetic Media

LULL 10867527
VERMEER 1096010031
CATERPILLAR 184-3931
CATERPILLAR 3I-1769
CATERPILLAR 4I-3948



H 1 : 138 (mm)
OD 1 : 76 (mm)
Thread Size : 2"X12

CONT : 12
VOL : 0.016

Note : efficiency 20 micron absolute

HC-5505 Hydraulic Oil Filter Spin-On Cellulose media

CATERPILLAR 184-3931
CATERPILLAR 4I3948



H 1 : 138 (mm)
OD 1 : 76 (mm)
Thread Size : 2"X12

CONT : 12
VOL : 0.019

Note : Glass Fiber media uses HC-55180

HC-5511 Hydraulic Oil Filter Spin-On

INTERNATIONAL HARVESTER 1976934C3
CATERPILLAR 4T-6788
CATERPILLAR 8J-1600



H 1 : 173 (mm)
OD 1 : 123 (mm)
Thread Size : 1 1/2"X16-2B
Gasket Type : Square

CONT : 6
VOL : 0.025

HC-55190 Hydraulic Oil Filter Spin-On With Glass Fiber Media

VOLVO 11037650
VOLVO 110376506
CHARLES MACHINE 149641A
J.C.BAMFORD 32/922500

















H 1 : 240 (mm)
OD 1 : 94.5 (mm)
Thread Size : 1 3/8"X12

CONT : 12
VOL : 0.035

















Technical Specification

<p>HC-55200 Hydraulic Oil Filter Spin-On</p> <p>CATERPILLAR 4I-3950</p>  <p>H 1 : 240 (mm) OD 1 : 76.5 (mm) Thread Size : 2"X12</p> <p>CONT : 12 VOL : 0.027</p>	<p>HC-55260 Hydraulic Oil Filter Spin-On Synthetic Media</p> <p>CATERPILLAR 3I0700 INGERSOLL RAND 59945402 PALL HC7500SDK4H PALL HC7500SDK4HSYN</p>  <p>H 1 : 173 (mm) OD 1 : 123 (mm) Thread Size : 1 1/2"X16 Gasket Type : Square</p> <p>CONT : 6 VOL : 0.025</p>	<p>HC-55310 Hydraulic Oil Filter Spin-On With Glass Fiber Media</p> <p>CATERPILLAR 9T-6636</p>  <p>H 1 : 193 (mm) OD 1 : 116 (mm) Thread Size : 1 3/4"X12 Gasket Type : Round</p> <p>CONT : 6 VOL : 0.024</p>
<p>HC-55220 Hydraulic Oil Filter Spin-On With Glass Fiber Media</p> <p>CATERPILLAR 1261815 CHARLES MACHINE 159074</p>  <p>H 1 : 152 (mm) OD 1 : 94.5 (mm) Thread Size : 1 3/8"X12</p> <p>CONT : 12 VOL : 0.024</p>	<p>HC-55270 Hydraulic Oil Filter Spin-On Synthetic Media</p> <p>CATERPILLAR 3I1878</p>  <p>H 1 : 293 (mm) OD 1 : 116 (mm) Thread Size : 1 3/4"X12</p> <p>CONT : 6 VOL : 0.034</p>	<p>HC-5601 Hydraulic Oil Filter Spin-On</p> <p>KOMATSU 113-60-23160</p>  <p>H 1 : 221 (mm) OD 1 : 108 (mm) Thread Size : 1 1/8-16 UNF-2B Gasket Type : Square</p> <p>CONT : 6 VOL : 0.022</p>
<p>HC-55230 Hydraulic Oil Filter Spin-On</p> <p>CATERPILLAR 3I-0606</p>  <p>H 1 : 144.5 (mm) OD 1 : 93 (mm) Thread Size : 1 1/4"X12 Gasket Type : Square</p> <p>CONT : 12 VOL : 0.022</p>	<p>HC-55280 Hydraulic Oil Filter aluminium casting Spin-On Synthetic Media</p> <p>CATERPILLAR 2254118</p>  <p>H 1 : 293 (mm) OD 1 : 116 (mm) Thread Size : 1 3/4"X12</p> <p>CONT : 6 VOL : 0.033</p>	<p>HC-5602 Hydraulic Oil Filter Spin-On</p> <p>KOMATSU 113-60-43320 KOMATSU 113-60-43321 KOMATSU 209-607-6210 HITACHI 4205684 KUBOTA 68773-62230</p>  <p>H 1 : 171 (mm) OD 1 : 125 (mm) Thread Size : M48X2</p> <p>CONT : 6 VOL : 0.023</p>
<p>HC-55240 Hydraulic Oil Filter aluminium casting Spin-On Synthetic Media</p> <p>CATERPILLAR 3I0568 INGERSOLL RAND 90536046 FORD 9576P163555</p>  <p>H 1 : 240 (mm) OD 1 : 94.5 (mm) Thread Size : 1 3/8"X12</p> <p>CONT : 12 VOL : 0.036</p>	<p>HC-55290 Hydraulic Oil Filter Spin-On Synthetic Media</p> <p>CATERPILLAR 1440832 CATERPILLAR 2237809 CATERPILLAR 3I1914 INGERSOLL RAND 59888990 PALL HC7500SDN4H</p>  <p>H 1 : 173 (mm) OD 1 : 123 (mm) Thread Size : 1 1/2"X16 Gasket Type : Square</p> <p>CONT : 6 VOL : 0.023</p>	<p>HC-5603 Hydraulic Oil Filter Return Spin-On</p> <p>KOMATSU 21N-60-12210 YAMASHIN CSP-10L-10</p>  <p>H 1 : 289 (mm) OD 1 : 127 (mm) Thread Size : M48X2</p> <p>CONT : 6 VOL : 0.041</p>
<p>HC-55250 Hydraulic Oil Filter aluminium casting Spin-On Synthetic Media</p> <p>VOLVO 0965899 CATERPILLAR 3I0696</p>  <p>H 1 : 293 (mm) OD 1 : 116 (mm) Thread Size : 1 3/4"X12</p> <p>CONT : 6 VOL : 0.036</p>	<p>HC-55300 Hydraulic Oil Filter Spin-On</p> <p>CATERPILLAR 126-1814 VOLVO 208151 VERMEER 609136003</p>  <p>H 1 : 240 (mm) OD 1 : 76.5 (mm) Thread Size : 2"X12</p> <p>CONT : 12 VOL : 0.026</p>	<p>HC-56060 Hydraulic Oil Filter Spin-On</p> <p>KOMATSU 418-18-34160 KOMATSU 418-183-4160</p>  <p>H 1 : 155 (mm) OD 1 : 82.5 (mm) ID 1 : 155 (mm) Thread Size : M45X1.5-6H Gasket Type : Round</p> <p>CONT : 12 VOL : 0.019</p> <p>Note : for Komatsu Wheel Loader WA200-5</p>



Technical Specification

<p>HC-56080 Hydraulic Oil Filter pump drain Spin-On</p> <p>KOMATSU 21T-60-31450</p>  <p>H 1 : 242.5 (mm) OD 1 : 125 (mm) Thread Size : M38X2</p> <p>CONT : 6 VOL : 0.032</p>	<p>HC-5801 Hydraulic Oil Filter Spin-On</p> <p>CATERPILLAR 093-7521 KUBOTA 172179-73720 CATERPILLAR 937520</p>  <p>H 1 : 172 (mm) OD 1 : 93 (mm) Thread Size : 1 1/8-16 UNF-2B Gasket Type : Round</p> <p>CONT : 12 VOL : 0.024</p>	<p>HC-5806 Hydraulic Oil Filter Spin-On</p> <p>MITSUBISHI LPF 08</p>  <p>H 1 : 168 (mm) OD 1 : 93 (mm) Thread Size : 1 1/8-16 UNF-2B Gasket Type : Round</p> <p>CONT : 25 VOL : 0.052</p>
<p>HC-57020 Hydraulic Oil Filter aluminium casting Spin-On Synthetic Media</p> <p>CASE-IH CNH 1272051X1 CATERPILLAR 310550 CATERPILLAR 310567 CASE-IH CNH 92451 CASE-IH CNH A165029</p>  <p>H 1 : 152 (mm) OD 1 : 95 (mm) Thread Size : 1 3/8"X12</p> <p>CONT : 12 VOL : 0.023</p>	<p>HC-58012 Hydraulic Oil Filter Full Flow Spin-On</p> <p>MITSUBISHI C 45702411</p>  <p>H 1 : 140 (mm) OD 1 : 93 (mm) Thread Size : 1 1/8-16 UNF-2B</p> <p>CONT : 20 VOL : 0.033</p> <p>Note : HC-5801 (height difference)</p>	<p>HC-5807 Hydraulic Oil Filter Spin-On</p> <p>MITSUBISHI 91004-10021 YSK IHI-075511900 MITSUBISHI LPF 010</p>  <p>H 1 : 141 (mm) OD 1 : 93 (mm) Thread Size : 1 1/8-16 UNF-2B Gasket Type : Round</p> <p>CONT : 25 VOL : 0.046</p>
<p>HC-57030 Hydraulic Oil Filter Spin-On With Glass Fiber Media</p> <p>INGERSOLL RAND 39136650 CATERPILLAR 310553 CATERPILLAR 311907 FORD 9576P163428</p>  <p>H 1 : 152 (mm) OD 1 : 95 (mm) Thread Size : 1 3/8"X12</p> <p>CONT : 12 VOL : 0.042</p>	<p>HC-5802 Hydraulic Oil Filter Spin-On</p> <p>HOKUETSU KOGYO 3743-803401 HOKUETSU KOGYO 37438-03400</p>  <p>H 1 : 220 (mm) OD 1 : 125 (mm) Thread Size : 1 1/2-12 UNF-2B Gasket Type : Square</p> <p>CONT : 6 VOL : 0.028</p>	<p>HC-58073 Hydraulic Oil Filter Spin-On</p> <p>KUBOTA 68131-6213-0</p>  <p>H 1 : 141 (mm) OD 1 : 93 (mm) Thread Size : 1 1/8-16 UNF-2B</p> <p>CONT : 12 VOL : 0.025</p> <p>Note : With grip body version HC-5807</p>
<p>HC-57040 Hydraulic Oil Filter Spin-On</p> <p>TIGERCAT AY052</p>  <p>H 1 : 270 (mm) OD 1 : 123 (mm) Thread Size : 1 1/2"X16</p> <p>CONT : 6 VOL : 0.033</p> <p>Note : with water separation media</p>	<p>HC-5803 Hydraulic Oil Filter Spin-On</p> <p>MITSUBISHI 375402-0000</p>  <p>H 1 : 171 (mm) OD 1 : 108 (mm) Thread Size : 1 1/8-16 UNF-2B Gasket Type : Square</p> <p>CONT : 12 VOL : 0.034</p>	<p>HC-58090 Hydraulic Oil Filter Spin-On</p> <p>KOMATSU 361-60-11121</p>  <p>H 1 : 155 (mm) OD 1 : 93 (mm) Thread Size : 1 1/8-16 UNF-2B Gasket Type : Square</p> <p>CONT : 12 VOL : 0.024</p>
<p>HC-57041 Hydraulic Oil Filter Spin-On</p> <p>MANITOU 949530</p>  <p>H 1 : 270 (mm) OD 1 : 123 (mm) Thread Size : 1 1/2"X16</p> <p>CONT : 6 VOL : 0.035</p>	<p>HC-5804 Hydraulic Oil Filter Spin-On</p> <p>MITSUBISHI 37438-03300 MITSUBISHI 37438-05601</p>  <p>H 1 : 220 (mm) OD 1 : 108 (mm) Thread Size : 1 1/8-16 UNF-2B Gasket Type : Square</p> <p>CONT : 6 VOL : 0.023</p>	<p>HC-5810 Hydraulic Oil Filter Spin-On</p> <p>MITSUBISHI 37438-02300 MITSUBISHI 375401-0000</p>  <p>H 1 : 120 (mm) OD 1 : 108 (mm) Thread Size : 1 1/8-16 UNF-2B Gasket Type : Square</p> <p>CONT : 12 VOL : 0.026</p>



Technical Specification

HC-5815 Hydraulic Oil Filter Spin-On
MITSUBISHI 34550-33102



H 1 : 174 (mm)
OD 1 : 94 (mm)
Thread Size : 1 1/8-16 UNF-2B
ADBV : YES
Gasket Type : Square

CONT : 12
VOL : 0.027

Note : with magnet version uses HC-5816

HC-60010 Hydraulic Oil Filter Pilot aluminium casting Spin-On Synthetic Media
NEW HOLLAND (CNH) 47635916
SUMITOMO KHJ10950



H 1 : 165 (mm)
OD 1 : 82.5 (mm)
Thread Size : M45X2.0-6H

CONT : 12
VOL : 0.021

HC-6502 Hydraulic Oil Filter Spin-On Synthetic Media
GENERAL MOTORS 25010643



H 1 : 260 (mm)
OD 1 : 118 (mm)
Thread Size : 1 5/16"X12
Gasket Type : Square

CONT : 6
VOL : 0.032

HC-5816 Hydraulic Oil Filter Spin-On
KUBOTA 33960-82630
KUBOTA 33960-82631
KUBOTA 33960-82632



H 1 : 174 (mm)
OD 1 : 94 (mm)
Thread Size : 1 1/8-16 UNF-2B
ADBV : YES
Gasket Type : Square

CONT : 12
VOL : 0.027

HC-62010 Hydraulic Oil Filter Spin-On
ALLIS CHALMERS 1329308
AG CHEM EQUIPMENT 708476
AG CHEM EQUIPMENT 709666



H 1 : 173 (mm)
OD 1 : 123 (mm)
Thread Size : 1 1/2"X16
Gasket Type : Square

CONT : 6
VOL : 0.025

HC-6801 Hydraulic Oil Filter Spin-On
DEMAG 057 732 74
CASE 402219303
COMP AIR 516 131 0



H 1 : 174.4 (mm)
OD 1 : 93 (mm)
Thread Size : 1"X12
Gasket Type : Square

CONT : 12
VOL : 0.026

HC-5817 Hydraulic Oil Filter Spin-On
KUBOTA T0070-37711



H 1 : 174 (mm)
OD 1 : 94 (mm)
Thread Size : 1 1/8-16 UNF-2B
Gasket Type : Square

CONT : 12
VOL : 0.026

HC-62020 Hydraulic Oil Filter Spin-On
MASSEY-FERGUSON 2754362M1
LIEBHERR 5612546
BOMAG 5821213



H 1 : 174.4 (mm)
OD 1 : 93 (mm)
Thread Size : 1"X12
Gasket Type : Square

CONT : 12
VOL : 0.026

HC-6802 Hydraulic Oil Filter Spin-On
MASSEY-FERGUSON 2979653M1
VOLVO 4787923
INGERSOLL RAND 54672654



H 1 : 213.5 (mm)
OD 1 : 93 (mm)
Thread Size : 1"X12
ADBV : YES
Gasket Type : Square

CONT : 12
VOL : 0.031

HC-5902 Hydraulic Oil Filter Spin-On
TOYOTA 67501-41830-71



H 1 : 139 (mm)
OD 1 : 93 (mm)
Thread Size : 3/4-16 UNF-2B

CONT : 12
VOL : 0.021

HC-6217 Hydraulic Oil Filter Spin-On
ATLAS COPCO 1613610500
ATLAS COPCO 1619-3771



H 1 : 206 (mm)
OD 1 : 93 (mm)
Thread Size : 1"X12
BPV (kg/cm2) : 2.0 - 2.5
Gasket Type : Square

CONT : 12
VOL : 0.028

HC-6803 Hydraulic Oil Filter Full Flow Spin-On
LINDE 000.983.06.01
GULDNER 9830618



H 1 : 140 (mm)
OD 1 : 76 (mm)
Thread Size : 3/4-16 UNF-2B
BPV (kg/cm2) : 3.3 - 3.7
Gasket Type : Square

CONT : 36
VOL : 0.039

HC-5903 Hydraulic Oil Filter Spin-On
TOYOTA 67512-41801-71



H 1 : 168 (mm)
OD 1 : 93 (mm)
Thread Size : 3/4-16 UNF-2B

CONT : 12
VOL : 0.026

HC-6501 Hydraulic Oil Filter Spin-On
GENERAL MOTORS 25010643



H 1 : 260 (mm)
OD 1 : 118 (mm)
Thread Size : 1 5/16"X12
Gasket Type : Square

CONT : 6
VOL : 0.029

Note : Performance grade uses HC-6502

HC-6901 Hydraulic Oil Filter Spin-On
INGERSOLL RAND 35296920



H 1 : 223 (mm)
OD 1 : 93.5 (mm)
Thread Size : 1 1/4"X12
Gasket Type : Square

CONT : 12
VOL : 0.034



Technical Specification

HC-69030 Hydraulic Oil Filter Spin-On

CASE 113465C1
INTERNATIONAL HARVESTER
113465C1



H 1 : 147.5 (mm)
OD 1 : 93 (mm)
Thread Size : 1 1/2"X16
Gasket Type : Square

CONT : 12
VOL : 0.024

Note : Glass Fiber media version uses HC-7925

HC-7101 Hydraulic Oil Filter Spin-On Synthetic Media

VOLVO 14532688



H 1 : 174 (mm)
OD 1 : 127 (mm)
Thread Size : M48X2

CONT : 6
VOL : 0.025

HC-7606 Hydraulic Oil Filter Spin-On Synthetic Media

JOHN DEERE AT103193



H 1 : 210 (mm)
OD 1 : 125 (mm)
Thread Size : 1 1/2"X16

CONT : 6
VOL : 0.026

Note : Is a long life version of HC-7601

HC-69031 Hydraulic Oil Filter Spin-On With Glass Fiber Media

HYUNDAI 46321-22015
INGERSOLL RAND 575129311
CATERPILLAR 77-5795



H 1 : 147.5 (mm)
OD 1 : 94 (mm)
Thread Size : 1 1/2"X16

CONT : 12
VOL : 0.022

Note : 5 micron

HC-7601 Hydraulic Oil Filter Spin-On

JOHN DEERE AT103193



H 1 : 210 (mm)
OD 1 : 125 (mm)
Thread Size : 1 1/2"X16
Gasket Type : Square

CONT : 6
VOL : 0.026

Note : Performance grade uses HC-7606

HC-76070 Hydraulic Oil Filter Spin-On Synthetic Media

JOHN DEERE AT-308274



H 1 : 294 (mm)
OD 1 : 118 (mm)
Thread Size : M90X2
Gasket Type : Square

CONT : 6
VOL : 0.032

HC-69040 Hydraulic Oil Filter Transmission Spin-On

DOOSAN A383013



H 1 : 78 (mm)
OD 1 : 93 (mm)
Thread Size : 13/16"X16
Gasket Type : Square

CONT : 12
VOL : 0.013

HC-7602 Hydraulic Oil Filter Spin-On Synthetic Media

EUCLID 12597989
JOHN DEERE RE45864



H 1 : 173 (mm)
OD 1 : 123 (mm)
Thread Size : 1 1/2"X16-2B

CONT : 6
VOL : 0.024

HC-76080 Hydraulic Oil Filter Spin-On Synthetic Media

CASE 1266751H2
CASE 294721A1
J.C.BAMFORD 32905501
NEW HOLLAND (CNH) 9821387
JOHN DEERE AL77061



H 1 : 152 (mm)
OD 1 : 94.5 (mm)
Thread Size : 1 3/8"X12

CONT : 12
VOL : 0.024

Note : with Glass Fiber Media

HC-69050 Hydraulic Oil Filter aluminium casting Spin-On Synthetic Media

INGERSOLL RAND 36897346
INGERSOLL RAND 39856836



H 1 : 293 (mm)
OD 1 : 116 (mm)
Thread Size : 1 3/4"X12

CONT : 6
VOL : 0.034

HC-7603 Hydraulic Oil Filter Spin-On Synthetic Media

FURUKAWA 1233914H2
HOUGH 1233914H2
INTERNATIONAL HARVESTER
1233914H2
KDCPARTS 1233914H2
KOMATSU 1233914H2



H 1 : 210 (mm)
OD 1 : 125 (mm)
Thread Size : 1 1/2"X16
Gasket Type : Round

CONT : 6
VOL : 0.024

HC-76090 Hydraulic Oil Filter Spin-On Synthetic Media

JOHN DEERE AT 182209



H 1 : 200 (mm)
OD 1 : 93 (mm)
Thread Size : 1"X12
Gasket Type : Square

CONT : 12
VOL : 0.030

HC-7001 Hydraulic Oil Filter Spin-On

GEHL 137359
NEW HOLLAND (CNH) 85802793



H 1 : 293 (mm)
OD 1 : 116 (mm)
Thread Size : 1 3/4"X12

CONT : 6
VOL : 0.034

HC-7604 Hydraulic Oil Filter Spin-On With Glass Fiber Media

JOHN DEERE AT140315



H 1 : 298 (mm)
OD 1 : 125 (mm)
Thread Size : 1 1/2"X16

CONT : 6
VOL : 0.037

HC-76100 Hydraulic Oil Filter Spin-On Synthetic Media

BOBCAT 6686926
JOHN DEERE AM102723



H 1 : 110 (mm)
OD 1 : 94.5 (mm)
Thread Size : 1 3/8"X12

CONT : 12
VOL : 0.018



Technical Specification

HC-76110 Hydraulic Oil Filter Spin-On

J.C.BAMFORD 4802409
ZF 750131012
JOHN DEERE AT179323



H 1 : 145.5 (mm)
OD 1 : 93 (mm)
Thread Size : 1"X12
Thread Nut Size : M24X1.5
ADBV : YES
Gasket Type : Square

CONT : 12
VOL : 0.025

HC-7901 Hydraulic Oil Filter Full Flow Spin-On

INTERNATIONAL HARVESTER
075912103
KOBELCO 2446U141S2



H 1 : 130 (mm)
OD 1 : 93 (mm)
Thread Size : 1 1/8-16 UNF-2B
Gasket Type : Round

CONT : 12
VOL : 0.019

Note : Seat assy zinc coating

HC-79081 Hydraulic Oil Filter Spin-On

MASSEY-FERGUSON 3581032M2



H 1 : 180 (mm)
H 2 : 165 (mm)
OD 1 : 136 (mm)
Thread Size : M42X2
Gasket Type : Square

CONT : 6
VOL : 0.029

Note : without stud version uses HC-7908

HC-76120 Hydraulic Oil Filter Spin-On

JOHN DEERE RE27284



H 1 : 148 (mm)
OD 1 : 93 (mm)
Thread Size : 1 1/2"X16
Gasket Type : Square

CONT : 12
VOL : 0.022

HC-7905 Hydraulic Oil Filter Spin-On

MC CORMICK (LANDINI-ARGO)
220272
UCC UC-MX-1518-410



H 1 : 147.5 (mm)
OD 1 : 93 (mm)
Thread Size : 3/4X14 BSP
Gasket Type : Square

CONT : 12
VOL : 0.022

HC-7909 Hydraulic Oil Filter Spin-On

CASE A161845



H 1 : 270 (mm)
OD 1 : 123 (mm)
Thread Size : 1 1/2"X16
Gasket Type : Square

CONT : 6
VOL : 0.036

HC-76130 Hydraulic Oil Filter Transmission Spin-On With Glass Fiber Media

ZF 0501323154
J.C.BAMFORD 32925905
CASE 8603535
CASE 87519452
JOHN DEERE AT336140



H 1 : 199 (mm)
OD 1 : 94.5 (mm)
Thread Size : 1 3/8"X12
Thread Stud Size : M24X1.5

CONT : 12
VOL : 0.030

HC-7906 Hydraulic Oil Filter Spin-On

J.C.BAMFORD 32/901701



H 1 : 178 (mm)
OD 1 : 128.8 (mm)
Thread Size : 1 1/4"X11
Gasket Type : Square

CONT : 6
VOL : 0.025

HC-7910 Hydraulic Oil Filter Spin-On

SAAB-SCANIA 1301696



H 1 : 115 (mm)
OD 1 : 96 (mm)
Thread Size : M23X1.5
ADBV : YES
Gasket Type : Square

CONT : 12
VOL : 0.021

Note : Glass Fiber media version uses HC-7920

HC-76140 Hydraulic Oil Filter Spin-On Synthetic Media

JOHN DEERE RE521420



H 1 : 171 (mm)
OD 1 : 128.5 (mm)
Thread Size : 1 5/8"X12

CONT : 6
VOL : 0.023

HC-7907 Hydraulic Oil Filter Spin-On Cellulose media

CASE 1966553C1



H 1 : 226 (mm)
OD 1 : 127 (mm)
Thread Size : 1 1/4"XBSP
Gasket Type : Square

CONT : 6
VOL : 0.032

Note : 35 micron

HC-7911 Hydraulic Oil Filter Spin-On

SOFIMAHYDRAULIC/MODINA
CA151EMCV1



H 1 : 147.5 (mm)
OD 1 : 93 (mm)
Thread Size : 3/4 BSP
Gasket Type : Square

CONT : 12
VOL : 0.022

HC-76150 Hydraulic Oil Filter Transmission Spin-On

JOHN DEERE LVA16054



H 1 : 100 (mm)
OD 1 : 76 (mm)
Thread Size : 3/4"X16 UNF-2B

CONT : 40
VOL : 0.031

HC-7908 Hydraulic Oil Filter Spin-On

MASSEY-FERGUSON 3581032M2



H 1 : 165 (mm)
OD 1 : 136 (mm)
Thread Size : M42X2
Gasket Type : Square

CONT : 6
VOL : 0.028

Note : with stud version uses HC-79081

HC-7913 Hydraulic Oil Filter Spin-On

CLARK 234099
CATERPILLAR 311980
J.C.BAMFORD 4110147
FIAT 906041007

















H 1 : 140 (mm)
OD 1 : 93.5 (mm)
Thread Size : 2"X16
Gasket Type : Square

CONT : 12
VOL : 0.022



Technical Specification

<p>HC-7914 Hydraulic Oil Filter Full Flow Spin-On</p> <p>YANMAR 172156-73700</p>  <p>H 1 : 100 (mm) OD 1 : 80 (mm) Thread Size : M20X1.5-6H ADBV : YES Gasket Type : Round</p> <p>CONT : 50 VOL : 0.041</p> <p>Note : for Yanmar SV08</p>	<p>HC-7922 Hydraulic Oil Filter Spin-On</p> <p>HAVAM HD0546</p>  <p>H 1 : 362 (mm) OD 1 : 116 (mm) Thread Size : 1 3/4"X12</p> <p>CONT : 6 VOL : 0.041</p>	<p>HC-7927 Hydraulic Oil Filter Spin-On</p> <p>CATERPILLAR 3I-0549 CASE N7332</p>  <p>H 1 : 240 (mm) OD 1 : 94.5 (mm) Thread Size : 1 3/8"X12</p> <p>CONT : 12 VOL : 0.036</p> <p>Note : Glass Fiber media uses HC-5504</p>
<p>HC-7915 Hydraulic Oil Filter Spin-On</p> <p>ISEKI 1614-508-262-00</p>  <p>H 1 : 131 (mm) OD 1 : 93 (mm) Thread Size : 1 1/8-16 UNF-2B Gasket Type : Round</p> <p>CONT : 25 VOL : 0.041</p>	<p>HC-7923 Hydraulic Oil Filter Spin-On With Glass Fiber Media</p> <p>CLARK 6599543 BOBCAT 6599543</p>  <p>H 1 : 152 (mm) OD 1 : 94.5 (mm) Thread Size : 1 3/8"X12 Gasket Type : Square</p> <p>CONT : 12 VOL : 0.024</p>	<p>HC-7928 Hydraulic Oil Filter Spin-On Synthetic Media</p> <p>SULLAIR 70324</p>  <p>H 1 : 178 (mm) OD 1 : 126.8 (mm) Thread Size : 1 1/4"X11 Gasket Type : Square</p> <p>CONT : 6 VOL : 0.023</p>
<p>HC-7916 Hydraulic Oil Filter Spin-On</p> <p>CAPA CH-165L</p>  <p>H 1 : 166 (mm) OD 1 : 80 (mm) Thread Size : 1 1/8-16 UNF-2B</p> <p>CONT : 12 VOL : 0.020</p>	<p>HC-7924 Hydraulic Oil Filter Spin-On Cellulose media</p> <p>ATLAS COPCO 1202-8040-00</p>  <p>H 1 : 214 (mm) OD 1 : 93 (mm) Thread Size : M20X1.5-6H Gasket Type : Square</p> <p>CONT : 12 VOL : 0.031</p> <p>Note : Glass fiber media version uses HC-7946</p>	<p>HC-7929 Hydraulic Oil Filter Spin-On</p> <p>JOHN DEERE AT120444</p>  <p>H 1 : 204 (mm) OD 1 : 94 (mm) Thread Size : 1 1/2"X16</p> <p>CONT : 12 VOL : 0.030</p> <p>Note : Performance grade uses HC-7939</p>
<p>HC-7919 Hydraulic Oil Filter Spin-On</p> <p>MAHINDRA 5556039R91</p>  <p>H 1 : 97 (mm) OD 1 : 93 (mm) Thread Size : 1"X12 BPV (kg/cm2) : 0.8 - 1.2 Gasket Type : Square</p> <p>CONT : 50 VOL : 0.055</p>	<p>HC-7925 Hydraulic Oil Filter Spin-On With Glass Fiber Media</p> <p>JOY 01228337-0020 PALL HC7400SUT4H</p>  <p>H 1 : 147.5 (mm) OD 1 : 93 (mm) Thread Size : 1 1/2"X16 Gasket Type : Square</p> <p>CONT : 12 VOL : 0.022</p> <p>Note : 20 micron</p>	<p>HC-7931 Hydraulic Oil Filter Wire Mesh supported Spin-On</p> <p>KUBOTA 35861-82630</p>  <p>H 1 : 175 (mm) OD 1 : 94 (mm) Thread Size : 1"X12 Gasket Type : Square</p> <p>CONT : 12 VOL : 0.027</p>
<p>HC-7920 Hydraulic Oil Filter Spin-On Synthetic Media</p> <p>SAAB-SCANIA 1301696</p>  <p>H 1 : 115 (mm) OD 1 : 96 (mm) Thread Size : M23X1.5 ADBV : YES Gasket Type : Square</p> <p>CONT : 12 VOL : 0.021</p>	<p>HC-7926 Hydraulic Oil Filter Spin-On</p> <p>ISEKI 1643-515-202-10</p>  <p>H 1 : 200 (mm) OD 1 : 108 (mm) Thread Size : 1 1/4"X12 Gasket Type : Square</p> <p>CONT : 12 VOL : 0.039</p> <p>Note : flow reverse</p>	<p>HC-7932 Hydraulic Oil Filter Wire Mesh supported Spin-On</p> <p>KUBOTA 36330-82630</p>  <p>H 1 : 149 (mm) OD 1 : 94 (mm) Thread Size : 1"X12 Gasket Type : Square</p> <p>CONT : 12 VOL : 0.023</p>



Technical Specification

HC-7933 Hydraulic Oil Filter Spin-On

MASSEY-FERGUSON 104309W91
VOLVO 12754597
CASE A45625



H 1 : 270 (mm)
OD 1 : 123 (mm)
Thread Size : 1 1/2"X16
Gasket Type : Square

CONT : 6
VOL : 0.036

Note : HC-7937(qty.outer packing difference)

HC-79372 Hydraulic Oil Filter Spin-On Synthetic Media

PALL HC7500SUS8H



H 1 : 270 (mm)
OD 1 : 123 (mm)
Thread Size : 1 1/2"X16
Gasket Type : Square

CONT : 6
VOL : 0.033

Note : High performance version of HC-7937

HC-7942 Hydraulic Oil Filter Spin-On

CAPA 93-P8244
CAPA CP-145VL-35



H 1 : 145 (mm)
OD 1 : 93 (mm)
Thread Size : 1 1/2"X16
Gasket Type : Square

CONT : 12
VOL : 0.021

HC-79331 Hydraulic Oil Filter Full Flow Spin-On

VOLVO 12754597



H 1 : 270 (mm)
OD 1 : 123 (mm)
Thread Size : 1 1/2"X16
Gasket Type : Square

CONT : 6
VOL : 0.039

Note : HC-7933 (qty.outer packing difference)

HC-7938 Hydraulic Oil Filter Spin-On

VOLVO 12754597
GENERAL MOTORS 25012488
CATERPILLAR 311664
JOHN DEERE AT58368



H 1 : 270 (mm)
OD 1 : 123 (mm)
Thread Size : 1 1/2"X16
Gasket Type : Square

CONT : 6
VOL : 0.033

HC-7943 Hydraulic Oil Filter Spin-On

CAPA 93-P8247
CAPA CP-175VL-25



H 1 : 175 (mm)
OD 1 : 93 (mm)
Thread Size : 1 1/2"X16

CONT : 12
VOL : 0.026

HC-7934 Hydraulic Oil Filter Spin-On

YAMASHIN 15510-00220



H 1 : 202 (mm)
OD 1 : 108 (mm)
Thread Size : 1 1/8-16 UNF-2B
Gasket Type : Square

CONT : 6
VOL : 0.020

HC-7939 Hydraulic Oil Filter Spin-On Synthetic Media

JOHN DEERE AT120444
PALL HC-7400SDT8H



H 1 : 204 (mm)
OD 1 : 94 (mm)
Thread Size : 1 1/2"X16
Gasket Type : Square

CONT : 12
VOL : 0.030

Note : HC-7929 (cellulose media),HC-7939(glass fiber media)

HC-7944 Hydraulic Oil Filter Spin-On Synthetic Media

YAMASHIN CSP-10-30



H 1 : 289 (mm)
OD 1 : 127 (mm)
Thread Size : M48X2

CONT : 6
VOL : 0.042

HC-7935 Hydraulic Oil Filter Full Flow Spin-On

GENERAL MOTORS 25010961
CATERPILLAR 310537
CHAR-LYNN 5610



H 1 : 130 (mm)
OD 1 : 93 (mm)
Thread Size : 1 1/4"X12

CONT : 12
VOL : 0.021

HC-7940 Hydraulic Oil Filter Spin-On

CASE 150794A1



H 1 : 136 (mm)
OD 1 : 93 (mm)
Thread Size : 1 1/8-16 UNF-2B
Gasket Type : Square

CONT : 12
VOL : 0.021

HC-7946 Hydraulic Oil Filter Spin-On Synthetic Media

ATLAS COPCO 1202-8040-00



H 1 : 214 (mm)
OD 1 : 93 (mm)
Thread Size : M20X1.5-6H
Gasket Type : Square

CONT : 12
VOL : 0.031

Note : Cellulose media verion uses HC-7924

HC-7937 Hydraulic Oil Filter Spin-On Cellulose media

PALL HC7500SUN8H
PALL HC7500SUS8H



H 1 : 270 (mm)
OD 1 : 123 (mm)
Thread Size : 1 1/2"X16
Gasket Type : Square

CONT : 6
VOL : 0.038

Note : mirron rating;nominal 16 micron,absolute 36 micron

HC-7941 Hydraulic Oil Filter Spin-On

CLARK 2366807



H 1 : 172 (mm)
OD 1 : 93.5 (mm)
Thread Size : 2"X16
Gasket Type : Square

CONT : 12
VOL : 0.026

HC-7947 Hydraulic Oil Filter Spin-On

HYDRO GEAR 51563

















H 1 : 90 (mm)
OD 1 : 76 (mm)
Thread Size : 3/4-16 UNF-2B
BPV (kg/cm²) : 0.8 - 1.2
ABDV : YES
Gasket Type : Square

CONT : 50
VOL : 0.030

















Technical Specification

<p>HC-79490 Hydraulic Oil Filter Spin-On Synthetic Media SULLAIR 250025-525</p>  <p>H 1 : 158 (mm) OD 1 : 118 (mm) Thread Size : 1 1/4"X11 BSP Gasket Type : Square</p> <p>CONT : 6 VOL : 0.021</p>	<p>HC-79550 Hydraulic Oil Filter Spin-On KUKJE TA00016986A</p>  <p>H 1 : 100 (mm) OD 1 : 80 (mm) Thread Size : 3/4-16 UNF-2B</p> <p>CONT : 50 VOL : 0.043</p>	<p>HC-7970 Hydraulic Oil Filter Spin-On CAPA CP-270</p>  <p>H 1 : 270 (mm) OD 1 : 108 (mm) Thread Size : 1 1/2"X16 Gasket Type : Square</p> <p>CONT : 6 VOL : 0.026</p>
<p>HC-79500 Hydraulic Oil Filter Spin-On CROSLAND 1A9023 GRESEN 8057000 JINMA JX0811A</p>  <p>H 1 : 135 (mm) OD 1 : 93 (mm) Thread Size : 1"X12 BPV (kg/cm2) : 0.8 - 1.2 Gasket Type : Square</p> <p>CONT : 25 VOL : 0.042</p>	<p>HC-7963 Hydraulic Oil Filter Spin-On ISEKI 1641-515-391-00</p>  <p>H 1 : 153 (mm) OD 1 : 108 (mm) Thread Size : 1 1/4"X12 Gasket Type : Square</p> <p>CONT : 12 VOL : 0.034</p>	<p>HC-7972 Hydraulic Oil Filter Spin-On With Glass Fiber Media CATERPILLAR 3I-1761 HITACHI 73131887 CASE D126922</p>  <p>H 1 : 240 (mm) OD 1 : 94.5 (mm) Thread Size : 1 3/8"X12</p> <p>CONT : 12 VOL : 0.035</p>
<p>HC-79520 Hydraulic Oil Filter Spin-On HYDAC 0160 MU 010P</p>  <p>H 1 : 178 (mm) OD 1 : 127 (mm) Thread Size : 1 1/2"X16 Gasket Type : Square</p> <p>CONT : 6 VOL : 0.028</p>	<p>HC-7964 Hydraulic Oil Filter Spin-On DEMAG 044 252 74 COMPRESSORS 98262/229</p>  <p>H 1 : 305 (mm) OD 1 : 136 (mm) Thread Size : 1 1/2"X16 Gasket Type : Square</p> <p>CONT : 6 VOL : 0.046</p>	<p>HC-7973 Hydraulic Oil Filter Spin-On Synthetic Media SULLAIR 250025-526</p>  <p>H 1 : 286 (mm) OD 1 : 118 (mm) Thread Size : 1 1/4"X11 BSP Gasket Type : Square</p> <p>CONT : 6 VOL : 0.032</p>
<p>HC-79530 Hydraulic Oil Filter Transmission Spin-On ISEKI 1759-508-402-00</p>  <p>H 1 : 250 (mm) OD 1 : 108 (mm) Thread Size : 1 1/2-12 UNF-2B Gasket Type : Square</p> <p>CONT : 12 VOL : 0.050</p> <p>Note : HST FILTER</p>	<p>HC-7965 Hydraulic Oil Filter Spin-On CASE 254686A1 CASE 254686A2 KOMATSU CA0139413</p>  <p>H 1 : 152 (mm) OD 1 : 93 (mm) Thread Size : 13/16"X16 Gasket Type : Square</p> <p>CONT : 12 VOL : 0.023</p>	<p>HC-7974 Hydraulic Oil Filter Spin-On MC CORMICK (LANDINI-ARGO) 4204121M1</p>  <p>H 1 : 191 (mm) OD 1 : 93 (mm) Thread Size : 3/4 BSP Gasket Type : Square</p> <p>CONT : 12 VOL : 0.029</p>
<p>HC-79540 Hydraulic Oil Filter Spin-On BRANSON NTB8030000B3</p>  <p>H 1 : 204 (mm) OD 1 : 94 (mm) Thread Size : 1 1/2"X16 Gasket Type : Square</p> <p>CONT : 12 VOL : 0.030</p>	<p>HC-7966 Hydraulic Oil Filter Wire Mesh supported Spin-On LEOSING 140131</p>  <p>H 1 : 226 (mm) OD 1 : 127 (mm) Thread Size : 1 1/4"X11 BSP Gasket Type : Square</p> <p>CONT : 6 VOL : 0.031</p>	<p>HC-7975 Hydraulic Oil Filter Spin-On KUBOTA 38430-3771-4</p>  <p>H 1 : 131 (mm) H 2 : 120 (mm) OD 1 : 80 (mm) Thread Size : M20X1.5-6H Gasket Type : Round</p> <p>CONT : 50 VOL : 0.056</p>



Technical Specification

<p>HC-8001 Hydraulic Oil Filter Spin-On</p> <p>CASE E-73298</p>  <p>H 1 : 133 (mm) OD 1 : 93 (mm) Thread Size : 1"X11 BSP</p> <p>CONT : 12 VOL : 0.021</p>	<p>HC-85210 Hydraulic Oil Filter Transmission Spin-On</p> <p>LINDNER 292760 LINDNER 735700733011</p>  <p>H 1 : 205 (mm) OD 1 : 93 (mm) Thread Size : M33X1.5</p> <p>CONT : 25 VOL : 0.055</p>	<p>HC-8805 Hydraulic Oil Filter Spin-On</p> <p>INTERPARTS KNJ0288</p>  <p>H 1 : 136 (mm) OD 1 : 93 (mm) Thread Size : 1 1/8"X16 UNS-2B Gasket Type : Square</p> <p>CONT : 12 VOL : 0.022</p>
<p>HC-8501 Hydraulic Oil Filter Spin-On</p> <p>J.C.BAMFORD 581/18063</p>  <p>H 1 : 98 (mm) OD 1 : 93 (mm) Thread Size : 1"X12 BPV (kg/cm2) : 0.8 - 1.2 ADBV : YES Gasket Type : Square</p> <p>CONT : 36 VOL : 0.041</p>	<p>HC-88010 Hydraulic Oil Filter Spin-On</p> <p>KUBOTA 67955-37710</p>  <p>H 1 : 120 (mm) OD 1 : 80 (mm) Thread Size : M20X1.5-6H Gasket Type : Round</p> <p>CONT : 25 VOL : 0.026</p>	<p>HC-88060 Hydraulic Oil Filter Spin-On</p> <p>KUBOTA 32701-37950</p>  <p>H 1 : 130 (mm) OD 1 : 93 (mm) Thread Size : 1 1/8-16 UNF-2B Gasket Type : Round</p> <p>CONT : 25 VOL : 0.038</p>
<p>HC-8502 Hydraulic Oil Filter Spin-On With Glass Fiber Media</p> <p>QUINCY 142136</p>  <p>H 1 : 199 (mm) OD 1 : 118 (mm) Thread Size : 1 1/4"X11 BSP Gasket Type : Square</p> <p>CONT : 6 VOL : 0.022</p>	<p>HC-88020 Hydraulic Oil Filter Spin-On</p> <p>KUBOTA HHTA0-59900</p>  <p>H 1 : 145 (mm) OD 1 : 91.6 (mm) Thread Size : 1 1/8-16 UNF-2B</p> <p>CONT : 12 VOL : 0.022</p> <p>Note : with glass fiber media</p>	<p>HC-8811 Hydraulic Oil Filter Spin-On With Magnet</p> <p>KUBOTA 3A431-82623 KUBOTA 3A431-82632</p>  <p>H 1 : 102 (mm) OD 1 : 94 (mm) Thread Size : 1 1/8-16 UNF-2B Gasket Type : Square</p> <p>CONT : 12 VOL : 0.018</p>
<p>HC-85030 Hydraulic Oil Filter Spin-On Synthetic Media</p> <p>SULLAIR 250026-982</p>  <p>H 1 : 136 (mm) OD 1 : 93 (mm) Thread Size : 31/32"X20 Gasket Type : Square</p> <p>CONT : 12 VOL : 0.021</p>	<p>HC-88030 Hydraulic Oil Filter Suction Spin-On</p> <p>KUBOTA HH3Y0-82590 KUBOTA HH3Y0-82591</p>  <p>H 1 : 230 (mm) OD 1 : 125 (mm) Thread Size : M38X2.0</p> <p>CONT : 6 VOL : 0.030</p> <p>Note : with magnet</p>	<p>HC-88111 Hydraulic Oil Filter Spin-On</p> <p>KUBOTA HH3A0-82630 KUBOTA W21TSH3A10</p>  <p>H 1 : 102 (mm) OD 1 : 94 (mm) Thread Size : 1 1/8-16 UNF-2B Gasket Type : Square</p> <p>CONT : 12 VOL : 0.016</p> <p>Note : Without magnet</p>
<p>HC-85190 Hydraulic Oil Filter Spin-On</p> <p>FILTREC AWP-105</p>  <p>H 1 : 139 (mm) OD 1 : 93 (mm) Thread Size : 1 1/8-16 UNF-2B Gasket Type : Square</p> <p>CONT : 12 VOL : 0.020</p>	<p>HC-8804 Hydraulic Oil Filter Spin-On</p> <p>KUBOTA 32701-37951</p>  <p>H 1 : 145 (mm) OD 1 : 94 (mm) Thread Size : 1 1/8-16 UNF-2B Gasket Type : Square</p> <p>CONT : 12 VOL : 0.023</p>	<p>HC-88210 Hydraulic Oil Filter Transmission Spin-On</p> <p>KUBOTA HHK70-14070 KUBOTA K7561-14070</p>  <p>H 1 : 100 (mm) OD 1 : 80 (mm) Thread Size : 3/4-16 UNF-2B ADBV : YES Gasket Type : Square</p> <p>CONT : 12 VOL : 0.011</p>



HC-9901

Hydraulic Oil Filter Spin-On

CATERPILLAR 5I-8670



H 1 : 155 (mm)
OD 1 : 82.5 (mm)
Thread Size : M45X2.0-6H
Gasket Type : Round

CONT : 12
VOL : 0.019

TC-7918

Hydraulic Oil Filter Transmission Spin-On

HYSTER 309112
YALE & TOWNE 505966578



H 1 : 110 (mm)
OD 1 : 93 (mm)
Thread Size : 3/4-16 UNF-2B
BPV (kg/cm²) : 0.8 - 1.2
ADBV : YES
Gasket Type : Square

CONT : 36
VOL : 0.048

Note : TC-79060(bottom plate difference)



Engine Application

C



ENGINE APPLICATION

MODEL/APPLICATION	SAKURA NO	MODEL/APPLICATION	SAKURA NO	MODEL/APPLICATION	SAKURA NO
ABG(VOLVO CE)		ABG(VOLVO CE)		AGCHEMEQ	
PUMA 168A (CONSTRUCTION & MINING) DEUTZ F3L912 , 1975-1990		Titan 511 (AGRICULTURE) DEUTZ BF6L913 , 1987		844 RO-GATOR (EQUIPMENT) CUMMINS 6BTA5.9 , 1995-1996	
Hydraulic Oil Filter.....	HC-7906	Hydraulic Oil Filter.....	HC-7906	Hydraulic Oil Filter.....	HC-55260
Hydraulic Oil Filter.....	HC-7906			Hydraulic Oil Filter.....	HC-5516
PUMA 168A (CONSTRUCTION EQUIPMENTS) F3L912 - DEUTZ		AGCHEMEQ		854 RO-GATOR (AGRICULTURE) 1999-2002	
Hydraulic Oil Filter.....	HC-7906	1004 AG-GATOR (APPLICATORS/SPREADERS) CUMMINS		Hydraulic Oil Filter.....	HC-5504
PUMA 177VS (CONSTRUCTION & MINING) DEUTZ F6L912 , 1975-1990		Hydraulic Oil Filter.....	HC-7932	854 RO-GATOR (AGRICULTURE) 1997-1998	
Hydraulic Oil Filter.....	HC-7906	1004 (APPLICATORS/SPREADERS) CUMMINS		Hydraulic Oil Filter.....	HC-5504
Hydraulic Oil Filter.....	HC-7906	Hydraulic Oil Filter.....	HC-7932	874 RO-GATOR (EQUIPMENT) CAT 3126B	
PUMA 177VS (CONSTRUCTION EQUIPMENTS) F6L912 - DEUTZ		1254 (AGRICULTURE) 2002		Hydraulic Oil Filter.....	HC-5504
Hydraulic Oil Filter.....	HC-7906	Hydraulic Oil Filter.....	HC-5504	A-2500 (EQUIPMENT) AGCHEMEQ 504 V8	
PUMA 178A (CONSTRUCTION EQUIPMENTS) F6L912 - DEUTZ		1254 (AGRICULTURE) 2000-2001		Hydraulic Oil Filter.....	H-79411
Hydraulic Oil Filter.....	HC-7906	Hydraulic Oil Filter.....	HC-5504	A-2500 (EQUIPMENT) CUMMINS V-555	
PUMA A78A (CONSTRUCTION & MINING) DEUTZ F6L912		1253 TERRA-GATOR (EQUIPMENT) CAT 3208		Hydraulic Oil Filter.....	H-79411
Hydraulic Oil Filter.....	HC-7906	Hydraulic Oil Filter.....	H-79411	SS1074 RO-GATOR (EQUIPMENT) CAT 3126B	
Hydraulic Oil Filter.....	HC-7906	1253 TERRA-GATOR (EQUIPMENT) CUMMINS V-555		Hydraulic Oil Filter.....	HC-5504
Titan 211 (AGRICULTURE) DEUTZ F5L912 , 1988		Hydraulic Oil Filter.....	H-79411	AGCO	
Hydraulic Oil Filter.....	HC-7906	1254 Ro-Gator (EQUIPMENT) CUMMINS ISB5.9		8745 (TRACTORS) CUMMINS 3.9L	
Titan 222 (AGRICULTURE) DEUTZ F5L912 , 1990		Hydraulic Oil Filter.....	HC-5504	Hydraulic Oil Filter.....	H-7916
Hydraulic Oil Filter.....	HC-7906	1604 TERRA-TRUCK (APPLICATORS/SPREADERS) 3208 - CATERPILLAR		8775 (AGRICULTURE) CUMMINS CUMMINS	
Titan 311 (AGRICULTURE) DEUTZ BF6L913 , 1988		Hydraulic Oil Filter.....	HC-5511	Hydraulic Oil Filter.....	H-7916
Hydraulic Oil Filter.....	HC-7906	1604 TERRA-TRUCK (APPLICATORS/SPREADERS) 3208N - CATERPILLAR		8775 (AGRICULTURE) CUMMINS CUMMINS	
Titan 311 (AGRICULTURE) DEUTZ F6L913 , 1988		Hydraulic Oil Filter.....	HC-5511	Hydraulic Oil Filter.....	H-7916
Hydraulic Oil Filter.....	HC-7906	5140 (APPLICATORS/SPREADERS) 903 - CUMMINS		8775 (AGRICULTURE) VALMET VALMET	
Titan 322 (AGRICULTURE) DEUTZ BF6L913 , 1990		Hydraulic Oil Filter.....	HC-7932	Hydraulic Oil Filter.....	H-7916
Hydraulic Oil Filter.....	HC-7906	5140 (APPLICATORS/SPREADERS) V903 - CUMMINS		8775 (TRACTORS) CUMMINS	
Titan 355 (AGRICULTURE) DEUTZ F6L913 , 1988		Hydraulic Oil Filter.....	HC-7932	Hydraulic Oil Filter.....	H-7916
Hydraulic Oil Filter.....	HC-7906	544 RO-GATOR (AGRICULTURE) CUMMINS 4B3.9		8775 (TRACTORS) VALMET	
Titan 411 (AGRICULTURE) DEUTZ F6L413 , 1988-1992		Hydraulic Oil Filter.....	HC-5504	Hydraulic Oil Filter.....	H-7916
Hydraulic Oil Filter.....	HC-7906	Hydraulic Oil Filter.....	HC-5516	8785 (AGRICULTURE) CUMMINS CUMMINS	
Titan 422 (AGRICULTURE) DEUTZ F6L413 , 1990		Hydraulic Oil Filter.....	HC-5504	Hydraulic Oil Filter.....	H-7916
Hydraulic Oil Filter.....	HC-7906	554 RO-GATOR (EQUIPMENT) CUMMINS 6BT5.9		9330 (COMBINES) CUMMINS B3.3T	
Titan 455 (AGRICULTURE) DEUTZ F6L913 , 1990		Hydraulic Oil Filter.....	HC-5516	Hydraulic Oil Filter.....	HC-5511
Hydraulic Oil Filter.....	HC-7906	Hydraulic Oil Filter.....	HC-5504	9435 (TRACTORS)	
Titan 511 (AGRICULTURE) DEUTZ BF5L513 , 1988		663 RO-GATOR (EQUIPMENT) CUMMINS 6BTA5.9		Hydraulic Oil Filter.....	H-7916
Hydraulic Oil Filter.....	HC-7906	Hydraulic Oil Filter.....	HC-55260		
		Hydraulic Oil Filter.....	HC-55260		



ENGINE APPLICATION

MODEL/APPLICATION	SAKURA NO	MODEL/APPLICATION	SAKURA NO	MODEL/APPLICATION	SAKURA NO
AGCO		AGCO		AGCO	
9675 (TRACTORS)		DT200 (AGRICULTURE) CUMMINS CUMMINS		RT135 (TRACTORS) CUMMINS 6.7L	
Hydraulic Oil Filter.....	HC-5508	Hydraulic Oil Filter.....	H-7916	Hydraulic Oil Filter.....	H-5001
9735 (AGRICULTURE) CUMMINS CUMMINS		DT225 (AGRICULTURE) CUMMINS CUMMINS		RT95 (AGRICULTURE) CUMMINS CUMMINS	
Hydraulic Oil Filter.....	H-7916	Hydraulic Oil Filter.....	H-7916	Hydraulic Oil Filter.....	H-7916
9735 (AGRICULTURE) VALMET VALMET		DT225 (TRACTORS) CUMMINS		VALMET (AGRICULTURE) VALMET	
Hydraulic Oil Filter.....	H-7916	Hydraulic Oil Filter.....	H-7916	Hydraulic Oil Filter.....	H-7916
9735 (TRACTORS) CUMMINS		EAGLE 8500 (SPRAYERS) CUMMINS 5.9L		AGCO ALLIS	
Hydraulic Oil Filter.....	H-7916	Hydraulic Oil Filter.....	HC-5516	4650 (TRACTORS) 4650	
9735 (TRACTORS) VALMET		Hydraulic Oil Filter.....	HC-55260	Hydraulic Oil Filter.....	HC-51040
Hydraulic Oil Filter.....	H-7916	EAGLE 8600 (SPRAYERS) CUMMINS 8.3L		4660 (TRACTORS) SLH 3-190	
9745 (AGRICULTURE) CUMMINS CUMMINS		Hydraulic Oil Filter.....	HC-5516	Hydraulic Oil Filter.....	HC-51040
Hydraulic Oil Filter.....	H-7916	R42 (COMBINES) CUMMINS 6CTA8.3		9435 (AGRICULTURE) 9435	
9745 (AGRICULTURE) VALMET VALMET		Hydraulic Oil Filter.....	H-7936	Hydraulic Oil Filter.....	H-7916
Hydraulic Oil Filter.....	H-7916	R52 (AGRICULTURE) CUMMINS 6CTA8.3		9435 (TRACTORS)	
9755 (AGRICULTURE) CUMMINS CUMMINS		Hydraulic Oil Filter.....	H-7936	Hydraulic Oil Filter.....	H-7916
Hydraulic Oil Filter.....	H-7916	Hydraulic Oil Filter.....	H-7936	9455 (AGRICULTURE) 9455	
9755 (AGRICULTURE) VALMET VALMET		R60 (COMBINES) DEUTZ F8L513		Hydraulic Oil Filter.....	H-7916
Hydraulic Oil Filter.....	H-7916	Hydraulic Oil Filter.....	H-7936	9635 (TRACTORS)	
9755 (TRACTORS) CUMMINS		R62 (COMBINES) CUMMINS 6CTA8.3		Hydraulic Oil Filter.....	HC-5508
Hydraulic Oil Filter.....	H-7916	Hydraulic Oil Filter.....	HC-5504	9650 (TRACTORS)	
9755 (TRACTORS) VALMET		R65 (COMBINES) CUMMINS OSC8.3		Hydraulic Oil Filter.....	HC-5508
Hydraulic Oil Filter.....	H-7916	Hydraulic Oil Filter.....	HC-5504	9675 (TRACTORS)	
9765 (AGRICULTURE) CUMMINS CUMMINS		R-75 (COMBINES) CUMMINS M11		Hydraulic Oil Filter.....	HC-5508
Hydraulic Oil Filter.....	H-7916	Hydraulic Oil Filter.....	HC-55290	9670 (TRACTORS)	
9775 (AGRICULTURE) CUMMINS CUMMINS		Hydraulic Oil Filter.....	HC-5504	Hydraulic Oil Filter.....	HC-5508
Hydraulic Oil Filter.....	H-7916	RT115 (AGRICULTURE) CUMMINS CUMMINS		9815 (TRACTORS)	
9785 (AGRICULTURE) CUMMINS CUMMINS		Hydraulic Oil Filter.....	H-7916	Hydraulic Oil Filter.....	HC-5508
Hydraulic Oil Filter.....	H-7916	RT115 (TRACTORS) CUMMINS		AGRIFUL	
9815 (TRACTORS)		Hydraulic Oil Filter.....	H-7916	A140 (TRACTORS)	
Hydraulic Oil Filter.....	HC-5508	RT130 (AGRICULTURE) CUMMINS CUMMINS		Hydraulic Oil Filter.....	HC-45110
DT160 (AGRICULTURE) CUMMINS CUMMINS		Hydraulic Oil Filter.....	H-7916	A55 (TRACTORS)	
Hydraulic Oil Filter.....	H-7916	RT130 (TRACTORS) CUMMINS		Hydraulic Oil Filter.....	HC-45110
DT160 (TRACTORS) CUMMINS		Hydraulic Oil Filter.....	H-7916	A65 (TRACTORS)	
Hydraulic Oil Filter.....	H-7916	RT145 (AGRICULTURE) CUMMINS CUMMINS		Hydraulic Oil Filter.....	HC-45110
		Hydraulic Oil Filter.....	H-7916		



ENGINE APPLICATION

MODEL/APPLICATION	SAKURA NO	MODEL/APPLICATION	SAKURA NO	MODEL/APPLICATION	SAKURA NO
AGRIFUL		AHLMANN		ALLIS CHALMERS	
A90 (TRACTORS)		AS7CS (CONSTRUCTION & MINING) KHD F4L913		Hydraulic Oil Filter.....	H-7976
Hydraulic Oil Filter.....	HC-45110	Hydraulic Oil Filter.....	HC-1822	260B (CONSTRUCTION EQUIPMENTS)	
AHLMANN		AZ10 (EXCAVATORS)		Hydraulic Oil Filter.....	H-5503
AL6 (CONSTRUCTION & MINING) KHD F2L511		Hydraulic Oil Filter.....	H-7991	260E Series A (CONSTRUCTION EQUIPMENTS) S/N: 8001-0N	
Hydraulic Oil Filter.....	H-4904	AZ45 (EXCAVATORS) KHD F3L1011F		Hydraulic Oil Filter.....	H-7976
Hydraulic Oil Filter.....	H-4904	Hydraulic Oil Filter.....	H-7991	261B (CONSTRUCTION EQUIPMENTS)	
AL6B (CONSTRUCTION & MINING) KHD F2L511		AIRMAN		Hydraulic Oil Filter.....	H-5503
Hydraulic Oil Filter.....	H-4904	AX52-U5 (CONSTRUCTION & MINING)		262B (CONSTRUCTION EQUIPMENTS)	
AL7 (CONSTRUCTION & MINING) KHD F2L511		Hydraulic Oil Filter.....	H-27370	Hydraulic Oil Filter.....	H-5503
Hydraulic Oil Filter.....	H-4904	SAS 37P55 (AIR COMPRESSORS) 2000		263B (CONSTRUCTION EQUIPMENTS)	
AL7C (CONSTRUCTION & MINING) KHD F2L511		Hydraulic Oil Filter.....	HC-5804	Hydraulic Oil Filter.....	H-5503
Hydraulic Oil Filter.....	H-4904	SAS 37S-66 (AIR COMPRESSORS) 2005		31 (TRACTORS) CUMMINS	
AL7D (EXCAVATORS)		Hydraulic Oil Filter.....	HC-5804	Hydraulic Oil Filter.....	H-5503
Hydraulic Oil Filter.....	H-7991	SAS.37P.55 (AIR COMPRESSORS) 1998		41 (TRACTORS) V12 - CUMMINS	
AL8 (CONSTRUCTION & MINING) KHD F2L511		Hydraulic Oil Filter.....	HC-5804	Hydraulic Oil Filter.....	H-5503
Hydraulic Oil Filter.....	H-4904	ALBARET		41B (TRACTORS) VT1710C - CUMMINS	
AL8C (EXCAVATORS) KHD F3L912		P5 (CONSTRUCTION EQUIPMENTS) CAT 3208		Hydraulic Oil Filter.....	H-5503
Hydraulic Oil Filter.....	H-51170	Hydraulic Oil Filter Transmission....	H-5109	440 (AGRICULTURE) CUMMINS CUMMINS	
Hydraulic Oil Filter.....	H-7991	ALLIS CHALMERS		Hydraulic Oil Filter.....	HC-7932
AL8C (EXCAVATORS) KHD F3L913		161 (CONSTRUCTION EQUIPMENTS)		440 (TRACTORS) CUMMINS	
Hydraulic Oil Filter.....	H-51170	Hydraulic Oil Filter.....	H-5503	Hydraulic Oil Filter.....	HC-7932
Hydraulic Oil Filter.....	H-7991	21C (TRACTORS) 2100 MK II		45 (GRADERS) 10000	
AS 10, 10S (AGRICULTURE) DEUTZ BF4L913		Hydraulic Oil Filter.....	H-5503	Hydraulic Oil Filter.....	H-5503
Hydraulic Oil Filter.....	HC-6802	260E (CONSTRUCTION EQUIPMENTS) S/N: 8001		45 (GRADERS) 10000 - ALLIS CHALMERS	
AS10 (PUMPS) KHD BF4L413		Hydraulic Oil Filter.....	H-7976	Hydraulic Oil Filter.....	H-5503
Hydraulic Oil Filter.....	HC-6802	260 (CONSTRUCTION EQUIPMENTS) 16000		45 (GRADERS) AD5516	
AS150 (LOADERS) KHD BF4M2012EC , 2001-UP		Hydraulic Oil Filter.....	H-7976	Hydraulic Oil Filter.....	H-5503
Hydraulic Oil Filter.....	HC-1822	260 (CONSTRUCTION EQUIPMENTS) 16000 - ALLIS CHALMERS		460 (CONSTRUCTION EQUIPMENTS)	
AS150 (CONSTRUCTION & MINING) KHD BF4M2012EC , 2001		Hydraulic Oil Filter.....	H-7976	Hydraulic Oil Filter.....	H-5517
Hydraulic Oil Filter.....	HC-1822	260 (CONSTRUCTION EQUIPMENTS) 19000		Hydraulic Oil Filter Transmission...	H-65030
AS 4 (EXCAVATORS) KHD BF3L1011 , 1990-UP		Hydraulic Oil Filter.....	H-7976	Hydraulic Oil Filter.....	H-7976
Hydraulic Oil Filter.....	H-7991	260 (CONSTRUCTION EQUIPMENTS) S/N: 4001		460 SERIES C (CONSTRUCTION EQUIPMENTS) 12V-71 - DETROIT	
AS7C (CONSTRUCTION & MINING) KHD F4L913		Hydraulic Oil Filter.....	H-7976	Hydraulic Oil Filter.....	H-5517
Hydraulic Oil Filter.....	HC-1822	260A (CONSTRUCTION EQUIPMENTS)		Hydraulic Oil Filter.....	H-7976
Hydraulic Oil Filter.....	HC-1822	Hydraulic Oil Filter.....	H-7976	460 SERIES C (CONSTRUCTION EQUIPMENTS) 12V-71 - GM	
				Hydraulic Oil Filter.....	H-7976



ENGINE APPLICATION

MODEL/APPLICATION	SAKURA NO	MODEL/APPLICATION	SAKURA NO	MODEL/APPLICATION	SAKURA NO
ALLIS CHALMERS		ALLIS CHALMERS		ALLIS CHALMERS	
460 SERIES C (CONSTRUCTION EQUIPMENTS) 12V-71 - GM		Hydraulic Oil Filter.....	H-7601	860XTB STRIPPER (AGRICULTURE)	
460 SERIES C (SCRAPERS) DETROIT 12V-71		7040 (TRACTORS)		Hydraulic Oil Filter.....	HC-7932
Hydraulic Oil Filter.....	H-7976	Hydraulic Oil Filter.....	H-5501	Hydraulic Oil Filter.....	HC-7932
Hydraulic Oil Filter Transmission...	H-65030	7060 (TRACTORS)		918 (BACKHOE LOADERS) 2800	
460 Series B (CONSTRUCTION EQUIPMENTS)		Hydraulic Oil Filter.....	H-5501	Hydraulic Oil Filter.....	H-7941
Hydraulic Oil Filter.....	H-5517	745TB (FORKLIFTS)		918 (BACKHOE LOADERS) 2800 - ALLIS CHALMERS	
Hydraulic Oil Filter Transmission...	H-65030	Hydraulic Oil Filter.....	H-5503	Hydraulic Oil Filter.....	H-7941
Hydraulic Oil Filter.....	H-7976	816 (BACKHOE LOADERS) Perkins 4.248		918 (BACKHOE LOADERS) ALLISCHA 2800	
5020 (TRACTORS)		Hydraulic Oil Filter.....	H-51170	Hydraulic Oil Filter.....	H-79411
Hydraulic Oil Filter.....	H-7601	840 (BACKHOE LOADERS) 2800		940 (BACKHOE LOADERS) 2900	
540 (BACKHOE LOADERS) FORD 172 DIESEL		Hydraulic Oil Filter.....	H-6902	Hydraulic Oil Filter.....	H-6902
Hydraulic Oil Filter.....	H-51170	840 (BACKHOE LOADERS) 2800 - ALLIS CHALMERS		CH (COMBINES - HARVESTERS)	
540 (BACKHOE LOADERS) FORD 172 GAS		Hydraulic Oil Filter.....	H-6902	Hydraulic Oil Filter Full Flow.....	HC-7901
Hydraulic Oil Filter.....	H-51170	840 (BACKHOE LOADERS) ALLISCHA 2800		CH (COMBINES - HARVESTERS) Propane/LPG	
555 (BACKHOE LOADERS) 21000		Hydraulic Oil Filter.....	H-7961	Hydraulic Oil Filter Full Flow.....	HC-7901
Hydraulic Oil Filter.....	H-5517	840 (BACKHOE LOADERS) PERKINS		D-40 (TRACTORS) 21000H	
Hydraulic Oil Filter.....	H-6902	Hydraulic Oil Filter.....	H-7961	Hydraulic Oil Filter.....	H-6902
555 (BACKHOE LOADERS) 21000 - ALLIS CHALMERS		Hydraulic Oil Filter.....	H-6902	D-560 (CONSTRUCTION EQUIPMENTS) 21000	
Hydraulic Oil Filter.....	H-6902	840 (CONSTRUCTION & MINING) ALLISCHA 2800		Hydraulic Oil Filter.....	H-5517
Hydraulic Oil Filter.....	H-5517	Hydraulic Oil Filter.....	H-7961	D-560 (CONSTRUCTION EQUIPMENTS) 21000 - ALLIS CHALMERS	
555 (BACKHOE LOADERS) 25000		840 (CONSTRUCTION & MINING) PERKINS PERKINS		Hydraulic Oil Filter.....	H-5517
Hydraulic Oil Filter.....	H-5517	Hydraulic Oil Filter.....	H-7961	D-560 (CONSTRUCTION EQUIPMENTS) 25000	
555 (BACKHOE LOADERS) 25000 - ALLIS CHALMERS		840B (BACKHOE LOADERS) 2800		Hydraulic Oil Filter.....	H-5517
Hydraulic Oil Filter.....	H-5517	Hydraulic Oil Filter.....	H-6902	D-560 (CONSTRUCTION EQUIPMENTS) 25000 - ALLIS CHALMERS	
560 (CONSTRUCTION EQUIPMENTS) 21000		840B (BACKHOE LOADERS) 2800 - ALLIS CHALMERS		Hydraulic Oil Filter.....	H-5517
Hydraulic Oil Filter.....	H-5517	Hydraulic Oil Filter.....	H-6902	D-562 (CONSTRUCTION EQUIPMENTS) 21000	
560 (CONSTRUCTION EQUIPMENTS) 21000 - ALLIS CHALMERS		840B (BACKHOE LOADERS) PERKINS		Hydraulic Oil Filter.....	H-5517
Hydraulic Oil Filter.....	H-5517	Hydraulic Oil Filter.....	H-6902	D-562 (CONSTRUCTION EQUIPMENTS) 21000 - ALLIS CHALMERS	
560 (CONSTRUCTION EQUIPMENTS) 25000		840B (CONSTRUCTION & MINING) ALLISCHA 2800		Hydraulic Oil Filter.....	H-5517
Hydraulic Oil Filter.....	H-5517	Hydraulic Oil Filter.....	H-7961	D-562 (CONSTRUCTION EQUIPMENTS) 25000	
560 (CONSTRUCTION EQUIPMENTS) 25000 - ALLIS CHALMERS		840B (CONSTRUCTION & MINING) PERKINS PERKINS		Hydraulic Oil Filter.....	H-5517
Hydraulic Oil Filter.....	H-5517	Hydraulic Oil Filter.....	H-7961	D-562 (CONSTRUCTION EQUIPMENTS) 25000 - ALLIS CHALMERS	
7000 (TRACTORS) HD7G		860 (AGRICULTURE)		Hydraulic Oil Filter.....	H-5517
Hydraulic Oil Filter.....	H-6902	Hydraulic Oil Filter.....	HC-7932	F (COMBINES)	
7020 (TRACTORS)		Hydraulic Oil Filter.....	HC-1903		
Hydraulic Oil Filter.....		Hydraulic Oil Filter.....	HC-7932		



ENGINE APPLICATION

MODEL/APPLICATION	SAKURA NO	MODEL/APPLICATION	SAKURA NO	MODEL/APPLICATION	SAKURA NO
ALLIS CHALMERS		ALLIS CHALMERS		ALLIS CHALMERS	
F (COMBINES)		HD-15 (TRACTORS) 6-71N - DETROIT		Hydraulic Oil Filter.....	H-6902
Hydraulic Oil Filter.....	H-51170	Hydraulic Oil Filter.....	H-6902	L (COMBINES) ALLISCHA 3500	
F2 (COMBINES)		HD-15C (CONSTRUCTION EQUIPMENTS) 6-71 - DETROIT		Hydraulic Oil Filter.....	H-51170
Hydraulic Oil Filter.....	H-51170	Hydraulic Oil Filter.....	H-6902	L (COMBINES) ALLISCHA 2900 MKII DIESEL	
F3 (COMBINES - HARVESTERS) 4-33I - ALLIS CHALMERS		HD-15C (TRACTORS) 6-71N - DETROIT		Hydraulic Oil Filter.....	H-51170
Hydraulic Oil Filter.....	HC-7932	Hydraulic Oil Filter.....	H-6902	L2 (COMBINES - HARVESTERS) 6/49	
FD30 (TRACTORS)		HD-15G (CONSTRUCTION EQUIPMENTS) 6-71 - DETROIT		Hydraulic Oil Filter.....	HC-7932
Hydraulic Oil Filter.....	H-5503	Hydraulic Oil Filter.....	H-6902	L2 (COMBINES - HARVESTERS) D2900	
FD30B (TRACTORS) CUMMINS		HD-15G (TRACTORS) 6-71N - DETROIT		Hydraulic Oil Filter.....	HC-7932
Hydraulic Oil Filter.....	H-5503	Hydraulic Oil Filter.....	H-6902	L2 (COMBINES) ALLISCHA 2900 MK11 DIESEL	
FD30B (TRACTORS) FIAT		HD-20 (CONSTRUCTION EQUIPMENTS) 6-71 - DETROIT		Hydraulic Oil Filter.....	H-51170
Hydraulic Oil Filter.....	H-5503	Hydraulic Oil Filter.....	H-6902	L3 (COMBINES - HARVESTERS)	
FD40 (TRACTORS) CUMMINS		HD-20 (TRACTORS) 6-71N - DETROIT		Hydraulic Oil Filter.....	HC-7932
Hydraulic Oil Filter.....	H-5503	Hydraulic Oil Filter.....	H-6902	M (COMBINES) ALLISCHA 2900 MK 11 DIESEL	
FD50 (TRACTORS) VT1710 - CUMMINS		HD-21 (TRACTORS) S/N 12800		Hydraulic Oil Filter.....	H-51170
Hydraulic Oil Filter.....	H-5503	Hydraulic Oil Filter.....	H-6902	M (COMBINES) ALLISCHA 2900 MK1 DIESEL	
FR11 (TOOLCARRIERS)		HD-4 (TRACTORS) D2200		Hydraulic Oil Filter.....	H-51170
Hydraulic Oil Filter.....	H-5503	Hydraulic Oil Filter.....	H-5501	M2 (COMBINES) ALLISCHA 2900 MK11S DIESEL	
FR10 (LOADERS) w/Fiat 8065 Eng.		HD-41B (AGRICULTURE) CUMMINS VT-1710		Hydraulic Oil Filter.....	H-51170
Hydraulic Oil Filter.....	HC-6502	Hydraulic Oil Filter.....	H-5503	M65 (GRADERS) D-262 - ALLIS CHALMERS	
FR15 (LOADERS)		HD-41B (TRACTORS) VT1710 - CUMMINS		Hydraulic Oil Filter.....	HC-7913
Hydraulic Oil Filter.....	HC-6502	Hydraulic Oil Filter.....	H-5503	M65 (GRADERS) G226	
FR12 (LOADERS)		HD-5 (TRACTORS) DETROIT		Hydraulic Oil Filter.....	HC-7913
Hydraulic Oil Filter.....	HC-6502	Hydraulic Oil Filter.....	H-6902	MH (COMBINES) ALLISCHA 3500 DIESEL	
FR20 (LOADERS)		HD-5G (TRACTORS) DETROIT		Hydraulic Oil Filter.....	H-51170
Hydraulic Oil Filter.....	HC-6502	Hydraulic Oil Filter.....	H-6902	N6-670HI (COMBINES)	
HD-11G (CONSTRUCTION EQUIPMENTS) 11000		HD-6G (TRACTORS) 6000		Hydraulic Oil Filter.....	HC-55260
Hydraulic Oil Filter.....	H-6902	Hydraulic Oil Filter.....	H-6902	N7-685I (COMBINES)	
HD-11G (TRACTORS) 11000 - ALLIS CHALMERS		HD-7G SERIES B (TRACTORS) ALLISCHA 3500		Hydraulic Oil Filter.....	HC-55260
Hydraulic Oil Filter.....	H-6902	Hydraulic Oil Filter Transmission...	H-65030	R42 (AGRICULTURE)	
HD-12G (TRACTORS) ALLISCHA 11000		HD-9 (TRACTORS) DETROIT		Hydraulic Oil Filter.....	H-7936
Hydraulic Oil Filter Transmission...	H-65030	Hydraulic Oil Filter.....	H-6902	Hydraulic Oil Filter.....	HC-55260
HD-15 (CONSTRUCTION EQUIPMENTS) 6-71 - DETROIT		HD-9G (TRACTORS) DETROIT		R5 (COMBINES)	
Hydraulic Oil Filter.....	H-6902	Hydraulic Oil Filter.....	H-6902	Hydraulic Oil Filter.....	HC-55260



ENGINE APPLICATION

MODEL/APPLICATION	SAKURA NO	MODEL/APPLICATION	SAKURA NO	MODEL/APPLICATION	SAKURA NO
ALLIS CHALMERS		ALLIS CHALMERS		ALLIS CHALMERS	
R52 (AGRICULTURE)		T-460 (CONSTRUCTION EQUIPMENTS) 21000		TL-16D (LOADERS) ALLISCHA 6000	
Hydraulic Oil Filter.....	H-7936	Hydraulic Oil Filter.....	H-5517	Hydraulic Oil Filter Transmission...	H-65030
Hydraulic Oil Filter.....	HC-55260				
R 6 (COMBINES - HARVESTERS)		T-460 (CONSTRUCTION EQUIPMENTS) 21000 - ALLIS CHALMERS		TL-16D (LOADERS) ALLISCHA 7000	
Hydraulic Oil Filter.....	HC-7932	Hydraulic Oil Filter.....	H-5517	Hydraulic Oil Filter Transmission...	H-65030
Hydraulic Oil Filter.....	HC-55260				
R60 (COMBINES)		T-460 (CONSTRUCTION EQUIPMENTS) 25000		TL-14D (LOADERS) ALLISCHA 6000	
Hydraulic Oil Filter.....	HC-55260	Hydraulic Oil Filter.....	H-5517	Hydraulic Oil Filter Transmission...	H-65030
R62 (COMBINES)		T-460 (CONSTRUCTION EQUIPMENTS) 25000 - ALLIS CHALMERS		TL-16 (LOADERS) ALLISCHA G-3400	
Hydraulic Oil Filter.....	HC-55260	Hydraulic Oil Filter.....	H-5517	Hydraulic Oil Filter Transmission...	H-65030
R7 (COMBINES)		T-460 (SCRAPERS) ALLISCHA 21000		TL20D (LOADERS) ALLISCHA 10000	
Hydraulic Oil Filter.....	HC-55260	Hydraulic Oil Filter Transmission...	H-65030	Hydraulic Oil Filter Transmission...	H-65030
		Hydraulic Oil Filter.....	H-7976		
R72 (COMBINES)		T-460 (SCRAPERS) ALLISCHA 25000		TL-545 (CONSTRUCTION & MINING) ALLISCHA 2900	
Hydraulic Oil Filter.....	HC-55260	Hydraulic Oil Filter Transmission...	H-65030	Hydraulic Oil Filter.....	H-5503
		Hydraulic Oil Filter.....	H-7976		
T-16D (LOADERS) ALLISCHA 3500		T-560 (CONSTRUCTION EQUIPMENTS) 21000		TL-545 (CONSTRUCTION & MINING) ALLISCHA 2900 MK II	
Hydraulic Oil Filter Transmission...	H-65030	Hydraulic Oil Filter.....	H-5517	Hydraulic Oil Filter.....	H-5503
T-260 (CONSTRUCTION EQUIPMENTS) 21000		T-560 (CONSTRUCTION EQUIPMENTS) 21000 - ALLIS CHALMERS		TL-545 (LOADERS) ALLISCHA 2900	
Hydraulic Oil Filter.....	H-5517	Hydraulic Oil Filter.....	H-5517	Hydraulic Oil Filter.....	H-5503
T-260 (CONSTRUCTION EQUIPMENTS) 21000 - ALLIS CHALMERS		T-560 (CONSTRUCTION EQUIPMENTS) 25000		TL-545 (LOADERS) ALLISCHA 2900 MK II	
Hydraulic Oil Filter.....	H-5517	Hydraulic Oil Filter.....	H-5517	Hydraulic Oil Filter.....	H-5503
T-260 (SCRAPERS) ALLISCHA 21000		T-560 (CONSTRUCTION EQUIPMENTS) 25000 - ALLIS CHALMERS		TL-545 (TRACTORS) 2900	
Hydraulic Oil Filter.....	H-7976	Hydraulic Oil Filter.....	H-5517	Hydraulic Oil Filter.....	H-5503
T-260B (CONSTRUCTION EQUIPMENTS) 21000		TL-10 (LOADERS) ALLISCHA W-226		TL-545H (CONSTRUCTION & MINING) ALLISCHA 2900	
Hydraulic Oil Filter.....	H-5517	Hydraulic Oil Filter Transmission...	H-65030	Hydraulic Oil Filter.....	H-5503
T-260B (CONSTRUCTION EQUIPMENTS) 21000 - ALLIS CHALMERS		TL-10D (LOADERS) ALLISCHA D-262		TL-545H (TRACTORS) 2900	
Hydraulic Oil Filter.....	H-5517	Hydraulic Oil Filter Transmission...	H-65030	Hydraulic Oil Filter.....	H-5503
T-260E Series A (CONSTRUCTION EQUIPMENTS) 21000		TL-11 (LOADERS) ALLISCHA W-226		TL-545 B (LOADERS)	
Hydraulic Oil Filter.....	H-5517	Hydraulic Oil Filter Transmission...	H-65030	Hydraulic Oil Filter.....	H-5503
T-260E Series A (CONSTRUCTION EQUIPMENTS) S/N: 8001		TL-12 (LOADERS) ALLISCHA G-226		TL-605B (CONSTRUCTION & MINING) ALLISCHA 2900 MK II	
Hydraulic Oil Filter.....	H-5517	Hydraulic Oil Filter Transmission...	H-65030	Hydraulic Oil Filter.....	H-5503
T-261B (CONSTRUCTION EQUIPMENTS) 21000		TL-12 (LOADERS) ALLISCHA G-262		TL-645B (CONSTRUCTION & MINING) ALLISCHA 3500 MK II	
Hydraulic Oil Filter.....	H-5517	Hydraulic Oil Filter Transmission...	H-65030	Hydraulic Oil Filter.....	H-5503
T-261B (CONSTRUCTION EQUIPMENTS) 21000 - ALLIS CHALMERS		TL-12A (LOADERS) ALLISCHA D-262		TL-645 (LOADERS)	
Hydraulic Oil Filter.....	H-5517	Hydraulic Oil Filter Transmission...	H-65030		



ENGINE APPLICATION

MODEL/APPLICATION	SAKURA NO	MODEL/APPLICATION	SAKURA NO	MODEL/APPLICATION	SAKURA NO
ALLIS CHALMERS		ALLISON		ALLISON	
TL-645 (LOADERS)		Hydraulic Oil Filter Transmission..	H-8537-S	WORLD TRANSMISSION (TRANSMISSIONS)	
Hydraulic Oil Filter.....	H-5503	Hydraulic Oil Filter Transmission..	H-8538-S	Hydraulic Oil Filter Transmission...	H-8537-S
Hydraulic Oil Filter Transmission...	H-65030	Hydraulic Oil Filter Transmission....	H-8538	Hydraulic Oil Filter Transmission....	H-8538
TL-745B (CONSTRUCTION & MINING)		4000 Series (TRANSMISSIONS)		Hydraulic Oil Filter Transmission...	H-8538-S
ALLISCHA A-CH 11000 MK II		Hydraulic Oil Filter Transmission....	H-8538	Hydraulic Oil Filter Transmission....	H-8538
Hydraulic Oil Filter.....	H-5503	Hydraulic Oil Filter Transmission..	H-8538-S	Hydraulic Oil Filter Transmission...	H-8538-S
Hydraulic Oil Filter.....	H-5503	Hydraulic Oil Filter Transmission..	H-8537-S		
TL-745C (CONSTRUCTION & MINING)		700 SERIES HT-700 (TRANSMISSIONS)		AMMANN	
ALLISCHA A-CH 11000 MK II		Hydraulic Oil Filter Transmission...	H-53010	AV12 (LOADERS)	
Hydraulic Oil Filter.....	H-5503			Hydraulic Oil Filter.....	H-4904
TL-745HB (CONSTRUCTION & MINING)		CLBT-750 (TRANSMISSIONS)		AV26 (LOADERS)	
ALLISCHA A-CH 11000 MK II		Hydraulic Oil Filter Transmission...	H-53010	Hydraulic Oil Filter.....	H-4904
Hydraulic Oil Filter.....	H-5503			AV26E (COMPACTORS)	
TL-745 (LOADERS)		CR33211 (TRANSMISSIONS)		YANMAR 3TNV88-XAMM , 2005-UP	
Hydraulic Oil Filter.....	H-5503	Hydraulic Oil Filter Transmission...	H-53010	Hydraulic Oil Filter.....	H-4904
TL-945 (CONSTRUCTION & MINING)		HT700 (TRANSMISSIONS)		DUOMAT DR 66 (LOADERS)	
ALLISCHA 25000 MK II		Hydraulic Oil Filter.....	HC-6501	Hydraulic Oil Filter.....	HC-6801
Hydraulic Oil Filter.....	H-5503	Hydraulic Oil Filter Transmission...	H-65030	HL6600 SERIES III (COMPACTORS)	
Hydraulic Oil Filter.....	H-5503	Hydraulic Oil Filter Transmission...	H-53010	Hydraulic Oil Filter.....	HC-5511
TL-945 (TRACTORS)		HT740 (TRANSMISSIONS)		HL6600 SERIES IV (COMPACTORS)	
25000 MKII		Hydraulic Oil Filter.....	HC-6501	Hydraulic Oil Filter.....	HC-5511
Hydraulic Oil Filter.....	H-5503	HT750 (TRANSMISSIONS)		APACHE	
TL-945B (CONSTRUCTION & MINING)		Hydraulic Oil Filter.....	HC-6501	1280 (SPRAYERS)	
ALLISCHA 25000 MK II		MODELS (TRANSMISSIONS)		Hydraulic Oil Filter.....	HC-62010
Hydraulic Oil Filter.....	H-5503	Hydraulic Oil Filter.....	HC-69031	ARO	
TL-945B (TRACTORS)		MT-3060P (TRANSMISSIONS)		240-244 (PASSENGER CARS)	
25000 MKII		Hydraulic Oil Filter Transmission..	H-8537-S	2.3 D PEUGEOT , 2300	
Hydraulic Oil Filter.....	H-5503	Hydraulic Oil Filter Transmission..	H-8537-S	Hydraulic Oil Filter Transmission...	HC-45150
TR260 (CONSTRUCTION EQUIPMENTS)		MT643 (TRANSMISSIONS)		ASTRA	
16000		Hydraulic Oil Filter Transmission...	H-53010	BM501 (DUMP TRUCKS)	
Hydraulic Oil Filter.....	H-5517	Torqmatic (TRANSMISSIONS)		IVECO	
TR260 (SCRAPERS)		Hydraulic Oil Filter Transmission...	H-53010	Hydraulic Oil Filter Transmission...	H-53010
ALLISCHA 16000		Torqmatic Series (TRANSMISSIONS)		ATHEY	
Hydraulic Oil Filter.....	H-7976	Hydraulic Oil Filter Transmission..	H-8538-S	AB-6903H (BLADE)	
TR260 (SCRAPERS)		Hydraulic Oil Filter Transmission..	H-8538-S	Hydraulic Oil Filter.....	H-79411
ALLISCHA 19000		TT (TRANSMISSIONS)		Hydraulic Oil Filter.....	H-51170
Hydraulic Oil Filter.....	H-7976	Hydraulic Oil Filter Transmission...	H-65030	ATILA	
TS-260 (CONSTRUCTION EQUIPMENTS)		Hydraulic Oil Filter Transmission...	H-53010	1202 (GRADERS)	
16000		V730 (TRANSMISSIONS)		DEUTZ F3L912	
Hydraulic Oil Filter.....	H-5517	Hydraulic Oil Filter.....	HC-6501	Hydraulic Oil Filter.....	H-71140
TS-260 (SCRAPERS)		Hydraulic Oil Filter Transmission...	H-53010	1252 (GRADERS)	
S/N: 5307-7999		ALLISON		DEUTZ F3L912	
Hydraulic Oil Filter.....	H-7976	Hydraulic Oil Filter.....	HC-6501	Hydraulic Oil Filter.....	H-62040
TS-260E (SCRAPERS)		Hydraulic Oil Filter Transmission...	H-53010	1302C (GRADERS)	
S/N: 8000-UP		3000 SERIES (TRANSMISSIONS)		DEUTZ F4L912	
Hydraulic Oil Filter.....	H-7976				



ENGINE APPLICATION

MODEL/APPLICATION	SAKURA NO	MODEL/APPLICATION	SAKURA NO	MODEL/APPLICATION	SAKURA NO
ATILA		ATLAS COPCO		ATLAS COPCO	
1302C (GRADERS) DEUTZ F4L912		GA 1207 (AIR COMPRESSORS)		GA 45 (AIR COMPRESSORS) 1995-UP	
Hydraulic Oil Filter.....	H-62040	Hydraulic Oil Filter.....	HC-6217	Hydraulic Oil Filter.....	HC-6217
1302 (GRADERS) DEUTZ F4L912		GA 132 TP (AIR COMPRESSORS)		GA 45 (AIR COMPRESSORS) 1994-UP	
Hydraulic Oil Filter.....	H-71140	Hydraulic Oil Filter.....	HC-6217	Hydraulic Oil Filter.....	HC-6217
1302D (GRADERS) DEUTZ F5L912		GA 18P (AIR COMPRESSORS) S/N: 243410-UP , 1999-UP		GA 55 (AIR COMPRESSORS) T0-1994	
Hydraulic Oil Filter.....	H-62040	Hydraulic Oil Filter.....	HC-6217	Hydraulic Oil Filter.....	HC-6217
1602 (GRADERS) DEUTZ F4L912		GA11FF (AIR COMPRESSORS) 2008-UP		GA 55 (AIR COMPRESSORS) 2000-UP	
Hydraulic Oil Filter.....	H-71140	Hydraulic Oil Filter.....	HC-6217	Hydraulic Oil Filter.....	HC-6217
1702 (GRADERS) DEUTZ F6L912		GA 207 (AIR COMPRESSORS)		GA 55 (AIR COMPRESSORS) 1996-UP	
Hydraulic Oil Filter.....	H-71140	Hydraulic Oil Filter.....	HC-6217	Hydraulic Oil Filter.....	HC-6217
1902 (GRADERS) DEUTZ F6L912		GA 230 (AIR COMPRESSORS)		GA 55 (AIR COMPRESSORS) 1995-UP	
Hydraulic Oil Filter.....	H-71140	Hydraulic Oil Filter.....	HC-6217	Hydraulic Oil Filter.....	HC-6217
2002 (GRADERS) DEUTZ F6L413		GA 237 (AIR COMPRESSORS)		GA 5 (AIR COMPRESSORS) 1998-UP	
Hydraulic Oil Filter.....	H-71140	Hydraulic Oil Filter.....	HC-6217	Hydraulic Oil Filter.....	HC-6217
ATLAS COPCO		ATLAS COPCO		ATLAS COPCO	
130C ROTAMEC (CONSTRUCTION & MINING)		GA 30 (AIR COMPRESSORS) T0-1993		GA 607 (AIR COMPRESSORS)	
Hydraulic Oil Filter.....	HC-7924	Hydraulic Oil Filter.....	HC-6217	Hydraulic Oil Filter.....	HC-6217
GA 11 (AIR COMPRESSORS) T0-1992		GA 30 (AIR COMPRESSORS) 2008-UP		GA 75 (AIR COMPRESSORS) 2000-UP	
Hydraulic Oil Filter.....	HC-6217	Hydraulic Oil Filter.....	HC-6217	Hydraulic Oil Filter.....	HC-6217
GA 11 (AIR COMPRESSORS) 2000-UP		GA 30 (AIR COMPRESSORS) S/N: 360 000-UP , 1998-UP		GA 75 (AIR COMPRESSORS) 1996-UP	
Hydraulic Oil Filter.....	HC-6217	Hydraulic Oil Filter.....	HC-6217	Hydraulic Oil Filter.....	HC-6217
GA 11 (AIR COMPRESSORS) 1995-UP		GA 30 (AIR COMPRESSORS) 1994-UP		GA 75 (AIR COMPRESSORS) 1995-UP	
Hydraulic Oil Filter.....	HC-6217	Hydraulic Oil Filter.....	HC-6217	Hydraulic Oil Filter.....	HC-6217
GA 11 (AIR COMPRESSORS) 1993-UP		GA 37 (AIR COMPRESSORS) S/N: 360 000-UP , 1998-UP		GA 75 TP (AIR COMPRESSORS) ATLAS CPC 1LA6-228-2AB	
Hydraulic Oil Filter.....	HC-6217	Hydraulic Oil Filter.....	HC-6217	Hydraulic Oil Filter.....	HC-6217
GA 10 (AIR COMPRESSORS) 1998-UP		GA 300 (AIR COMPRESSORS)		GA 807 (AIR COMPRESSORS)	
Hydraulic Oil Filter.....	HC-6217	Hydraulic Oil Filter.....	HC-6217	Hydraulic Oil Filter.....	HC-6217
GA 100 (AIR COMPRESSORS)		GA 30P (AIR COMPRESSORS) ATLAS CPC 1LA6-207-4AA		GA 90 (AIR COMPRESSORS) 1999-UP	
Hydraulic Oil Filter.....	HC-6217	Hydraulic Oil Filter.....	HC-6217	Hydraulic Oil Filter.....	HC-6217
GA 110 TP (AIR COMPRESSORS)		GA 345 (AIR COMPRESSORS)		GA 90 (AIR COMPRESSORS)	
Hydraulic Oil Filter.....	HC-6217	Hydraulic Oil Filter.....	HC-6217	Hydraulic Oil Filter.....	HC-6217
GA 111 (AIR COMPRESSORS)		GA 355 (AIR COMPRESSORS)		GA 90 TP (AIR COMPRESSORS)	
Hydraulic Oil Filter.....	HC-6217	Hydraulic Oil Filter.....	HC-6217	Hydraulic Oil Filter.....	HC-6217
		GA 45 (AIR COMPRESSORS) T0-1993		GAH 115 (AIR COMPRESSORS)	
		Hydraulic Oil Filter.....	HC-6217	Hydraulic Oil Filter.....	HC-6217



ENGINE APPLICATION

MODEL/APPLICATION	SAKURA NO	MODEL/APPLICATION	SAKURA NO	MODEL/APPLICATION	SAKURA NO
ATLAS COPCO		ATLAS COPCO		ATLAS COPCO	
GX 5 (AIR COMPRESSORS)		ROC L8 (DRILLING) CAT 3196		XA 35 (AIR COMPRESSORS)	
Hydraulic Oil Filter.....	HC-6217	Hydraulic Oil Filter.....	HC-7924	Hydraulic Oil Filter.....	HC-6217
H127 BOOMER (CONSTRUCTION EQUIPMENTS)		Hydraulic Oil Filter.....	H-6701	XA 350 (AIR COMPRESSORS) DEUTZ F8L413F	
Hydraulic Oil Filter.....	H-6701	ROC F6 (DRILLING) MERCEDES		Hydraulic Oil Filter.....	HC-6217
H128 BOOMER (CONSTRUCTION EQUIPMENTS)		Hydraulic Oil Filter.....	H-6701	XA 350 D (AIR COMPRESSORS) DEUTZ F8L413	
Hydraulic Oil Filter.....	H-6701	Hydraulic Oil Filter.....	HC-7924	Hydraulic Oil Filter.....	HC-6217
HRHS 350 D (AIR COMPRESSORS)		Hydraulic Oil Filter.....	HC-6217	XA 350DD (AIR COMPRESSORS) DEUTZ F8L413F , TO-1980	
Hydraulic Oil Filter.....	HC-6217	ROC F7 (DRILLING) MERCEDES		Hydraulic Oil Filter.....	HC-6217
MODELS (AIR COMPRESSORS)		Hydraulic Oil Filter.....	HC-6217	XA 350DD (AIR COMPRESSORS) DEUTZ F8L413F , 1981-UP	
Hydraulic Oil Filter.....	H-51170	ROC F9 (DRILLING) 2006-UP		Hydraulic Oil Filter.....	HC-6217
MT5010 (CONSTRUCTION & MINING) CUMMINS QSK19		Hydraulic Oil Filter.....	H-6701	XA 36 (AIR COMPRESSORS) YANMAR 3TNE68	
Hydraulic Oil Filter.....	HC-5507	Hydraulic Oil Filter.....	HC-7924	Hydraulic Oil Filter.....	HC-6217
Hydraulic Oil Filter.....	HC-5506	ST71DD (AIR COMPRESSORS) DEUTZ F6L912		XA 40 (AIR COMPRESSORS) DEUTZ F2L511D	
MT5010 (CONSTRUCTION & MINING) DETROITD SERIES 2000 (V8)		Hydraulic Oil Filter.....	HC-6217	Hydraulic Oil Filter.....	HC-6217
Hydraulic Oil Filter.....	HC-5506	VT3DD (AIR COMPRESSORS) DEUTZ F3L912		XA 40 DD (AIR COMPRESSORS) DEUTZ	
PR700DD (AIR COMPRESSORS) DEUTZ F10L413		Hydraulic Oil Filter.....	HC-1822	Hydraulic Oil Filter.....	HC-6217
Hydraulic Oil Filter.....	HC-6217	VT4DD (AIR COMPRESSORS) DEUTZ F4L912		XA 50 D (AIR COMPRESSORS)	
ROC 302 (DRILLING) 1977-UP		Hydraulic Oil Filter.....	HC-1822	Hydraulic Oil Filter.....	HC-6217
Hydraulic Oil Filter.....	H-7915	XA 120 (AIR COMPRESSORS) DEUTZ F4L912		XA 55 (AIR COMPRESSORS)	
ROC 311 (DRILLING)		Hydraulic Oil Filter.....	HC-6217	Hydraulic Oil Filter.....	HC-6217
Hydraulic Oil Filter.....	H-7915	XA 125 D (AIR COMPRESSORS)		XA 556 (AIR COMPRESSORS) DEUTZ S2M1011	
ROC 410HC (DRILLING) DEUTZ F4L912		Hydraulic Oil Filter.....	HC-6217	Hydraulic Oil Filter.....	HC-6217
Hydraulic Oil Filter.....	HC-6217	XA 160 (AIR COMPRESSORS) DEUTZ F6L912		XA 65 (AIR COMPRESSORS)	
ROC 601 (DRILLING) TO-1977		Hydraulic Oil Filter.....	HC-6217	Hydraulic Oil Filter.....	HC-6217
Hydraulic Oil Filter.....	H-7915	XA 175D (AIR COMPRESSORS) DEUTZ F6L913		XA 75 (AIR COMPRESSORS) DEUTZ F3L912	
ROC 701 (DRILLING)		Hydraulic Oil Filter.....	HC-6217	Hydraulic Oil Filter.....	HC-6217
Hydraulic Oil Filter.....	H-7915	XA 125 (AIR COMPRESSORS)		XA 80 (AIR COMPRESSORS) DEUTZ F6L912	
ROC 712 H01 (DRILLING) DEUTZ		Hydraulic Oil Filter.....	HC-6217	Hydraulic Oil Filter.....	HC-6217
Hydraulic Oil Filter.....	H-7915	XA 210DD (AIR COMPRESSORS) DEUTZ BF6L913 , TO-1980		XA 85 D (AIR COMPRESSORS) DEUTZ F3L912	
ROC D7 (DRILLING)		Hydraulic Oil Filter.....	HC-6217	Hydraulic Oil Filter.....	HC-6217
Hydraulic Oil Filter.....	HC-6217	XA 210DD (AIR COMPRESSORS) DEUTZ BF6L913 , 1980-UP		XA 97 (AIR COMPRESSORS)	
Hydraulic Oil Filter.....	H-6701	Hydraulic Oil Filter.....	HC-6217	Hydraulic Oil Filter.....	HC-6217
ROC D7-11 (DRILLING) CAT 3116 (S/N: 2MR02651-UP)		XA 230 (AIR COMPRESSORS) DEUTZ BF6L913		XAHS 285 (AIR COMPRESSORS)	
Hydraulic Oil Filter.....	HC-6217	Hydraulic Oil Filter.....	HC-6217	Hydraulic Oil Filter.....	HC-7924
Hydraulic Oil Filter.....	H-6701				



ENGINE APPLICATION

MODEL/APPLICATION	SAKURA NO	MODEL/APPLICATION	SAKURA NO	MODEL/APPLICATION	SAKURA NO
ATLAS COPCO		ATLAS COPCO		ATLAS COPCO	
XAHS 365 (AIR COMPRESSORS)		XAS 85DD- RR (AIR COMPRESSORS) DEUTZ F3L912		Hydraulic Oil Filter.....	HC-6217
Hydraulic Oil Filter.....	HC-7924	Hydraulic Oil Filter.....	HC-6217	XAS 36 (AIR COMPRESSORS) YANMAR 3TNE68-AC	
XAHS 365MD (AIR COMPRESSORS)		XAS940LD (AIR COMPRESSORS) CAT 3306 DITAJ WAC (S/N: ATP390018-UP)		Hydraulic Oil Filter.....	HC-6217
Hydraulic Oil Filter.....	HC-7924	Hydraulic Oil Filter.....	HC-6217	XAS 36 (AIR COMPRESSORS) YANMAR 3TNE68E	
XAS 175 (AIR COMPRESSORS) DEUTZ F6L913		XAS 96 (AIR COMPRESSORS) DEUTZ		Hydraulic Oil Filter.....	HC-6217
Hydraulic Oil Filter.....	HC-6217	Hydraulic Oil Filter.....	HC-6217	XAS 3747 (AIR COMPRESSORS) KUBOTA D1105E , 2007-UP	
XAS 186 (AIR COMPRESSORS) DEUTZ BF4M2012C		XAS 96 (AIR COMPRESSORS) DEUTZ BF3M1011F		Hydraulic Oil Filter.....	HC-6217
Hydraulic Oil Filter.....	HC-6217	Hydraulic Oil Filter.....	HC-6217	XAS 40 D (AIR COMPRESSORS)	
XAS 405 (AIR COMPRESSORS)		XAS 96D (AIR COMPRESSORS) DEUTZ F3M1011F , 1999-UP		Hydraulic Oil Filter.....	HC-6217
Hydraulic Oil Filter.....	HC-6217	Hydraulic Oil Filter.....	HC-6217	XAS 430 (AIR COMPRESSORS)	
XAS 46 (AIR COMPRESSORS) DEUTZ F2M1011		XAS 96 DD (AIR COMPRESSORS) DEUTZ F3M1011		Hydraulic Oil Filter.....	HC-6217
Hydraulic Oil Filter.....	HC-6217	Hydraulic Oil Filter.....	HC-6217	XAS 45 (AIR COMPRESSORS) DEUTZ F2L1011	
XAS 47 (AIR COMPRESSORS) DEUTZ F2M2011		XAS 96 DD (AIR COMPRESSORS) DEUTZ F4M		Hydraulic Oil Filter.....	HC-6217
Hydraulic Oil Filter.....	HC-6217	Hydraulic Oil Filter.....	HC-6217	XAS 495 MD (AIR COMPRESSORS) MERCEDES OM441LA	
XAS 55 (AIR COMPRESSORS) DEUTZ F3L1011		XAS 125 (AIR COMPRESSORS) DEUTZ F4L913		Hydraulic Oil Filter.....	HC-6217
Hydraulic Oil Filter.....	HC-6217	Hydraulic Oil Filter.....	HC-6217	XAS 60E (AIR COMPRESSORS) ATLAS CPC 1RA6	
XAS 56 (AIR COMPRESSORS) DEUTZ F2M1011		Hydraulic Oil Filter.....	HC-7924	Hydraulic Oil Filter.....	HC-6217
Hydraulic Oil Filter.....	HC-6217	XAS 125 D (AIR COMPRESSORS) S/N: 209142-UP		XAS 65 (AIR COMPRESSORS) DEUTZ F3L1011	
XAS 60 (AIR COMPRESSORS) DEUTZ F2L912		Hydraulic Oil Filter.....	HC-6217	Hydraulic Oil Filter.....	HC-6217
Hydraulic Oil Filter.....	HC-6217	XAS 137DD (AIR COMPRESSORS) DEUTZ BF4M2011		XAS 65 E (AIR COMPRESSORS) ATLAS CPC 1RA6	
XAS 60DD (AIR COMPRESSORS) DEUTZ F2L511D		Hydraulic Oil Filter.....	HC-6217	Hydraulic Oil Filter.....	HC-6217
Hydraulic Oil Filter.....	HC-6217	XAS 146 DD (AIR COMPRESSORS)		XAS 65D (AIR COMPRESSORS) DEUTZ F3L1011F	
XAS 66 (AIR COMPRESSORS) DEUTZ F3L1011		Hydraulic Oil Filter.....	HC-6217	Hydraulic Oil Filter.....	HC-6217
Hydraulic Oil Filter.....	HC-6217	XAS 26 (AIR COMPRESSORS)		XAS 75 (AIR COMPRESSORS) DEUTZ F3L1011	
XAS 75 D (AIR COMPRESSORS)		Hydraulic Oil Filter.....	HC-6217	Hydraulic Oil Filter.....	HC-6217
Hydraulic Oil Filter.....	HC-6217	XAS 30 DD (AIR COMPRESSORS) ATLAS CPC F1L511D		XAS 77 (AIR COMPRESSORS) DEUTZ F3M2011	
XAS 76 (AIR COMPRESSORS) DEUTZ F3M1011		Hydraulic Oil Filter.....	HC-6217	Hydraulic Oil Filter.....	HC-6217
Hydraulic Oil Filter.....	HC-6217	XAS 32 (AIR COMPRESSORS) DEUTZ BF4M1008		XAS 85 (AIR COMPRESSORS) DEUTZ F3L912	
XAS 80 (AIR COMPRESSORS) DEUTZ F3L912		Hydraulic Oil Filter.....	HC-6217	Hydraulic Oil Filter.....	HC-6217
Hydraulic Oil Filter.....	HC-6217	XAS 32 (AIR COMPRESSORS) YANMAR 3TNE68-AC		XAS 86 (AIR COMPRESSORS) DEUTZ BF3M1011F	
XAS 80DD (AIR COMPRESSORS) DEUTZ F3L912		Hydraulic Oil Filter.....	HC-6217	Hydraulic Oil Filter.....	HC-6217
Hydraulic Oil Filter.....	HC-6217	XAS 35 (AIR COMPRESSORS) DEUTZ F2L1011		XAS 90 (AIR COMPRESSORS) DEUTZ F4L1011	
XAS 85DD (AIR COMPRESSORS)		Hydraulic Oil Filter.....	HC-6217	Hydraulic Oil Filter.....	HC-6217
Hydraulic Oil Filter.....	HC-6217	XAS 35 DD (AIR COMPRESSORS) DEUTZ F3L1011		XAS 97 (AIR COMPRESSORS) DEUTZ F3M2011	



ENGINE APPLICATION

MODEL/APPLICATION	SAKURA NO	MODEL/APPLICATION	SAKURA NO	MODEL/APPLICATION	SAKURA NO
ATLAS COPCO		ATLAS COPCO		ATLAS WEYHAUSEN	
XAS 97 (AIR COMPRESSORS) DEUTZ F3M2011 Hydraulic Oil Filter.....	HC-6217	XRV5 450 D (AIR COMPRESSORS) Hydraulic Oil Filter.....	HC-6217	AR51 (LOADERS) DEUTZ F2L511 , 1973-UP Hydraulic Oil Filter.....	HC-6217
XASS 125 (AIR COMPRESSORS) Hydraulic Oil Filter.....	HC-6217	ATLAS		AR52E2 (LOADERS) Hydraulic Oil Filter.....	HC-62020
XASS 35 (AIR COMPRESSORS) Hydraulic Oil Filter.....	HC-6217	AR95 (LOADERS) DEUTZ BF4L2012 , 2001-UP Hydraulic Oil Filter.....	HC-1822	Hydraulic Oil Filter.....	H-51050
XASS 55 (AIR COMPRESSORS) DEUTZ F3L1011 Hydraulic Oil Filter.....	HC-6217	ATLAS WEYHAUSEN		AR62 E (LOADERS) Hydraulic Oil Filter.....	HC-62020
XASS 65 (AIR COMPRESSORS) Hydraulic Oil Filter.....	HC-6217	45 (LOADERS) Hydraulic Oil Filter.....	H-51050	Hydraulic Oil Filter.....	H-51050
XAVS136DD (AIR COMPRESSORS) Hydraulic Oil Filter.....	HC-6217	85 (LOADERS) Hydraulic Oil Filter.....	H-51050	AR65 (LOADERS) DEUTZ F4L2011 , 2001-UP Hydraulic Oil Filter.....	H-51050
Hydraulic Oil Filter.....	HC-7924	Hydraulic Oil Filter.....	HC-62020	Hydraulic Oil Filter.....	HC-62020
XR 210 (AIR COMPRESSORS) Hydraulic Oil Filter.....	HC-6217	AB1200 (EXCAVATORS) Hydraulic Oil Filter.....	H-71140	AR65 (LOADERS) DEUTZ F4L1011 , 1998-2001 Hydraulic Oil Filter.....	HC-62020
XR 350 (AIR COMPRESSORS) Hydraulic Oil Filter.....	HC-6217	AB1202 (EXCAVATORS) DEUTZ F3/4L912 , 1970-UP Hydraulic Oil Filter.....	H-71140	AR62E2 (LOADERS) Hydraulic Oil Filter.....	H-51050
XRHS 385MD (AIR COMPRESSORS) 2000-UP Hydraulic Oil Filter.....	HC-7924	AB1252 (EXCAVATORS) DEUTZ F3L912 Hydraulic Oil Filter.....	H-71140	Hydraulic Oil Filter.....	H-51050
XRHS 396 (AIR COMPRESSORS) MERCEDES OM926LA-6L , 2002-UP Hydraulic Oil Filter.....	HC-7924	AB1302 (EXCAVATORS) DEUTZ F3/4L912 , 1972-UP Hydraulic Oil Filter.....	H-71140	Hydraulic Oil Filter.....	HC-62020
XRS 210 (AIR COMPRESSORS) Hydraulic Oil Filter.....	HC-6217	AB1302C (EXCAVATORS) DEUTZ , 1974-UP Hydraulic Oil Filter.....	H-62040	AR70.3 (LOADERS) Hydraulic Oil Filter.....	H-51050
XRS 210D (AIR COMPRESSORS) DEUTZ F6L413F Hydraulic Oil Filter.....	HC-6217	AB1302D (EXCAVATORS) DEUTZ F4L912 , 1976-UP Hydraulic Oil Filter.....	H-62040	Hydraulic Oil Filter.....	HC-62020
Hydraulic Oil Filter.....	HC-7924	AB1500 (EXCAVATORS) Hydraulic Oil Filter.....	H-71140	AR80 (LOADERS) Hydraulic Oil Filter.....	HC-62020
XRS 350 (AIR COMPRESSORS) Hydraulic Oil Filter.....	HC-6217	AB1602 (EXCAVATORS) DEUTZ , 1970-UP Hydraulic Oil Filter.....	H-71140	Hydraulic Oil Filter.....	H-51050
XRS 350D (AIR COMPRESSORS) DEUTZ F10/12L413F Hydraulic Oil Filter.....	HC-6217	AB1702 (EXCAVATORS) DEUTZ , 1970-UP Hydraulic Oil Filter.....	H-71140	AR82E2 (LOADERS) Hydraulic Oil Filter.....	H-51050
Hydraulic Oil Filter.....	HC-7924	AB1902 (EXCAVATORS) DEUTZ F6L912 , 1970-UP Hydraulic Oil Filter.....	H-71140	Hydraulic Oil Filter.....	HC-62020
XRV5 455 MD (AIR COMPRESSORS) DAIMLERB OM442LA Hydraulic Oil Filter.....	HC-6217	AB2002 (EXCAVATORS) 1970-UP Hydraulic Oil Filter.....	H-71140	AR86E (LOADERS) Hydraulic Oil Filter.....	HC-62020
Hydraulic Oil Filter.....	HC-7924	AR46E2 (LOADERS) Hydraulic Oil Filter.....	H-51050	Hydraulic Oil Filter.....	H-51050
XRV5 450 (AIR COMPRESSORS) Hydraulic Oil Filter.....	HC-6217			(LOADERS) ATLASWHN AR61A Hydraulic Oil Filter.....	HC-6217
				Hydraulic Oil Filter.....	HC-6217
				(LOADERS) ATLASWHN AR61B Hydraulic Oil Filter.....	HC-6217
				AUSTIN WESTERN	
				MODELS (CRANES) Hydraulic Oil Filter.....	H-5405



ENGINE APPLICATION

MODEL/APPLICATION	SAKURA NO	MODEL/APPLICATION	SAKURA NO	MODEL/APPLICATION	SAKURA NO
AUSTIN WESTERN		BELL		BOBCAT	
MODELS (CRANES)		Hydraulic Oil Filter.....	HC-7927	100 (EXCAVATORS)	
Hydraulic Oil Filter.....	H-7936	B25B (DUMP TRUCKS)		Hydraulic Oil Filter.....	H-5607
PACER 100 (GRADERS) GMC 4-53		Hydraulic Oil Filter Transmission... ..	HC-2701	1075 (LOADERS) JOEERE 4-276	
Hydraulic Oil Filter.....	HC-1903	B25D (DUMP TRUCKS) MERCEDES OM906LA , 2001-UP		Hydraulic Oil Filter.....	H-79411
PACER 100 (GRADERS) GMC 3-71		Hydraulic Oil Filter Transmission....	H-7102	1074 (LOADERS) PERKINS 4.236	
Hydraulic Oil Filter.....	HC-1903	B30C (DUMP TRUCKS) S/N: 6X6-UP		Hydraulic Oil Filter.....	H-79411
AVELING BARFORD		Hydraulic Oil Filter Transmission... ..	HC-2701	116 (EXCAVATORS)	
CENTAUR 50 (DUMP TRUCKS) DETROITD 16V-71		B30B (DUMP TRUCKS)		Hydraulic Oil Filter.....	H-5607
Hydraulic Oil Filter Transmission... ..	H-65030	Hydraulic Oil Filter Transmission... ..	HC-2701	1213 (LOADERS)	
AXECO		B40B (DUMP TRUCKS) MERCEDES		Hydraulic Oil Filter.....	HC-7927
V76 (AIR COMPRESSORS) DEUTZ F4L912		Hydraulic Oil Filter.....	HC-5503	130 (EXCAVATORS)	
Hydraulic Oil Filter.....	HC-1822	B40C-II (DUMP TRUCKS)		Hydraulic Oil Filter.....	H-5607
BANDIT INDUSTRIES		Hydraulic Oil Filter Transmission... ..	H-8537-S	1600 (LOADERS) KUBOTA 4 CYL	
90 (CHIPPERS) JOEERE 4045		SUPER T (FELLER BUNCHERS) DEUTZ		Hydraulic Oil Filter.....	HC-7927
Hydraulic Oil Filter.....	HC-19040	Hydraulic Oil Filter.....	HC-7927	1600 (LOADERS)	
MODEL 65 (CHIPPERS) DEUTZ F2L1011		Hydraulic Oil Filter.....	H-79411	Hydraulic Oil Filter.....	HC-7927
Hydraulic Oil Filter.....	HC-19040	T12 (CONSTRUCTION EQUIPMENTS)		2000 (LOADERS)	
BARBER GREENE		Hydraulic Oil Filter.....	H-79411	Hydraulic Oil Filter.....	HC-7927
BG-230 (PAVING EQUIPMENT) CAT 3054		Hydraulic Oil Filter Transmission... ..	HC-2701	Hydraulic Oil Filter.....	HC-7927
Hydraulic Oil Filter.....	HC-5507	BIG BUD		220 (SHOVELS) S/N: 12000-UP	
Hydraulic Oil Filter.....	HC-76080	360 (TRACTORS) CUMMINS NTA-855		Hydraulic Oil Filter Full Flow.....	HC-7901
TA56 (EXCAVATORS) DETROITD 4-53		Hydraulic Oil Filter.....	H-7976	220 (SHOVELS) S/N: 15000-UP	
Hydraulic Oil Filter Transmission... ..	H-65030	400 (TRACTORS) DETROITD 8V-92T		Hydraulic Oil Filter Full Flow.....	HC-7901
Hydraulic Oil Filter.....	HC-19040	Hydraulic Oil Filter.....	H-7976	225 (EXCAVATORS)	
TA65 (EXCAVATORS) DETROITD 6-71		450 (TRACTORS) CUMMINS KTA-1150		Hydraulic Oil Filter.....	H-2719
Hydraulic Oil Filter Transmission... ..	H-65030	Hydraulic Oil Filter.....	H-7976	Hydraulic Oil Filter Full Flow.....	HC-7901
BELL		BITELLI		231 (EXCAVATORS)	
120 (FORKLIFTS) DEUTZ F4L912		747 (TRACTORS) DETROITD 16V-92T		Hydraulic Oil Filter Full Flow.....	HC-7901
Hydraulic Oil Filter.....	HC-7927	Hydraulic Oil Filter.....	H-7976	Hydraulic Oil Filter.....	H-2719
220C (FORKLIFTS) CUMMINS		BLOUNT		2400 (LOADERS)	
Hydraulic Oil Filter.....	HC-7927	BORA C80 (PAVING EQUIPMENT) DEUTZ F4L912		Hydraulic Oil Filter.....	HC-7927
220B (LOGGERS) DEUTZ BF4L913		Hydraulic Oil Filter.....	HC-1822	3022 (TRENCHERS)	
Hydraulic Oil Filter.....	HC-7927	611BI (AGRICULTURE) CUMMINS 6BTA5.9		Hydraulic Oil Filter.....	HC-7972
220B (LOGGERS) DEUTZ F4L912		Hydraulic Oil Filter.....	HC-5511	3023 (TRENCHERS)	
Hydraulic Oil Filter.....	HC-1822	Hydraulic Oil Filter.....	HC-5511	Hydraulic Oil Filter.....	HC-7972
220 A (FORKLIFTS) DEUTZ F4L912		BOBCAT			



ENGINE APPLICATION

MODEL/APPLICATION	SAKURA NO	MODEL/APPLICATION	SAKURA NO	MODEL/APPLICATION	SAKURA NO
BOBCAT		BOBCAT		BOBCAT	
310 (LOADERS)		400 (LOADERS)		553AF (SKIDDERS)	
Hydraulic Oil Filter.....	HC-1903	Hydraulic Oil Filter.....	H-79411	Hydraulic Oil Filter.....	HC-5507
319 (EXCAVATORS) KUBOTA D722-E2B-BC-5 , 2006-UP		430 (EXCAVATORS) KUBOTA V2203M , 2007-UP		553F (SKIDDERS) S/N: 5164-UP	
Hydraulic Oil Filter Full Flow.....	HC-7901	Hydraulic Oil Filter.....	HC-5507	Hydraulic Oil Filter.....	HC-5507
320 (SHOVELS) KUBOTA D750		Hydraulic Oil Filter.....	HC-5504	553AF/BF (SKIDDERS)	
Hydraulic Oil Filter Full Flow.....	HC-7901	430D (LOADERS)		Hydraulic Oil Filter.....	HC-5507
320D (LOADERS)		Hydraulic Oil Filter.....	HC-5507	56 (EXCAVATORS)	
Hydraulic Oil Filter Full Flow.....	HC-7901	435 (EXCAVATORS) KUBOTA V2203 , 2007-UP		Hydraulic Oil Filter.....	H-5607
320/322 (SHOVELS) KUBOTA D722		Hydraulic Oil Filter.....	HC-5507	5600 TOOLCAT (LOADERS) KUBOTA V2003 , 2003-UP	
Hydraulic Oil Filter Full Flow.....	HC-7901	Hydraulic Oil Filter.....	HC-5504	Hydraulic Oil Filter.....	HC-5504
325 (EXCAVATORS) KUBOTA (S/N: 11000-14899)		435D (SHOVELS)		600 (LOADERS) DEUTZ 410	
Hydraulic Oil Filter Full Flow.....	HC-7901	Hydraulic Oil Filter.....	HC-5507	Hydraulic Oil Filter.....	HC-1822
325 (EXCAVATORS) KUBOTA (S/N: 14900-UP)		442 (EXCAVATORS) S/N: TIER I-UP , 2002-UP		600 (LOADERS) DEUTZ 411	
Hydraulic Oil Filter Full Flow.....	HC-7901	Hydraulic Oil Filter.....	H-62080	Hydraulic Oil Filter.....	H-79411
325D (LOADERS) KUBOTA D1703 , 2000-UP		442 (EXCAVATORS)		600 (LOADERS) KOHLER K662	
Hydraulic Oil Filter.....	HC-5507	Hydraulic Oil Filter.....	H-62080	Hydraulic Oil Filter.....	H-51170
328 (EXCAVATORS)		444 (LOADERS) KOHLER		600 (LOADERS) WISCONSIN VH-4D	
Hydraulic Oil Filter.....	HC-5506	Hydraulic Oil Filter.....	H-79411	Hydraulic Oil Filter.....	H-79411
Hydraulic Oil Filter.....	HC-19040	444 (LOADERS) ONAN		600 (LOADERS) WISCONSIN VF-4D	
329 (EXCAVATORS) KUBOTA D1703M		Hydraulic Oil Filter.....	H-79411	Hydraulic Oil Filter.....	H-79411
Hydraulic Oil Filter.....	HC-5507	444 (LOADERS) S/N: TIER II-UP		611 (LOADERS) DEUTZ F2L411	
Hydraulic Oil Filter.....	HC-1903	Hydraulic Oil Filter.....	H-62080	Hydraulic Oil Filter.....	H-79411
331 (EXCAVATORS) KUBOTA V2203		500 (LOADERS) DEUTZ F2L410		641 (LOADERS) DEUTZ F2L511	
Hydraulic Oil Filter.....	HC-5507	Hydraulic Oil Filter.....	H-79411	Hydraulic Oil Filter.....	HC-7927
331D (LOADERS)		500 (LOADERS) KOHLER		641 (LOADERS)	
Hydraulic Oil Filter Full Flow.....	HC-7901	Hydraulic Oil Filter.....	H-79411	Hydraulic Oil Filter.....	HC-7927
332 (EXCAVATORS) KUBOTA (S/N: 13000-UP)		542B (LOADERS)		642 (LOADERS) FORD 4 CYL-98	
Hydraulic Oil Filter Full Flow.....	HC-7901	Hydraulic Oil Filter Full Flow.....	HC-7935	Hydraulic Oil Filter.....	HC-7927
337D (LOADERS)		543 (LOADERS) KUBOTA D950B		642 (LOADERS)	
Hydraulic Oil Filter.....	HC-5506	Hydraulic Oil Filter Full Flow.....	HC-7935	Hydraulic Oil Filter.....	HC-7927
337-341 (EXCAVATORS) S/N: 5154-UP		553 (LOADERS) KUBOTA D1105		642B (LOADERS)	
Hydraulic Oil Filter.....	HC-5506	Hydraulic Oil Filter.....	HC-5507	Hydraulic Oil Filter.....	HC-7927
371 (LOADERS) KOHLER K-321S		553 (SKIDDERS) S/N: 5130-UP		643 (LOADERS) KUBOTA D1402-B	
Hydraulic Oil Filter.....	HC-1903	Hydraulic Oil Filter Full Flow.....	HC-7935	Hydraulic Oil Filter.....	HC-7927



ENGINE APPLICATION

MODEL/APPLICATION	SAKURA NO	MODEL/APPLICATION	SAKURA NO	MODEL/APPLICATION	SAKURA NO
BOBCAT		BOBCAT		BOBCAT	
643 (LOADERS)		753 (LOADERS) KUBOTA V2203		Hydraulic Oil Filter.....	HC-5507
Hydraulic Oil Filter.....	HC-7927	Hydraulic Oil Filter.....	HC-5507	Hydraulic Oil Filter.....	HC-7972
645 (SKIDDERS)		753 (LOADERS)		843 (LOADERS) PERKINS (S/N: 13001-23999)	
Hydraulic Oil Filter.....	HC-7927	Hydraulic Oil Filter.....	HC-5507	Hydraulic Oil Filter.....	HC-7927
653 (CONSTRUCTION EQUIPMENTS)		753 BICS (LOADERS)		843I (LOADERS) S/N: 24001-UP	
Hydraulic Oil Filter.....	HC-5507	Hydraulic Oil Filter.....	HC-5507	Hydraulic Oil Filter.....	HC-7927
741 (LOADERS)		753G (LOADERS)		853 (LOADERS) ISUZU 44JB1 PK03	
Hydraulic Oil Filter.....	HC-7927	Hydraulic Oil Filter.....	HC-5507	Hydraulic Oil Filter.....	HC-5507
742 (LOADERS)		76 (EXCAVATORS)		853 (LOADERS)	
Hydraulic Oil Filter.....	HC-7927	Hydraulic Oil Filter.....	H-5607	Hydraulic Oil Filter.....	HC-5507
742B (LOADERS) MITSUBISHI		763 (LOADERS)		853 BICS (LOADERS)	
Hydraulic Oil Filter.....	HC-7927	Hydraulic Oil Filter.....	HC-5507	Hydraulic Oil Filter.....	HC-5507
742B (LOADERS)		763 H (LOADERS) KUBOTA V2203E		853H (LOADERS) ISUZU 4JB1	
Hydraulic Oil Filter.....	HC-7927	Hydraulic Oil Filter.....	HC-5507	Hydraulic Oil Filter.....	HC-5507
743 (LOADERS) KUBOTA V1702		763G (LOADERS)		863 (LOADERS)	
Hydraulic Oil Filter.....	HC-7927	Hydraulic Oil Filter.....	HC-55220	Hydraulic Oil Filter.....	HC-5507
Hydraulic Oil Filter Transmission...	TC-7918	Hydraulic Oil Filter.....	HC-5507	Hydraulic Oil Filter.....	HC-55220
743 (SKIDDERS)		773 (LOADERS)		863B (LOADERS)	
Hydraulic Oil Filter.....	HC-7927	Hydraulic Oil Filter.....	HC-5507	Hydraulic Oil Filter.....	HC-5507
743B (SKIDDERS)		773G (LOADERS)		Hydraulic Oil Filter.....	HC-55220
Hydraulic Oil Filter.....	HC-7927	Hydraulic Oil Filter.....	HC-55220	Hydraulic Oil Filter.....	HC-5507
743DS (SKIDDERS)		Hydraulic Oil Filter.....	HC-5507	863G (LOADERS)	
Hydraulic Oil Filter.....	HC-7927	773G TURBO (LOADERS)		Hydraulic Oil Filter.....	HC-55220
751 (LOADERS) KUBOTA V1903 , 1997-UP		Hydraulic Oil Filter.....	HC-55220	Hydraulic Oil Filter.....	HC-5507
Hydraulic Oil Filter.....	HC-55220	Hydraulic Oil Filter.....	HC-5507	Hydraulic Oil Filter.....	HC-55220
Hydraulic Oil Filter.....	HC-5507	775 (LOADERS) KUBOTA V2203		864 (LOADERS)	
751 (LOADERS)		Hydraulic Oil Filter.....	HC-5507	Hydraulic Oil Filter.....	HC-55220
Hydraulic Oil Filter.....	HC-5507	7753 (LOADERS)		Hydraulic Oil Filter.....	HC-5507
751 (LOADERS) PEUGEOT XUD9		Hydraulic Oil Filter.....	HC-5507	864G (LOADERS)	
Hydraulic Oil Filter.....	HC-5507	8300 (LOADERS)		Hydraulic Oil Filter.....	HC-5507
751G (LOADERS) KUBOTA V1903		Hydraulic Oil Filter.....	HC-5507	Hydraulic Oil Filter.....	HC-55220
Hydraulic Oil Filter.....	HC-5507	8400 (LOADERS)		873 (LOADERS) DEUTZ BF4M1011F	
752 (LOADERS)		Hydraulic Oil Filter.....	HC-5507	Hydraulic Oil Filter.....	HC-5507
Hydraulic Oil Filter.....	HC-5507	843 (LOADERS) ISUZU 4JB1		873 (LOADERS)	
		Hydraulic Oil Filter.....	HC-5507	Hydraulic Oil Filter.....	HC-5507
				Hydraulic Oil Filter.....	HC-55220



ENGINE APPLICATION

MODEL/APPLICATION	SAKURA NO	MODEL/APPLICATION	SAKURA NO	MODEL/APPLICATION	SAKURA NO
BOBCAT		BOBCAT		BOBCAT	
873G (LOADERS)		Hydraulic Oil Filter.....	HC-5507	S175 (LOADERS)	
Hydraulic Oil Filter.....	HC-5507	A300 (LOADERS)		Hydraulic Oil Filter.....	HC-55220
Hydraulic Oil Filter.....	HC-55220	Hydraulic Oil Filter.....	HC-5507	Hydraulic Oil Filter.....	HC-5507
883 (LOADERS)		Hydraulic Oil Filter.....	HC-55220	Hydraulic Oil Filter.....	HC-76100
KUBOTA V1903 , 1997-UP		A300 (LOADERS)		S175H (LOADERS)	
Hydraulic Oil Filter.....	HC-55220	TIER 3		KUBOTA V2203E	
883 (LOADERS)		Hydraulic Oil Filter.....	HC-5507	Hydraulic Oil Filter.....	HC-5507
Hydraulic Oil Filter.....	HC-55220	Hydraulic Oil Filter.....	HC-55220	S185 (LOADERS)	
Hydraulic Oil Filter.....	HC-5507	Hydraulic Oil Filter.....	HC-5504	Hydraulic Oil Filter.....	HC-55220
883G (LOADERS)		A300H (LOADERS)		Hydraulic Oil Filter.....	HC-5507
Hydraulic Oil Filter.....	HC-55220	KUBOTA V3300-DI , 2004-UP		Hydraulic Oil Filter.....	HC-76100
Hydraulic Oil Filter.....	HC-5507	Hydraulic Oil Filter.....	HC-76080	S185H (LOADERS)	
943 (LOADERS)		M970 (LOADERS)		Hydraulic Oil Filter.....	HC-5507
Hydraulic Oil Filter.....	HC-7927	CONTINEL F-227		S205H (LOADERS)	
Hydraulic Oil Filter.....	HC-19040	Hydraulic Oil Filter.....	H-51170	KUBOTA V2403 , 2005-UP	
Hydraulic Oil Filter.....	HC-5507	MT50 (LOADERS)		Hydraulic Oil Filter.....	HC-5507
943 (LOADERS)		2002-UP		S220 (LOADERS)	
Hydraulic Oil Filter.....	HC-7927	Hydraulic Oil Filter Full Flow.....	HC-7901	Hydraulic Oil Filter.....	HC-5507
943 (LOADERS)		S130 (LOADERS)		S220H (LOADERS)	
PERKINS 4.236		KUBOTA V2203-M-DI		KUBOTA V3300 , 2004-UP	
Hydraulic Oil Filter.....	HC-5507	Hydraulic Oil Filter.....	HC-5507	Hydraulic Oil Filter.....	HC-5507
Hydraulic Oil Filter.....	HC-7927	Hydraulic Oil Filter.....	HC-76100	S250 (LOADERS)	
953 (LOADERS)		S150 (LOADERS)		DEUTZ BF4M1011F	
S/N: 5131-UP		Hydraulic Oil Filter.....	HC-55220	Hydraulic Oil Filter.....	HC-5507
Hydraulic Oil Filter.....	HC-5507	Hydraulic Oil Filter.....	HC-5507	S250 (LOADERS)	
Hydraulic Oil Filter.....	HC-19040	Hydraulic Oil Filter.....	HC-76100	HYDRAULIC OIL FILTER	
963 (LOADERS)		S160 (LOADERS)		Hydraulic Oil Filter.....	HC-5507
Hydraulic Oil Filter.....	HC-5504	Hydraulic Oil Filter.....	HC-55220	S250H (LOADERS)	
963G (LOADERS)		Hydraulic Oil Filter.....	HC-5507	KUBOTA V3300-TE , 2003-UP	
Hydraulic Oil Filter.....	HC-1903	Hydraulic Oil Filter.....	HC-76100	Hydraulic Oil Filter.....	HC-76100
Hydraulic Oil Filter.....	HC-19040	Hydraulic Oil Filter.....	HC-55220	Hydraulic Oil Filter.....	HC-5504
Hydraulic Oil Filter.....	HC-5504	Hydraulic Oil Filter.....	HC-5507	S300H (LOADERS)	
970 (LOADERS)		S160 (LOADERS)		KUBOTA V3300DI-T	
CONTINEL F-227		TIER 4 - A3L3 11001		Hydraulic Oil Filter.....	HC-5507
Hydraulic Oil Filter.....	H-79411	Hydraulic Oil Filter.....	HC-76100	T190 (LOADERS)	
970 (LOADERS)		Hydraulic Oil Filter.....	HC-55220	Hydraulic Oil Filter.....	HC-5507
PERKINS		Hydraulic Oil Filter.....	HC-5507	T190H (LOADERS)	
Hydraulic Oil Filter.....	H-79411	S160 (LOADERS)		KUBOTA V2003T	
A220 (LOADERS)		TIER 4 - A3L4 11001		Hydraulic Oil Filter.....	HC-5507
DEUTZ BF4M1011F , 2002-UP		Hydraulic Oil Filter.....	HC-5507	T200 (LOADERS)	
Hydraulic Oil Filter.....	HC-5507	Hydraulic Oil Filter.....	HC-55220	Hydraulic Oil Filter.....	HC-5507
Hydraulic Oil Filter.....	HC-55220	Hydraulic Oil Filter.....	HC-76100	T250 (LOADERS)	
A220 (LOADERS)		S160 (LOADERS)		Hydraulic Oil Filter.....	HC-5507
Hydraulic Oil Filter.....	HC-5507	TIER 4 - AEYN 11001		T250 (LOADERS)	
A300 (LOADERS)		Hydraulic Oil Filter.....	HC-76100	Hydraulic Oil Filter.....	HC-5507
DEUTZ BF4M1011F		Hydraulic Oil Filter.....	HC-55220	T250 (LOADERS)	
Hydraulic Oil Filter.....	HC-55220	Hydraulic Oil Filter.....	HC-5507	Hydraulic Oil Filter.....	HC-5507



ENGINE APPLICATION

MODEL/APPLICATION	SAKURA NO	MODEL/APPLICATION	SAKURA NO	MODEL/APPLICATION	SAKURA NO
BOBCAT		BOMAG		BOMAG	
T2566 (HANDLER TELESCOPIC) PERKINS 1004-42 , 2002-UP Hydraulic Oil Filter.....	HC-57020	BW161AC (ROLLERS) KHD BF4L913 , 1987-UP Hydraulic Oil Filter.....	HC-6802	BW217PD (ROLLERS) DEUTZ , 1990-UP Hydraulic Oil Filter.....	HC-6802
T2566 (HANDLER TELESCOPIC) PERKINS 1004-40 Hydraulic Oil Filter.....	HC-57020	BW162A (COMPACTORS) 2001-UP Hydraulic Oil Filter.....	HC-6802	BW24R (ROLLERS) Hydraulic Oil Filter.....	HC-7913
T300 (DOZERS) KUBOTA V3300DI-T , 2008-UP Hydraulic Oil Filter.....	HC-76080	BW164AC (COMPACTORS) KHD BF4L913 , 1987-UP Hydraulic Oil Filter.....	HC-6802	K850 (COMPACTORS) CUMMINS Hydraulic Oil Filter.....	H-57030
T3071 (HANDLER TELESCOPIC) PERKINS 1004-42 , 2002-UP Hydraulic Oil Filter.....	HC-57020	BW172 (ROLLERS) DEUTZ F4L912 Hydraulic Oil Filter.....	HC-6802	K851 (COMPACTORS) CUMMINS Hydraulic Oil Filter.....	H-57030
V417 (FORKLIFTS) KUBOTA V3300T Hydraulic Oil Filter.....	HC-5507	BW154 (COMPACTORS) DEUTZ F4L912 , 2001-UP Hydraulic Oil Filter.....	HC-6802	MPH100R (COMPACTORS) DETROITD 8V-71 Hydraulic Oil Filter.....	H-51170
BOBARD		BW160AD2 (ROLLERS) DEUTZ Hydraulic Oil Filter.....	HC-6802	MPH100R (COMPACTORS) Hydraulic Oil Filter.....	HC-55240
B 45 (TRACTORS) Hydraulic Oil Filter Transmission...	HC-45150	BW166ADMK1 (COMPACTORS) DEUTZ F4L912 , 2001-UP Hydraulic Oil Filter.....	HC-6802	S812A (PAVING EQUIPMENT) DETROITD 3-53 Hydraulic Oil Filter Transmission...	H-65030
K-45 (TRACTORS) Hydraulic Oil Filter Transmission...	HC-45150	BW201AD (ROLLERS) DEUTZ Hydraulic Oil Filter.....	HC-6802	BRAUD	
BOMAG		BW202AD (ROLLERS) KHD BF4L913 , 1987-UP Hydraulic Oil Filter.....	HC-6802	1620 (AGRICULTURE) FIAT FIAT Hydraulic Oil Filter.....	HC-7906
BW141 (ROLLERS) DEUTZ Hydraulic Oil Filter.....	HC-6802	BW212PD (ROLLERS) DEUTZ Hydraulic Oil Filter.....	HC-62020	1620 (HARVESTERS) FIAT Hydraulic Oil Filter.....	HC-7906
BW141-66AD (VIBRATORS) KHD F4L912 Hydraulic Oil Filter.....	HC-6802	BW213A (ROLLERS) DEUTZ Hydraulic Oil Filter.....	HC-6802	2620 (AGRICULTURE) 2620 Hydraulic Oil Filter.....	HC-7906
BW141AC (COMPACTORS) DEUTZ F4L912 Hydraulic Oil Filter.....	HC-6802	BW213D-2 (ROLLERS) KHD BF4L913 Hydraulic Oil Filter.....	HC-6802	2620 (AGRICULTURE) Hydraulic Oil Filter.....	HC-7906
BW142 (ROLLERS) DEUTZ F3L912 Hydraulic Oil Filter.....	HC-6802	BW213PDB (ROLLERS) DEUTZ Hydraulic Oil Filter.....	HC-62020	SB 56 (HARVESTERS) Hydraulic Oil Filter.....	HC-7906
BW142 PDB (COMPACTORS) DEUTZ F4L912 , 2001-UP Hydraulic Oil Filter.....	HC-6802	BW214D (ROLLERS) DEUTZ Hydraulic Oil Filter.....	HC-62020	BRANSON	
BW151AC (ROLLERS) DEUTZ Hydraulic Oil Filter.....	HC-6802	BW215D (VIBRATORS) KHD F6L413V/FR Hydraulic Oil Filter.....	HC-62020	3820 (TRACTORS) KUKJE 1.8L 4-CYL , 1800 Hydraulic Oil Filter.....	HC-79540
BW160A (COMPACTORS) DEUTZ F4L912 Hydraulic Oil Filter.....	HC-6802	BW217D (ROLLERS) DEUTZ Hydraulic Oil Filter.....	HC-6802	BROS	
BW160AC (ROLLERS) DEUTZ Hydraulic Oil Filter.....	HC-6802			SUPER-PACTOR SSP-446P (PAVING EQUIPMENT) DETROITD 8V-71 Hydraulic Oil Filter Transmission...	H-65030
BW160AD1 (ROLLERS) DEUTZ Hydraulic Oil Filter.....	HC-6802			BROYT	
				X20 (EXCAVATORS) MWM Hydraulic Oil Filter.....	H-85110



ENGINE APPLICATION

MODEL/APPLICATION	SAKURA NO	MODEL/APPLICATION	SAKURA NO	MODEL/APPLICATION	SAKURA NO
BROYT		BUFFALO-SPRINGFIELD		CASE	
X20 (EXCAVATORS) PERKINS 6.354 Hydraulic Oil Filter.....	H-85110	BYRON		1187 (EXCAVATORS) CASE DETROIT Hydraulic Oil Filter Transmission...	H-65030
X21 (EXCAVATORS) PERKINS 6.354.4 Hydraulic Oil Filter.....	H-85110	8400 (COMBINES) Hydraulic Oil Filter.....	HC-5504	1188CK (EXCAVATORS) Hydraulic Oil Filter.....	HC-5506
X21 (EXCAVATORS) PERKINS T6.354.4 Hydraulic Oil Filter.....	H-85110	CARRARO		Hydraulic Oil Filter.....	H-5107
X30 (EXCAVATORS) BROYT TD70B Hydraulic Oil Filter.....	H-85110	501.4 (TRACTORS) PERKINS Hydraulic Oil Filter.....	HC-51040	120 CRAWLER (EXCAVATORS) Hydraulic Oil Filter.....	H-57030
X30 (EXCAVATORS) VOLVO D70 Hydraulic Oil Filter.....	H-85110	920.4 (TRACTORS) PERKINS 4.318 Hydraulic Oil Filter.....	HC-51040	125CK CRAWLER SERIES B (EXCAVATORS) Hydraulic Oil Filter.....	H-71140
X41 (EXCAVATORS) VOLVO TD100 , 1980-UP Hydraulic Oil Filter.....	H-85110	CASAGRANDE		Hydraulic Oil Filter.....	H-76050
X41 (EXCAVATORS) CAT 3306T Hydraulic Oil Filter.....	H-85110	B155E (DRILLING) CAT 3116T Hydraulic Oil Filter.....	HC-5505	125PB (EXCAVATORS) Hydraulic Oil Filter.....	H-71140
X50 (EXCAVATORS) TO-1980 Hydraulic Oil Filter.....	H-85110	Hydraulic Oil Filter.....	H-7942	Hydraulic Oil Filter.....	H-76050
BUCYRUS-ERIE		Hydraulic Oil Filter.....	HC-5801	1280 (EXCAVATORS) CASE DETROIT Hydraulic Oil Filter.....	H-57030
40R (CRANES) CUMMINS NTC-855 Hydraulic Oil Filter.....	H-7976	CASE		1280 (EXCAVATORS) CASE Hydraulic Oil Filter.....	H-57030
50R (CRANES) BUCYRUSE ELECTRIC Hydraulic Oil Filter.....	H-7976	1055 (TRACTORS) CASE D-358 Hydraulic Oil Filter.....	H-5408	1288CK (EXCAVATORS) Hydraulic Oil Filter.....	H-5107
61R (CRANES) GARDNER DENVER (S/N: 132448-132448) Hydraulic Oil Filter.....	H-5405	1080 (EXCAVATORS) Hydraulic Oil Filter Transmission...	H-65030	1455XL (TRACTORS) IHC DT402 Hydraulic Oil Filter.....	H-5409
61R (CRANES) INGERSOL PA-250V Hydraulic Oil Filter.....	H-5405	1085C (EXCAVATORS) Hydraulic Oil Filter.....	HC-5506	1450B (CRAWLERS) Hydraulic Oil Filter.....	HC-5506
61R (CRANES) Hydraulic Oil Filter.....	H-5517	Hydraulic Oil Filter.....	HC-5508	150 (SKIDDERS) Hydraulic Oil Filter.....	H-79411
GD-25C (CRANES) CAT 3206 Hydraulic Oil Filter Transmission... Hydraulic Oil Filter.....	H-65030 H-7985	115 (EXCAVATORS) Hydraulic Oil Filter.....	H-71140	1526 (LOADERS) CASE Hydraulic Oil Filter.....	H-79411
GD35T (CRANES) CAT 3406 Hydraulic Oil Filter.....	H-5517	Hydraulic Oil Filter.....	H-76050	1527 (SKIDDERS) CASE Hydraulic Oil Filter.....	H-79411
BUFFALO-SPRINGFIELD		1150E (CRAWLERS) CASE 6-830 Hydraulic Oil Filter.....	HC-5506	160CK CRAWLER (EXCAVATORS) Hydraulic Oil Filter.....	H-85110
RUBBER TIRE ROLLER (ROLLERS) Hydraulic Oil Filter Transmission...	H-65030	1150E (CRAWLERS) CASE 6T590 Hydraulic Oil Filter.....	HC-5506	Hydraulic Oil Filter.....	H-71140
		1150E (CRAWLERS) CASE 6T830 Hydraulic Oil Filter.....	HC-5506	1650K (CRAWLERS) CUMMINS 6BTAS.9-C (S/N: TIER II-UP) , 2003-UP Hydraulic Oil Filter.....	HC-5508
		1150H (CRAWLERS) Hydraulic Oil Filter.....	HC-5506	170B CRAWLER (EXCAVATORS)	



ENGINE APPLICATION

MODEL/APPLICATION	SAKURA NO	MODEL/APPLICATION	SAKURA NO	MODEL/APPLICATION	SAKURA NO
CASE		CASE		CASE	
170B CRAWLER (EXCAVATORS)		2120 PRO-SERIE (AGRICULTURE) PERKINS 1000.3 A , 1985-2002		Hydraulic Oil Filter.....	H-5410
Hydraulic Oil Filter.....	H-85110	Hydraulic Oil Filter.....	HC-7907	2500B (AGRICULTURE)	
170C (EXCAVATORS)		Hydraulic Oil Filter.....	HC-7907	2500B	
Hydraulic Oil Filter.....	H-85110	2130 (AGRICULTURE)		Hydraulic Oil Filter.....	H-5410
1737 (SKIDDERS)		Hydraulic Oil Filter.....	HC-7907	Hydraulic Oil Filter.....	H-7999
CASE		Hydraulic Oil Filter.....	HC-7907	2500B (TRACTORS)	
Hydraulic Oil Filter.....	H-79411	2130 PRO-SERIE (AGRICULTURE) PERKINS 1000.3 A , 1985-2002		Hydraulic Oil Filter.....	H-5410
1740 (SKIDDERS)		Hydraulic Oil Filter.....	HC-7907	250A (TRACTORS)	
CASE G-188D		Hydraulic Oil Filter.....	HC-7907	Hydraulic Oil Filter.....	H-5410
Hydraulic Oil Filter.....	H-79411	2140 (AGRICULTURE)		2504 SERIES (TRACTORS)	
1818 (LOADERS)		Hydraulic Oil Filter.....	HC-7907	CASE C-153	
CASE		Hydraulic Oil Filter.....	HC-7907	Hydraulic Oil Filter.....	H-5405
Hydraulic Oil Filter Full Flow.....	HC-7935	2150 (AGRICULTURE)		2504 SERIES (TRACTORS)	
1825B (SKIDDERS)		Hydraulic Oil Filter.....	HC-7907	CASE D-188	
Hydraulic Oil Filter.....	HC-57020	Hydraulic Oil Filter.....	HC-7907	Hydraulic Oil Filter.....	H-5405
1825 (LOADERS)		220B (EXCAVATORS)		2606 SERIES (TRACTORS)	
CASE		Hydraulic Oil Filter.....	H-71140	CASE C-221	
Hydraulic Oil Filter.....	HC-57020	Hydraulic Oil Filter.....	H-71140	Hydraulic Oil Filter.....	H-5405
1838 (SKIDDERS)		220C CRAWLER (EXCAVATORS)		2606 SERIES (TRACTORS)	
Hydraulic Oil Filter.....	HC-7972	Hydraulic Oil Filter.....	H-71140	CASE D-236	
1835B (SKIDDERS)		2366 (COMBINES)		Hydraulic Oil Filter.....	H-5405
CASE		Hydraulic Oil Filter.....	HC-76080	2670 (TRACTORS)	
Hydraulic Oil Filter.....	HC-7972	2388 (COMBINES)		Hydraulic Oil Filter Full Flow.....	HC-79331
1835C (SKIDDERS)		Hydraulic Oil Filter.....	HC-76080	2870 (TRACTORS)	
CASE		2400A (CONSTRUCTION & MINING)		Hydraulic Oil Filter Full Flow.....	HC-79331
Hydraulic Oil Filter.....	HC-7972	2400A		300 C (SKIDDERS)	
1835C (SKIDDERS)		Hydraulic Oil Filter.....	H-7999	Hydraulic Oil Filter.....	H-79411
STANADYN 150		2400A (TRACTORS)		300SK (SKIDDERS)	
Hydraulic Oil Filter.....	HC-7972	Hydraulic Oil Filter.....	H-5410	Hydraulic Oil Filter.....	H-79411
1840 (SKIDDERS)		2400B (AGRICULTURE)		300 CRAWLER (EXCAVATORS)	
Hydraulic Oil Filter.....	HC-7972	2400B		Hydraulic Oil Filter.....	H-85110
1845C (SKIDDERS)		Hydraulic Oil Filter.....	H-5410	303 (COMBINES)	
Hydraulic Oil Filter.....	HC-7972	Hydraulic Oil Filter.....	H-7999	CASE C-221	
1845 (SKIDDERS)		2400B (TRACTORS)		Hydraulic Oil Filter.....	H-5405
CASE		Hydraulic Oil Filter.....	H-5410	303 (COMBINES)	
Hydraulic Oil Filter.....	H-79411	240A (TRACTORS)		CASE BD-220	
1845B (LOADERS)		Hydraulic Oil Filter.....	H-5410	Hydraulic Oil Filter.....	H-5405
CASE		2470 (TRACTORS)		30ECYC SERIES A CRAWLER (EXCAVATORS)	
Hydraulic Oil Filter.....	HC-7972	Hydraulic Oil Filter.....	H-5410	Hydraulic Oil Filter.....	H-79411
200-250RF2 (CRANES)		2500A (TRACTORS)		30YM-30YC CRAWLER (EXCAVATORS)	
GMC		Hydraulic Oil Filter Full Flow.....	HC-79331	GMC	
Hydraulic Oil Filter.....	H-79411			Hydraulic Oil Filter.....	H-79411
200-250RF2 (CRANES)					
IHC					
Hydraulic Oil Filter.....	H-79411				



ENGINE APPLICATION

MODEL/APPLICATION	SAKURA NO	MODEL/APPLICATION	SAKURA NO	MODEL/APPLICATION	SAKURA NO
CASE		CASE		CASE	
30YM-30YC CRAWLER (EXCAVATORS) IHC		Hydraulic Oil Filter.....	H-79411	400 FOLD & FLEX (FARM EQUIPMENT)	
Hydraulic Oil Filter.....	H-79411	35ECYC Series B (EXCAVATORS) CASE (S/N: 300-UP)		Hydraulic Oil Filter.....	HC-69030
310E (CONSTRUCTION & MINING) with G188D Engine		Hydraulic Oil Filter.....	H-79411	403 (COMBINES) CASE C-263	
Hydraulic Oil Filter.....	H-5640	35ECYC Series B (EXCAVATORS) DETROIT DIESEL		Hydraulic Oil Filter.....	H-5405
315 (COMBINES) CASE		Hydraulic Oil Filter.....	H-79411	403 (COMBINES) CASE D-282	
Hydraulic Oil Filter.....	H-5405	35ECYC Series B (EXCAVATORS) DETROIT DIESEL (S/N: 300-UP)		Hydraulic Oil Filter.....	H-5405
3220 (AGRICULTURE) 3220		Hydraulic Oil Filter.....	H-79411	403 (COMBINES) CASE D-301	
Hydraulic Oil Filter.....	H-7999	360 (TRENCHERS) CASE		Hydraulic Oil Filter.....	H-5405
3230 (AGRICULTURE) 3230		Hydraulic Oil Filter.....	HC-5508	403 (COMBINES) CASE LPG	
Hydraulic Oil Filter.....	H-7999	3616 (TRACTORS) CASE C-221		Hydraulic Oil Filter.....	H-5405
3388 (AGRICULTURE) CASE DT-436		Hydraulic Oil Filter.....	H-5405	403 HILLSIDE (COMBINES) CASE	
Hydraulic Oil Filter.....	H-5410	3616D (TRACTORS) CASE D-236		Hydraulic Oil Filter.....	H-5405
Hydraulic Oil Filter.....	H-5410	Hydraulic Oil Filter.....	H-5405	403 HILLSIDE (COMBINES) CASE C-282	
350 (CONSTRUCTION & MINING)		3788 (AGRICULTURE) CASE DT-436		Hydraulic Oil Filter.....	H-5405
Hydraulic Oil Filter.....	H-7936	Hydraulic Oil Filter.....	H-5410	40A WHEEL (EXCAVATORS) S/N: 100-2199	
Hydraulic Oil Filter.....	H-7936	Hydraulic Oil Filter.....	H-5410	Hydraulic Oil Filter.....	H-79411
350B (CRAWLERS)		380CK (BACKHOE LOADERS)		40B (EXCAVATORS) CUMMINS (S/N: 2200-6292775)	
Hydraulic Oil Filter.....	HC-5508	Hydraulic Oil Filter.....	H-7936	Hydraulic Oil Filter.....	H-79411
Hydraulic Oil Filter.....	H-7936	380CK-LL (BACKHOE LOADERS)		40B (EXCAVATORS) DETROIT DIESEL	
3514 (TRACTORS) CASE C-153		Hydraulic Oil Filter.....	H-7936	Hydraulic Oil Filter.....	H-79411
Hydraulic Oil Filter.....	H-5405	385 (AGRICULTURE) CASE CASEI		Hydraulic Oil Filter Transmission...	H-65030
3514D (TRACTORS) CASE D-239		Hydraulic Oil Filter.....	H-7999	40B (EXCAVATORS) DETROIT DIESEL (S/N: 2200-6292775)	
Hydraulic Oil Filter.....	H-5405	395 (AGRICULTURE) 395		Hydraulic Oil Filter.....	H-79411
3514D (TRACTORS) CASE D-188		Hydraulic Oil Filter.....	H-5410	Hydraulic Oil Filter Transmission...	H-65030
Hydraulic Oil Filter.....	H-5405	Hydraulic Oil Filter.....	H-7999	40B (LOGGERS) CASE	
3588 (AGRICULTURE) CASE DT-436		395 (TRACTORS)		Hydraulic Oil Filter.....	H-79411
Hydraulic Oil Filter.....	H-5410	Hydraulic Oil Filter.....	H-5410	40D (EXCAVATORS) S/N: 6292576-UP	
3588 (AGRICULTURE) IHC DT466		400 (SKIDDERS)		Hydraulic Oil Filter.....	H-79411
Hydraulic Oil Filter.....	H-5410	Hydraulic Oil Filter Transmission...	H-65030	40E (EXCAVATORS) DETROIT DIESEL	
Hydraulic Oil Filter.....	H-5410	Hydraulic Oil Filter.....	H-79411	Hydraulic Oil Filter Transmission...	H-65030
35D (EXCAVATORS) CASE (S/N: 6266131-UP)		400 (TRACTORS) DETROIT D 4-53		40E (EXCAVATORS) S/N: 6292991-UP	
Hydraulic Oil Filter Transmission...	H-65030	Hydraulic Oil Filter.....	H-79411	Hydraulic Oil Filter Transmission...	H-65030
35D (EXCAVATORS) DETROIT DIESEL (S/N: 6266131-UP)		40 (CONSTRUCTION EQUIPMENTS) CASE 504BT		40ECYC SERIES B (EXCAVATORS) CASE (S/N: 1500-UP)	
Hydraulic Oil Filter Transmission...	H-65030	Hydraulic Oil Filter.....	H-79411	Hydraulic Oil Filter.....	H-79411
35ECYC Series B (EXCAVATORS) CASE		400 CRAWLER (EXCAVATORS)			
		Hydraulic Oil Filter.....	H-85110		



ENGINE APPLICATION

MODEL/APPLICATION	SAKURA NO	MODEL/APPLICATION	SAKURA NO	MODEL/APPLICATION	SAKURA NO
CASE		CASE		CASE	
40ECYC SERIES B (EXCAVATORS) DETROIT DIESEL (S/N: 1500-UP)		430 SERIES 3 (SKIDDERS)		450B (CRAWLERS)	
Hydraulic Oil Filter.....	H-79411	Hydraulic Oil Filter.....	HC-5508	Hydraulic Oil Filter.....	HC-5508
40ECYC CRAWLER (EXCAVATORS) CUMMINS 6V-352		431 (TRACTORS) CASE G-148B		450C (CRAWLERS)	
Hydraulic Oil Filter.....	H-79411	Hydraulic Oil Filter.....	H-5640	Hydraulic Oil Filter.....	HC-5508
40ECYC CRAWLER (EXCAVATORS) GMC 4-71		433 (TRACTORS) CASE D-155		450 SERIES 3 (SKIDDERS)	
Hydraulic Oil Filter.....	H-79411	Hydraulic Oil Filter.....	H-5408	Hydraulic Oil Filter.....	HC-5508
40ECYC CRAWLER (EXCAVATORS) GMC 4-53		435 (SKIDDERS)		450CT (LOADERS)	
Hydraulic Oil Filter.....	H-79411	Hydraulic Oil Filter.....	HC-5508	Hydraulic Oil Filter.....	HC-5508
40ECYC CRAWLER (EXCAVATORS) PERKINS 6.354		435 SERIES 3 (SKIDDERS)		450CT SERIES III (LOADERS)	
Hydraulic Oil Filter.....	H-79411	Hydraulic Oil Filter.....	HC-5508	Hydraulic Oil Filter.....	HC-5508
40F WHEEL (EXCAVATORS)		440 SERIES 3 (SKIDDERS)		460 (TRENCHERS)	
Hydraulic Oil Filter Transmission...	H-65030	Hydraulic Oil Filter.....	HC-5508	Hydraulic Oil Filter.....	HC-7972
40XT (SKIDDERS)		440CT SERIES III (LOADERS)		465 (SKIDDERS)	
Hydraulic Oil Filter.....	HC-7972	Hydraulic Oil Filter.....	HC-5508	Hydraulic Oil Filter.....	HC-5508
Hydraulic Oil Filter.....	HC-5508	445 SERIES 3 (SKIDDERS)		465 SERIES 3 (SKIDDERS)	
410 (SKIDDERS)		Hydraulic Oil Filter.....	HC-5508	Hydraulic Oil Filter.....	HC-5508
Hydraulic Oil Filter.....	HC-5508	445CT (LOADERS)		4690 (TRACTORS)	
410 SERIES 3 (SKIDDERS)		Hydraulic Oil Filter.....	HC-5508	Hydraulic Oil Filter.....	HC-57020
Hydraulic Oil Filter.....	HC-5508	445CT SERIES III (LOADERS) S/N: N8M496460-UP , 2009-UP		475 (AGRICULTURE) CASE 301B	
4140 (AGRICULTURE) CHRYSLER 4 CYL		Hydraulic Oil Filter.....	HC-5504	Hydraulic Oil Filter.....	HC-5511
Hydraulic Oil Filter.....	HC-5511	4490 (TRACTORS)		475 (AGRICULTURE) CASE 336 10018986	
Hydraulic Oil Filter.....	HC-5511	Hydraulic Oil Filter.....	HC-57020	Hydraulic Oil Filter.....	HC-5511
420 SERIES 3 (SKIDDERS)		450 (CONSTRUCTION & MINING) CASE 207 3060306		475 (AGRICULTURE) CASE 336 10018987	
Hydraulic Oil Filter.....	HC-5508	Hydraulic Oil Filter.....	H-7936	Hydraulic Oil Filter.....	HC-5511
420CT SERIES III (LOADERS)		450 (CRAWLERS) CASE 207 (S/N: 3060306-UP)		475 (TRACTORS) CASE 301B	
Hydraulic Oil Filter.....	HC-5508	Hydraulic Oil Filter.....	H-7936	Hydraulic Oil Filter.....	HC-5511
4210 (AGRICULTURE) 4210		450 (CRAWLERS) S/N: T0-3060306		475 (TRACTORS) CASE 336 (S/N: 10018987-UP)	
Hydraulic Oil Filter.....	H-7999	Hydraulic Oil Filter.....	H-5640	Hydraulic Oil Filter.....	HC-5511
4230 (AGRICULTURE) 4230		Hydraulic Oil Filter.....	H-7936	475 (TRACTORS) CASE 336 (S/N: T0-10018986)	
Hydraulic Oil Filter.....	H-7999	450 (SKIDDERS)		Hydraulic Oil Filter.....	HC-5511
4240 (AGRICULTURE) 4240		Hydraulic Oil Filter.....	HC-5508	480B (BACKHOE LOADERS) CASE G-188D	
Hydraulic Oil Filter.....	H-7999	450D (AGRICULTURE) CASE G207D		Hydraulic Oil Filter.....	H-7936
430 (SKIDDERS)		Hydraulic Oil Filter.....	H-7936	Hydraulic Oil Filter.....	H-5640
Hydraulic Oil Filter.....	HC-5508	Hydraulic Oil Filter.....	H-7936	Hydraulic Oil Filter.....	H-7936



ENGINE APPLICATION

MODEL/APPLICATION	SAKURA NO	MODEL/APPLICATION	SAKURA NO	MODEL/APPLICATION	SAKURA NO
CASE		CASE		CASE	
480C (BACKHOE LOADERS)		521DXT (LOADERS)		Hydraulic Oil Filter.....	HC-7972
Hydraulic Oil Filter.....	H-7936	Hydraulic Oil Filter.....	HC-5506	570L (TRACTORS)	
480D (LOADERS)		530 (FORKLIFTS)		Hydraulic Oil Filter.....	HC-5508
Hydraulic Oil Filter.....	HC-5508	Hydraulic Oil Filter.....	H-5640	570LXT (LOADERS)	
480E (LOADERS)		530CK (FORKLIFTS)		Hydraulic Oil Filter.....	HC-45050
Hydraulic Oil Filter.....	HC-5508	Hydraulic Oil Filter.....	H-5640	Hydraulic Oil Filter.....	HC-5508
484 (AGRICULTURE) CASE D-179		531 (AGRICULTURE) CASE G-159		570M (TRACTORS)	
Hydraulic Oil Filter.....	H-7999	Hydraulic Oil Filter.....	H-7936	Hydraulic Oil Filter.....	HC-5508
4849 (TRACTORS)		Hydraulic Oil Filter.....	H-5640	Hydraulic Oil Filter.....	HC-45050
Hydraulic Oil Filter.....	HC-7909	Hydraulic Oil Filter.....	H-7936	580 (AGRICULTURE) CASE G-159	
485 (AGRICULTURE) 485		531 (TRACTORS) CASE G-188D		Hydraulic Oil Filter.....	H-7936
Hydraulic Oil Filter.....	H-5410	Hydraulic Oil Filter.....	H-5640	580 (AGRICULTURE) CASE G-188D	
Hydraulic Oil Filter.....	H-7999	533 (TRACTORS) CASE D-155		Hydraulic Oil Filter.....	H-7936
495 (AGRICULTURE) 495		Hydraulic Oil Filter.....	H-5408	Hydraulic Oil Filter.....	H-7936
Hydraulic Oil Filter.....	H-7999	540 (AGRICULTURE) CASE G-159		580 (TRACTORS) CASE G-159	
4994 (TRACTORS)		Hydraulic Oil Filter.....	H-7936	Hydraulic Oil Filter.....	H-5640
Hydraulic Oil Filter.....	HC-5506	Hydraulic Oil Filter.....	H-5408	Hydraulic Oil Filter.....	H-7936
503 (COMBINES) CASE		Hydraulic Oil Filter.....	H-5640	580 (TRACTORS) CASE G-188D	
Hydraulic Oil Filter.....	H-5405	Hydraulic Oil Filter.....	H-7936	Hydraulic Oil Filter.....	H-5640
503 (COMBINES) S/N: 5706-UP		540 (TRACTORS) CASE G-188D		Hydraulic Oil Filter.....	H-7936
Hydraulic Oil Filter.....	H-5405	Hydraulic Oil Filter.....	H-5640	580 (TRACTORS) CASE G207A	
503 (COMBINES) S/N: T0-5706		541 (AGRICULTURE) CASE G-159		Hydraulic Oil Filter.....	HC-5508
Hydraulic Oil Filter.....	H-5405	Hydraulic Oil Filter.....	H-7936	580 SLE (BACKHOE LOADERS) CUMMINS 4BT3.9	
50D CRAWLER (EXCAVATORS) S/N: 6279926-UP		Hydraulic Oil Filter.....	H-5408	Hydraulic Oil Filter.....	HC-45050
Hydraulic Oil Filter.....	H-57030	550 (CRAWLERS)		Hydraulic Oil Filter.....	HC-5508
Hydraulic Oil Filter Transmission...	H-65030	Hydraulic Oil Filter.....	HC-5508	580 SLE (BACKHOE LOADERS)	
50E (CRAWLERS)		550G (CRAWLERS)		Hydraulic Oil Filter.....	HC-5508
Hydraulic Oil Filter.....	H-57030	Hydraulic Oil Filter.....	HC-5508	Hydraulic Oil Filter.....	HC-45050
Hydraulic Oil Filter Transmission...	H-65030	550H (CRAWLERS)		580 SUPER E (BACKHOE LOADERS) CONSOLDI 4-390	
Hydraulic Oil Filter.....	H-57030	Hydraulic Oil Filter.....	HC-5508	Hydraulic Oil Filter.....	HC-5508
50EC SERIES B CRAWLER (EXCAVATORS) S/N: 550-UP		550D (DOZERS)		580 SUPER E (TRACTORS) CUMMINS 4B3.9	
Hydraulic Oil Filter.....	H-79411	Hydraulic Oil Filter.....	HC-5508	Hydraulic Oil Filter.....	HC-5508
521D (LOADERS)		554 (TRACTORS)		580 SUPER K (BACKHOE LOADERS) CONSOLDI 4T3.9 , 1991	
Hydraulic Oil Filter Transmission...	HC-76130	Hydraulic Oil Filter.....	H-5409	Hydraulic Oil Filter.....	HC-5508
Hydraulic Oil Filter.....	HC-5506	560 (TRENCHERS)		580 SUPER K (BACKHOE LOADERS)	



ENGINE APPLICATION

MODEL/APPLICATION	SAKURA NO	MODEL/APPLICATION	SAKURA NO	MODEL/APPLICATION	SAKURA NO
CASE		CASE		CASE	
580 SUPER K (BACKHOE LOADERS)		Hydraulic Oil Filter.....	HC-5508	Hydraulic Oil Filter Transmission...	HC-2701
Hydraulic Oil Filter.....	HC-5508	584G (FORKLIFTS)		Hydraulic Oil Filter.....	HC-5508
580B (AGRICULTURE) CASE G-159		Hydraulic Oil Filter.....	HC-5508	621B (LOADERS)	
Hydraulic Oil Filter.....	H-7936	Hydraulic Oil Filter.....	HC-45050	Hydraulic Oil Filter Transmission...	HC-2701
Hydraulic Oil Filter.....	H-5640	585 (AGRICULTURE) 585		Hydraulic Oil Filter.....	HC-5508
Hydraulic Oil Filter.....	H-7936	Hydraulic Oil Filter.....	H-7999	621BXT (LOADERS)	
580K (LOADERS) CONSOLDI 4T3.9		Hydraulic Oil Filter.....	H-5410	Hydraulic Oil Filter.....	HC-5508
Hydraulic Oil Filter.....	HC-5508	585 (CONSTRUCTION & MINING)		Hydraulic Oil Filter Transmission...	HC-2701
580CK (FORKLIFTS)		Hydraulic Oil Filter.....	H-7936	Hydraulic Oil Filter.....	H-7961
Hydraulic Oil Filter.....	H-5640	585L (TRACTORS)		621D (LOADERS)	
Hydraulic Oil Filter.....	H-7936	Hydraulic Oil Filter.....	H-5410	Hydraulic Oil Filter.....	HC-5506
Hydraulic Oil Filter.....	H-7936	586 (CONSTRUCTION & MINING)		Hydraulic Oil Filter Transmission..	HC-76130
580CKB (BACKHOE LOADERS)		Hydraulic Oil Filter.....	H-7936	621 E (LOADERS) TIER 3 , 2008	
Hydraulic Oil Filter.....	H-7936	588 (LOADERS) CASE 4T-390		Hydraulic Oil Filter.....	HC-5512
580G (BACKHOE LOADERS) CASE		Hydraulic Oil Filter.....	HC-5506	6388 (AGRICULTURE) IHC DT466B	
Hydraulic Oil Filter.....	HC-5508	588G (FORKLIFTS)		Hydraulic Oil Filter.....	H-5410
580SR (BACKHOE LOADERS) 2004-UP		Hydraulic Oil Filter.....	HC-45050	6388 (TRACTORS) IHC DT466B	
Hydraulic Oil Filter.....	HC-57020	Hydraulic Oil Filter.....	HC-5508	Hydraulic Oil Filter.....	H-5410
580 SUPER L (BACKHOE LOADERS)		590 (BACKHOE LOADERS) CONSOLDI CDC ENGINE		640 (AGRICULTURE) 640	
Hydraulic Oil Filter.....	HC-5508	Hydraulic Oil Filter.....	HC-5508	Hydraulic Oil Filter.....	H-5408
Hydraulic Oil Filter.....	HC-45050	590 SUPER L (BACKHOE LOADERS)		640 (TRACTORS)	
580 SUPER M (BACKHOE LOADERS)		Hydraulic Oil Filter.....	HC-45050	Hydraulic Oil Filter.....	H-5408
Hydraulic Oil Filter.....	HC-5508	Hydraulic Oil Filter.....	HC-5508	644 (TRACTORS)	
584 (AGRICULTURE) CASE CASEI		595 (AGRICULTURE) 595		Hydraulic Oil Filter.....	H-5408
Hydraulic Oil Filter.....	H-5410	Hydraulic Oil Filter.....	H-7999	Hydraulic Oil Filter.....	H-5409
Hydraulic Oil Filter.....	H-7999	602D (COMPACTORS) DEUTZ		650 (CRAWLERS)	
584 (CONSTRUCTION & MINING)		Hydraulic Oil Filter.....	HC-1822	Hydraulic Oil Filter.....	HC-5508
Hydraulic Oil Filter.....	H-7936	60C (EXCAVATORS)		650G (CRAWLERS) CASE 4T-390	
Hydraulic Oil Filter.....	H-7936	Hydraulic Oil Filter.....	H-71140	Hydraulic Oil Filter.....	HC-5508
584 (TRACTORS) CASE		616 (COTTON PICKERS) CASE		650H (CRAWLERS)	
Hydraulic Oil Filter.....	H-5410	Hydraulic Oil Filter.....	H-5405	Hydraulic Oil Filter.....	HC-5508
584C (FORKLIFTS)		616 (COTTON PICKERS)		6588 (AGRICULTURE) IHC DT466B	
Hydraulic Oil Filter.....	H-7936	Hydraulic Oil Filter.....	H-5405	Hydraulic Oil Filter.....	H-5410
Hydraulic Oil Filter.....	HC-5508	621 (CONSTRUCTION & MINING)		660 (TRENCHERS)	
584CK (TRACTORS)		Hydraulic Oil Filter.....	H-7961	Hydraulic Oil Filter.....	HC-7972
Hydraulic Oil Filter.....	H-7936	Hydraulic Oil Filter Transmission...	HC-2701	6788 (AGRICULTURE) IHC DT466B	
584E (FORKLIFTS)		Hydraulic Oil Filter.....	H-7961	Hydraulic Oil Filter.....	H-5410



ENGINE APPLICATION

MODEL/APPLICATION	SAKURA NO	MODEL/APPLICATION	SAKURA NO	MODEL/APPLICATION	SAKURA NO
CASE		CASE		CASE	
680 (TRACTORS) CASE A267D		721B (LOADERS)		784 (AGRICULTURE) CASE CASEI	
Hydraulic Oil Filter.....	H-5640	Hydraulic Oil Filter.....	HC-5508	Hydraulic Oil Filter.....	H-7999
680K (LOADERS) CASE 6-590		Hydraulic Oil Filter Transmission...	HC-2701	Hydraulic Oil Filter.....	H-5410
Hydraulic Oil Filter.....	HC-7913	721C (LOADERS)		784 (TRACTORS) CASE	
680CKH (BACKHOE LOADERS)		Hydraulic Oil Filter.....	HC-5508	Hydraulic Oil Filter.....	H-5410
Hydraulic Oil Filter.....	HC-7913	Hydraulic Oil Filter Transmission..	HC-76130	800 540 RPM PTO (FARM EQUIPMENT)	
Hydraulic Oil Filter Full Flow.....	HC-79331	721D (LOADERS) 2004-UP		Hydraulic Oil Filter.....	HC-69030
680H (BACKHOE LOADERS)		Hydraulic Oil Filter.....	HC-5504	800R (EXCAVATORS)	
Hydraulic Oil Filter.....	HC-7913	721E (LOADERS) S/N: TIER III-UP , 2006-UP		Hydraulic Oil Filter.....	H-79411
Hydraulic Oil Filter Full Flow.....	HC-79331	Hydraulic Oil Filter Transmission..	HC-76130	80B WHEEL (EXCAVATORS)	
680L (BACKHOE LOADERS)		Hydraulic Oil Filter.....	HC-5504	Hydraulic Oil Filter.....	H-57030
Hydraulic Oil Filter.....	HC-7913	733 FWD (TRACTORS) CASE D-206		Hydraulic Oil Filter Transmission...	H-65030
684 (AGRICULTURE) CASE D-239		Hydraulic Oil Filter.....	H-5408	80 CRUZ-AIR (CONSTRUCTION EQUIPMENTS)	
Hydraulic Oil Filter.....	H-5410	Hydraulic Oil Filter.....	H-5409	Hydraulic Oil Filter.....	H-57030
Hydraulic Oil Filter.....	H-7999	740 (TRACTORS) CASE A251		815 (COMBINES) CASE	
Hydraulic Oil Filter.....	H-5410	Hydraulic Oil Filter.....	H-5408	Hydraulic Oil Filter.....	H-5405
685XL (TRACTORS) CASE D-239		743 (TRACTORS) CASE D-239		815 (COMBINES) IHC D407	
Hydraulic Oil Filter.....	H-5410	Hydraulic Oil Filter.....	H-5408	Hydraulic Oil Filter.....	H-5405
688 (EXCAVATORS) CASE 4T-390 , 1991		Hydraulic Oil Filter.....	H-5409	815 (COMBINES) IHC DT407	
Hydraulic Oil Filter.....	HC-5506	750H (TRACTORS)		Hydraulic Oil Filter.....	H-5405
695 (AGRICULTURE) 695		Hydraulic Oil Filter.....	HC-5508	815 (COMBINES) IHC DT414	
Hydraulic Oil Filter.....	H-7999	75C (EXCAVATORS)		Hydraulic Oil Filter.....	H-5405
7110 (TRACTORS)		Hydraulic Oil Filter.....	H-71140	Hydraulic Oil Filter.....	H-5405
Hydraulic Oil Filter.....	HC-5508	Hydraulic Oil Filter.....	H-85110	815 (COMBINES) IHC D-414	
7120 (TRACTORS) CONSOLDI 8.3L		75XT (SKIDDERS) CASE 4-390		Hydraulic Oil Filter.....	H-5405
Hydraulic Oil Filter.....	HC-5508	Hydraulic Oil Filter.....	HC-5508	821 (CONSTRUCTION & MINING) CASE 6T8.3 , 1991	
7130 (TRACTORS) CASE 6T830		760 (TRENCHERS)		Hydraulic Oil Filter Transmission...	HC-2701
Hydraulic Oil Filter.....	HC-5508	Hydraulic Oil Filter.....	HC-7972	Hydraulic Oil Filter.....	HC-5508
7130 (TRACTORS) CASE 6TA-830		780B (BACKHOE LOADERS)		Hydraulic Oil Filter Transmission...	HC-2701
Hydraulic Oil Filter.....	HC-5508	Hydraulic Oil Filter.....	HC-7913	821B (CONSTRUCTION & MINING) CASE 6T8.3 , 1991	
721 (CONSTRUCTION & MINING)		780C (LOADERS)		Hydraulic Oil Filter Transmission...	HC-2701
Hydraulic Oil Filter Transmission...	HC-2701	Hydraulic Oil Filter.....	HC-7913	821B (LOADERS)	
Hydraulic Oil Filter Transmission...	HC-2701	780CK (BACKHOE LOADERS)		Hydraulic Oil Filter.....	HC-5508
Hydraulic Oil Filter.....	HC-5508	Hydraulic Oil Filter Transmission....	H-5109	Hydraulic Oil Filter Transmission...	HC-2701
7210 MAGNUM (TRACTORS)		780D (BACKHOE LOADERS)		821C (LOADERS)	
Hydraulic Oil Filter.....	HC-5508	Hydraulic Oil Filter.....	HC-7913	Hydraulic Oil Filter Transmission...	HC-76130
				Hydraulic Oil Filter.....	HC-5508



ENGINE APPLICATION

MODEL/APPLICATION	SAKURA NO	MODEL/APPLICATION	SAKURA NO	MODEL/APPLICATION	SAKURA NO
CASE		CASE		CASE	
821 E (LOADERS) CASE 667TA/EED , 2007		880 CRAWLER (EXCAVATORS) CASE (S/N: TO-10093005)		Hydraulic Oil Filter.....	H-2719
Hydraulic Oil Filter Transmission..	HC-76130	Hydraulic Oil Filter.....	H-79411	Hydraulic Oil Filter.....	H-2718
Hydraulic Oil Filter.....	HC-5504			Hydraulic Oil Filter.....	H-5513
824 (AGRICULTURE) 824		880B CRAWLER (EXCAVATORS)		9013 (CONSTRUCTION & MINING) L4 4.3L 4326cc 264 CID , 4300	
Hydraulic Oil Filter.....	H-5409	Hydraulic Oil Filter.....	H-79411	Hydraulic Oil Filter.....	H-5519
824 (TRACTORS)		880C CRAWLER (EXCAVATORS)		9013 ALLIANCE (EXCAVATORS)	
Hydraulic Oil Filter.....	H-5409	Hydraulic Oil Filter.....	H-79411	Hydraulic Oil Filter.....	H-2719
833 (TRACTORS)		880R WHEEL (EXCAVATORS)		9020 (EXCAVATORS)	
Hydraulic Oil Filter.....	H-5409	Hydraulic Oil Filter.....	H-79411	Hydraulic Oil Filter.....	H-2718
833N (TRACTORS) CASE D-239		884 (AGRICULTURE) CASE D-246		Hydraulic Oil Filter.....	H-2719
Hydraulic Oil Filter.....	H-5408	Hydraulic Oil Filter.....	H-5410	Hydraulic Oil Filter.....	H-5513
840 (TRACTORS)		884 (AGRICULTURE) CASE D-268		9021 (EXCAVATORS)	
Hydraulic Oil Filter.....	H-5408	Hydraulic Oil Filter.....	H-7999	Hydraulic Oil Filter.....	H-2719
844 (TRACTORS)		884 (TRACTORS) CASE D-246		9020B (EXCAVATORS)	
Hydraulic Oil Filter.....	H-5409	Hydraulic Oil Filter.....	H-5410	Hydraulic Oil Filter.....	H-2719
Hydraulic Oil Filter.....	H-5408	8840 (AGRICULTURE) CASE 4T-390		Hydraulic Oil Filter.....	H-5513
845XLA (TRACTORS)		Hydraulic Oil Filter.....	HC-5511	9030 (EXCAVATORS)	
Hydraulic Oil Filter.....	H-5409	885 (AGRICULTURE) 885		Hydraulic Oil Filter.....	H-2719
845XL FWD (TRACTORS) CASE D-268		Hydraulic Oil Filter.....	H-7999	9033 (EXCAVATORS)	
Hydraulic Oil Filter.....	H-5408	Hydraulic Oil Filter.....	H-5410	Hydraulic Oil Filter.....	H-2719
850D (DOZERS)		8910 (TRACTORS) 1998-UP		9030B (EXCAVATORS)	
Hydraulic Oil Filter.....	HC-5508	Hydraulic Oil Filter.....	HC-5508	Hydraulic Oil Filter.....	H-2719
850E (LOADERS)		895 (AGRICULTURE) 895		9040 (EXCAVATORS)	
Hydraulic Oil Filter.....	HC-5508	Hydraulic Oil Filter.....	H-7999	Hydraulic Oil Filter.....	H-2719
850G (CRAWLERS) CASE 6T590		9007 (EXCAVATORS)		9046 (EXCAVATORS) MITSUBISI 6D24-TCE1	
Hydraulic Oil Filter.....	HC-5508	Hydraulic Oil Filter.....	H-2719	Hydraulic Oil Filter.....	H-5513
850H (LOADERS)		9007B (EXCAVATORS) ISUZU 4JA1		Hydraulic Oil Filter.....	H-2718
Hydraulic Oil Filter.....	HC-5508	Hydraulic Oil Filter.....	H-2719	Hydraulic Oil Filter.....	H-2719
856XL TURBO (TRACTORS) CASE DT-239 TURBO		9007 CK (EXCAVATORS)		9040B (EXCAVATORS)	
Hydraulic Oil Filter.....	H-5409	Hydraulic Oil Filter.....	H-2719	Hydraulic Oil Filter.....	H-2719
85CKB (EXCAVATORS)		9010 (EXCAVATORS)		9050 (EXCAVATORS)	
Hydraulic Oil Filter.....	H-71140	Hydraulic Oil Filter.....	H-5513	Hydraulic Oil Filter.....	H-2719
Hydraulic Oil Filter.....	H-85110	Hydraulic Oil Filter.....	H-2718	9050B (EXCAVATORS) S/N: EAC0501122-UP	
880 CRAWLER (EXCAVATORS) CASE (S/N: 10093006-UP)		Hydraulic Oil Filter.....	H-2719	Hydraulic Oil Filter.....	H-2719
Hydraulic Oil Filter.....	H-79411	9010B (EXCAVATORS)		90XT (SKIDDERS)	
		Hydraulic Oil Filter.....	HC-5508	Hydraulic Oil Filter.....	HC-5508



ENGINE APPLICATION

MODEL/APPLICATION	SAKURA NO	MODEL/APPLICATION	SAKURA NO	MODEL/APPLICATION	SAKURA NO
CASE		CASE		CASE	
9110 (TRACTORS) CONSOLDI 8.3L (S/N: JCB0003600-UP) Hydraulic Oil Filter.....	HC-5508	9250 (TRACTORS) Hydraulic Oil Filter.....	HC-5508	995 (AGRICULTURE) 995 Hydraulic Oil Filter.....	H-7999
9110 (TRACTORS) CONSOLDI 8.3L (S/N: TO-JCB0003599) Hydraulic Oil Filter.....	HC-5508	9270 (TRACTORS) Hydraulic Oil Filter.....	HC-5508	AFX8010 (COMBINES) Hydraulic Oil Filter.....	HC-5508
915 (COMBINES) CASE W/V-392 Hydraulic Oil Filter.....	H-5405	9330 (TRACTORS) CUMMINS 6CTA8.3 Hydraulic Oil Filter.....	HC-5508	Hydraulic Oil Filter.....	HC-76080
9150 (TRACTORS) CAT 3306 (S/N: TO-JCB0003599) Hydraulic Oil Filter.....	HC-5508	9350 (TRACTORS) CUMMINS LTA10 Hydraulic Oil Filter.....	HC-5508	BEARCAT 1000 POWER SHIFT (TRACTORS) CUMMINS Hydraulic Oil Filter.....	HC-5508
9150 (TRACTORS) CUMMINS (S/N: TO-JCB0003599) Hydraulic Oil Filter.....	HC-5508	9370 (TRACTORS) CUMMINS NTA-855 Hydraulic Oil Filter.....	HC-5508	BEARCAT 1000 POWER SHIFT (TRACTORS) Hydraulic Oil Filter.....	HC-5508
9150 (TRACTORS) S/N: JCB0003600-UP Hydraulic Oil Filter.....	HC-5508	9390 (TRACTORS) Hydraulic Oil Filter.....	HC-5508	CA, CU INDUSTRIAL SERIES (TRACTORS) CUMMINS Hydraulic Oil Filter Transmission... Hydraulic Oil Filter.....	H-65030 H-51170
9170 (TRACTORS) CAT 3406 (S/N: TO-JCB0003599) Hydraulic Oil Filter..... Hydraulic Oil Filter.....	HC-5508 H-51170	940 (TRACTORS) CASE A377 Hydraulic Oil Filter.....	H-5408	CA, CU INDUSTRIAL SERIES (TRACTORS) Hydraulic Oil Filter Transmission... Hydraulic Oil Filter.....	H-65030 H-51170
9170 (TRACTORS) CUMMINS (S/N: TO-JCB0003599) Hydraulic Oil Filter..... Hydraulic Oil Filter.....	H-51170 HC-5508	940 (TRACTORS) CASE A401 Hydraulic Oil Filter.....	H-5408	CK36 (EXCAVATORS) 1992 Hydraulic Oil Filter.....	H-7956
9170 (TRACTORS) S/N: JCB0003600-UP Hydraulic Oil Filter.....	HC-5508	95 (HARVESTERS) CASE Hydraulic Oil Filter.....	H-5405	CK50 (EXCAVATORS) 1992 Hydraulic Oil Filter.....	H-7956
9190 (TRACTORS) CUMMINS Hydraulic Oil Filter..... Hydraulic Oil Filter Transmission...	HC-5511 H-65030	955 (TRACTORS) Hydraulic Oil Filter..... Hydraulic Oil Filter.....	H-5408 H-5409	CK62 (EXCAVATORS) KUBOTA S2800D , 1992 Hydraulic Oil Filter.....	HC-5602
921 (LOADERS) Hydraulic Oil Filter.....	HC-5506	955C (LOADERS) Hydraulic Oil Filter.....	HC-5508	COUGAR 1000 POWER SHIFT (TRACTORS) CUMMINS Hydraulic Oil Filter.....	HC-5508
9210 (TRACTORS) Hydraulic Oil Filter.....	HC-5508	960 (TRENCHERS) Hydraulic Oil Filter.....	HC-57020	COUGAR 1000 POWER SHIFT (TRACTORS) Hydraulic Oil Filter.....	HC-5508
921B (LOADERS) Hydraulic Oil Filter.....	HC-5506	980 (EXCAVATORS) Hydraulic Oil Filter.....	H-79411	CS240 (EXCAVATORS) CASE Hydraulic Oil Filter..... Hydraulic Oil Filter..... Hydraulic Oil Filter.....	H-2718 H-5513 H-2719
921C (LOADERS) Hydraulic Oil Filter Transmission... Hydraulic Oil Filter.....	HC-76130 HC-5506	980D (EXCAVATORS) Hydraulic Oil Filter.....	H-79411	CS280 IV (TRACTORS) Hydraulic Oil Filter Transmission... Hydraulic Oil Filter.....	H-65030 H-2719
921E (LOADERS) CUMMINS QSM11 (S/N: TIER 3-UP) , 2007 Hydraulic Oil Filter Transmission... Hydraulic Oil Filter.....	HC-76130 HC-5512	988 (SHOVELS) Hydraulic Oil Filter..... Hydraulic Oil Filter.....	HC-5506 H-5107	CS800 (EXCAVATORS) Hydraulic Oil Filter..... Hydraulic Oil Filter..... Hydraulic Oil Filter.....	H-2719 H-2718 H-5513
		988P (LOADERS) Hydraulic Oil Filter..... Hydraulic Oil Filter.....	HC-5506 H-5107	CTX500 (TRACTORS) Hydraulic Oil Filter.....	HC-5508



ENGINE APPLICATION

MODEL/APPLICATION	SAKURA NO	MODEL/APPLICATION	SAKURA NO	MODEL/APPLICATION	SAKURA NO
CASE		CASE		CASE	
CVT6135 (TRACTORS) 2003-UP Hydraulic Oil Filter.....	HC-5504	DX21 (TRACTORS) Hydraulic Oil Filter.....	HC-5816	Hydraulic Oil Filter.....	HC-5504
CVT6140 (TRACTORS) 2007-UP Hydraulic Oil Filter.....	HC-5504	DX29 (TRACTORS) Hydraulic Oil Filter.....	HC-5816	MX240 (TRACTORS) Hydraulic Oil Filter.....	HC-76080
CVX130 (TRACTORS) STEYRDAI WD620.89 , 1999-UP Hydraulic Oil Filter.....	HC-5504	HYDRO 84 (TRACTORS) CASE D-246 Hydraulic Oil Filter.....	H-5410	Hydraulic Oil Filter.....	HC-1905
CVX150 (TRACTORS) STEYRDAI WD620.89 , 1999-UP Hydraulic Oil Filter.....	HC-5504	JX1075C (TRACTORS) Hydraulic Oil Filter.....	H-5107	Hydraulic Oil Filter.....	HC-5504
CX130 (CONSTRUCTION & MINING) L4 3.9L 3916cc 239 CID , 3900 Hydraulic Oil Filter.....	H-5519	JX1060C (TRACTORS) CASE IH Hydraulic Oil Filter.....	H-5107	MXM120 (TRACTORS) Hydraulic Oil Filter.....	HC-1905
CX130 (EXCAVATORS) 2004-UP Hydraulic Oil Filter.....	H-5513	JX1080U (TRACTORS) Hydraulic Oil Filter.....	H-5107	Hydraulic Oil Filter.....	HC-1905
Hydraulic Oil Filter.....	H-2718	JX1090U (TRACTORS) Hydraulic Oil Filter.....	H-5107	MXU100 (TRACTORS) Hydraulic Oil Filter.....	HC-1905
Hydraulic Oil Filter.....	H-2719	JX1100U (TRACTORS) Hydraulic Oil Filter.....	H-5107	MXU110 (TRACTORS) Hydraulic Oil Filter.....	HC-1905
CX160 (CONSTRUCTION & MINING) L4 3.9L 3916cc 239 CID , 3900 Hydraulic Oil Filter.....	H-5519	JX55 (TRACTORS) Hydraulic Oil Filter.....	HC-45110	MXU115 (TRACTORS) Hydraulic Oil Filter.....	HC-5504
CX160 (EXCAVATORS) Hydraulic Oil Filter.....	H-2719	JX70U (TRACTORS) IVECO 8045.05 Hydraulic Oil Filter.....	H-5107	Hydraulic Oil Filter.....	HC-1905
Hydraulic Oil Filter.....	H-2718	JX70U (TRACTORS) IVECO 8045.06 Hydraulic Oil Filter.....	H-5107	P61 (LOADERS) DEUTZ F4L912 Hydraulic Oil Filter.....	HC-1822
Hydraulic Oil Filter.....	H-5513	JX90U (TRACTORS) IVECO 8045.25 Hydraulic Oil Filter.....	H-5107	PANTHER 1000 SERIES (TRACTORS) CUMMINS Hydraulic Oil Filter.....	H-51170
CX135SR (EXCAVATORS) ISUZU , 2002-UP Hydraulic Oil Filter.....	H-2718	JX95 (TRACTORS) Hydraulic Oil Filter.....	HC-45110	Hydraulic Oil Filter Transmission...	H-65030
Hydraulic Oil Filter.....	H-5513	KP525 IV (TRACTORS) Hydraulic Oil Filter Transmission...	H-65030	PANTHER 1000 SERIES (TRACTORS) Hydraulic Oil Filter Transmission...	H-65030
CX210 (EXCAVATORS) Hydraulic Oil Filter.....	H-2719	KS280 IV (TRACTORS) Hydraulic Oil Filter Transmission...	H-65030	Hydraulic Oil Filter.....	H-51170
CX290 (EXCAVATORS) Hydraulic Oil Filter.....	H-2719	MAXI-SNEAKER C (TRENCHERS) Hydraulic Oil Filter.....	HC-57020	PANTHER/LION 1000 POWER SHIFT (TRACTORS) CAT 3406 Hydraulic Oil Filter.....	HC-5508
CX330 (EXCAVATORS) 2002-UP Hydraulic Oil Filter.....	H-2719	MX180 MAGNUM (TRACTORS) CUMMINS 6C8.3 Hydraulic Oil Filter.....	HC-76080	Hydraulic Oil Filter.....	H-51170
CX47 (CONSTRUCTION & MINING) L4 2.2L 2188cc 133.5 CID , 2200 Hydraulic Oil Filter.....	H-5519			PANTHER/LION 1000 POWER SHIFT (TRACTORS) CUMMINS NT-855 Hydraulic Oil Filter.....	H-51170
D25 (TRACTORS) Hydraulic Oil Filter.....	HC-5816			Hydraulic Oil Filter.....	HC-5508
DH4 (TRENCHERS) CASE 2.1 L Hydraulic Oil Filter.....	HC-5508			PT225 III (TRACTORS) Hydraulic Oil Filter.....	H-51170
				Hydraulic Oil Filter.....	H-51170
				PT270 III (TRACTORS) Hydraulic Oil Filter.....	H-51170
				Hydraulic Oil Filter.....	H-51170
				PT350 III (TRACTORS) Hydraulic Oil Filter.....	H-51170
				PTA251 III (TRACTORS)	



ENGINE APPLICATION

MODEL/APPLICATION	SAKURA NO	MODEL/APPLICATION	SAKURA NO	MODEL/APPLICATION	SAKURA NO
CASE		CASE		CASE - IH	
PTA251 III (TRACTORS) Hydraulic Oil Filter Transmission... H-65030		W14 (LOADERS) S/N: 9119672-UP Hydraulic Oil Filter Full Flow..... HC-79331		Hydraulic Oil Filter..... H-76050 CVX-Serie (AGRICULTURE) 195 SISU 6.6L , 2007-2009 Hydraulic Oil Filter..... H-45050	
PTA270 III (TRACTORS) Hydraulic Oil Filter Transmission... H-65030		W14B (LOADERS) Hydraulic Oil Filter..... HC-5506 Hydraulic Oil Filter..... HC-7913		CVX-Serie (AGRICULTURE) 140 , 2007 Hydraulic Oil Filter..... H-45050	
PTA280 III (TRACTORS) CUMMINS Hydraulic Oil Filter Transmission... H-65030		W18 (LOADERS) S/N: 9123140-UP Hydraulic Oil Filter Full Flow..... HC-79331		CVX-Serie (AGRICULTURE) 150 , 2007 Hydraulic Oil Filter..... H-45050	
PTA280 III (TRACTORS) Hydraulic Oil Filter Transmission... H-65030		W18 (LOADERS) S/N: TO-9123139 Hydraulic Oil Filter Transmission... H-65030		CVX-Serie (AGRICULTURE) 160 , 2007 Hydraulic Oil Filter..... H-45050	
PTA296 III (TRACTORS) Hydraulic Oil Filter Transmission... H-65030		W18B (LOADERS) Hydraulic Oil Filter Full Flow..... HC-79331		CVX-Serie (AGRICULTURE) 175 , 2007 Hydraulic Oil Filter..... H-45050	
PTA325 III (TRACTORS) Hydraulic Oil Filter Transmission... H-65030		W20 (LOADERS) Hydraulic Oil Filter Transmission... H-65030		CASE STEYR	
PUMA 1000 POWER SHIFT (TRACTORS) Hydraulic Oil Filter..... HC-5508		W20 (LOADERS) S/N: 9123140-UP Hydraulic Oil Filter Full Flow..... HC-79331		CVT-Serie (AGRICULTURE) 615 , 2007 Hydraulic Oil Filter..... H-45050	
QUADTRAC (TRACTORS) Hydraulic Oil Filter..... HC-5508		W20B (LOADERS) S/N: 9123140-UP Hydraulic Oil Filter Full Flow..... HC-79331		CVT-Serie (AGRICULTURE) 6160 , 2007 Hydraulic Oil Filter..... H-45050	
ST450 III (TRACTORS) CUMMINS Hydraulic Oil Filter Transmission... H-65030		W20C (LOADERS) Hydraulic Oil Filter Full Flow..... HC-79331		CVT-Serie (AGRICULTURE) 6175 , 2007 Hydraulic Oil Filter..... H-45050	
ST450 III (TRACTORS) Hydraulic Oil Filter Transmission... H-65030		W24C (LOADERS) Hydraulic Oil Filter Full Flow..... HC-79331		CVT-Serie (AGRICULTURE) 6195 , 2007 Hydraulic Oil Filter..... H-45050	
ST470 III (TRACTORS) Hydraulic Oil Filter Transmission... H-65030		W30 (LOADERS) Hydraulic Oil Filter Full Flow..... HC-79331		CVT-Serie (AGRICULTURE) 6195 C , 2007 Hydraulic Oil Filter..... H-45050	
STX275 (TRACTORS) Hydraulic Oil Filter..... HC-5508		W36 (LOADERS) S/N: 17754000-UP Hydraulic Oil Filter Full Flow..... HC-79331 Hydraulic Oil Filter Transmission.... H-5109		CATERPILLAR	
STX375 (TRACTORS) Hydraulic Oil Filter..... HC-5508		W36 (LOADERS) S/N: TO-17753999 Hydraulic Oil Filter Full Flow..... HC-79331 Hydraulic Oil Filter Transmission.... H-5109		1090 (FELLER BUNCHERS) Hydraulic Oil Filter..... HC-5801 Hydraulic Oil Filter..... HC-55170	
STX500 (TRACTORS) Hydraulic Oil Filter..... HC-5508		WDX1701 (TRACTORS) Hydraulic Oil Filter..... HC-5511		112E (GRADERS) S/N: 72H,91G-UP Hydraulic Oil Filter..... H-5508	
W11 (LOADERS) CASE 207 Hydraulic Oil Filter..... HC-5511		WDX901 (TRACTORS) Hydraulic Oil Filter..... HC-5511		112F (GRADERS) S/N: 7KK1-UP Hydraulic Oil Filter..... H-5503	
W11B (LOADERS) CUMMINS 4B3.9 Hydraulic Oil Filter..... HC-5511		CASE - IH		120 (GRADERS) S/N: 13U1-681 Hydraulic Oil Filter..... H-5504	
W14 (LOADERS) Hydraulic Oil Filter Full Flow..... HC-79331		7700 (HARVESTERS) CUMMINS QSM11		120 (GRADERS) S/N: 13U942-UP Hydraulic Oil Filter..... H-5504	
				120H (GRADERS) CAT 3126B (S/N: 2AN1-UP)	



ENGINE APPLICATION

MODEL/APPLICATION	SAKURA NO	MODEL/APPLICATION	SAKURA NO	MODEL/APPLICATION	SAKURA NO
CATERPILLAR		CATERPILLAR		CATERPILLAR	
120H (GRADERS) CAT 3126B (S/N: 2AN1-UP)		120G (GRADERS) S/N: 82V1-UP		12H (GRADERS) S/N: 2GS1-UP	
Hydraulic Oil Filter.....	H-5504	Hydraulic Oil Filter.....	H-5504	Hydraulic Oil Filter.....	H-55270
Hydraulic Oil Filter.....	H-5506			Hydraulic Oil Filter.....	H-5506
120H (GRADERS) CAT 3126B (S/N: 4MK1-UP)		120G (GRADERS) S/N: 87V1-UP		12H (GRADERS) S/N: 2LR1-UP	
Hydraulic Oil Filter.....	H-5504	Hydraulic Oil Filter.....	H-5504	Hydraulic Oil Filter.....	H-5504
Hydraulic Oil Filter.....	H-55270			Hydraulic Oil Filter.....	H-55270
Hydraulic Oil Filter.....	H-5506	120G (GRADERS) S/N: 87V8319-8359		Hydraulic Oil Filter.....	H-5506
		Hydraulic Oil Filter.....	H-55270		
120H (GRADERS) S/N: 5FM1-UP		Hydraulic Oil Filter.....	H-5504	12H (GRADERS) S/N: 2WR1-UP	
Hydraulic Oil Filter.....	H-5506			Hydraulic Oil Filter.....	H-5506
Hydraulic Oil Filter.....	H-55270	120G (GRADERS) S/N: 87V8360-UP		Hydraulic Oil Filter.....	H-5504
		Hydraulic Oil Filter.....	H-5504	Hydraulic Oil Filter.....	H-55270
120H (GRADERS) S/N: 6NM1-UP		Hydraulic Oil Filter.....	H-55270	12H (GRADERS) S/N: 4ER1-UP	
Hydraulic Oil Filter.....	H-5506	120G (MOTOR GRADERS) w/3304 Eng.		Hydraulic Oil Filter.....	H-55270
Hydraulic Oil Filter.....	H-5504	Hydraulic Oil Filter.....	H-55320	Hydraulic Oil Filter.....	H-5506
Hydraulic Oil Filter.....	H-55270			12H (GRADERS) S/N: 4XM1-UP	
120H (GRADERS) S/N: 6TM1-UP		120HES (GRADERS)		Hydraulic Oil Filter.....	H-5504
Hydraulic Oil Filter.....	H-55270	Hydraulic Oil Filter.....	H-55270	Hydraulic Oil Filter.....	H-5506
Hydraulic Oil Filter.....	H-5504			Hydraulic Oil Filter.....	H-55270
Hydraulic Oil Filter.....	H-5506	120E (GRADERS)			
		Hydraulic Oil Filter.....	H-5504	12H (GRADERS) S/N: 5ZM1-UP	
120H (GRADERS) S/N: 6YN1-UP		12F (GRADERS) S/N: 73G1-UP		Hydraulic Oil Filter.....	H-5504
Hydraulic Oil Filter.....	H-5506	Hydraulic Oil Filter.....	H-5508	Hydraulic Oil Filter.....	H-55270
Hydraulic Oil Filter.....	H-55270			Hydraulic Oil Filter.....	H-5506
Hydraulic Oil Filter.....	H-5506	12F (GRADERS) S/N: 89H1-1224		12H (GRADERS) S/N: 8MN1-UP	
		Hydraulic Oil Filter.....	H-5504	Hydraulic Oil Filter.....	H-5506
120H (GRADERS) S/N: 9YR1-UP		Hydraulic Oil Filter.....	H-5508	Hydraulic Oil Filter.....	H-55270
Hydraulic Oil Filter.....	H-55270				
Hydraulic Oil Filter.....	H-5506	12F (GRADERS) S/N: 89H1225-UP		12HNA (GRADERS)	
		Hydraulic Oil Filter.....	H-5508	Hydraulic Oil Filter.....	H-5504
120H (GRADERS) S/N: ALZ1-UP		Hydraulic Oil Filter.....	H-5504	Hydraulic Oil Filter.....	H-5506
Hydraulic Oil Filter.....	H-5506			Hydraulic Oil Filter.....	H-55270
		12G (GRADERS) CAT 3306			
120H (GRADERS) S/N: CAF1-UP		Hydraulic Oil Filter.....	H-5504	130G (GRADERS) CAT 3304 (S/N: 12W1-UP)	
Hydraulic Oil Filter.....	H-5506	Hydraulic Oil Filter.....	H-55270	Hydraulic Oil Filter.....	H-5504
120G (GRADERS) S/N: 11W1251-UP		12G (GRADERS) CAT 3306 (S/N: 3PL1-UP)		Hydraulic Oil Filter.....	H-5504
Hydraulic Oil Filter.....	H-5504	Hydraulic Oil Filter.....	H-5504		
Hydraulic Oil Filter.....	H-55270			130G (GRADERS) CAT 3304 (S/N: 74V1-UP)	
		12G (GRADERS) CAT 3306 (S/N: 3WC1067-UP)		Hydraulic Oil Filter.....	H-5504
120G (GRADERS) S/N: 4HD1-702		Hydraulic Oil Filter.....	H-5504		
Hydraulic Oil Filter.....	H-55270			130G (GRADERS) S/N: 7GB1224-UP	
Hydraulic Oil Filter.....	H-5504	12G (GRADERS) CAT 3306 (S/N: 61M1-UP)		Hydraulic Oil Filter.....	H-5504
		Hydraulic Oil Filter.....	H-5504	Hydraulic Oil Filter.....	H-55270
120G (GRADERS) S/N: 4HD1-UP					
Hydraulic Oil Filter.....	H-5504	12G (GRADERS) S/N: 3WC1-1066		130G (MOTOR GRADERS) w/3304 Eng.	
Hydraulic Oil Filter.....	H-55270	Hydraulic Oil Filter.....	H-5504	Hydraulic Oil Filter.....	H-55320
120G (GRADERS) S/N: 4HD703-UP		12G (GRADERS) CAT 3306 (S/N: 61M1-UP)		135H (GRADERS) CAT 3116T VHP (S/N: 3YK1-UP)	
Hydraulic Oil Filter.....	H-55270	Hydraulic Oil Filter.....	H-5504	Hydraulic Oil Filter.....	H-5506
Hydraulic Oil Filter.....	H-5504				



ENGINE APPLICATION

MODEL/APPLICATION	SAKURA NO
CATERPILLAR	
135H (GRADERS) CAT 3116T VHP (S/N: 3YK1-UP)	
Hydraulic Oil Filter.....	H-5504
Hydraulic Oil Filter.....	H-55270
135H (GRADERS) CAT 3116T VHP (S/N: 7MM1-UP)	
Hydraulic Oil Filter.....	H-5506
Hydraulic Oil Filter.....	H-5504
Hydraulic Oil Filter.....	H-55270
135H (GRADERS) CAT 3116T VHP (S/N: 8WN1-UP)	
Hydraulic Oil Filter.....	H-5506
140 (GRADERS) S/N: 14U1-387	
Hydraulic Oil Filter.....	H-5504
140 (GRADERS) S/N: 14U388-UP	
Hydraulic Oil Filter.....	H-5504
140 (GRADERS) S/N: 72V-UP	
Hydraulic Oil Filter.....	H-5504
140 (HYDRAULIC SYSTEMS) S/N: 22J1-UP	
Hydraulic Oil Filter.....	H-5508
140 (HYDRAULIC SYSTEMS) S/N: 36X1-UP	
Hydraulic Oil Filter.....	H-5508
Hydraulic Oil Filter.....	H-5504
140H (GRADERS) CAT 3306 (S/N: 2ZK1-200)	
Hydraulic Oil Filter.....	H-5506
Hydraulic Oil Filter.....	H-5504
140H (GRADERS)	
Hydraulic Oil Filter.....	H-5506
Hydraulic Oil Filter.....	H-5504
Hydraulic Oil Filter.....	H-55270
140H (GRADERS) S/N: 2ZK201-UP	
Hydraulic Oil Filter.....	H-5504
Hydraulic Oil Filter.....	H-5506
140H (GRADERS) S/N: 3AS00491-UP	
Hydraulic Oil Filter.....	H-5506
Hydraulic Oil Filter.....	H-5504
140H (GRADERS) S/N: 3AS1-UP	
Hydraulic Oil Filter.....	H-5506
Hydraulic Oil Filter.....	H-55270
140H (GRADERS) S/N: 5HM1-UP	
Hydraulic Oil Filter.....	H-55270

MODEL/APPLICATION	SAKURA NO
CATERPILLAR	
Hydraulic Oil Filter.....	H-5506
140H (GRADERS) S/N: 8JM1-UP	
Hydraulic Oil Filter.....	H-55270
Hydraulic Oil Filter.....	H-5506
Hydraulic Oil Filter.....	H-5504
140H (GRADERS) S/N: 8KM1-UP	
Hydraulic Oil Filter.....	H-55270
Hydraulic Oil Filter.....	H-5504
Hydraulic Oil Filter.....	H-5506
140H (GRADERS) S/N: 9TN1-UP	
Hydraulic Oil Filter.....	H-5506
Hydraulic Oil Filter.....	H-55270
140H (GRADERS) S/N: 9ZN1-UP	
Hydraulic Oil Filter.....	H-55270
Hydraulic Oil Filter.....	H-5506
Hydraulic Oil Filter.....	H-5504
140G (GRADERS) CAT 3306 (S/N: 5MD1-UP)	
Hydraulic Oil Filter.....	H-5504
Hydraulic Oil Filter.....	HC-5503
Hydraulic Oil Filter.....	HC-5506
140G (GRADERS) CAT 3306 (S/N: 72V1-UP)	
Hydraulic Oil Filter.....	HC-5506
Hydraulic Oil Filter.....	HC-5503
Hydraulic Oil Filter.....	H-5504
140G (GRADERS) CAT 3306 (S/N: 81V1-UP)	
Hydraulic Oil Filter.....	H-5504
Hydraulic Oil Filter.....	HC-5503
Hydraulic Oil Filter.....	HC-5506
140G (GRADERS) S/N: 72V02537-UP	
Hydraulic Oil Filter.....	H-5504
140G (MOTOR GRADERS) w/3306 Eng.	
Hydraulic Oil Filter.....	H-55320
141 (HYDRAULIC SYSTEMS) S/N: 54G1-UP	
Hydraulic Oil Filter.....	H-5508
141 (HYDRAULIC SYSTEMS) S/N: 62G7001-UP	
Hydraulic Oil Filter.....	H-5508
143H (GRADERS) CAT 3176C ATAAC VHP	
Hydraulic Oil Filter.....	H-5506
Hydraulic Oil Filter.....	H-5504
Hydraulic Oil Filter.....	HC-5504
Hydraulic Oil Filter.....	HC-5508

MODEL/APPLICATION	SAKURA NO
CATERPILLAR	
143H (GRADERS) CAT 3176C ATAAC VHP (S/N: 1A11-UP)	
Hydraulic Oil Filter.....	H-5506
Hydraulic Oil Filter.....	H-55270
Hydraulic Oil Filter.....	H-5504
Hydraulic Oil Filter.....	HC-5504
143 (HYDRAULIC SYSTEMS) S/N: 36X1-UP	
Hydraulic Oil Filter.....	H-5504
14E (GRADERS) S/N: 12K1-1835	
Hydraulic Oil Filter.....	H-5508
14E (GRADERS) S/N: 12K1836-UP	
Hydraulic Oil Filter.....	H-5508
14E (GRADERS) S/N: 72G1030-UP	
Hydraulic Oil Filter.....	H-5504
14E (GRADERS) S/N: 72G1-1029	
Hydraulic Oil Filter.....	H-5504
14G (GRADERS) CAT 3306 (S/N: 96U1-UP)	
Hydraulic Oil Filter.....	H-5504
14H (GRADERS) CAT 3176C ATAAC (S/N: 7WJ1-UP)	
Hydraulic Oil Filter.....	H-55270
Hydraulic Oil Filter.....	H-5506
Hydraulic Oil Filter.....	H-5504
14H (GRADERS) CAT 3176C ATAAC VHP (S/N: 7WJ1-UP)	
Hydraulic Oil Filter.....	H-5504
Hydraulic Oil Filter.....	H-55270
Hydraulic Oil Filter.....	H-5506
14H (GRADERS)	
Hydraulic Oil Filter.....	H-5506
Hydraulic Oil Filter.....	H-55270
14H (GRADERS) S/N: 7WJ1-10	
Hydraulic Oil Filter.....	H-5506
Hydraulic Oil Filter.....	H-5504
14H (GRADERS) S/N: 7WJ11-UP	
Hydraulic Oil Filter.....	H-5504
Hydraulic Oil Filter.....	H-5506
14H NA (GRADERS)	
Hydraulic Oil Filter.....	H-55270
Hydraulic Oil Filter.....	H-5504
Hydraulic Oil Filter.....	H-5506



ENGINE APPLICATION

MODEL/APPLICATION	SAKURA NO	MODEL/APPLICATION	SAKURA NO	MODEL/APPLICATION	SAKURA NO
CATERPILLAR		CATERPILLAR		CATERPILLAR	
14M (GRADERS) S/N: B9J1-UP		160H ES (GRADERS)		163 (HYDRAULIC SYSTEMS) S/N: 39F1-39F7849	
Hydraulic Oil Filter.....	HC-5504	Hydraulic Oil Filter.....	H-5506	Hydraulic Oil Filter.....	H-5504
151 (HYDRAULIC SYSTEMS) S/N: 62G1-UP		Hydraulic Oil Filter.....	H-5504	Hydraulic Oil Filter.....	H-5503
Hydraulic Oil Filter.....	H-5508	Hydraulic Oil Filter.....	H-55270	163 (HYDRAULIC SYSTEMS) S/N: 39G1-UP	
153 (HYDRAULIC SYSTEMS) S/N: 38G1-UP		16 (GRADERS) S/N: 49G1-UP		Hydraulic Oil Filter.....	H-5508
Hydraulic Oil Filter.....	H-5508	Hydraulic Oil Filter.....	H-5504	163 (HYDRAULIC SYSTEMS) S/N: 41F1-41F234	
153 (HYDRAULIC SYSTEMS) S/N: 39G1-UP		Hydraulic Oil Filter.....	H-5508	Hydraulic Oil Filter.....	H-5504
Hydraulic Oil Filter.....	H-5508	16 (GRADERS) S/N: 93U1-3459		Hydraulic Oil Filter.....	H-5503
153 (HYDRAULIC SYSTEMS) S/N: 44G1-UP		Hydraulic Oil Filter.....	H-5504	163 (HYDRAULIC SYSTEMS) S/N: 42F1-42F504	
Hydraulic Oil Filter.....	H-5508	160G (GRADERS)		Hydraulic Oil Filter.....	H-5503
153 (HYDRAULIC SYSTEMS) S/N: 51F1-UP		Hydraulic Oil Filter.....	H-55270	Hydraulic Oil Filter.....	H-5504
Hydraulic Oil Filter.....	H-5508	Hydraulic Oil Filter.....	H-5504	163 (HYDRAULIC SYSTEMS) S/N: 44G1-UP	
153 (HYDRAULIC SYSTEMS) S/N: 52G1-UP		160G (GRADERS) S/N: 4JD1-140		Hydraulic Oil Filter.....	H-5508
Hydraulic Oil Filter.....	H-5508	Hydraulic Oil Filter.....	H-55270	163 (HYDRAULIC SYSTEMS) S/N: 51F1-UP	
153 (HYDRAULIC SYSTEMS) S/N: 53G1-UP		Hydraulic Oil Filter.....	H-5504	Hydraulic Oil Filter.....	H-5508
Hydraulic Oil Filter.....	H-5508	160G (GRADERS) S/N: 4JD141-UP		163 (HYDRAULIC SYSTEMS) S/N: 52G1-UP	
160H (GRADERS) CAT 3306 (S/N: 2FM1-UP)		Hydraulic Oil Filter.....	H-55270	Hydraulic Oil Filter.....	H-5508
Hydraulic Oil Filter.....	H-5506	Hydraulic Oil Filter.....	H-5504	163 (HYDRAULIC SYSTEMS) S/N: 53G1-UP	
Hydraulic Oil Filter.....	H-55270	160M (GRADERS) CAT S/N: B9L1-UP		Hydraulic Oil Filter.....	H-5508
160H (GRADERS) CAT 3306 (S/N: 2HS1-UP)		Hydraulic Oil Filter.....	HC-5504	163 (HYDRAULIC SYSTEMS) S/N: 69F-69F	
Hydraulic Oil Filter.....	H-55270	160M (GRADERS) CAT S/N: CZM1-UP		Hydraulic Oil Filter.....	H-5504
Hydraulic Oil Filter.....	H-5506	Hydraulic Oil Filter.....	HC-5504	Hydraulic Oil Filter.....	H-5503
160H (GRADERS) S/N: 6WM1-UP		160M (GRADERS) CAT S/N: THX1-UP		163 (HYDRAULIC SYSTEMS) S/N: 70E1-70E284	
Hydraulic Oil Filter.....	H-55270	Hydraulic Oil Filter.....	HC-5504	Hydraulic Oil Filter.....	H-5504
Hydraulic Oil Filter.....	H-5504	161 (HYDRAULIC SYSTEMS) S/N: 54G1-UP		Hydraulic Oil Filter.....	H-5503
Hydraulic Oil Filter.....	H-5506	Hydraulic Oil Filter.....	H-5508	163 (HYDRAULIC SYSTEMS) S/N: 7X1-UP	
160H (GRADERS) S/N: 9EJ1-UP		161 (HYDRAULIC SYSTEMS) S/N: 62G7001-UP		Hydraulic Oil Filter.....	H-5508
Hydraulic Oil Filter.....	H-55270	Hydraulic Oil Filter.....	H-5508	163 (HYDRAULIC SYSTEMS) S/N: 8X1-UP	
Hydraulic Oil Filter.....	H-5506	163H (GRADERS) CAT 3176C ATAAC VHP		Hydraulic Oil Filter.....	H-5508
Hydraulic Oil Filter.....	H-5504	Hydraulic Oil Filter.....	H-5504	163 (HYDRAULIC SYSTEMS) S/N: 9X1-UP	
Hydraulic Oil Filter.....	H-5508	Hydraulic Oil Filter.....	H-5506	Hydraulic Oil Filter.....	H-5508
160H (GRADERS) S/N: 9JM1-UP		Hydraulic Oil Filter.....	H-55270	163H NA (GRADERS) S/N: 5AK1-UP	
Hydraulic Oil Filter.....	H-55270	Hydraulic Oil Filter.....	HC-5504	Hydraulic Oil Filter.....	H-55270
Hydraulic Oil Filter.....	H-5506	Hydraulic Oil Filter.....	H-5506	Hydraulic Oil Filter.....	HC-5504
Hydraulic Oil Filter.....	H-5504	163 (HYDRAULIC SYSTEMS) S/N: 38F1-38F3268		Hydraulic Oil Filter.....	H-5504
160H (GRADERS) S/N: 9JM1-UP		Hydraulic Oil Filter.....	H-5504	Hydraulic Oil Filter.....	H-5506
Hydraulic Oil Filter.....	H-5506	Hydraulic Oil Filter.....	H-5503	Hydraulic Oil Filter.....	H-5506
Hydraulic Oil Filter.....	H-55270	163 (HYDRAULIC SYSTEMS) S/N: 38G1-UP		165 (HYDRAULIC SYSTEMS) S/N: 38F1-38F3268	
Hydraulic Oil Filter.....	H-5504	Hydraulic Oil Filter.....	H-5508		



ENGINE APPLICATION

MODEL/APPLICATION	SAKURA NO	MODEL/APPLICATION	SAKURA NO	MODEL/APPLICATION	SAKURA NO
CATERPILLAR		CATERPILLAR		CATERPILLAR	
165 (HYDRAULIC SYSTEMS) S/N: 38F1-38F3268		16M (GRADERS) CAT S/N: MHX1-UP , 2007-UP		176 (HYDRAULIC SYSTEMS) S/N: 36E1-36E8992	
Hydraulic Oil Filter.....	H-5504	Hydraulic Oil Filter.....	HC-5504	Hydraulic Oil Filter.....	H-5504
Hydraulic Oil Filter.....	H-5503				
165 (HYDRAULIC SYSTEMS) S/N: 39F1-39F7840		16M (GRADERS) CAT S/N: B9H1-UP		182 (HYDRAULIC SYSTEMS) S/N: 38F1-38F3268	
Hydraulic Oil Filter.....	H-5503	Hydraulic Oil Filter.....	HC-5504	Hydraulic Oil Filter.....	H-5504
Hydraulic Oil Filter.....	H-5504			Hydraulic Oil Filter.....	H-5503
165 (HYDRAULIC SYSTEMS) S/N: 41F1-41F234		16M (GRADERS) CAT S/N: MHX1-UP		182 (HYDRAULIC SYSTEMS) S/N: 39F1-39F7849	
Hydraulic Oil Filter.....	H-5504	Hydraulic Oil Filter.....	HC-5504	Hydraulic Oil Filter.....	H-5503
Hydraulic Oil Filter.....	H-5503			Hydraulic Oil Filter.....	H-5504
165 (HYDRAULIC SYSTEMS) S/N: 42F1-42F504		172 (HYDRAULIC SYSTEMS) S/N: 24G1-24G252		182 (HYDRAULIC SYSTEMS) S/N: 41F1-41F234	
Hydraulic Oil Filter.....	H-5504	Hydraulic Oil Filter.....	H-5508	Hydraulic Oil Filter.....	H-5504
Hydraulic Oil Filter.....	H-5503			Hydraulic Oil Filter.....	H-5503
165 (HYDRAULIC SYSTEMS) S/N: 69F-69F		172 (HYDRAULIC SYSTEMS) S/N: 25G1-25G140		182 (HYDRAULIC SYSTEMS) S/N: 42F1-42F504	
Hydraulic Oil Filter.....	H-5504	Hydraulic Oil Filter.....	H-5508	Hydraulic Oil Filter.....	H-5504
Hydraulic Oil Filter.....	H-5503			Hydraulic Oil Filter.....	H-5503
165 (HYDRAULIC SYSTEMS) S/N: 70E1-70E284		172 (HYDRAULIC SYSTEMS) S/N: 48C1-UP		182 (HYDRAULIC SYSTEMS) S/N: 70E1-70E284	
Hydraulic Oil Filter.....	H-5504	Hydraulic Oil Filter.....	H-5508	Hydraulic Oil Filter.....	H-5503
Hydraulic Oil Filter.....	H-5503			Hydraulic Oil Filter.....	H-5504
16G (GRADERS) S/N: 93U1-UP		172 (HYDRAULIC SYSTEMS) S/N: 65G1-65G2567		183 (HYDRAULIC SYSTEMS) S/N: 27H1-UP	
Hydraulic Oil Filter.....	H-5504	Hydraulic Oil Filter.....	H-5508	Hydraulic Oil Filter.....	H-5503
Hydraulic Oil Filter.....	H-5508				
16G (GRADERS) S/N: 93U2511-2661		173 (HYDRAULIC SYSTEMS) S/N: 24G1-24G252		183 (HYDRAULIC SYSTEMS) S/N: 28H1-UP	
Hydraulic Oil Filter.....	H-5504	Hydraulic Oil Filter.....	H-5508	Hydraulic Oil Filter.....	H-5503
Hydraulic Oil Filter.....	H-55270				
16G (GRADERS) S/N: 93U2662-3459		173 (HYDRAULIC SYSTEMS) S/N: 48C1-UP		183 (HYDRAULIC SYSTEMS) S/N: 59P1-UP	
Hydraulic Oil Filter.....	H-5504	Hydraulic Oil Filter.....	H-5508	Hydraulic Oil Filter.....	H-5503
Hydraulic Oil Filter.....	H-55270				
16G (GRADERS) S/N: 93U3460-UP		173 (HYDRAULIC SYSTEMS) S/N: 65G1-65G2567		183 (HYDRAULIC SYSTEMS) S/N: 60P1-UP	
Hydraulic Oil Filter.....	H-55270	Hydraulic Oil Filter.....	H-5508	Hydraulic Oil Filter.....	H-5503
Hydraulic Oil Filter.....	H-5504				
16HNA (GRADERS)		173 (HYDRAULIC SYSTEMS) S/N: 67G1-UP		183B (HYDRAULIC SYSTEMS) S/N: 28A1-UP	
Hydraulic Oil Filter.....	H-55270	Hydraulic Oil Filter.....	H-5508	Hydraulic Oil Filter.....	H-5506
Hydraulic Oil Filter.....	H-5504				
Hydraulic Oil Filter.....	H-5506	173B (HYDRAULIC SYSTEMS) S/N: 41V1-UP		183B (HYDRAULIC SYSTEMS) S/N: 34H1-UP	
		Hydraulic Oil Filter.....	H-5506	Hydraulic Oil Filter.....	H-5503
16HNA (GRADERS) S/N: 62J1-UP		173B (HYDRAULIC SYSTEMS) S/N: 59P1-UP		183B (HYDRAULIC SYSTEMS) S/N: 35H1-UP	
Hydraulic Oil Filter.....	H-5504	Hydraulic Oil Filter.....	H-5503	Hydraulic Oil Filter.....	H-5503
Hydraulic Oil Filter.....	H-55270				
Hydraulic Oil Filter.....	H-5506	173B (HYDRAULIC SYSTEMS) S/N: 60P1-UP		183B (HYDRAULIC SYSTEMS) S/N: 41V1-UP	
		Hydraulic Oil Filter.....	H-5503	Hydraulic Oil Filter.....	H-5506
16M (GRADERS) CAT S/N: B9H1-UP , 2007-UP					
Hydraulic Oil Filter.....	HC-5504				



ENGINE APPLICATION

MODEL/APPLICATION	SAKURA NO	MODEL/APPLICATION	SAKURA NO	MODEL/APPLICATION	SAKURA NO
CATERPILLAR		CATERPILLAR		CATERPILLAR	
183B (HYDRAULIC SYSTEMS) S/N: 59P1-UP		193B (HYDRAULIC SYSTEMS) S/N: 28A1-UP		Hydraulic Oil Filter.....	H-5503
Hydraulic Oil Filter.....	H-5503	Hydraulic Oil Filter.....	H-5506	215B SA (EXCAVATORS) CAT 3204 (S/N: 4FC1-UP)	
183B (HYDRAULIC SYSTEMS) S/N: 60P1-UP		193B (HYDRAULIC SYSTEMS) S/N: 28H1-UP		Hydraulic Oil Filter.....	HC-5511
Hydraulic Oil Filter.....	H-5503	Hydraulic Oil Filter.....	H-5503	Hydraulic Oil Filter.....	H-5508
184 (HYDRAULIC SYSTEMS) S/N: 37E1-37E409		193B (HYDRAULIC SYSTEMS) S/N: 41V1-UP		Hydraulic Oil Filter.....	H-5503
Hydraulic Oil Filter.....	H-5503	Hydraulic Oil Filter.....	H-5506	215C (EXCAVATORS) CAT 3304 (S/N: 4HG1-UP)	
184 (HYDRAULIC SYSTEMS) S/N: 91F1-91F2566		193B (HYDRAULIC SYSTEMS) S/N: 42V1-UP		Hydraulic Oil Filter.....	HC-5511
Hydraulic Oil Filter.....	H-5503	Hydraulic Oil Filter.....	H-5506	Hydraulic Oil Filter.....	H-5508
192 (HYDRAULIC SYSTEMS) S/N: 38F1-38F3268		215 (EXCAVATORS) CAT 3402 (S/N: 14Z1-UP)		Hydraulic Oil Filter.....	H-5503
Hydraulic Oil Filter.....	H-5503	Hydraulic Oil Filter.....	H-5503	Hydraulic Oil Filter.....	HC-5511
Hydraulic Oil Filter.....	H-5504	Hydraulic Oil Filter.....	HC-5511	215C (EXCAVATORS) S/N: 44G1-UP	
192 (HYDRAULIC SYSTEMS) S/N: 39F1-39F7849		215 (EXCAVATORS) CAT 3402 (S/N: 57Y1-UP)		Hydraulic Oil Filter.....	H-5503
Hydraulic Oil Filter.....	H-5503	Hydraulic Oil Filter.....	H-5508	215D (EXCAVATORS) CAT 3304 (S/N: 9TF1-UP)	
Hydraulic Oil Filter.....	H-5504	Hydraulic Oil Filter.....	H-5503	Hydraulic Oil Filter.....	H-5508
192 (HYDRAULIC SYSTEMS) S/N: 41F1-41F234		215 (EXCAVATORS) CAT 3402 (S/N: 61Z1-UP)		Hydraulic Oil Filter.....	H-5503
Hydraulic Oil Filter.....	H-5503	Hydraulic Oil Filter.....	HC-5511	Hydraulic Oil Filter.....	HC-5511
Hydraulic Oil Filter.....	H-5504	Hydraulic Oil Filter.....	HC-5511	216 (LOADERS) S/N: 4NZ1-UP	
192 (HYDRAULIC SYSTEMS) S/N: 42F1-42F504		215 (EXCAVATORS) CAT 3402 (S/N: 95Z1-UP)		Hydraulic Oil Filter.....	HC-5504
Hydraulic Oil Filter.....	H-5503	Hydraulic Oil Filter.....	HC-5511	216 (LOADERS) S/N: 5FZ1-UP	
Hydraulic Oil Filter.....	H-5504	Hydraulic Oil Filter.....	H-5503	Hydraulic Oil Filter.....	HC-5504
192 (HYDRAULIC SYSTEMS) S/N: 62F-62F		215 (EXCAVATORS) S/N: 4FC1-UP		Hydraulic Oil Filter.....	HC-5504
Hydraulic Oil Filter.....	H-5503	Hydraulic Oil Filter.....	H-5503	216 (LOADERS) S/N: 6BZ1-699	
Hydraulic Oil Filter.....	H-5504	Hydraulic Oil Filter.....	H-5508	Hydraulic Oil Filter.....	HC-5504
192 (HYDRAULIC SYSTEMS) S/N: 70E1-70E284		215 (EXCAVATORS) S/N: 96L1-UP		216B (LOADERS) CAT 3024C (S/N: RLL1-UP) , 2004-UP	
Hydraulic Oil Filter.....	H-5503	Hydraulic Oil Filter.....	H-5503	Hydraulic Oil Filter.....	HC-5504
Hydraulic Oil Filter.....	H-5504	Hydraulic Oil Filter.....	H-5508	216B (LOADERS) CAT 3034 (S/N: RLL1-UP) , 2004-UP	
193 (HYDRAULIC SYSTEMS) S/N: 27H1-UP		215 (EXCAVATORS) S/N: 9YB1-UP		Hydraulic Oil Filter.....	HC-5504
Hydraulic Oil Filter.....	H-5503	Hydraulic Oil Filter.....	H-5508	219 (EXCAVATORS) CAT 3304 (S/N: 4HG1-UP)	
193 (HYDRAULIC SYSTEMS) S/N: 28H1-UP		215 (EXCAVATORS) S/N: 9YB1-UP		Hydraulic Oil Filter.....	HC-5511
Hydraulic Oil Filter.....	H-5503	Hydraulic Oil Filter.....	H-5503	Hydraulic Oil Filter.....	H-5503
193 (HYDRAULIC SYSTEMS) S/N: 37E1-37E409		215B (EXCAVATORS) CAT 3204 (S/N: 2XC1-UP)		Hydraulic Oil Filter.....	H-5508
Hydraulic Oil Filter.....	H-5503	Hydraulic Oil Filter.....	HC-5511	219 (EXCAVATORS) CAT 3304 (S/N: 5CF1-UP)	
193 (HYDRAULIC SYSTEMS) S/N: 91F1-91F2566		215B (EXCAVATORS) CAT 3204 (S/N: 9YB1-UP)		Hydraulic Oil Filter.....	H-5508
Hydraulic Oil Filter.....	H-5503	Hydraulic Oil Filter.....	H-5503	Hydraulic Oil Filter.....	HC-5511
193B (HYDRAULIC SYSTEMS) S/N: 27H1-UP		215B (EXCAVATORS) CAT 3204 (S/N: 9YB1-UP)		Hydraulic Oil Filter.....	H-5503
Hydraulic Oil Filter.....	H-5503	Hydraulic Oil Filter.....	H-5508	219D (EXCAVATORS) CAT 3304 (S/N: 5XG00982-UP)	
193B (HYDRAULIC SYSTEMS) S/N: 27H1-UP		215B (EXCAVATORS) CAT 3204 (S/N: 9YB1-UP)		Hydraulic Oil Filter.....	H-5503
Hydraulic Oil Filter.....	H-5503	Hydraulic Oil Filter.....	HC-5511		



ENGINE APPLICATION

MODEL/APPLICATION	SAKURA NO	MODEL/APPLICATION	SAKURA NO	MODEL/APPLICATION	SAKURA NO
CATERPILLAR		CATERPILLAR		CATERPILLAR	
219D (EXCAVATORS) CAT 3304 (S/N: 5XG00982-UP)		Hydraulic Oil Filter.....	H-5504	Hydraulic Oil Filter.....	H-5504
Hydraulic Oil Filter.....	H-5508	Hydraulic Oil Filter.....	H-5509	229 (EXCAVATORS) CAT 3304 (S/N: 1GF1-UP)	
Hydraulic Oil Filter.....	HC-5511	Hydraulic Oil Filter.....	H-5508	Hydraulic Oil Filter.....	H-5509
219D (EXCAVATORS) CAT 3304 (S/N: 5XG1-UP)		225B (EXCAVATORS) CAT 3304 (S/N: 3YD-UP)		Hydraulic Oil Filter.....	H-5504
Hydraulic Oil Filter.....	H-5503	Hydraulic Oil Filter.....	H-5503	Hydraulic Oil Filter.....	H-5504
Hydraulic Oil Filter.....	H-5508	Hydraulic Oil Filter.....	H-5509	Hydraulic Oil Filter.....	H-5508
Hydraulic Oil Filter.....	HC-5511	Hydraulic Oil Filter.....	H-5508	229 (EXCAVATORS) CAT 3304 (S/N: 2ZD1-UP)	
225 (EXCAVATORS) S/N: 20S1-UP		225B (EXCAVATORS) S/N: 1AG1-UP		Hydraulic Oil Filter.....	H-5509
Hydraulic Oil Filter.....	H-5508	Hydraulic Oil Filter.....	H-5504	Hydraulic Oil Filter.....	H-5504
225 (EXCAVATORS) S/N: 51U1-589		Hydraulic Oil Filter.....	H-5508	Hydraulic Oil Filter.....	H-5508
Hydraulic Oil Filter.....	H-5508	Hydraulic Oil Filter.....	H-5526	229 (EXCAVATORS) CAT 3304 (S/N: 3YD1-UP)	
Hydraulic Oil Filter.....	H-5509	Hydraulic Oil Filter.....	H-55270	Hydraulic Oil Filter.....	H-5509
Hydraulic Oil Filter.....	H-5504	Hydraulic Oil Filter.....	H-5509	Hydraulic Oil Filter.....	H-5503
225 (EXCAVATORS) S/N: 51U2832-UP		225B LC (EXCAVATORS) CAT 3208 (S/N: 1GF1-UP)		Hydraulic Oil Filter.....	H-5504
Hydraulic Oil Filter.....	H-5509	Hydraulic Oil Filter.....	H-5509	229D (EXCAVATORS) CAT 3304 (S/N: 2LJ1-UP)	
Hydraulic Oil Filter.....	H-5508	Hydraulic Oil Filter.....	H-5508	Hydraulic Oil Filter.....	H-5509
Hydraulic Oil Filter.....	H-5504	Hydraulic Oil Filter.....	H-5504	Hydraulic Oil Filter.....	H-5508
225 (EXCAVATORS) S/N: 51U590-2831		225B LC (EXCAVATORS) CAT 3208 (S/N: 2ZD1-UP)		Hydraulic Oil Filter.....	H-5504
Hydraulic Oil Filter.....	H-5508	Hydraulic Oil Filter.....	H-5508	231D (EXCAVATORS) CAT 3208 (S/N: 1NK1-UP)	
Hydraulic Oil Filter.....	H-5509	Hydraulic Oil Filter.....	H-5504	Hydraulic Oil Filter.....	H-5509
Hydraulic Oil Filter.....	H-5504	Hydraulic Oil Filter.....	H-5509	Hydraulic Oil Filter.....	H-5504
225 (EXCAVATORS) S/N: 61X1-UP		225D LC (EXCAVATORS) CAT 3208 (S/N: 6RG1-UP)		Hydraulic Oil Filter.....	H-5508
Hydraulic Oil Filter.....	H-5508	Hydraulic Oil Filter.....	H-5509	Hydraulic Oil Filter.....	H-5508
225 (EXCAVATORS) S/N: 76U1-UP		226 (LOADERS) S/N: 5FZ6700-UP		Hydraulic Oil Filter.....	H-5508
Hydraulic Oil Filter.....	H-5509	Hydraulic Oil Filter.....	HC-5504	231D (EXCAVATORS) CAT 3208 (S/N: 5JW1-UP)	
225D (EXCAVATORS) CAT 3304 (S/N: 25J1-UP)		226B (LOADERS) CAT 3024C (S/N: MJH1-UP) , 2004-UP		Hydraulic Oil Filter.....	H-5509
Hydraulic Oil Filter.....	H-5509	Hydraulic Oil Filter.....	HC-5504	Hydraulic Oil Filter.....	H-5503
Hydraulic Oil Filter.....	H-5504	226 (LOADERS) S/N: 6BZ1-699		Hydraulic Oil Filter.....	H-5508
Hydraulic Oil Filter.....	H-5508	Hydraulic Oil Filter.....	HC-5504	Hydraulic Oil Filter.....	H-5504
Hydraulic Oil Filter.....	H-5503	226B (LOADERS) CAT 3034 (S/N: MJH1-UP) , 2004-UP		231D LC (EXCAVATORS) CAT 3208 (S/N: 5JW1-UP)	
225B (EXCAVATORS) CAT 3304 (S/N: 2ZD1-UP)		Hydraulic Oil Filter.....	HC-5504	Hydraulic Oil Filter.....	H-5504
Hydraulic Oil Filter.....	H-5509	226B (LOADERS) CAT 3034 (S/N: MJH1-UP) , 2004-UP		Hydraulic Oil Filter.....	H-5508
Hydraulic Oil Filter.....	H-5504	Hydraulic Oil Filter.....	HC-5504	Hydraulic Oil Filter.....	H-5509
Hydraulic Oil Filter.....	H-5508	227 (EXCAVATORS) S/N: 10W1-UP		232 (LOADERS) CAT 3024C (S/N: CAB1-UP)	
Hydraulic Oil Filter.....	H-5509	Hydraulic Oil Filter.....	H-5509	Hydraulic Oil Filter.....	HC-5504
225B (EXCAVATORS) CAT 3304 (S/N: 2ZD-UP)		229 (EXCAVATORS) CAT 3304 (S/N: 1AG1-UP)		232 (LOADERS) CAT 3034 (S/N: CAB1-UP)	
Hydraulic Oil Filter.....	H-5503	Hydraulic Oil Filter.....	HC-5504	Hydraulic Oil Filter.....	HC-5504
Hydraulic Oil Filter.....	H-5504	Hydraulic Oil Filter.....	H-5509	232B (LOADERS) CAT 3024C (S/N: SCH1-UP) , 2004-UP	
Hydraulic Oil Filter.....	H-5508	Hydraulic Oil Filter.....	H-5508	Hydraulic Oil Filter.....	HC-5504
Hydraulic Oil Filter.....	H-5509	Hydraulic Oil Filter.....	H-5503		
225B (EXCAVATORS) CAT 3304 (S/N: 3YD1-UP)		Hydraulic Oil Filter.....	H-5503		
Hydraulic Oil Filter.....	H-5503				



ENGINE APPLICATION

MODEL/APPLICATION	SAKURA NO	MODEL/APPLICATION	SAKURA NO	MODEL/APPLICATION	SAKURA NO
CATERPILLAR		CATERPILLAR		CATERPILLAR	
232B (LOADERS) CAT 3024C (S/N: SCH1-UP) , 2004-UP Hydraulic Oil Filter.....	HC-5504	Hydraulic Oil Filter.....	H-5503	Hydraulic Oil Filter.....	HC-5504
232B (LOADERS) CAT 3034 (S/N: SCH1-UP) , 2004-UP Hydraulic Oil Filter.....	HC-5504	Hydraulic Oil Filter.....	H-5504	236 (LOADERS) S/N: 5521-3999 Hydraulic Oil Filter.....	HC-5504
235 (EXCAVATORS) S/N: 32K1-788 Hydraulic Oil Filter.....	H-5508	235C (EXCAVATORS) CAT 3306 (S/N: 4DG1-UP) Hydraulic Oil Filter.....	H-5509	236 (LOADERS) S/N: 5524000-UP Hydraulic Oil Filter.....	HC-5504
Hydraulic Oil Filter.....	H-5504	Hydraulic Oil Filter.....	H-5508	236 (LOADERS) S/N: 6L21000-UP Hydraulic Oil Filter.....	HC-5504
Hydraulic Oil Filter.....	H-5509	Hydraulic Oil Filter.....	H-5503	236 (LOADERS) S/N: 6L21-999 Hydraulic Oil Filter.....	HC-5504
235 (EXCAVATORS) S/N: 32K789-UP Hydraulic Oil Filter.....	H-5509	235C (EXCAVATORS) CAT 3306 (S/N: 5AF1-UP) Hydraulic Oil Filter.....	H-5504	236 (LOADERS) S/N: 6L21-999 Hydraulic Oil Filter.....	HC-5504
Hydraulic Oil Filter.....	H-5508	Hydraulic Oil Filter.....	H-5509	236 (LOADERS) S/N: CED1-UP Hydraulic Oil Filter.....	HC-5504
Hydraulic Oil Filter.....	H-5508	235D (EXCAVATORS) CAT 3306 (S/N: 8KJ1-UP) Hydraulic Oil Filter.....	H-5509	236 (LOADERS) S/N: FDG1-UP Hydraulic Oil Filter.....	HC-5504
235 (EXCAVATORS) S/N: 62X1-UP Hydraulic Oil Filter.....	H-5509	Hydraulic Oil Filter.....	H-5504	236B (LOADERS) S/N: HEN1-UP , 2004-UP Hydraulic Oil Filter.....	HC-5504
Hydraulic Oil Filter.....	H-5508	Hydraulic Oil Filter.....	H-5508	242 (LOADERS) CAT 3024C (S/N: CMB1-UP) Hydraulic Oil Filter.....	HC-5504
Hydraulic Oil Filter.....	H-5504	Hydraulic Oil Filter.....	H-5509	242 (LOADERS) CAT 3034 (S/N: CMB1-UP) Hydraulic Oil Filter.....	HC-5504
235 (EXCAVATORS) S/N: 7WC1-UP Hydraulic Oil Filter.....	H-5509	235D (EXCAVATORS) CAT 3306 (S/N: 8TJ1-UP) Hydraulic Oil Filter.....	H-5504	242B (LOADERS) CAT 3024C (S/N: 5SZ4000-UP) , 2004-UP Hydraulic Oil Filter.....	HC-5504
Hydraulic Oil Filter.....	H-5508	Hydraulic Oil Filter.....	H-5508	242B (LOADERS) CAT 3034 (S/N: 5SZ4000-UP) , 2004-UP Hydraulic Oil Filter.....	HC-5504
Hydraulic Oil Filter.....	H-5509	Hydraulic Oil Filter.....	H-5503	242B (LOADERS) CAT 3034 (S/N: 5SZ4000-UP) , 2004-UP Hydraulic Oil Filter.....	HC-5504
235 (EXCAVATORS) S/N: 81X1-UP Hydraulic Oil Filter.....	H-5504	235B (EXCAVATORS) CAT 3306 (S/N: 1FD1-UP) Hydraulic Oil Filter.....	H-5509	242B (LOADERS) CAT 3024C (S/N: BXM1-UP) Hydraulic Oil Filter.....	HC-5504
Hydraulic Oil Filter.....	H-5509	Hydraulic Oil Filter.....	H-5508	242B (LOADERS) CAT 3034 (S/N: BXM1-UP) Hydraulic Oil Filter.....	HC-5504
Hydraulic Oil Filter.....	H-5508	Hydraulic Oil Filter.....	H-5504	245 (EXCAVATORS) S/N: 82X1-UP Hydraulic Oil Filter.....	H-5509
235 (EXCAVATORS) S/N: 83X1-UP Hydraulic Oil Filter.....	H-5504	Hydraulic Oil Filter.....	H-5508	245 (EXCAVATORS) S/N: 84X1-UP Hydraulic Oil Filter.....	H-5509
Hydraulic Oil Filter.....	H-5508	235B (EXCAVATORS) CAT 3306 (S/N: 4ED1-UP) Hydraulic Oil Filter.....	H-5503	245 (EXCAVATORS) S/N: 95V1-470 Hydraulic Oil Filter.....	H-5509
Hydraulic Oil Filter.....	H-5509	Hydraulic Oil Filter.....	H-5504	245 (EXCAVATORS) S/N: 95V471-UP Hydraulic Oil Filter.....	H-5509
235 (EXCAVATORS) S/N: 9PC1-UP Hydraulic Oil Filter.....	H-5508	Hydraulic Oil Filter.....	H-5503		
Hydraulic Oil Filter.....	H-5509	235B (EXCAVATORS) CAT 3306 (S/N: 7WC1-UP) Hydraulic Oil Filter.....	H-5504		
235C (EXCAVATORS) CAT 3306 (S/N: 2PG1-UP) Hydraulic Oil Filter.....	H-5503	Hydraulic Oil Filter.....	H-5509		
Hydraulic Oil Filter.....	H-5508	Hydraulic Oil Filter.....	H-5503		
Hydraulic Oil Filter.....	H-5504	Hydraulic Oil Filter.....	H-5504		
Hydraulic Oil Filter.....	H-5509	Hydraulic Oil Filter.....	H-5508		
235C (EXCAVATORS) CAT 3306 (S/N: 3WG1-UP) Hydraulic Oil Filter.....	H-5509	236 (LOADERS) S/N: 4YZ1-3999 Hydraulic Oil Filter.....	HC-5504		
Hydraulic Oil Filter.....	H-5508	236 (LOADERS) S/N: 4YZ4000-UP Hydraulic Oil Filter.....	HC-5504		



ENGINE APPLICATION

MODEL/APPLICATION	SAKURA NO	MODEL/APPLICATION	SAKURA NO	MODEL/APPLICATION	SAKURA NO
CATERPILLAR		CATERPILLAR		CATERPILLAR	
245 (EXCAVATORS) S/N: 95V471-UP Hydraulic Oil Filter.....	H-5509	246 (LOADERS) S/N: 4YZ1-3999 Hydraulic Oil Filter.....	HC-5504	252B (LOADERS) S/N: FDG1-UP Hydraulic Oil Filter.....	HC-5504
245B (EXCAVATORS) CAT 3406 (S/N: 1S11-712-UP) Hydraulic Oil Filter..... Hydraulic Oil Filter.....	H-5509 H-5508	246B (LOADERS) S/N: PAT1-UP , 2004-UP Hydraulic Oil Filter.....	HC-5504	256C (DOZERS) CAT S/N: CJS1-UP Hydraulic Oil Filter.....	HC-5504
245B (EXCAVATORS) CAT 3406 (S/N: 6MF1-512-UP) Hydraulic Oil Filter..... Hydraulic Oil Filter.....	H-5509 H-5508	246C (SKIDDERS) CAT S/N: CJS1-UP , 2007-UP Hydraulic Oil Filter.....	HC-5504	256C (DOZERS) CAT S/N: DWS1-UP Hydraulic Oil Filter.....	HC-5504
245B (EXCAVATORS) CAT 3406 (S/N: 6MF513-UP) Hydraulic Oil Filter..... Hydraulic Oil Filter.....	H-5509 H-5508	246C (SKIDDERS) CAT S/N: JAY1-UP , 2007-UP Hydraulic Oil Filter.....	HC-5504	257 (LOADERS) CAT 3034 (S/N: CMM1-UP) Hydraulic Oil Filter.....	HC-5504
245B (EXCAVATORS) S/N: 6MF00369-6MF00654 Hydraulic Oil Filter.....	H-5508	247 (LOADERS) CAT 3034 (S/N: CML1-UP) Hydraulic Oil Filter.....	HC-5504	262 (LOADERS) S/N: 4YZ4000-UP Hydraulic Oil Filter.....	HC-5504
245B II (EXCAVATORS) CAT S/N: 11N1-UP Hydraulic Oil Filter..... Hydraulic Oil Filter.....	H-5509 H-5508	248 (LOADERS) S/N: 6LZ1-999 Hydraulic Oil Filter.....	HC-5504	262B (LOADERS) S/N: PDT1-UP , 2004-UP Hydraulic Oil Filter.....	HC-5504
245B II (EXCAVATORS) CAT S/N: 6MF1-UP Hydraulic Oil Filter..... Hydraulic Oil Filter.....	H-5509 H-5508	248 (LOADERS) S/N: FYZ1-3999 Hydraulic Oil Filter.....	HC-5504	262C (DOZERS) CAT S/N: CJS1-UP Hydraulic Oil Filter.....	HC-5504
245B SERIES II (EXCAVATORS) CAT 3406 (S/N: 1S1713-UP) Hydraulic Oil Filter..... Hydraulic Oil Filter.....	H-5508 H-5509	248B (LOADERS) S/N: SCL1-UP , 2004-UP Hydraulic Oil Filter.....	HC-5504	262C (DOZERS) CAT S/N: MST1-UP Hydraulic Oil Filter.....	HC-5504
245B SERIES II (EXCAVATORS) CAT 3406 (S/N: 6MF513-UP) Hydraulic Oil Filter..... Hydraulic Oil Filter.....	H-5509 H-5508	24H (GRADERS) CAT 3412E HEUI (S/N: 7KK1-UP) Hydraulic Oil Filter..... Hydraulic Oil Filter..... Hydraulic Oil Filter..... Hydraulic Oil Filter..... Hydraulic Oil Filter..... Hydraulic Oil Filter.....	HC-55300 H-55280 H-5503 HC-5516 H-5526 H-5506	267 (LOADERS) CAT 3034 (S/N: CMP1-UP) Hydraulic Oil Filter.....	HC-5504
245D (EXCAVATORS) CAT 3406 (S/N: 4LK1-UP) Hydraulic Oil Filter..... Hydraulic Oil Filter.....	H-5508 H-5509	24H (GRADERS) S/N: 7KK1-66-UP Hydraulic Oil Filter..... Hydraulic Oil Filter..... Hydraulic Oil Filter..... Hydraulic Oil Filter.....	H-55280 HC-55300 H-5503 H-5526 H-5506	267B (LOADERS) CAT 3034 (S/N: CYC1-UP) Hydraulic Oil Filter.....	HC-5504
245D (EXCAVATORS) CAT 3406 (S/N: 7Z11-UP) Hydraulic Oil Filter..... Hydraulic Oil Filter.....	H-5508 H-5509	24H (GRADERS) S/N: 7KK67-UP Hydraulic Oil Filter..... Hydraulic Oil Filter..... Hydraulic Oil Filter..... Hydraulic Oil Filter.....	H-5503 H-5526 H-5506 H-55280 HC-55300	268B (LOADERS) CAT 3044C (S/N: LBA1-UP) , 2004-UP Hydraulic Oil Filter.....	HC-5504
246 (SKIDDERS) CAT 3034 S/N: 3NW17565-UP , 2001 Hydraulic Oil Filter.....	HC-5504	246 (SKIDDERS) CAT 3034 S/N: 59203641-UP , 2001 Hydraulic Oil Filter.....	HC-5504	272C (DOZERS) CAT S/N: CJS1-UP Hydraulic Oil Filter.....	HC-5504
246 (LOADERS) CAT 3034 (S/N: 5SZ1-3999-UP) Hydraulic Oil Filter.....	HC-5504	252 (LOADERS) S/N: 4YZ4000-UP Hydraulic Oil Filter.....	HC-5504	272C (DOZERS) CAT S/N: RED1-UP Hydraulic Oil Filter.....	HC-5504
246 (LOADERS) CAT 3034 (S/N: 5SZ24000-UP) Hydraulic Oil Filter.....	HC-5504	252 (LOADERS) S/N: 5SZ4000-UP Hydraulic Oil Filter.....	HC-5504	277 (LOADERS) CAT 3034 (S/N: CNC1-UP) Hydraulic Oil Filter.....	HC-5504
				277B (LOADERS) CAT 3034 (S/N: MDH1-UP) Hydraulic Oil Filter.....	HC-5504
				277C (DOZERS) CAT S/N: CJS1-UP Hydraulic Oil Filter.....	HC-5504
				277C (DOZERS) CAT S/N: JWF1-UP Hydraulic Oil Filter.....	HC-5504



ENGINE APPLICATION

MODEL/APPLICATION	SAKURA NO	MODEL/APPLICATION	SAKURA NO	MODEL/APPLICATION	SAKURA NO
CATERPILLAR		CATERPILLAR		CATERPILLAR	
287 (LOADERS) CAT 3034 (S/N: CNY1-UP) Hydraulic Oil Filter.....	HC-5504	Hydraulic Oil Filter.....	HC-5801	Hydraulic Oil Filter.....	HC-5801
287B (LOADERS) CAT 3034 (S/N: ZSA1-UP) Hydraulic Oil Filter.....	HC-5504	Hydraulic Oil Filter.....	H-7942	312B (EXCAVATORS) CAT 3064 (S/N: 2NS1-UP) Hydraulic Oil Filter.....	H-7942
287C (DOZERS) CAT S/N: CJS1--UP , 2007-UP Hydraulic Oil Filter.....	HC-5504	311C (EXCAVATORS) CAT 3064 (S/N: CKE01001-UP) Hydraulic Oil Filter.....	H-7942	Hydraulic Oil Filter.....	HC-5801
287C (DOZERS) CAT S/N: GCP1-UP , 2007-UP Hydraulic Oil Filter.....	HC-5504	Hydraulic Oil Filter.....	HC-5801	312B (EXCAVATORS) CAT 3064 (S/N: 3FS1-UP) Hydraulic Oil Filter.....	HC-5801
287C (DOZERS) CAT S/N: MAS1-UP , 2007-UP Hydraulic Oil Filter.....	HC-5504	312C (EXCAVATORS) CAT 3064 (S/N: BNN1-UP) Hydraulic Oil Filter.....	HC-5801	Hydraulic Oil Filter.....	H-7942
301.5 (EXCAVATORS) CAT 3003 (S/N: 3YW1-UP) Hydraulic Oil Filter.....	HC-5504	Hydraulic Oil Filter.....	H-7942	312B (EXCAVATORS) CAT 3064 (S/N: 6SW1-UP) Hydraulic Oil Filter.....	HC-5801
307 (EXCAVATORS) L4 3.6L 3600cc 220 CID , 3600 Hydraulic Oil Filter.....	H-5519	312C (EXCAVATORS) CAT 3064 (S/N: BMH1-UP) Hydraulic Oil Filter.....	H-5522	Hydraulic Oil Filter.....	H-7942
307 (EXCAVATORS) L4 4.4L 4400cc 268.5 CID , 4400 Hydraulic Oil Filter.....	H-5519	Hydraulic Oil Filter.....	HC-5801	312B (EXCAVATORS) CAT 3064 (S/N: 8JR1-UP) Hydraulic Oil Filter.....	HC-5801
307B (EXCAVATORS) w/Mitsubishi 4M40 Eng Hydraulic Oil Filter.....	H-5519	312C (EXCAVATORS) CAT 3064 (S/N: CBA1-UP) Hydraulic Oil Filter.....	H-7942	Hydraulic Oil Filter.....	H-7942
307C (EXCAVATORS) L4 2.8L 2800cc 173 CID , 2800 Hydraulic Oil Filter.....	H-5519	Hydraulic Oil Filter.....	HC-5801	312B L (EXCAVATORS) CAT 3064 (S/N: 2KW1-UP) Hydraulic Oil Filter.....	H-7942
308C (EXCAVATORS) S/N: KCX1-UP Hydraulic Oil Filter.....	HC-55170	312C (EXCAVATORS) CAT 3064 (S/N: CBT1-UP) Hydraulic Oil Filter.....	HC-5801	Hydraulic Oil Filter.....	H-7942
311CU (EXCAVATORS) CAT 3064T (S/N: CKE1-UP) Hydraulic Oil Filter.....	H-7942	Hydraulic Oil Filter.....	H-7942	312B L (EXCAVATORS) CAT 3064 (S/N: 3FS1-UP) Hydraulic Oil Filter.....	HC-5801
Hydraulic Oil Filter.....	HC-5801	312C L (EXCAVATORS) CAT 3064 (S/N: CBA1-UP) Hydraulic Oil Filter.....	H-7942	Hydraulic Oil Filter.....	H-7942
311CU (EXCAVATORS) CAT 3116 (S/N: CKE01001-UP) Hydraulic Oil Filter.....	H-7942	Hydraulic Oil Filter.....	HC-5801	312B L (EXCAVATORS) CAT 3064 (S/N: 6SW1-UP) Hydraulic Oil Filter.....	HC-5801
Hydraulic Oil Filter.....	HC-5801	312C L (EXCAVATORS) CAT 3064 (S/N: CBT1-UP) Hydraulic Oil Filter.....	H-7942	Hydraulic Oil Filter.....	H-7942
311CU (EXCAVATORS) CAT 3116 (S/N: CKE1-UP) Hydraulic Oil Filter.....	H-7942	Hydraulic Oil Filter.....	HC-5801	312B L (EXCAVATORS) CAT 3064 (S/N: 8JR1-UP) Hydraulic Oil Filter.....	H-7942
Hydraulic Oil Filter.....	HC-5801	312C L (EXCAVATORS) CAT 3064 (S/N: DBN1-UP) Hydraulic Oil Filter.....	H-5522	Hydraulic Oil Filter.....	HC-5801
311B (EXCAVATORS) CAT 3064 (S/N: 2LS1-UP) Hydraulic Oil Filter.....	H-7942	Hydraulic Oil Filter.....	HC-5801	312B L (EXCAVATORS) CAT 3064 (S/N: 9FS1-UP) Hydraulic Oil Filter.....	H-7942
Hydraulic Oil Filter.....	HC-5801	312C L (EXCAVATORS) CAT 3064 (S/N: FDS1-UP) Hydraulic Oil Filter.....	HC-5801	Hydraulic Oil Filter.....	HC-5801
311B (EXCAVATORS) CAT 3064 (S/N: 8GR1-UP) Hydraulic Oil Filter.....	HC-5801	Hydraulic Oil Filter.....	H-7942	312B L (EXCAVATORS) CAT 3064 (S/N: 9GR1-UP) Hydraulic Oil Filter.....	H-7942
		312C L (EXCAVATORS) S/N: BNN1-UP Hydraulic Oil Filter.....	H-7942	Hydraulic Oil Filter.....	HC-5801
		Hydraulic Oil Filter.....	HC-5801	312B L (EXCAVATORS) CAT 3064 (S/N: 9NW1-UP) Hydraulic Oil Filter.....	H-7942
		312B (EXCAVATORS) CAT 3064 (S/N: 2KW1-UP) Hydraulic Oil Filter.....	H-7942	Hydraulic Oil Filter.....	HC-5801
		Hydraulic Oil Filter.....	H-7942		



ENGINE APPLICATION

MODEL/APPLICATION	SAKURA NO	MODEL/APPLICATION	SAKURA NO	MODEL/APPLICATION	SAKURA NO
CATERPILLAR		CATERPILLAR		CATERPILLAR	
314C (EXCAVATORS) CAT 3064 (S/N: KJA1-UP)		315B (EXCAVATORS) S/N: 3AW1-UP		318B (EXCAVATORS) S/N: 3LR1-UP	
Hydraulic Oil Filter.....	H-7942	Hydraulic Oil Filter.....	HC-5801	Hydraulic Oil Filter.....	H-7942
Hydraulic Oil Filter.....	HC-5801	Hydraulic Oil Filter.....	H-7942	Hydraulic Oil Filter.....	HC-5801
314C (EXCAVATORS) CAT 3064 (S/N: PCA1-UP)		317B (EXCAVATORS) CAT S/N: 5XK484-9970-UP		318B (EXCAVATORS) S/N: 7KZ1-UP	
Hydraulic Oil Filter.....	H-7942	Hydraulic Oil Filter.....	H-7942	Hydraulic Oil Filter.....	H-7942
Hydraulic Oil Filter.....	HC-5801	Hydraulic Oil Filter.....	HC-5801	Hydraulic Oil Filter.....	HC-5801
314C CR (EXCAVATORS) CAT 3145 (S/N: KJA1-UP)		317B (EXCAVATORS) CAT S/N: 5XK9971-UP		318B (EXCAVATORS) S/N: ADC1-UP	
Hydraulic Oil Filter.....	HC-5801	Hydraulic Oil Filter.....	H-7942	Hydraulic Oil Filter.....	H-7942
Hydraulic Oil Filter.....	H-7942	Hydraulic Oil Filter.....	HC-5801	Hydraulic Oil Filter.....	HC-5801
314C CR (EXCAVATORS) CAT 3145 (S/N: PCA1-UP)		317B (EXCAVATORS) CAT S/N: 6DZ1-UP		318B (EXCAVATORS) S/N: AEJ1-UP	
Hydraulic Oil Filter.....	HC-5801	Hydraulic Oil Filter.....	H-7942	Hydraulic Oil Filter.....	H-7942
Hydraulic Oil Filter.....	H-7942	Hydraulic Oil Filter.....	HC-5801	Hydraulic Oil Filter.....	HC-5801
315C (EXCAVATORS) CAT 3054 (S/N: AKE1-UP)		317B (EXCAVATORS) CAT S/N: 9WW1-UP		318C LN (EXCAVATORS) CAT 3046 (S/N: FAA1-UP)	
Hydraulic Oil Filter.....	HC-5801	Hydraulic Oil Filter.....	H-7942	Hydraulic Oil Filter.....	H-7942
Hydraulic Oil Filter.....	H-7942	Hydraulic Oil Filter.....	HC-5801	Hydraulic Oil Filter.....	HC-5801
315C (EXCAVATORS) CAT 3054 (S/N: CFB1-UP)		317B L (EXCAVATORS) CAT 3046 (S/N: 6DZ1-UP)		319C (EXCAVATORS) CAT S/N: 7JK1-UP	
Hydraulic Oil Filter.....	HC-5801	Hydraulic Oil Filter.....	H-7942	Hydraulic Oil Filter.....	HC-5801
Hydraulic Oil Filter.....	H-7942	Hydraulic Oil Filter.....	HC-5801	Hydraulic Oil Filter.....	H-5522
315C (EXCAVATORS) CAT 3054 (S/N: CFT1-UP)		317B L (EXCAVATORS) CAT 3046 (S/N: 9WW1-UP)		Hydraulic Oil Filter.....	HC-55170
Hydraulic Oil Filter.....	HC-5801	Hydraulic Oil Filter.....	H-7942	319C (EXCAVATORS) CAT S/N: KGL1-UP	
Hydraulic Oil Filter.....	H-7942	Hydraulic Oil Filter.....	HC-5801	Hydraulic Oil Filter.....	HC-5801
315C L (EXCAVATORS) CAT 3150 (S/N: ANF1-UP)		318C (EXCAVATORS) CAT 3066 (S/N: AWS1-UP) , 2004-UP		Hydraulic Oil Filter.....	HC-55170
Hydraulic Oil Filter.....	H-5522	Hydraulic Oil Filter.....	H-7942	Hydraulic Oil Filter.....	H-5522
Hydraulic Oil Filter.....	HC-5801	Hydraulic Oil Filter.....	HC-5801	320 (EXCAVATORS) CAT 3066 (S/N: 3RK1-UP)	
315C L (EXCAVATORS) CAT 3150 (S/N: CFB1-UP)		318C (EXCAVATORS) CAT 3066 (S/N: MDY1-UP) , 2004-UP		Hydraulic Oil Filter.....	H-5505
Hydraulic Oil Filter.....	H-7942	Hydraulic Oil Filter.....	HC-5801	320 (EXCAVATORS) CAT 3066 (S/N: 7WK1-UP)	
Hydraulic Oil Filter.....	HC-5801	Hydraulic Oil Filter.....	H-7942	Hydraulic Oil Filter.....	H-5505
315C L (EXCAVATORS) CAT 3150 (S/N: CFT1-UP)		318C (EXCAVATORS) CAT 3066 (S/N: BTG1-UP)		320 (EXCAVATORS) CAT 3116 (S/N: 1KL1-UP)	
Hydraulic Oil Filter.....	HC-5801	Hydraulic Oil Filter.....	HC-5801	Hydraulic Oil Filter.....	H-5505
Hydraulic Oil Filter.....	H-7942	Hydraulic Oil Filter.....	H-7942	Hydraulic Oil Filter.....	HC-5505
315C L (EXCAVATORS) CAT 3150 (S/N: CJC1-UP)		318C (EXCAVATORS) CAT 3066 (S/N: DAH1-UP)		Hydraulic Oil Filter.....	H-5505
Hydraulic Oil Filter.....	H-7942	Hydraulic Oil Filter.....	HC-5801	Hydraulic Oil Filter.....	HC-5801
Hydraulic Oil Filter.....	HC-5801	Hydraulic Oil Filter.....	H-7942	320 (EXCAVATORS) CAT 3116 (S/N: 1XM1-UP)	
315B (EXCAVATORS) CAT 3046 (S/N: 5SW1-UP)		318C (EXCAVATORS) CAT 3066 (S/N: GPA1-UP)		Hydraulic Oil Filter.....	HC-5505
Hydraulic Oil Filter.....	H-7942	Hydraulic Oil Filter.....	H-7942	Hydraulic Oil Filter.....	HC-5505
Hydraulic Oil Filter.....	HC-5801	Hydraulic Oil Filter.....	HC-5801	Hydraulic Oil Filter.....	H-5505
315B (EXCAVATORS) S/N: 15W1-UP		318CL (EXCAVATORS) CAT 3046 (S/N: DAH1-UP)		320 (EXCAVATORS) CAT 3116 (S/N: 2DL1-UP)	
Hydraulic Oil Filter.....	HC-5801	Hydraulic Oil Filter.....	H-7942	Hydraulic Oil Filter.....	HC-5505
Hydraulic Oil Filter.....	H-7942	Hydraulic Oil Filter.....	HC-5801	Hydraulic Oil Filter.....	H-5505



ENGINE APPLICATION

MODEL/APPLICATION	SAKURA NO	MODEL/APPLICATION	SAKURA NO	MODEL/APPLICATION	SAKURA NO
CATERPILLAR		CATERPILLAR		CATERPILLAR	
320 (EXCAVATORS) CAT 3116 (S/N: 2DL-UP)		320B (EXCAVATORS) CAT 3116 (S/N: 1XS1-UP)		Hydraulic Oil Filter.....	H-7942
Hydraulic Oil Filter.....	HC-5505	Hydraulic Oil Filter.....	HC-5801	Hydraulic Oil Filter.....	HC-5505
Hydraulic Oil Filter.....	H-5505	Hydraulic Oil Filter.....	H-7942		
		Hydraulic Oil Filter.....	HC-5505	320BL (EXCAVATORS) S/N: 7JR1954-UP	
320 (EXCAVATORS) CAT 3116 (S/N: 3RK-UP)		320B (EXCAVATORS) CAT 3116 (S/N: 2AS1-UP)		Hydraulic Oil Filter.....	HC-5505
Hydraulic Oil Filter.....	H-5505	Hydraulic Oil Filter.....	H-7942	Hydraulic Oil Filter.....	H-7942
Hydraulic Oil Filter.....	HC-5505	Hydraulic Oil Filter.....	HC-5801		
		Hydraulic Oil Filter.....	HC-5505	320BL (EXCAVATORS) S/N: 7JR1960-UP	
320 (EXCAVATORS) CAT 3116 (S/N: 3XK822-UP)		320B (EXCAVATORS) CAT 3116 (S/N: 3YZ1-UP)		Hydraulic Oil Filter.....	HC-5505
Hydraulic Oil Filter.....	H-5505	Hydraulic Oil Filter.....	HC-5505	Hydraulic Oil Filter.....	H-7942
Hydraulic Oil Filter.....	HC-5505	Hydraulic Oil Filter.....	HC-5801		
		Hydraulic Oil Filter.....	HC-5505	320BL (EXCAVATORS) S/N: 7JR2461-UP	
320 (EXCAVATORS) CAT 3116 (S/N: 3XM-UP)		320B (EXCAVATORS) CAT 3116 (S/N: 4XW1-UP)		Hydraulic Oil Filter.....	HC-5505
Hydraulic Oil Filter.....	H-5505	Hydraulic Oil Filter.....	HC-5801	Hydraulic Oil Filter.....	H-7942
Hydraulic Oil Filter.....	HC-5505	Hydraulic Oil Filter.....	H-7942	Hydraulic Oil Filter.....	HC-5801
		320B (EXCAVATORS) CAT 3116 (S/N: 5BR1-UP)			
320 (EXCAVATORS) CAT 3116 (S/N: 4ZJ460-UP)		320B (EXCAVATORS) CAT 3116 (S/N: 5GW1-UP)		320C (EXCAVATORS) CAT 3066 (S/N: AKH1-UP)	
Hydraulic Oil Filter.....	H-5505	Hydraulic Oil Filter.....	HC-5801	Hydraulic Oil Filter.....	H-5522
Hydraulic Oil Filter.....	HC-5505	Hydraulic Oil Filter.....	H-7942	Hydraulic Oil Filter.....	HC-5801
		Hydraulic Oil Filter.....	HC-5505	Hydraulic Oil Filter.....	H-7942
320 (EXCAVATORS) CAT 3116 (S/N: 4ZJ-UP)		320B (EXCAVATORS) CAT 3116 (S/N: 6CR1-UP)		320C (EXCAVATORS) CAT 3066 (S/N: ALF1-UP)	
Hydraulic Oil Filter.....	H-5505	Hydraulic Oil Filter.....	H-7942	Hydraulic Oil Filter.....	HC-5801
Hydraulic Oil Filter.....	HC-5505	Hydraulic Oil Filter.....	HC-5801	Hydraulic Oil Filter.....	H-7942
		320B (EXCAVATORS) CAT 3116 (S/N: 6LW1-UP)		320C (EXCAVATORS) CAT 3066 (S/N: ANB1-UP)	
320 (EXCAVATORS) CAT 3116 (S/N: 6KM1-UP)		Hydraulic Oil Filter.....	H-7942	Hydraulic Oil Filter.....	H-7942
Hydraulic Oil Filter.....	HC-5505	Hydraulic Oil Filter.....	HC-5505		
Hydraulic Oil Filter.....	H-5505	Hydraulic Oil Filter.....	H-7942	320C (EXCAVATORS) CAT 3066 (S/N: AMC1-UP)	
		Hydraulic Oil Filter.....	HC-5801	Hydraulic Oil Filter.....	HC-5801
320 (EXCAVATORS) CAT 3116 (S/N: 7WK-UP)		320B (EXCAVATORS) CAT 3116 (S/N: 7JR1-UP)		Hydraulic Oil Filter.....	H-7942
Hydraulic Oil Filter.....	HC-5505	Hydraulic Oil Filter.....	HC-5505		
Hydraulic Oil Filter.....	H-5505	Hydraulic Oil Filter.....	H-7942	320C (EXCAVATORS) CAT 3066 (S/N: BNC1-UP)	
		Hydraulic Oil Filter.....	HC-5801	Hydraulic Oil Filter.....	H-7942
320 (EXCAVATORS) CAT 3116 (S/N: 8LW1-UP)		320B (EXCAVATORS) CAT 3116 (S/N: 9WS1-UP)		Hydraulic Oil Filter.....	HC-5801
Hydraulic Oil Filter.....	HC-5801	Hydraulic Oil Filter.....	H-7942		
Hydraulic Oil Filter.....	HC-5505	Hydraulic Oil Filter.....	HC-5505	320C (EXCAVATORS) CAT 3066 (S/N: BDC1-UP)	
Hydraulic Oil Filter.....	H-5505			Hydraulic Oil Filter.....	H-7942
320 (EXCAVATORS) CAT 3116 (S/N: 8LW1-UP)					
Hydraulic Oil Filter.....	HC-5801				
Hydraulic Oil Filter.....	HC-5505				
Hydraulic Oil Filter.....	H-5505				
320 (EXCAVATORS) CAT 3116 (S/N: 8LW1-UP)					
Hydraulic Oil Filter.....	HC-5801				
Hydraulic Oil Filter.....	HC-5505				
Hydraulic Oil Filter.....	H-5505				
320 (EXCAVATORS) CAT 3116 (S/N: 9WK723-UP)					
Hydraulic Oil Filter.....	HC-5505				
Hydraulic Oil Filter.....	H-5505				



ENGINE APPLICATION

MODEL/APPLICATION	SAKURA NO	MODEL/APPLICATION	SAKURA NO	MODEL/APPLICATION	SAKURA NO
CATERPILLAR		CATERPILLAR		CATERPILLAR	
320C (EXCAVATORS) CAT 3066 (S/N: BDC1-UP) Hydraulic Oil Filter.....	HC-5801	320C (EXCAVATORS) CAT 3066 (S/N: JTG1-UP) Hydraulic Oil Filter.....	HC-5801 H-5522	320C L (EXCAVATORS) CAT 3066 (S/N: BDC1-UP) Hydraulic Oil Filter.....	HC-5801 H-7942
320C (EXCAVATORS) CAT 3066 (S/N: BDE1-UP) Hydraulic Oil Filter.....	HC-5801 H-7942	320C (EXCAVATORS) CAT 3066 (S/N: MAB1-UP) Hydraulic Oil Filter.....	HC-5801 H-7942	320C L (EXCAVATORS) CAT 3066 (S/N: BDE1-UP) Hydraulic Oil Filter.....	H-7942 HC-5801
320C (EXCAVATORS) CAT 3066 (S/N: BEA1-UP) Hydraulic Oil Filter.....	H-7942 HC-5801	320C (EXCAVATORS) CAT 3066 (S/N: MAC1-UP) Hydraulic Oil Filter.....	H-7942 HC-5801	320C L (EXCAVATORS) CAT 3066 (S/N: BEA1-UP) Hydraulic Oil Filter.....	H-7942 HC-5801
320C (EXCAVATORS) CAT 3066 (S/N: BEF1-UP) Hydraulic Oil Filter.....	H-7942 HC-5801	320C (EXCAVATORS) CAT 3066 (S/N: PAB1-UP) Hydraulic Oil Filter.....	HC-5801 H-7942	320C L (EXCAVATORS) CAT 3066 (S/N: BEF1-UP) Hydraulic Oil Filter.....	HC-5801 H-7942
320C (EXCAVATORS) CAT 3066 (S/N: BER1-UP) Hydraulic Oil Filter.....	HC-5801 H-7942	320C (EXCAVATORS) CAT 3066 (S/N: PAC1-UP) Hydraulic Oil Filter.....	H-7942 HC-5801	320C L (EXCAVATORS) CAT 3066 (S/N: BER1-UP) Hydraulic Oil Filter.....	H-7942 HC-5801
320C (EXCAVATORS) CAT 3066 (S/N: BPR1-UP) Hydraulic Oil Filter.....	H-7942 HC-5801	320C (EXCAVATORS) CAT 3066 (S/N: RAW1-UP) Hydraulic Oil Filter.....	HC-5801 H-7942	320C L (EXCAVATORS) CAT 3066 (S/N: BPR1-UP) Hydraulic Oil Filter.....	HC-5801 H-7942
320C (EXCAVATORS) CAT 3066 (S/N: BRX1-UP) Hydraulic Oil Filter.....	H-7942 HC-5801	320C (EXCAVATORS) CAT 3066 (S/N: SBN1-UP) Hydraulic Oil Filter.....	H-7942 HC-5801	320C L (EXCAVATORS) CAT 3066 (S/N: BRX1-UP) Hydraulic Oil Filter.....	H-7942 HC-5801
320C (EXCAVATORS) CAT 3066 (S/N: CLM1-UP) Hydraulic Oil Filter.....	H-7942 HC-5801	320C (FOREST EQUIPMENTS) CAT 3066 (S/N: BGB1-UP) Hydraulic Oil Filter.....	HC-5801 H-7942	320C LN (EXCAVATORS) CAT 3066 (S/N: BCN1-UP) Hydraulic Oil Filter.....	HC-5801 H-7942
320C (EXCAVATORS) CAT 3066 (S/N: CLZ1-UP) Hydraulic Oil Filter.....	H-7942 HC-5801	320C (FOREST EQUIPMENTS) CAT 3066 (S/N: BKK1-UP) Hydraulic Oil Filter.....	HC-5801 H-7942	320C LN (EXCAVATORS) CAT 3066 (S/N: BDE1-UP) Hydraulic Oil Filter.....	HC-5801 H-7942
320C (EXCAVATORS) CAT 3066 (S/N: DBG1-UP) Hydraulic Oil Filter.....	H-5522 HC-5801	320C L (EXCAVATORS) CAT 3066 (S/N: AMC1-UP) Hydraulic Oil Filter.....	HC-5801 H-7942	320C LN (EXCAVATORS) CAT 3066 (S/N: BEA1-UP) Hydraulic Oil Filter.....	HC-5801 H-7942
320C (EXCAVATORS) CAT 3066 (S/N: EGA1-UP) Hydraulic Oil Filter.....	HC-5801 H-5522	320C L (EXCAVATORS) CAT 3066 (S/N: ANB1-UP) Hydraulic Oil Filter.....	H-7942 HC-5801	320C LU (EXCAVATORS) CAT 3066 (S/N: CLM1-UP) Hydraulic Oil Filter.....	H-7942 HC-5801
320C (EXCAVATORS) CAT 3066 (S/N: EGL1-09999-UP) Hydraulic Oil Filter.....	HC-5801 H-5522	320C L (EXCAVATORS) CAT 3066 (S/N: BBC1-UP) Hydraulic Oil Filter.....	H-7942 HC-5801	320C LU (EXCAVATORS) CAT 3066 (S/N: CLZ1-UP) Hydraulic Oil Filter.....	HC-5801 H-7942
320C (EXCAVATORS) CAT 3066 (S/N: GLA1-UP) Hydraulic Oil Filter.....	HC-5801 H-5522	320C L (EXCAVATORS) CAT 3066 (S/N: BCN1-UP) Hydraulic Oil Filter.....	H-7942 HC-5801	320C U (EXCAVATORS) CAT 3066 (S/N: CLM1-UP) Hydraulic Oil Filter.....	H-7942 HC-5801



ENGINE APPLICATION

MODEL/APPLICATION	SAKURA NO	MODEL/APPLICATION	SAKURA NO	MODEL/APPLICATION	SAKURA NO
CATERPILLAR		CATERPILLAR		CATERPILLAR	
320C U (EXCAVATORS) CAT 3066 (S/N: CLZ1-UP)		320B N (EXCAVATORS) CAT 3066 (S/N: 4NR1-UP)		320C FM (FOREST EQUIPMENTS) CAT 3066 (S/N: TBR1-UP)	
Hydraulic Oil Filter.....	HC-5801	Hydraulic Oil Filter.....	HC-5505	Hydraulic Oil Filter.....	H-7942
Hydraulic Oil Filter.....	H-7942	Hydraulic Oil Filter.....	H-7942	Hydraulic Oil Filter.....	HC-5801
320 BLM (EXCAVATORS)		320B S (EXCAVATORS) CAT 3116 (S/N: 1XS1-UP)		320C MH (MATERIAL HANDLERS) CAT 3066 (S/N: EGA1-UP)	
Hydraulic Oil Filter.....	HC-5505	Hydraulic Oil Filter.....	HC-5801	Hydraulic Oil Filter.....	HC-5801
Hydraulic Oil Filter.....	HC-5801	Hydraulic Oil Filter.....	H-7942	Hydraulic Oil Filter.....	H-5522
Hydraulic Oil Filter.....	H-7942	Hydraulic Oil Filter.....	HC-5505	320C MH (MATERIAL HANDLERS) CAT 3066 (S/N: JPL1-09999-UP)	
320B LN (EXCAVATORS) CAT 3066 (S/N: 1XS1-UP)		320B S (EXCAVATORS) CAT 3116 (S/N: 2AS1-UP)		Hydraulic Oil Filter..... HC-5801 Hydraulic Oil Filter..... H-5522	
Hydraulic Oil Filter.....	HC-5505	Hydraulic Oil Filter.....	HC-5505	320C S (EXCAVATORS) CAT 3066 (S/N: EGL1-UP)	
Hydraulic Oil Filter.....	HC-5801	Hydraulic Oil Filter.....	HC-5801	Hydraulic Oil Filter.....	H-5522
Hydraulic Oil Filter.....	H-7942	Hydraulic Oil Filter.....	H-7942	Hydraulic Oil Filter.....	HC-5801
320B LN (EXCAVATORS) CAT 3066 (S/N: 2AS1-UP)		320B S (EXCAVATORS) CAT 3116 (S/N: 3YZ1-UP)		320L (EXCAVATORS) CAT 3116 (S/N: 1KL1-UP)	
Hydraulic Oil Filter.....	HC-5801	Hydraulic Oil Filter.....	H-7942	Hydraulic Oil Filter.....	HC-5801
Hydraulic Oil Filter.....	HC-5505	Hydraulic Oil Filter.....	HC-5801	Hydraulic Oil Filter.....	H-5505
Hydraulic Oil Filter.....	H-7942	Hydraulic Oil Filter.....	HC-5505	Hydraulic Oil Filter.....	HC-5505
320B LN (EXCAVATORS) CAT 3066 (S/N: 3YZ1-UP)		320B S (EXCAVATORS) CAT 3116 (S/N: 5MS1-UP)		320L (EXCAVATORS) CAT 3116 (S/N: 3XK1-UP)	
Hydraulic Oil Filter.....	H-7942	Hydraulic Oil Filter.....	H-7942	Hydraulic Oil Filter.....	H-5505
Hydraulic Oil Filter.....	HC-5505	Hydraulic Oil Filter.....	HC-5801	Hydraulic Oil Filter.....	HC-5505
Hydraulic Oil Filter.....	HC-5801	Hydraulic Oil Filter.....	HC-5505	320L (EXCAVATORS) CAT 3116 (S/N: 4ZJ1-459-UP)	
320B LN (EXCAVATORS) CAT 3066 (S/N: 5MS1-UP)		320B S (EXCAVATORS) CAT 3116 (S/N: 6LW1-UP)		Hydraulic Oil Filter..... H-5505 Hydraulic Oil Filter..... HC-5505	
Hydraulic Oil Filter.....	H-7942	Hydraulic Oil Filter.....	HC-5505	320L (EXCAVATORS) CAT 3116 (S/N: 4ZJ460-UP)	
Hydraulic Oil Filter.....	HC-5801	Hydraulic Oil Filter.....	HC-5801	Hydraulic Oil Filter.....	H-5505
Hydraulic Oil Filter.....	HC-5505	Hydraulic Oil Filter.....	H-7942	Hydraulic Oil Filter.....	HC-5505
320B LN (EXCAVATORS) CAT 3066 (S/N: 6LW1-UP)		320B S (EXCAVATORS) CAT 3116 (S/N: 7JR1-UP)		320L (EXCAVATORS) CAT 3116 (S/N: 6KM1-UP)	
Hydraulic Oil Filter.....	HC-5505	Hydraulic Oil Filter.....	HC-5505	Hydraulic Oil Filter.....	H-5505
Hydraulic Oil Filter.....	H-7942	Hydraulic Oil Filter.....	H-7942	Hydraulic Oil Filter.....	HC-5505
Hydraulic Oil Filter.....	HC-5801	Hydraulic Oil Filter.....	HC-5801	320L (EXCAVATORS) CAT 3116 (S/N: 7WK1-UP)	
320B LN (EXCAVATORS) CAT 3066 (S/N: 7JR1-UP)		320B S (EXCAVATORS) CAT 3116 (S/N: 9WS1-UP)		Hydraulic Oil Filter..... HC-5505 Hydraulic Oil Filter..... H-5505	
Hydraulic Oil Filter.....	HC-5801	Hydraulic Oil Filter.....	HC-5801	320L (EXCAVATORS) CAT 3116 (S/N: 8LK1-UP)	
Hydraulic Oil Filter.....	H-7942	Hydraulic Oil Filter.....	H-7942	Hydraulic Oil Filter.....	HC-5801
Hydraulic Oil Filter.....	HC-5505	Hydraulic Oil Filter.....	HC-5505	Hydraulic Oil Filter.....	H-5505
320B LN (EXCAVATORS) CAT 3066 (S/N: 9WS1-UP)		320B U (EXCAVATORS) CAT 3066 (S/N: BAN1-UP)		320L (EXCAVATORS) CAT 3116 (S/N: 9WG1-722-UP)	
Hydraulic Oil Filter.....	H-7942	Hydraulic Oil Filter.....	H-5505	Hydraulic Oil Filter.....	H-5505
Hydraulic Oil Filter.....	HC-5801	Hydraulic Oil Filter.....	HC-5505	Hydraulic Oil Filter.....	HC-5505
Hydraulic Oil Filter.....	HC-5505	320B U (EXCAVATORS) CAT 3066 (S/N: BBG1-UP)		320L (EXCAVATORS) CAT 3116 (S/N: 9WG723-UP)	
320B LU (EXCAVATORS) CAT 3066 (S/N: BAN1-UP)		320C FM (FOREST EQUIPMENTS) CAT 3066 (S/N: SAH1-UP)		Hydraulic Oil Filter..... H-5505 Hydraulic Oil Filter..... HC-5505	
Hydraulic Oil Filter.....	H-5505	Hydraulic Oil Filter.....	H-7942	320L (EXCAVATORS) CAT 3116 (S/N: 9WG723-UP)	
Hydraulic Oil Filter.....	HC-5505	Hydraulic Oil Filter.....	HC-5801	Hydraulic Oil Filter..... HC-5505	
320B LU (EXCAVATORS) CAT 3066 (S/N: BBG1-UP)				320L (EXCAVATORS) CAT 3116 (S/N: 9WG723-UP)	
Hydraulic Oil Filter.....	H-5505			Hydraulic Oil Filter..... HC-5505	
Hydraulic Oil Filter.....	HC-5505			Hydraulic Oil Filter..... HC-5505	



ENGINE APPLICATION

MODEL/APPLICATION	SAKURA NO	MODEL/APPLICATION	SAKURA NO	MODEL/APPLICATION	SAKURA NO
CATERPILLAR		CATERPILLAR		CATERPILLAR	
320L (EXCAVATORS) CAT 3116 (S/N: 9WG723-UP)		Hydraulic Oil Filter.....	HC-5801	Hydraulic Oil Filter.....	HC-5801
Hydraulic Oil Filter.....	H-5505	322C (EXCAVATORS) CAT 3126 (S/N: EMR1-UP)		322C LN (EXCAVATORS) CAT 3054 (S/N: BGR1-UP)	
320N (EXCAVATORS) S/N: 3XK822-UP		Hydraulic Oil Filter.....	HC-5801	Hydraulic Oil Filter.....	H-7942
Hydraulic Oil Filter.....	HC-5505	Hydraulic Oil Filter.....	H-5522	Hydraulic Oil Filter.....	HC-5801
Hydraulic Oil Filter.....	H-5505	Hydraulic Oil Filter.....	H-7942	322B (EXCAVATORS) CAT 3116 (S/N: 2ES1-UP)	
Hydraulic Oil Filter.....	HC-55170	322C (EXCAVATORS) CAT 3126 (S/N: HEK1-UP)		Hydraulic Oil Filter.....	HC-5801
320N (EXCAVATORS) S/N: 9WG1-UP		Hydraulic Oil Filter.....	HC-5801	322B (EXCAVATORS) CAT 3116 (S/N: 8MR1-UP)	
Hydraulic Oil Filter.....	H-5505	Hydraulic Oil Filter.....	H-7942	Hydraulic Oil Filter.....	HC-5801
320D2 (EXCAVATORS) C7.1		Hydraulic Oil Filter.....	HC-55170	Hydraulic Oil Filter.....	H-7942
Hydraulic Oil Filter.....	EH-55040	322C (EXCAVATORS) CAT 3126 (S/N: MAR1-UP)		Hydraulic Oil Filter.....	HC-5505
320D2 (EXCAVATORS) C7.1 ACERT		Hydraulic Oil Filter.....	HC-5801	322B (EXCAVATORS) CAT 3116 (S/N: 8NR1-UP)	
Hydraulic Oil Filter.....	EH-55040	Hydraulic Oil Filter.....	H-7942	Hydraulic Oil Filter.....	HC-5801
321C (EXCAVATORS) CAT 3066 (S/N: MCF1-UP)		Hydraulic Oil Filter.....	H-5522	Hydraulic Oil Filter.....	HC-5505
Hydraulic Oil Filter.....	HC-5801	322C (FOREST EQUIPMENTS) CAT 3126 (S/N: BPH1-UP)		Hydraulic Oil Filter.....	H-7942
Hydraulic Oil Filter.....	H-7942	Hydraulic Oil Filter.....	HC-5801	322L (EXCAVATORS) CAT 3116 (S/N: 4RM1-UP)	
321C LCR (SHOVELS) CAT 3066T , 2004-UP		Hydraulic Oil Filter.....	H-7942	Hydraulic Oil Filter.....	HC-5505
Hydraulic Oil Filter.....	HC-5801	322C (FOREST EQUIPMENTS) CAT 3126 (S/N: CAM1-UP)		Hydraulic Oil Filter.....	H-5505
322C (EXCAVATORS) CAT 3126 (S/N: BFK1-UP)		Hydraulic Oil Filter.....	HC-5801	322L (EXCAVATORS) CAT 3116 (S/N: 7WL1-UP)	
Hydraulic Oil Filter.....	HC-5801	Hydraulic Oil Filter.....	H-7942	Hydraulic Oil Filter.....	HC-5505
Hydraulic Oil Filter.....	H-7942	322C (FOREST EQUIPMENTS) S/N: BYL1-UP		Hydraulic Oil Filter.....	H-5505
322C (EXCAVATORS) CAT 3126 (S/N: BGR1-UP)		Hydraulic Oil Filter.....	HC-5801	322L (EXCAVATORS) CAT 3116 (S/N: 8CL1-UP)	
Hydraulic Oil Filter.....	H-7942	Hydraulic Oil Filter.....	H-7942	Hydraulic Oil Filter.....	HC-5505
Hydraulic Oil Filter.....	HC-5801	Hydraulic Oil Filter.....	HC-55170	Hydraulic Oil Filter.....	H-5505
322C (EXCAVATORS) CAT 3126 (S/N: BKJ1-UP)		322C L (EXCAVATORS) CAT 3054 (S/N: BKJ1-UP)		322L (EXCAVATORS) CAT 3116 (S/N: 8ML1-UP)	
Hydraulic Oil Filter.....	H-7942	Hydraulic Oil Filter.....	HC-55170	Hydraulic Oil Filter.....	HC-5505
Hydraulic Oil Filter.....	HC-5801	Hydraulic Oil Filter.....	HC-5801	Hydraulic Oil Filter.....	H-5505
Hydraulic Oil Filter.....	HC-55170	Hydraulic Oil Filter.....	H-7942	322L (EXCAVATORS) CAT 3116 (S/N: 9JL1-UP)	
322C (EXCAVATORS) CAT 3126 (S/N: BKM1-UP)		322C L (EXCAVATORS) CAT 3054 (S/N: BLM1-UP)		Hydraulic Oil Filter.....	HC-5505
Hydraulic Oil Filter.....	H-7942	Hydraulic Oil Filter.....	H-7942	Hydraulic Oil Filter.....	H-5505
Hydraulic Oil Filter.....	HC-5801	Hydraulic Oil Filter.....	HC-5801	322L (EXCAVATORS) CAT 3116 (S/N: 9RL1-UP)	
Hydraulic Oil Filter.....	HC-55170	Hydraulic Oil Filter.....	H-7942	Hydraulic Oil Filter.....	HC-5505
322C (EXCAVATORS) CAT 3126 (S/N: BLP1-UP)		Hydraulic Oil Filter.....	HC-5801	Hydraulic Oil Filter.....	H-5505
Hydraulic Oil Filter.....	H-7942	322C L (EXCAVATORS) CAT 3054 (S/N: FED1-UP)		322 LN (EXCAVATORS) CAT 3116 (S/N: 4RM1-UP)	
Hydraulic Oil Filter.....	HC-5801	Hydraulic Oil Filter.....	H-7942	Hydraulic Oil Filter.....	H-5505
Hydraulic Oil Filter.....	HC-5801	Hydraulic Oil Filter.....	HC-5801	Hydraulic Oil Filter.....	HC-5505
322C (EXCAVATORS) CAT 3126 (S/N: CBY1-UP)		322C L (EXCAVATORS) S/N: EMR0297-UP , 2004-UP		322 LN (EXCAVATORS) CAT 3116 (S/N: 8ML1-UP)	
Hydraulic Oil Filter.....	HC-5801	Hydraulic Oil Filter.....	HC-5801	Hydraulic Oil Filter.....	H-5505
Hydraulic Oil Filter.....	H-7942	Hydraulic Oil Filter.....	H-5522	Hydraulic Oil Filter.....	HC-5505
322C (EXCAVATORS) CAT 3126 (S/N: DAA1-UP)		322C LN (EXCAVATORS) CAT 3054 (S/N: BFK1-UP)		322 LN (EXCAVATORS) CAT 3116 (S/N: 9JL1-UP)	
Hydraulic Oil Filter.....	H-7942	Hydraulic Oil Filter.....	H-7942	Hydraulic Oil Filter.....	H-5505



ENGINE APPLICATION

MODEL/APPLICATION	SAKURA NO	MODEL/APPLICATION	SAKURA NO	MODEL/APPLICATION	SAKURA NO
CATERPILLAR		CATERPILLAR		CATERPILLAR	
322 LN (EXCAVATORS) CAT 3116 (S/N: 9JL1-UP)		322C FP (FOREST EQUIPMENTS) CAT 3054 (S/N: C3R1-UP)		Hydraulic Oil Filter.....	HC-55170
Hydraulic Oil Filter.....	HC-5505	Hydraulic Oil Filter.....	HC-5801	Hydraulic Oil Filter.....	H-5522
322B L (EXCAVATORS) CAT 3054 (S/N: 1YS1-UP)		Hydraulic Oil Filter.....	HC-55170	324D (EXCAVATORS) CAT S/N: C7C1-UP , 2006-UP	
Hydraulic Oil Filter.....	HC-5505	Hydraulic Oil Filter.....	H-7942	Hydraulic Oil Filter.....	HC-5801
Hydraulic Oil Filter.....	HC-5801	322C FP (FOREST EQUIPMENTS) CAT 3054 (S/N: LAR1-UP)		Hydraulic Oil Filter.....	H-5522
322B L (EXCAVATORS) CAT 3116 (S/N: 1AS1-UP)		Hydraulic Oil Filter.....	HC-55170	Hydraulic Oil Filter.....	HC-55170
Hydraulic Oil Filter.....	H-7942	Hydraulic Oil Filter.....	H-7942	324D (EXCAVATORS) CAT S/N: CJX1-UP , 2006-UP	
Hydraulic Oil Filter.....	HC-5505	Hydraulic Oil Filter.....	HC-5801	Hydraulic Oil Filter.....	H-5522
Hydraulic Oil Filter.....	HC-5801	322C FP (FOREST EQUIPMENTS) CAT 3054 (S/N: M2H1-UP)		Hydraulic Oil Filter.....	HC-5801
322B L (EXCAVATORS) CAT 3116 (S/N: 1ES1-UP)		Hydraulic Oil Filter.....	HC-5801	324D (EXCAVATORS) CAT S/N: DFP1-UP , 2006-UP	
Hydraulic Oil Filter.....	H-7942	Hydraulic Oil Filter.....	H-7942	Hydraulic Oil Filter.....	HC-5801
Hydraulic Oil Filter.....	HC-5801	322D (EXCAVATORS) S/N: BYM1-UP		Hydraulic Oil Filter.....	HC-55170
Hydraulic Oil Filter.....	HC-5505	Hydraulic Oil Filter.....	HC-55170	324D (EXCAVATORS) CAT S/N: EJC1-UP , 2006-UP	
322B L (EXCAVATORS) CAT 3116 (S/N: 1YS1-UP)		Hydraulic Oil Filter.....	HC-5801	Hydraulic Oil Filter.....	H-5522
Hydraulic Oil Filter.....	HC-5505	Hydraulic Oil Filter.....	HC-5801	Hydraulic Oil Filter.....	HC-55170
Hydraulic Oil Filter.....	HC-5801	322D (EXCAVATORS) S/N: CYD1-UP		Hydraulic Oil Filter.....	HC-5801
Hydraulic Oil Filter.....	H-7942	Hydraulic Oil Filter.....	HC-55170	324D (EXCAVATORS) CAT S/N: JGK1-UP , 2006-UP	
322B L (EXCAVATORS) CAT 3116 (S/N: 1ZS1-UP)		Hydraulic Oil Filter.....	H-5522	Hydraulic Oil Filter.....	HC-55170
Hydraulic Oil Filter.....	HC-5505	Hydraulic Oil Filter.....	HC-5801	Hydraulic Oil Filter.....	HC-5801
Hydraulic Oil Filter.....	H-7942	322D (EXCAVATORS) S/N: DKW1-UP		324D (EXCAVATORS) CAT S/N: JJG1-384-UP , 2006-UP	
Hydraulic Oil Filter.....	HC-5801	Hydraulic Oil Filter.....	HC-55170	Hydraulic Oil Filter.....	HC-5801
322B L (EXCAVATORS) CAT 3116 (S/N: 2ES1-UP)		Hydraulic Oil Filter.....	HC-5801	Hydraulic Oil Filter.....	HC-55170
Hydraulic Oil Filter.....	HC-5505	Hydraulic Oil Filter.....	H-5522	Hydraulic Oil Filter.....	H-5522
Hydraulic Oil Filter.....	H-7942	322D (EXCAVATORS) S/N: JLG1-UP		324D (EXCAVATORS) CAT S/N: JJG385-UP , 2006-UP	
Hydraulic Oil Filter.....	HC-5801	Hydraulic Oil Filter.....	HC-5801	Hydraulic Oil Filter.....	H-5522
322B L (EXCAVATORS) CAT 3116 (S/N: 8MR1-UP)		Hydraulic Oil Filter.....	HC-55170	Hydraulic Oil Filter.....	HC-5801
Hydraulic Oil Filter.....	H-7942	Hydraulic Oil Filter.....	HC-55170	324D (EXCAVATORS) CAT S/N: JKR1-178-UP , 2006-UP	
Hydraulic Oil Filter.....	HC-5801	Hydraulic Oil Filter.....	H-5522	Hydraulic Oil Filter.....	HC-55170
Hydraulic Oil Filter.....	HC-5505	322D (EXCAVATORS) S/N: PBM1-UP		Hydraulic Oil Filter.....	HC-5801
322B L (EXCAVATORS) CAT 3116 (S/N: 8NR1-UP)		Hydraulic Oil Filter.....	HC-5801	324D (EXCAVATORS) CAT S/N: JKR179-UP , 2006-UP	
Hydraulic Oil Filter.....	HC-5801	Hydraulic Oil Filter.....	HC-55170	Hydraulic Oil Filter.....	H-5522
Hydraulic Oil Filter.....	HC-5505	Hydraulic Oil Filter.....	H-5522	Hydraulic Oil Filter.....	HC-5801
Hydraulic Oil Filter.....	H-7942	322D (EXCAVATORS) S/N: RAC1-UP		324D (EXCAVATORS) CAT S/N: JLS1-174-UP , 2006-UP	
322B LN (EXCAVATORS) CAT 3116 (S/N: 1ZS1-UP)		Hydraulic Oil Filter.....	HC-55170	Hydraulic Oil Filter.....	HC-5801
Hydraulic Oil Filter.....	H-7942	Hydraulic Oil Filter.....	HC-5801	Hydraulic Oil Filter.....	HC-55170
Hydraulic Oil Filter.....	HC-5801	Hydraulic Oil Filter.....	H-5522	Hydraulic Oil Filter.....	H-5522
Hydraulic Oil Filter.....	HC-5505	322D (EXCAVATORS) S/N: SDC1-UP		Hydraulic Oil Filter.....	HC-5801
Hydraulic Oil Filter.....	H-7942	Hydraulic Oil Filter.....	HC-55170	324D (EXCAVATORS) CAT S/N: JLS175-UP , 2006-UP	
322B LN (EXCAVATORS) CAT 3116 (S/N: 2ES1-UP)		Hydraulic Oil Filter.....	HC-5801	Hydraulic Oil Filter.....	HC-5801
Hydraulic Oil Filter.....	HC-5801	Hydraulic Oil Filter.....	HC-5801	Hydraulic Oil Filter.....	HC-55170
Hydraulic Oil Filter.....	HC-5505	Hydraulic Oil Filter.....	H-5522	Hydraulic Oil Filter.....	H-5522
Hydraulic Oil Filter.....	H-7942	322D (EXCAVATORS) S/N: SED1-UP		Hydraulic Oil Filter.....	HC-5801
Hydraulic Oil Filter.....	HC-5801	Hydraulic Oil Filter.....	HC-55170	324D (EXCAVATORS) CAT S/N: JLS175-UP , 2006-UP	
Hydraulic Oil Filter.....	HC-5505	Hydraulic Oil Filter.....	H-5522	Hydraulic Oil Filter.....	HC-5801
Hydraulic Oil Filter.....	H-7942	Hydraulic Oil Filter.....	HC-5801	Hydraulic Oil Filter.....	HC-5801



ENGINE APPLICATION

MODEL/APPLICATION	SAKURA NO	MODEL/APPLICATION	SAKURA NO	MODEL/APPLICATION	SAKURA NO
CATERPILLAR		CATERPILLAR		CATERPILLAR	
325B L (EXCAVATORS) CAT 3116 (S/N: 6DN1-UP) Hydraulic Oil Filter.....	H-7942	Hydraulic Oil Filter.....	H-5522	325L (EXCAVATORS) CAT 3116 (S/N: 25K1-UP) Hydraulic Oil Filter.....	HC-5505
325B L (EXCAVATORS) CAT 3116 (S/N: 8FN1-UP) Hydraulic Oil Filter.....	H-7942	Hydraulic Oil Filter.....	HC-5801	Hydraulic Oil Filter.....	H-5505
Hydraulic Oil Filter.....	HC-5801	325C (EXCAVATORS) CAT 3126 (S/N: CSJ1-UP) Hydraulic Oil Filter.....	HC-5801	325L (EXCAVATORS) CAT 3116 (S/N: 25L1-UP) Hydraulic Oil Filter.....	H-5505
Hydraulic Oil Filter.....	HC-5505	Hydraulic Oil Filter.....	H-5522	Hydraulic Oil Filter.....	HC-5505
325B L (EXCAVATORS) CAT 3116 (S/N: 8PR1-UP) Hydraulic Oil Filter.....	HC-5505	325C (EXCAVATORS) CAT 3126 (S/N: DTF1-UP) Hydraulic Oil Filter.....	HC-5801	325L (EXCAVATORS) CAT 3116 (S/N: 3LL1-UP) Hydraulic Oil Filter.....	H-5505
Hydraulic Oil Filter.....	HC-5801	Hydraulic Oil Filter.....	H-5522	Hydraulic Oil Filter.....	HC-5505
Hydraulic Oil Filter.....	H-7942	325C (EXCAVATORS) CAT 3126 (S/N: JLC1-UP) Hydraulic Oil Filter.....	HC-5801	325L (EXCAVATORS) CAT 3116 (S/N: 5WK1-UP) Hydraulic Oil Filter.....	H-5505
325B L (EXCAVATORS) CAT 3116 (S/N: 8RR1-UP) Hydraulic Oil Filter.....	HC-5801	Hydraulic Oil Filter.....	H-5522	Hydraulic Oil Filter.....	HC-5505
Hydraulic Oil Filter.....	H-7942	325C (EXCAVATORS) CAT 3126 (S/N: JLD1-UP) Hydraulic Oil Filter.....	H-5522	325L (EXCAVATORS) CAT 3116 (S/N: 6KK1-UP) Hydraulic Oil Filter.....	HC-5505
Hydraulic Oil Filter.....	HC-5505	Hydraulic Oil Filter.....	HC-5801	Hydraulic Oil Filter.....	H-5505
325C (EXCAVATORS) CAT 3126 (S/N: AMH1-UP) Hydraulic Oil Filter.....	HC-5801	325C (EXCAVATORS) CAT 3126 (S/N: S2C1-UP) Hydraulic Oil Filter.....	HC-55170	325L (EXCAVATORS) CAT 3116 (S/N: 6RM1-UP) Hydraulic Oil Filter.....	HC-5505
Hydraulic Oil Filter.....	HC-55170	Hydraulic Oil Filter.....	H-7942	Hydraulic Oil Filter.....	H-5505
Hydraulic Oil Filter.....	H-7942	325C L (EXCAVATORS) CAT 3116 (S/N: BFE1-UP) Hydraulic Oil Filter.....	H-7942	325L (EXCAVATORS) CAT 3116 (S/N: 7CJ1-UP) Hydraulic Oil Filter.....	HC-5505
325C (EXCAVATORS) CAT 3126 (S/N: BFE1-474-UP) Hydraulic Oil Filter.....	HC-5801	Hydraulic Oil Filter.....	HC-55170	Hydraulic Oil Filter.....	H-5505
Hydraulic Oil Filter.....	HC-55170	Hydraulic Oil Filter.....	HC-5801	325L (EXCAVATORS) CAT 3116 (S/N: 7LJ1-UP) Hydraulic Oil Filter.....	H-5505
Hydraulic Oil Filter.....	H-7942	325C L (EXCAVATORS) CAT 3126 (S/N: BKW1-UP) Hydraulic Oil Filter.....	H-7942	Hydraulic Oil Filter.....	HC-5505
325C (EXCAVATORS) CAT 3126 (S/N: BFE1-UP) Hydraulic Oil Filter.....	HC-55170	Hydraulic Oil Filter.....	HC-5801	325L (EXCAVATORS) CAT 3116 (S/N: 7LM1-UP) Hydraulic Oil Filter.....	H-5505
Hydraulic Oil Filter.....	H-7942	325C L (EXCAVATORS) CAT 3126 (S/N: BMM1-UP) Hydraulic Oil Filter.....	H-7942	Hydraulic Oil Filter.....	HC-5505
Hydraulic Oil Filter.....	HC-5801	Hydraulic Oil Filter.....	HC-5801	325L (EXCAVATORS) CAT 3116 (S/N: 7TG1-UP) Hydraulic Oil Filter.....	H-5505
325C (EXCAVATORS) CAT 3126 (S/N: BKW1-UP) Hydraulic Oil Filter.....	HC-5801	325C L (EXCAVATORS) CAT 3126 (S/N: CRB1-UP) Hydraulic Oil Filter.....	HC-5801	Hydraulic Oil Filter.....	H-5505
Hydraulic Oil Filter.....	H-7942	Hydraulic Oil Filter.....	H-7942	325L (EXCAVATORS) CAT 3116 (S/N: 8JG1-UP) Hydraulic Oil Filter.....	H-5505
Hydraulic Oil Filter.....	HC-5801	325C L (EXCAVATORS) CAT 3126 (S/N: CRB1-UP) Hydraulic Oil Filter.....	HC-5801	Hydraulic Oil Filter.....	HC-5505
325C (EXCAVATORS) CAT 3126 (S/N: BFE475-UP) Hydraulic Oil Filter.....	HC-55170	Hydraulic Oil Filter.....	H-7942	325L (EXCAVATORS) CAT 3116 (S/N: 8N1-UP) Hydraulic Oil Filter.....	H-5505
Hydraulic Oil Filter.....	H-7942	325C L (EXCAVATORS) CAT 3126 (S/N: CRB1-UP) Hydraulic Oil Filter.....	HC-5801	Hydraulic Oil Filter.....	HC-5505
Hydraulic Oil Filter.....	HC-5801	Hydraulic Oil Filter.....	H-7942	325L (EXCAVATORS) CAT 3116 (S/N: 8NL1-UP) Hydraulic Oil Filter.....	H-5505
325C (EXCAVATORS) CAT 3126 (S/N: BMM1-UP) Hydraulic Oil Filter.....	H-7942	325C LN (EXCAVATORS) CAT 3116 (S/N: CRB1-UP) Hydraulic Oil Filter.....	H-7942	Hydraulic Oil Filter.....	HC-5505
Hydraulic Oil Filter.....	HC-5801	Hydraulic Oil Filter.....	HC-5801	325L (EXCAVATORS) CAT 3116 (S/N: 8NK1-UP) Hydraulic Oil Filter.....	H-5505
Hydraulic Oil Filter.....	HC-5801	325L (EXCAVATORS) CAT 3116 (S/N: 2JK1-UP) Hydraulic Oil Filter.....	HC-5505	Hydraulic Oil Filter.....	H-5505
325C (EXCAVATORS) CAT 3126 (S/N: BTD1-UP) Hydraulic Oil Filter.....	H-7942	Hydraulic Oil Filter.....	H-5505	325L (EXCAVATORS) CAT 3116 (S/N: 8NL1-UP) Hydraulic Oil Filter.....	HC-5505
Hydraulic Oil Filter.....	HC-5801	325L (EXCAVATORS) CAT 3116 (S/N: 2JK1-UP) Hydraulic Oil Filter.....	HC-5505	Hydraulic Oil Filter.....	HC-5505
Hydraulic Oil Filter.....	HC-55170	Hydraulic Oil Filter.....	H-5505		
325C (EXCAVATORS) CAT 3126 (S/N: CRB1-UP) Hydraulic Oil Filter.....					



ENGINE APPLICATION

MODEL/APPLICATION	SAKURA NO
CATERPILLAR	
325L (EXCAVATORS) CAT 3116 (S/N: 8YK1-UP)	
Hydraulic Oil Filter.....	H-5505
Hydraulic Oil Filter.....	HC-5505
325L (EXCAVATORS) CAT 3116 (S/N: 9KL1-UP)	
Hydraulic Oil Filter.....	H-5505
Hydraulic Oil Filter.....	HC-5505
325L (EXCAVATORS) CAT 3116 (S/N: 9SG1-UP)	
Hydraulic Oil Filter.....	HC-5505
Hydraulic Oil Filter.....	H-5505
325L (EXCAVATORS) CAT 3116 (S/N: 9ZK1-UP)	
Hydraulic Oil Filter.....	HC-5505
Hydraulic Oil Filter.....	H-5505
325D (EXCAVATORS) S/N: A3R1-504-UP	
Hydraulic Oil Filter.....	H-5522
Hydraulic Oil Filter.....	HC-5801
Hydraulic Oil Filter.....	HC-55170
325D (EXCAVATORS) S/N: A3R505-UP	
Hydraulic Oil Filter.....	H-5522
Hydraulic Oil Filter.....	HC-55170
Hydraulic Oil Filter.....	HC-5801
325D (EXCAVATORS) S/N: AZP1-UP	
Hydraulic Oil Filter.....	HC-5801
Hydraulic Oil Filter.....	HC-55170
Hydraulic Oil Filter.....	H-5522
325D (EXCAVATORS) S/N: C4H1-209-UP	
Hydraulic Oil Filter.....	H-5522
Hydraulic Oil Filter.....	HC-5801
Hydraulic Oil Filter.....	HC-55170
325D (EXCAVATORS) S/N: C4H210-UP	
Hydraulic Oil Filter.....	H-5522
Hydraulic Oil Filter.....	HC-55170
Hydraulic Oil Filter.....	HC-5801
325D (EXCAVATORS) S/N: C7K1-200-UP	
Hydraulic Oil Filter.....	HC-5801
Hydraulic Oil Filter.....	H-5522
Hydraulic Oil Filter.....	HC-55170
325D (EXCAVATORS) S/N: C8L1-166-UP	
Hydraulic Oil Filter.....	HC-55170
Hydraulic Oil Filter.....	HC-5801
Hydraulic Oil Filter.....	H-5522
325D (EXCAVATORS) S/N: C8L167-UP	

MODEL/APPLICATION	SAKURA NO
CATERPILLAR	
Hydraulic Oil Filter.....	H-5522
Hydraulic Oil Filter.....	HC-5801
325D (EXCAVATORS) S/N: C9M1-139-UP	
Hydraulic Oil Filter.....	HC-5801
Hydraulic Oil Filter.....	H-5522
Hydraulic Oil Filter.....	HC-55170
325D (EXCAVATORS) S/N: C9M140-UP	
Hydraulic Oil Filter.....	H-5522
Hydraulic Oil Filter.....	HC-5801
325D (EXCAVATORS) S/N: DBH1-UP	
Hydraulic Oil Filter.....	H-5522
Hydraulic Oil Filter.....	HC-55170
Hydraulic Oil Filter.....	HC-5801
325D (EXCAVATORS) S/N: GBR1-UP	
Hydraulic Oil Filter.....	H-5522
Hydraulic Oil Filter.....	HC-55170
Hydraulic Oil Filter.....	HC-5801
325D (EXCAVATORS) S/N: GPB1-UP	
Hydraulic Oil Filter.....	HC-5801
Hydraulic Oil Filter.....	HC-55170
Hydraulic Oil Filter.....	H-5522
325D (EXCAVATORS) S/N: JCL1-UP	
Hydraulic Oil Filter.....	H-5522
Hydraulic Oil Filter.....	HC-5801
Hydraulic Oil Filter.....	HC-55170
325D (EXCAVATORS) S/N: KBE1-UP	
Hydraulic Oil Filter.....	HC-55170
Hydraulic Oil Filter.....	HC-5801
Hydraulic Oil Filter.....	H-5522
325D (EXCAVATORS) S/N: KDG1-UP	
Hydraulic Oil Filter.....	HC-5801
Hydraulic Oil Filter.....	HC-55170
Hydraulic Oil Filter.....	H-5522
325D (EXCAVATORS) S/N: LWR1-UP	
Hydraulic Oil Filter.....	H-5522
Hydraulic Oil Filter.....	HC-55170
Hydraulic Oil Filter.....	HC-5801
325D (EXCAVATORS) S/N: MCL1-UP	
Hydraulic Oil Filter.....	HC-5801
Hydraulic Oil Filter.....	HC-55170
Hydraulic Oil Filter.....	H-5522
325D (EXCAVATORS) S/N: PAL1-UP	
Hydraulic Oil Filter.....	HC-5801

MODEL/APPLICATION	SAKURA NO
CATERPILLAR	
Hydraulic Oil Filter.....	HC-55170
Hydraulic Oil Filter.....	H-5522
325D (EXCAVATORS) S/N: PKE1-UP	
Hydraulic Oil Filter.....	HC-5801
Hydraulic Oil Filter.....	HC-55170
Hydraulic Oil Filter.....	H-5522
325D (EXCAVATORS) S/N: RJK1-134-UP	
Hydraulic Oil Filter.....	H-5522
Hydraulic Oil Filter.....	HC-55170
Hydraulic Oil Filter.....	HC-5801
325D (EXCAVATORS) S/N: RJK135-UP	
Hydraulic Oil Filter.....	HC-55170
Hydraulic Oil Filter.....	H-5522
Hydraulic Oil Filter.....	HC-5801
325D (EXCAVATORS) S/N: SCR1-UP	
Hydraulic Oil Filter.....	H-5522
Hydraulic Oil Filter.....	HC-5801
Hydraulic Oil Filter.....	HC-55170
325D (EXCAVATORS) S/N: T2S1-UP	
Hydraulic Oil Filter.....	H-5522
Hydraulic Oil Filter.....	HC-55170
Hydraulic Oil Filter.....	HC-5801
325 LN (EXCAVATORS) CAT 3116 (S/N: 2SK1-UP)	
Hydraulic Oil Filter.....	H-5505
Hydraulic Oil Filter.....	HC-5505
325 LN (EXCAVATORS) CAT 3116 (S/N: 2SL1-UP)	
Hydraulic Oil Filter.....	HC-5505
Hydraulic Oil Filter.....	H-5505
325 LN (EXCAVATORS) CAT 3116 (S/N: 3LL1-UP)	
Hydraulic Oil Filter.....	HC-5505
Hydraulic Oil Filter.....	H-5505
325 LN (EXCAVATORS) CAT 3116 (S/N: 7LJ1-UP)	
Hydraulic Oil Filter.....	H-5505
Hydraulic Oil Filter.....	HC-5505
325 LN (EXCAVATORS) CAT 3116 (S/N: 9SG1-UP)	
Hydraulic Oil Filter.....	HC-5505
Hydraulic Oil Filter.....	H-5505
325 LN (EXCAVATORS) CAT 3116 (S/N: 9ZK1-UP)	
Hydraulic Oil Filter.....	HC-5505
Hydraulic Oil Filter.....	H-5505
325B L JA (EXCAVATORS) CAT 3116 (S/N: 8PR1-UP)	



ENGINE APPLICATION

MODEL/APPLICATION	SAKURA NO	MODEL/APPLICATION	SAKURA NO	MODEL/APPLICATION	SAKURA NO
CATERPILLAR		CATERPILLAR		CATERPILLAR	
325B L JA (EXCAVATORS) CAT 3116 (S/N: 8PR1-UP)		325C MH (MATERIAL HANDLERS) CAT 3116 (S/N: DTF1-UP)		330 (EXCAVATORS) CAT 3306 (S/N: 6WJ1-UP)	
Hydraulic Oil Filter.....	HC-5801	Hydraulic Oil Filter.....	HC-5801	Hydraulic Oil Filter.....	HC-5505
Hydraulic Oil Filter.....	HC-5505	Hydraulic Oil Filter.....	H-5522	Hydraulic Oil Filter.....	H-5505
325B L JA (EXCAVATORS) CAT 3116 (S/N: 8RR1-UP)		325C MH (MATERIAL HANDLERS) CAT 3116 (S/N: S2C1-UP)		330 (EXCAVATORS) CAT 3306 (S/N: 8CK1-UP)	
Hydraulic Oil Filter.....	HC-5801	Hydraulic Oil Filter.....	H-7942	Hydraulic Oil Filter.....	HC-5505
Hydraulic Oil Filter.....	HC-5505	Hydraulic Oil Filter.....	HC-5801	Hydraulic Oil Filter.....	H-5505
325B L US (EXCAVATORS) CAT 3116 (S/N: 2JR1-UP)		328d (EXCAVATORS) CAT S/N: GTN1-UP		330 (EXCAVATORS) CAT 3306 (S/N: 8FK1-UP)	
Hydraulic Oil Filter.....	H-7942	Hydraulic Oil Filter.....	H-5522	Hydraulic Oil Filter.....	H-5505
Hydraulic Oil Filter.....	HC-5505	Hydraulic Oil Filter.....	HC-55170	Hydraulic Oil Filter.....	HC-5505
Hydraulic Oil Filter.....	HC-5801	Hydraulic Oil Filter.....	HC-5801	330 (EXCAVATORS) CAT 3306 (S/N: 8RL1-UP)	
325B LN (EXCAVATORS) CAT 3116 (S/N: 4DS1-UP)		328d (EXCAVATORS) CAT S/N: KHK1-UP		Hydraulic Oil Filter.....	H-5505
Hydraulic Oil Filter.....	HC-5505	Hydraulic Oil Filter.....	HC-55170	Hydraulic Oil Filter.....	HC-5505
Hydraulic Oil Filter.....	HC-5801	Hydraulic Oil Filter.....	H-5522	330 (EXCAVATORS) CAT 3306 (S/N: 9ML1-UP)	
Hydraulic Oil Filter.....	H-7942	Hydraulic Oil Filter.....	HC-5801	Hydraulic Oil Filter.....	HC-5505
325B LN (EXCAVATORS) CAT 3116 (S/N: 5BS1-UP)		328d (EXCAVATORS) CAT S/N: MKR1-UP		Hydraulic Oil Filter.....	H-5505
Hydraulic Oil Filter.....	HC-5505	Hydraulic Oil Filter.....	HC-5801	330 (EXCAVATORS) CAT 3306 (S/N: 9NG1-UP)	
Hydraulic Oil Filter.....	H-7942	Hydraulic Oil Filter.....	HC-55170	Hydraulic Oil Filter.....	H-5505
Hydraulic Oil Filter.....	HC-5801	Hydraulic Oil Filter.....	H-5522	Hydraulic Oil Filter.....	HC-5505
325B LN (EXCAVATORS) CAT 3116 (S/N: 6DN1-UP)		330 (EXCAVATORS) CAT 3116 (S/N: 6ZK1-UP)		330 (EXCAVATORS) CAT 3306 (S/N: 9PJ1-UP)	
Hydraulic Oil Filter.....	HC-5505	Hydraulic Oil Filter.....	HC-5505	Hydraulic Oil Filter.....	H-5505
Hydraulic Oil Filter.....	H-7942	Hydraulic Oil Filter.....	H-5505	Hydraulic Oil Filter.....	HC-5505
Hydraulic Oil Filter.....	HC-5801	330 (EXCAVATORS) CAT 3304B (S/N: 6WJ1-UP)		Hydraulic Oil Filter.....	H-5505
325B LN (EXCAVATORS) CAT 3116 (S/N: 8FN1-UP)		Hydraulic Oil Filter.....	HC-5505	330 (EXCAVATORS) S/N: 2EL00445-UP	
Hydraulic Oil Filter.....	HC-5801	Hydraulic Oil Filter.....	H-5505	Hydraulic Oil Filter.....	H-5505
Hydraulic Oil Filter.....	HC-5505	330 (EXCAVATORS) CAT 3304B (S/N: 9NG1-UP)		Hydraulic Oil Filter.....	HC-5505
Hydraulic Oil Filter.....	H-7942	Hydraulic Oil Filter.....	H-5505	330 (EXCAVATORS) S/N: 2EL00717-UP	
325C FP (FOREST EQUIPMENTS) CAT 3116 (S/N: G1L1-UP)		Hydraulic Oil Filter.....	HC-5505	Hydraulic Oil Filter.....	HC-5505
Hydraulic Oil Filter.....	H-7942	Hydraulic Oil Filter.....	H-5505	330 L (EXCAVATORS) CAT 3304B (S/N: 2EL1-UP)	
Hydraulic Oil Filter.....	HC-55170	330 (EXCAVATORS) CAT 3306 (S/N: 2EL1-UP)		Hydraulic Oil Filter.....	HC-5505
Hydraulic Oil Filter.....	HC-5801	Hydraulic Oil Filter.....	H-5505	Hydraulic Oil Filter.....	H-5505
325C FP (FOREST EQUIPMENTS) CAT 3116 (S/N: M2K1-UP)		330 (EXCAVATORS) CAT 3306 (S/N: 5YM1-UP)		330 L (EXCAVATORS) CAT 3304B (S/N: 2ZM1-UP)	
Hydraulic Oil Filter.....	HC-55170	Hydraulic Oil Filter.....	HC-5505	Hydraulic Oil Filter.....	HC-5505
Hydraulic Oil Filter.....	HC-5801	Hydraulic Oil Filter.....	H-5505	Hydraulic Oil Filter.....	H-5505
Hydraulic Oil Filter.....	H-7942	330 (EXCAVATORS) CAT 3306 (S/N: 5YM1-UP)		330 L (EXCAVATORS) CAT 3304B (S/N: 5YM1-UP)	
325C FP (FOREST EQUIPMENTS) CAT 3116 (S/N: S3M1-UP)		Hydraulic Oil Filter.....	H-5505	Hydraulic Oil Filter.....	HC-5505
Hydraulic Oil Filter.....	H-7942	Hydraulic Oil Filter.....	HC-5505	330 L (EXCAVATORS) CAT 3304B (S/N: 5YM1-UP)	
Hydraulic Oil Filter.....	HC-5801	330 (EXCAVATORS) CAT 3306 (S/N: 6SK1-UP)		Hydraulic Oil Filter.....	HC-5505
Hydraulic Oil Filter.....	HC-55170	Hydraulic Oil Filter.....	HC-5505	Hydraulic Oil Filter.....	H-5505
325C FP (FOREST EQUIPMENTS) CAT 3116 (S/N: Y4P1-UP)		Hydraulic Oil Filter.....	H-5505	330 L (EXCAVATORS) CAT 3304B (S/N: 5YM1-UP)	
Hydraulic Oil Filter.....	HC-55170	Hydraulic Oil Filter.....	HC-5505	Hydraulic Oil Filter.....	HC-5505
Hydraulic Oil Filter.....	HC-5801	330 (EXCAVATORS) CAT 3306 (S/N: 6SK1-UP)		Hydraulic Oil Filter.....	H-5505
Hydraulic Oil Filter.....	H-7942	Hydraulic Oil Filter.....	H-5505	Hydraulic Oil Filter.....	H-5505



ENGINE APPLICATION

MODEL/APPLICATION	SAKURA NO	MODEL/APPLICATION	SAKURA NO	MODEL/APPLICATION	SAKURA NO
CATERPILLAR		CATERPILLAR		CATERPILLAR	
330 L (EXCAVATORS) CAT 3304B (S/N: 6SK1-UP)		330 L (EXCAVATORS) CAT 3306 (S/N: 6WJ1-UP)		Hydraulic Oil Filter.....	H-7942
Hydraulic Oil Filter.....	H-5505	Hydraulic Oil Filter.....	H-5505	Hydraulic Oil Filter.....	HC-5801
Hydraulic Oil Filter.....	HC-5505	Hydraulic Oil Filter.....	HC-5505		
330 L (EXCAVATORS) CAT 3304B (S/N: 6WJ1-UP)		330 L (EXCAVATORS) CAT 3306 (S/N: 6ZK1-UP)		330B (EXCAVATORS) S/N: 4RS396-UP	
Hydraulic Oil Filter.....	H-5505	Hydraulic Oil Filter.....	H-5505	Hydraulic Oil Filter.....	HC-5801
Hydraulic Oil Filter.....	HC-5505	Hydraulic Oil Filter.....	HC-5505	Hydraulic Oil Filter.....	HC-5505
				Hydraulic Oil Filter.....	H-7942
330 L (EXCAVATORS) CAT 3304B (S/N: 6ZK1-UP)		330 L (EXCAVATORS) CAT 3306 (S/N: 8CK1-UP)		330C L (EXCAVATORS) CAT C9 (S/N: CAP1-903-UP)	
Hydraulic Oil Filter.....	H-5505	Hydraulic Oil Filter.....	H-5505	Hydraulic Oil Filter.....	H-5522
Hydraulic Oil Filter.....	HC-5505	Hydraulic Oil Filter.....	HC-5505	Hydraulic Oil Filter.....	HC-5801
330 L (EXCAVATORS) CAT 3304B (S/N: 8CK1-UP)		330 L (EXCAVATORS) CAT 3306 (S/N: 8RL1-UP)		330C L (EXCAVATORS) CAT C9 (S/N: CAP1-UP)	
Hydraulic Oil Filter.....	H-5505	Hydraulic Oil Filter.....	H-5505	Hydraulic Oil Filter.....	H-5522
Hydraulic Oil Filter.....	HC-5505	Hydraulic Oil Filter.....	HC-5505	Hydraulic Oil Filter.....	HC-5801
330 L (EXCAVATORS) CAT 3304B (S/N: 8FK1-UP)		330 L (EXCAVATORS) CAT 3306 (S/N: 9ML1-UP)		330C L (EXCAVATORS) CAT C9 (S/N: CAP226-UP)	
Hydraulic Oil Filter.....	H-5505	Hydraulic Oil Filter.....	H-5505	Hydraulic Oil Filter.....	HC-5801
Hydraulic Oil Filter.....	HC-5505	Hydraulic Oil Filter.....	HC-5505	Hydraulic Oil Filter.....	H-5522
330 L (EXCAVATORS) CAT 3304B (S/N: 8RL1-UP)		330 L (EXCAVATORS) CAT 3306 (S/N: 9NG1-UP)		330C L (EXCAVATORS) CAT C9 (S/N: CAP904-UP)	
Hydraulic Oil Filter.....	HC-5505	Hydraulic Oil Filter.....	H-5505	Hydraulic Oil Filter.....	HC-5801
Hydraulic Oil Filter.....	H-5505	Hydraulic Oil Filter.....	HC-5505	Hydraulic Oil Filter.....	H-5522
330 L (EXCAVATORS) CAT 3304B (S/N: 9ML1-UP)		330 L (EXCAVATORS) CAT 3306 (S/N: 9PJ1-UP)		330C L (EXCAVATORS) CAT C9 (S/N: CGZ1-UP)	
Hydraulic Oil Filter.....	HC-5505	Hydraulic Oil Filter.....	HC-5505	Hydraulic Oil Filter.....	H-7942
Hydraulic Oil Filter.....	H-5505	Hydraulic Oil Filter.....	H-5505	Hydraulic Oil Filter.....	HC-5801
330 L (EXCAVATORS) CAT 3304B (S/N: 9NG1-UP)		330 L (EXCAVATORS) CAT 3306 (S/N: 9WJ1-UP)		330C L (EXCAVATORS) CAT C9 (S/N: CYA1-UP)	
Hydraulic Oil Filter.....	HC-5505	Hydraulic Oil Filter.....	HC-5505	Hydraulic Oil Filter.....	H-7942
Hydraulic Oil Filter.....	H-5505	Hydraulic Oil Filter.....	H-5505	Hydraulic Oil Filter.....	HC-5801
330 L (EXCAVATORS) CAT 3304B (S/N: 9PJ1-UP)		330 L (EXCAVATORS) S/N: 2EL1-UP		330C L (EXCAVATORS) CAT C9 (S/N: DKY1-1243-UP)	
Hydraulic Oil Filter.....	H-5505	Hydraulic Oil Filter.....	H-5505	Hydraulic Oil Filter.....	HC-5801
Hydraulic Oil Filter.....	HC-5505			Hydraulic Oil Filter.....	H-5522
330 L (EXCAVATORS) CAT 3304B (S/N: 9WJ1-UP)		330B (EXCAVATORS) CAT 3306 (S/N: 4RS1-UP)		330C L (EXCAVATORS) CAT C9 (S/N: DKY1243-UP)	
Hydraulic Oil Filter.....	H-5505	Hydraulic Oil Filter.....	HC-5801	Hydraulic Oil Filter.....	H-5522
Hydraulic Oil Filter.....	HC-5505	Hydraulic Oil Filter.....	HC-5505	Hydraulic Oil Filter.....	HC-5801
330 L (EXCAVATORS) CAT 3306 (S/N: 2ZM1-UP)		330B (EXCAVATORS) CAT 3306 (S/N: 5LS1-UP)		330C L (EXCAVATORS) CAT C9 (S/N: DKY1-UP)	
Hydraulic Oil Filter.....	H-5505	Hydraulic Oil Filter.....	HC-5801	Hydraulic Oil Filter.....	HC-5801
Hydraulic Oil Filter.....	HC-5505	Hydraulic Oil Filter.....	HC-5505	Hydraulic Oil Filter.....	H-7942
				Hydraulic Oil Filter.....	HC-55170
330 L (EXCAVATORS) CAT 3306 (S/N: 5YM1-UP)		330B (EXCAVATORS) CAT 3306 (S/N: 8SR1-UP)		330C L (EXCAVATORS) CAT C9 (S/N: GXX1-UP)	
Hydraulic Oil Filter.....	HC-5505	Hydraulic Oil Filter.....	HC-5801	Hydraulic Oil Filter.....	HC-5801
Hydraulic Oil Filter.....	H-5505	Hydraulic Oil Filter.....	H-7942	Hydraulic Oil Filter.....	H-7942
				Hydraulic Oil Filter.....	HC-55170
330 L (EXCAVATORS) CAT 3306 (S/N: 6SK1-UP)		330B (EXCAVATORS) CAT 3306 (S/N: 8TR1-UP)		330C L (EXCAVATORS) CAT C9 (S/N: JAB1-UP)	
Hydraulic Oil Filter.....	HC-5505	Hydraulic Oil Filter.....	HC-5505	Hydraulic Oil Filter.....	HC-5801
Hydraulic Oil Filter.....	H-5505	Hydraulic Oil Filter.....	HC-5505	Hydraulic Oil Filter.....	H-7942



ENGINE APPLICATION

MODEL/APPLICATION	SAKURA NO	MODEL/APPLICATION	SAKURA NO	MODEL/APPLICATION	SAKURA NO
CATERPILLAR		CATERPILLAR		CATERPILLAR	
330C L (EXCAVATORS) CAT C9 (S/N: KDD1-UP)		Hydraulic Oil Filter.....	HC-5801	Hydraulic Oil Filter.....	H-5522
Hydraulic Oil Filter.....	H-7942	Hydraulic Oil Filter.....	HC-55170	Hydraulic Oil Filter.....	HC-55170
Hydraulic Oil Filter.....	HC-5801	Hydraulic Oil Filter.....	H-7942		
330C LN (EXCAVATORS) CAT C9 (S/N: CGZ1-UP)		330C FP (FOREST EQUIPMENTS) CAT 3304B (S/N: B4N1-UP)		330D (EXCAVATORS) S/N: FFK1-UP	
Hydraulic Oil Filter.....	HC-5801	Hydraulic Oil Filter.....	HC-5801	Hydraulic Oil Filter.....	HC-5801
Hydraulic Oil Filter.....	H-7942	Hydraulic Oil Filter.....	H-7942	Hydraulic Oil Filter.....	HC-55170
		Hydraulic Oil Filter.....	HC-55170	Hydraulic Oil Filter.....	H-5522
330C (EXCAVATORS) CAT C9 (S/N: CYA1-UP) , 2002-UP		330C MH (MATERIAL HANDLERS) CAT 3304B (S/N: MKM1-UP)		330D (EXCAVATORS) S/N: GGE1-UP	
Hydraulic Oil Filter.....	H-7942	Hydraulic Oil Filter.....	HC-5801	Hydraulic Oil Filter.....	H-5522
Hydraulic Oil Filter.....	HC-5801	Hydraulic Oil Filter.....	H-5522	Hydraulic Oil Filter.....	HC-5801
				Hydraulic Oil Filter.....	HC-55170
330C (EXCAVATORS) CAT C9 (S/N: DKY1-UP)		330CLME (EXCAVATORS) 2004-UP		330D (EXCAVATORS) S/N: H3K1-UP	
Hydraulic Oil Filter.....	H-7942	Hydraulic Oil Filter.....	H-7942	Hydraulic Oil Filter.....	H-5522
Hydraulic Oil Filter.....	HC-5801	Hydraulic Oil Filter.....	HC-5801	Hydraulic Oil Filter.....	HC-5801
Hydraulic Oil Filter.....	HC-55170			Hydraulic Oil Filter.....	HC-55170
330C (EXCAVATORS) CAT C9 (S/N: GKX1-UP)		330D (EXCAVATORS) S/N: B6H1-UP		330D (EXCAVATORS) S/N: HAS1-UP	
Hydraulic Oil Filter.....	HC-5801	Hydraulic Oil Filter.....	H-5522	Hydraulic Oil Filter.....	HC-55170
Hydraulic Oil Filter.....	H-7942	Hydraulic Oil Filter.....	HC-55170	Hydraulic Oil Filter.....	HC-5801
Hydraulic Oil Filter.....	HC-55170	Hydraulic Oil Filter.....	HC-5801	Hydraulic Oil Filter.....	H-5522
330C (EXCAVATORS) CAT C9 (S/N: JCD1-UP)		330D (EXCAVATORS) S/N: C5K1-222-UP		330D (EXCAVATORS) S/N: JLP1-UP	
Hydraulic Oil Filter.....	HC-5801	Hydraulic Oil Filter.....	H-5522	Hydraulic Oil Filter.....	H-5522
Hydraulic Oil Filter.....	H-7942	Hydraulic Oil Filter.....	HC-55170	Hydraulic Oil Filter.....	HC-5801
Hydraulic Oil Filter.....	H-5522	Hydraulic Oil Filter.....	HC-5801	Hydraulic Oil Filter.....	HC-55170
330C (EXCAVATORS) CAT C9 (S/N: JNK1-UP)		330D (EXCAVATORS) S/N: C5K223-UP		330D (EXCAVATORS) S/N: L2K1-UP	
Hydraulic Oil Filter.....	H-7942	Hydraulic Oil Filter.....	H-5522	Hydraulic Oil Filter.....	HC-5801
Hydraulic Oil Filter.....	HC-5801	Hydraulic Oil Filter.....	HC-55170	Hydraulic Oil Filter.....	HC-55170
Hydraulic Oil Filter.....	H-5522	Hydraulic Oil Filter.....	HC-5801	Hydraulic Oil Filter.....	H-5522
330C (EXCAVATORS) CAT C9 (S/N: MCA1-UP)		330D (EXCAVATORS) S/N: E4K1-349-UP		330D (EXCAVATORS) S/N: LEM1-190-UP	
Hydraulic Oil Filter.....	HC-5801	Hydraulic Oil Filter.....	HC-5801	Hydraulic Oil Filter.....	H-5522
Hydraulic Oil Filter.....	H-7942	Hydraulic Oil Filter.....	H-5522	Hydraulic Oil Filter.....	HC-55170
Hydraulic Oil Filter.....	HC-55170	Hydraulic Oil Filter.....	HC-55170	Hydraulic Oil Filter.....	HC-5801
330C (EXCAVATORS) CAT C9 (S/N: MKM1-UP)		330D (EXCAVATORS) S/N: EAH1-UP		330D (EXCAVATORS) S/N: LEM191-UP	
Hydraulic Oil Filter.....	HC-5801	Hydraulic Oil Filter.....	HC-55170	Hydraulic Oil Filter.....	HC-55170
Hydraulic Oil Filter.....	H-5522	Hydraulic Oil Filter.....	H-5522	Hydraulic Oil Filter.....	HC-5801
Hydraulic Oil Filter.....	H-5522	Hydraulic Oil Filter.....	HC-5801	Hydraulic Oil Filter.....	H-5522
330C FP (FOREST EQUIPMENTS) CAT 3304B (S/N: B1K1-UP)		330D (EXCAVATORS) S/N: EAK350-UP		330D (EXCAVATORS) S/N: MAG1-UP	
Hydraulic Oil Filter.....	HC-55170	Hydraulic Oil Filter.....	H-5522	Hydraulic Oil Filter.....	H-5522
Hydraulic Oil Filter.....	H-7942	Hydraulic Oil Filter.....	HC-55170	Hydraulic Oil Filter.....	HC-55170
Hydraulic Oil Filter.....	HC-5801	Hydraulic Oil Filter.....	HC-5801	Hydraulic Oil Filter.....	HC-5801
330C FP (FOREST EQUIPMENTS) CAT 3304B (S/N: B2L1-UP)		330D (EXCAVATORS) S/N: EDX1-UP		330D (EXCAVATORS) S/N: MEY1-UP	
Hydraulic Oil Filter.....	HC-55170	Hydraulic Oil Filter.....	H-5522	Hydraulic Oil Filter.....	HC-5801
Hydraulic Oil Filter.....	HC-5801	Hydraulic Oil Filter.....	HC-55170	Hydraulic Oil Filter.....	HC-55170
Hydraulic Oil Filter.....	H-7942	Hydraulic Oil Filter.....	HC-5801	Hydraulic Oil Filter.....	H-5522
330C FP (FOREST EQUIPMENTS) CAT 3304B (S/N: B3M1-UP)		330D (EXCAVATORS) S/N: ERN1-UP			
Hydraulic Oil Filter.....	HC-5801	Hydraulic Oil Filter.....	HC-5801		



ENGINE APPLICATION

MODEL/APPLICATION	SAKURA NO	MODEL/APPLICATION	SAKURA NO	MODEL/APPLICATION	SAKURA NO
CATERPILLAR		CATERPILLAR		CATERPILLAR	
330D (EXCAVATORS) S/N: MWP1-UP		Hydraulic Oil Filter.....	H-7942	345B (EXCAVATORS) CAT 3176 (S/N: 3MW1-UP)	
Hydraulic Oil Filter.....	H-5522	330B L (EXCAVATORS) CAT 3306 (S/N: 6DR1-UP)		Hydraulic Oil Filter.....	HC-5505
Hydraulic Oil Filter.....	HC-55170	Hydraulic Oil Filter.....	HC-5801	Hydraulic Oil Filter.....	HC-5801
Hydraulic Oil Filter.....	HC-5801	Hydraulic Oil Filter.....	H-7942	Hydraulic Oil Filter.....	H-7942
330D (EXCAVATORS) S/N: NBD1-UP		Hydraulic Oil Filter.....	HC-5505	345B (EXCAVATORS) CAT 3176 (S/N: 4SS1-UP)	
Hydraulic Oil Filter.....	HC-5801	330B L (EXCAVATORS) CAT 3306 (S/N: 8SR1-UP)		Hydraulic Oil Filter.....	HC-5505
Hydraulic Oil Filter.....	H-5522	Hydraulic Oil Filter.....	H-7942	Hydraulic Oil Filter.....	H-7942
Hydraulic Oil Filter.....	HC-55170	Hydraulic Oil Filter.....	HC-5801	Hydraulic Oil Filter.....	HC-5801
330D (EXCAVATORS) S/N: RAS1-UP		Hydraulic Oil Filter.....	HC-5505	345B (EXCAVATORS) CAT 3176 (S/N: 7KS1-UP)	
Hydraulic Oil Filter.....	HC-5801	330B L (EXCAVATORS) CAT 3306 (S/N: 8TR1-UP)		Hydraulic Oil Filter.....	HC-5505
Hydraulic Oil Filter.....	HC-55170	Hydraulic Oil Filter.....	HC-5505	Hydraulic Oil Filter.....	H-7942
Hydraulic Oil Filter.....	H-5522	Hydraulic Oil Filter.....	HC-5801	Hydraulic Oil Filter.....	HC-5801
330D (EXCAVATORS) S/N: T2Y1-UP		Hydraulic Oil Filter.....	H-7942	345B (EXCAVATORS) CAT 3176 (S/N: 9GS1-UP)	
Hydraulic Oil Filter.....	H-5522	330B L (EXCAVATORS) S/N: 3YR1-UP		Hydraulic Oil Filter.....	HC-5505
Hydraulic Oil Filter.....	HC-5801	Hydraulic Oil Filter.....	HC-55170	Hydraulic Oil Filter.....	H-7942
Hydraulic Oil Filter.....	HC-55170	Hydraulic Oil Filter.....	H-7942	Hydraulic Oil Filter.....	HC-5801
330D (EXCAVATORS) S/N: THJ1-UP		Hydraulic Oil Filter.....	HC-5801	345B (EXCAVATORS) CAT 3176 (S/N: AGS1-UP)	
Hydraulic Oil Filter.....	HC-55170	330B L US (EXCAVATORS) CAT 3304B (S/N: 6DR1-UP)		Hydraulic Oil Filter.....	HC-5505
Hydraulic Oil Filter.....	HC-5801	Hydraulic Oil Filter.....	HC-5505	Hydraulic Oil Filter.....	H-7942
Hydraulic Oil Filter.....	H-5522	Hydraulic Oil Filter.....	H-7942	Hydraulic Oil Filter.....	HC-5801
330 LME (EXCAVATORS)		Hydraulic Oil Filter.....	HC-5801	345B (EXCAVATORS) CAT 3176 (S/N: AKJ1-UP)	
Hydraulic Oil Filter.....	HC-5505	330B LN (EXCAVATORS) CAT 3306 (S/N: 3YR1-UP)		Hydraulic Oil Filter.....	HC-5505
Hydraulic Oil Filter.....	H-5505	Hydraulic Oil Filter.....	HC-5505	Hydraulic Oil Filter.....	H-5522
330B L (EXCAVATORS) CAT 3306 (S/N: 1JS1-UP)		Hydraulic Oil Filter.....	H-7942	Hydraulic Oil Filter.....	HC-5801
Hydraulic Oil Filter.....	HC-5505	330B LN (EXCAVATORS) CAT 3306 (S/N: 5LR1-UP)		Hydraulic Oil Filter.....	H-7942
Hydraulic Oil Filter.....	HC-5801	Hydraulic Oil Filter.....	H-7942	Hydraulic Oil Filter.....	HC-5801
Hydraulic Oil Filter.....	H-7942	Hydraulic Oil Filter.....	HC-5801	Hydraulic Oil Filter.....	HC-5505
330B L (EXCAVATORS) CAT 3306 (S/N: 3YR1-UP)		Hydraulic Oil Filter.....	HC-5505	345B (EXCAVATORS) CAT 3176 (S/N: AKX1-UP)	
Hydraulic Oil Filter.....	H-7942	345B (EXCAVATORS) CAT 3176 (S/N: 2NW1-UP)		Hydraulic Oil Filter.....	H-5522
Hydraulic Oil Filter.....	HC-5505	Hydraulic Oil Filter.....	HC-5801	Hydraulic Oil Filter.....	H-7942
Hydraulic Oil Filter.....	HC-5801	Hydraulic Oil Filter.....	H-7942	Hydraulic Oil Filter.....	HC-5801
330B L (EXCAVATORS) CAT 3306 (S/N: 4RS1-UP)		Hydraulic Oil Filter.....	HC-5505	Hydraulic Oil Filter.....	HC-5505
Hydraulic Oil Filter.....	H-7942	345B (EXCAVATORS) CAT 3176 (S/N: 2SW1-UP)		Hydraulic Oil Filter.....	HC-5801
Hydraulic Oil Filter.....	HC-5801	Hydraulic Oil Filter.....	HC-5801	Hydraulic Oil Filter.....	H-7942
Hydraulic Oil Filter.....	HC-5505	Hydraulic Oil Filter.....	H-7942	Hydraulic Oil Filter.....	HC-5801
330B L (EXCAVATORS) CAT 3306 (S/N: 5LR1-UP)		Hydraulic Oil Filter.....	HC-5505	345B (EXCAVATORS) CAT 3176 (S/N: ALB1-UP)	
Hydraulic Oil Filter.....	HC-5801	345B (EXCAVATORS) CAT 3176 (S/N: 2ZW1-UP)		Hydraulic Oil Filter.....	H-7942
Hydraulic Oil Filter.....	HC-5505	Hydraulic Oil Filter.....	HC-5801	Hydraulic Oil Filter.....	HC-5801
Hydraulic Oil Filter.....	H-7942	Hydraulic Oil Filter.....	H-7942	Hydraulic Oil Filter.....	HC-5505
330B L (EXCAVATORS) CAT 3306 (S/N: 5LS1-UP)		Hydraulic Oil Filter.....	HC-5801	345B (EXCAVATORS) CAT 3176 (S/N: ALD1-UP)	
Hydraulic Oil Filter.....	HC-5505	345B (EXCAVATORS) CAT 3176 (S/N: 2ZW1-UP)		Hydraulic Oil Filter.....	HC-5505
Hydraulic Oil Filter.....	H-7942	Hydraulic Oil Filter.....	HC-5505	Hydraulic Oil Filter.....	H-5522
330B L (EXCAVATORS) CAT 3306 (S/N: 5LS1-UP)		Hydraulic Oil Filter.....	H-7942	Hydraulic Oil Filter.....	HC-5801
Hydraulic Oil Filter.....	HC-5505	Hydraulic Oil Filter.....	HC-5801	Hydraulic Oil Filter.....	H-7942
Hydraulic Oil Filter.....	HC-5801				



ENGINE APPLICATION

MODEL/APPLICATION	SAKURA NO	MODEL/APPLICATION	SAKURA NO	MODEL/APPLICATION	SAKURA NO
CATERPILLAR		CATERPILLAR		CATERPILLAR	
345B (EXCAVATORS) CAT 3176 (S/N: BFG1-UP)		Hydraulic Oil Filter.....	H-7942	Hydraulic Oil Filter.....	H-7942
Hydraulic Oil Filter.....	HC-5801	345B L (EXCAVATORS) CAT 3176C (S/N: 7KS1-UP)		Hydraulic Oil Filter.....	HC-5801
Hydraulic Oil Filter.....	H-7942	Hydraulic Oil Filter.....	HC-5505	345B L II (EXCAVATORS) CAT 3176C (S/N: AKX1-UP)	
Hydraulic Oil Filter.....	HC-5505	Hydraulic Oil Filter.....	H-7942	Hydraulic Oil Filter.....	H-7942
345B (EXCAVATORS) CAT 3176 (S/N: CCC1-UP)		Hydraulic Oil Filter.....	HC-5801	Hydraulic Oil Filter.....	HC-5505
Hydraulic Oil Filter.....	H-7942	345B L (EXCAVATORS) CAT 3176C (S/N: 9GS1-UP)		Hydraulic Oil Filter.....	HC-5801
Hydraulic Oil Filter.....	HC-5505	Hydraulic Oil Filter.....	HC-5505	Hydraulic Oil Filter.....	HC-5801
Hydraulic Oil Filter.....	HC-5801	Hydraulic Oil Filter.....	H-7942	Hydraulic Oil Filter.....	H-5522
345B (EXCAVATORS) CAT 3176 (S/N: DCW1-UP)		345B L (EXCAVATORS) CAT 3176C (S/N: BFG1-UP)		345B L II (EXCAVATORS) CAT 3176C (S/N: ALB1-UP)	
Hydraulic Oil Filter.....	HC-5505	Hydraulic Oil Filter.....	HC-5505	Hydraulic Oil Filter.....	HC-5505
Hydraulic Oil Filter.....	H-7942	Hydraulic Oil Filter.....	HC-5801	Hydraulic Oil Filter.....	HC-5801
Hydraulic Oil Filter.....	HC-5801	Hydraulic Oil Filter.....	H-7942	Hydraulic Oil Filter.....	H-7942
345B (EXCAVATORS) S/N: 7KS00365-UP		345 (EXCAVATORS) S/N: 7SK00365-UP		345B L II (EXCAVATORS) CAT 3176C (S/N: ALD1-UP)	
Hydraulic Oil Filter.....	H-7942	Hydraulic Oil Filter.....	H-7942	Hydraulic Oil Filter.....	HC-5505
Hydraulic Oil Filter.....	HC-5505	Hydraulic Oil Filter.....	HC-5505	Hydraulic Oil Filter.....	HC-5801
345B L (EXCAVATORS) CAT 3176C (S/N: 2SW1-UP)		345 BLME (EXCAVATORS)		Hydraulic Oil Filter.....	H-5522
Hydraulic Oil Filter.....	HC-5801	Hydraulic Oil Filter.....	H-7942	Hydraulic Oil Filter.....	H-7942
Hydraulic Oil Filter.....	H-7942	Hydraulic Oil Filter.....	HC-5505	345B L US (EXCAVATORS) CAT 3176C (S/N: 4SS1-UP)	
Hydraulic Oil Filter.....	HC-5505	345B II (EXCAVATORS) CAT 3176C (S/N: AGS1-UP)		Hydraulic Oil Filter.....	HC-5505
345B L (EXCAVATORS) S/N: 7KS00365-UP		Hydraulic Oil Filter.....	H-7942	Hydraulic Oil Filter.....	HC-5801
Hydraulic Oil Filter.....	H-7942	Hydraulic Oil Filter.....	HC-5801	Hydraulic Oil Filter.....	HC-5505
Hydraulic Oil Filter.....	HC-5505	Hydraulic Oil Filter.....	HC-5505	345B LC (EXCAVATORS) CAT 3176C (S/N: 2SW1-UP)	
345B L (EXCAVATORS) CAT 3176C (S/N: 2WS1-UP)		345B II (EXCAVATORS) CAT 3176C (S/N: AKJ1-UP)		Hydraulic Oil Filter.....	HC-5801
Hydraulic Oil Filter.....	HC-5801	Hydraulic Oil Filter.....	HC-5801	Hydraulic Oil Filter.....	H-7942
Hydraulic Oil Filter.....	HC-5505	Hydraulic Oil Filter.....	H-7942	Hydraulic Oil Filter.....	HC-5801
Hydraulic Oil Filter.....	H-7942	Hydraulic Oil Filter.....	HC-5505	Hydraulic Oil Filter.....	HC-5505
345B L (EXCAVATORS) CAT 3176C (S/N: 3MW1-UP)		345B II (EXCAVATORS) CAT 3176C (S/N: AKX1-UP)		345B LC (EXCAVATORS) CAT 3176C (S/N: BFG1-UP)	
Hydraulic Oil Filter.....	HC-5801	Hydraulic Oil Filter.....	HC-5801	Hydraulic Oil Filter.....	HC-5505
Hydraulic Oil Filter.....	H-7942	Hydraulic Oil Filter.....	H-7942	Hydraulic Oil Filter.....	HC-5801
Hydraulic Oil Filter.....	HC-5505	Hydraulic Oil Filter.....	HC-5505	Hydraulic Oil Filter.....	H-7942
345B L (EXCAVATORS) CAT 3176C (S/N: 4SS1-UP)		345B II (EXCAVATORS) CAT 3176C (S/N: ALB1-UP)		345C (EXCAVATORS) S/N: DHP1-382-UP	
Hydraulic Oil Filter.....	HC-5801	Hydraulic Oil Filter.....	HC-5801	Hydraulic Oil Filter.....	H-7942
Hydraulic Oil Filter.....	HC-5505	Hydraulic Oil Filter.....	H-7942	Hydraulic Oil Filter.....	HC-5801
Hydraulic Oil Filter.....	H-7942	Hydraulic Oil Filter.....	HC-5801	Hydraulic Oil Filter.....	HC-55170
345B L (EXCAVATORS) CAT 3176C (S/N: 5WS1-UP)		345B II (EXCAVATORS) CAT 3176C (S/N: ALD1-UP)		Hydraulic Oil Filter.....	H-5522
Hydraulic Oil Filter.....	HC-5801	Hydraulic Oil Filter.....	HC-5801	345C (EXCAVATORS) S/N: DHP383-UP	
Hydraulic Oil Filter.....	H-7942	Hydraulic Oil Filter.....	H-7942	Hydraulic Oil Filter.....	HC-5801
Hydraulic Oil Filter.....	HC-5505	Hydraulic Oil Filter.....	HC-5505	Hydraulic Oil Filter.....	HC-55170
345B L (EXCAVATORS) CAT 3176C (S/N: 6XS1-UP)		345B L II (EXCAVATORS) CAT 3176C (S/N: AGS1-UP)		Hydraulic Oil Filter.....	H-5522
Hydraulic Oil Filter.....	HC-5801	Hydraulic Oil Filter.....	HC-5505	345C (EXCAVATORS) S/N: ELS1-UP	
Hydraulic Oil Filter.....	H-7942	Hydraulic Oil Filter.....	HC-5801	Hydraulic Oil Filter.....	HC-5801
Hydraulic Oil Filter.....	HC-5505	Hydraulic Oil Filter.....	H-7942	345C (EXCAVATORS) S/N: ELS1-UP	
345B L (EXCAVATORS) CAT 3176C (S/N: 6XS1-UP)		345B L II (EXCAVATORS) CAT 3176C (S/N: AKJ1-UP)		Hydraulic Oil Filter.....	HC-5801
Hydraulic Oil Filter.....	HC-5801	Hydraulic Oil Filter.....	HC-5505	345C (EXCAVATORS) S/N: ELS1-UP	
Hydraulic Oil Filter.....	H-7942	Hydraulic Oil Filter.....	HC-5801	Hydraulic Oil Filter.....	HC-5801
Hydraulic Oil Filter.....	HC-5505	Hydraulic Oil Filter.....	H-5522		



ENGINE APPLICATION

MODEL/APPLICATION	SAKURA NO	MODEL/APPLICATION	SAKURA NO	MODEL/APPLICATION	SAKURA NO
CATERPILLAR		CATERPILLAR		CATERPILLAR	
345C (EXCAVATORS) S/N: GCL1-UP		350 (EXCAVATORS) CAT 3306 (S/N: 3ML1-UP)		365B (EXCAVATORS) CAT 3196 (S/N: CFJ1-UP)	
Hydraulic Oil Filter.....	HC-5801	Hydraulic Oil Filter.....	HC-5511	Hydraulic Oil Filter.....	HC-5516
345C (EXCAVATORS) S/N: GJR1-UP		Hydraulic Oil Filter.....	HC-5516	Hydraulic Oil Filter.....	HC-5511
Hydraulic Oil Filter.....	H-7942	Hydraulic Oil Filter.....	H-5505	Hydraulic Oil Filter.....	H-7942
Hydraulic Oil Filter.....	H-5522	350 (EXCAVATORS) CAT 3306 (S/N: 7RK1-UP)		365B (EXCAVATORS) CAT 3196 (S/N: CTY1-UP)	
Hydraulic Oil Filter.....	HC-55170	Hydraulic Oil Filter.....	HC-5516	Hydraulic Oil Filter.....	H-7942
Hydraulic Oil Filter.....	HC-5801	Hydraulic Oil Filter.....	H-5505	Hydraulic Oil Filter.....	HC-5511
345C (EXCAVATORS) S/N: GPH1-UP		Hydraulic Oil Filter.....	HC-5511	365B (EXCAVATORS) CAT 3196 (S/N: DER1-UP)	
Hydraulic Oil Filter.....	HC-5801	350 (EXCAVATORS) CAT 3306 (S/N: 8HK1-UP)		Hydraulic Oil Filter.....	H-7942
345C (EXCAVATORS) S/N: LYS1-YP-UP		Hydraulic Oil Filter.....	HC-5511	Hydraulic Oil Filter.....	HC-5511
Hydraulic Oil Filter.....	HC-5801	Hydraulic Oil Filter.....	H-5505	Hydraulic Oil Filter.....	HC-5516
345C (EXCAVATORS) S/N: SPC1-UP		350 (EXCAVATORS) CAT 3306 (S/N: 9DK1-UP)		365B (EXCAVATORS) CAT 3196 (S/N: JMB1-UP)	
Hydraulic Oil Filter.....	HC-5801	Hydraulic Oil Filter.....	HC-5511	Hydraulic Oil Filter.....	H-5522
345C (EXCAVATORS) S/N: TBA1-UP		Hydraulic Oil Filter.....	H-5505	Hydraulic Oil Filter.....	HC-5516
Hydraulic Oil Filter.....	HC-5801	Hydraulic Oil Filter.....	HC-5516	Hydraulic Oil Filter.....	HC-5511
345C (EXCAVATORS) S/N: WDE1-UP		350 (EXCAVATORS) CAT 3306 (S/N: 9FL1-UP)		365B (EXCAVATORS) CAT 3196 (S/N: PEG1-UP)	
Hydraulic Oil Filter.....	HC-5801	Hydraulic Oil Filter.....	H-5505	Hydraulic Oil Filter.....	HC-5511
350 (EXCAVATORS) CAT 3116 (S/N: 2ZL1-UP)		Hydraulic Oil Filter.....	HC-5516	Hydraulic Oil Filter.....	H-5522
Hydraulic Oil Filter.....	H-5505	Hydraulic Oil Filter.....	HC-5511	Hydraulic Oil Filter.....	HC-5516
350 (EXCAVATORS) CAT 3116 (S/N: 3ML1-UP)		35 (TRACTORS) S/N: 1TJ1-UP		365B (EXCAVATORS) CAT 3196 (S/N: SDL1-UP)	
Hydraulic Oil Filter.....	H-5505	Hydraulic Oil Filter.....	HC-5504	Hydraulic Oil Filter.....	H-5522
Hydraulic Oil Filter.....	HC-5511	35 (TRACTORS) S/N: 3HS1-UP		Hydraulic Oil Filter.....	HC-5511
Hydraulic Oil Filter.....	HC-5516	Hydraulic Oil Filter.....	HC-5504	Hydraulic Oil Filter.....	HC-5516
350 (EXCAVATORS) CAT 3116 (S/N: 7RK1-UP)		35 (TRACTORS) S/N: 8RD1-UP		365B II (EXCAVATORS) CAT S/N: 6AR1-UP , 2004-UP	
Hydraulic Oil Filter.....	H-5505	Hydraulic Oil Filter.....	HC-5504	Hydraulic Oil Filter.....	H-5522
Hydraulic Oil Filter.....	HC-5511	35 (TRACTORS) S/N: ADK1-UP		Hydraulic Oil Filter.....	HC-55300
Hydraulic Oil Filter.....	HC-5516	Hydraulic Oil Filter.....	HC-5504	Hydraulic Oil Filter.....	HC-5511
350 (EXCAVATORS) CAT 3116 (S/N: 8HK1-UP)		350BL (EXCAVATORS)		Hydraulic Oil Filter.....	HC-55290
Hydraulic Oil Filter.....	HC-5516	Hydraulic Oil Filter.....	H-7942	Hydraulic Oil Filter.....	HC-5516
Hydraulic Oil Filter.....	HC-5511	365B (EXCAVATORS) CAT 3196 (S/N: 9PZ1-UP) , 2007-UP		Hydraulic Oil Filter.....	HC-5511
Hydraulic Oil Filter.....	H-5505	Hydraulic Oil Filter.....	HC-5511	Hydraulic Oil Filter.....	HC-55300
350 (EXCAVATORS) CAT 3116 (S/N: 9DK1-UP)		Hydraulic Oil Filter.....	H-5522	Hydraulic Oil Filter.....	HC-55290
Hydraulic Oil Filter.....	HC-5511	Hydraulic Oil Filter.....	HC-5516	365B II (EXCAVATORS) CAT S/N: GAR1-UP , 2004-UP	
Hydraulic Oil Filter.....	HC-5516	Hydraulic Oil Filter.....	H-7942	Hydraulic Oil Filter.....	HC-5516
Hydraulic Oil Filter.....	H-5505	365B (EXCAVATORS) CAT 3196 (S/N: 9TZ1-UP)		Hydraulic Oil Filter.....	H-7942
350 (EXCAVATORS) CAT 3116 (S/N: 9FL1-UP)		Hydraulic Oil Filter.....	H-7942	Hydraulic Oil Filter.....	HC-5511
Hydraulic Oil Filter.....	HC-5511	Hydraulic Oil Filter.....	HC-5516	Hydraulic Oil Filter.....	HC-55290
Hydraulic Oil Filter.....	HC-5516	Hydraulic Oil Filter.....	HC-5511	Hydraulic Oil Filter.....	HC-55300
Hydraulic Oil Filter.....	H-5505			Hydraulic Oil Filter.....	H-5522



ENGINE APPLICATION

MODEL/APPLICATION	SAKURA NO	MODEL/APPLICATION	SAKURA NO	MODEL/APPLICATION	SAKURA NO
CATERPILLAR		CATERPILLAR		CATERPILLAR	
365B II (EXCAVATORS) CAT S/N: JMB1-UP , 2004-UP		365C (LOADERS) CAT C15 (S/N: FEN1-UP)		Hydraulic Oil Filter.....	HC-5516
Hydraulic Oil Filter.....	H-7942	Hydraulic Oil Filter.....	HC-55300	Hydraulic Oil Filter.....	H-5505
Hydraulic Oil Filter.....	HC-5516	Hydraulic Oil Filter.....	H-5522	Hydraulic Oil Filter.....	HC-5511
Hydraulic Oil Filter.....	HC-5511	Hydraulic Oil Filter.....	HC-5516		
Hydraulic Oil Filter.....	HC-55290	Hydraulic Oil Filter.....	HC-55290	375 (EXCAVATORS) CAT 3406 (S/N: 8WJ1-UP)	
Hydraulic Oil Filter.....	H-5522	Hydraulic Oil Filter.....	HC-5511	Hydraulic Oil Filter.....	HC-5516
Hydraulic Oil Filter.....	HC-55300			Hydraulic Oil Filter.....	H-5505
		365C (LOADERS) CAT C15 (S/N: GWC11-UP)		Hydraulic Oil Filter.....	HC-5511
365B II (EXCAVATORS) CAT S/N: PEG1-UP , 2004-UP		Hydraulic Oil Filter.....	HC-55290	375 (EXCAVATORS) CAT 3406 (S/N: 8XG1-313-UP)	
Hydraulic Oil Filter.....	H-7942	Hydraulic Oil Filter.....	HC-5516	Hydraulic Oil Filter.....	H-5505
Hydraulic Oil Filter.....	HC-55290	Hydraulic Oil Filter.....	H-5522	Hydraulic Oil Filter.....	HC-5516
Hydraulic Oil Filter.....	HC-55300	Hydraulic Oil Filter.....	HC-55300	Hydraulic Oil Filter.....	HC-5511
Hydraulic Oil Filter.....	HC-5516	Hydraulic Oil Filter.....	HC-5511		
Hydraulic Oil Filter.....	HC-5511	365C (LOADERS) CAT C15 (S/N: MCS1-UP)		375 (EXCAVATORS) CAT 3406 (S/N: 8XG313-UP)	
Hydraulic Oil Filter.....	H-5522	Hydraulic Oil Filter.....	HC-55300	Hydraulic Oil Filter.....	HC-5516
		Hydraulic Oil Filter.....	HC-5516	Hydraulic Oil Filter.....	HC-5511
365B II (EXCAVATORS) CAT S/N: SDL1-UP , 2004-UP		Hydraulic Oil Filter.....	HC-5511	Hydraulic Oil Filter.....	H-5505
Hydraulic Oil Filter.....	HC-55290	Hydraulic Oil Filter.....	HC-55290		
Hydraulic Oil Filter.....	H-5522	Hydraulic Oil Filter.....	H-5522	375 (EXCAVATORS) CAT 3406 (S/N: 9WL1-UP)	
Hydraulic Oil Filter.....	HC-55300	Hydraulic Oil Filter.....	HC-5511	Hydraulic Oil Filter.....	H-5505
Hydraulic Oil Filter.....	HC-5516	Hydraulic Oil Filter.....	HC-55290	Hydraulic Oil Filter.....	HC-5516
Hydraulic Oil Filter.....	HC-5511	Hydraulic Oil Filter.....	H-5522	Hydraulic Oil Filter.....	HC-5511
		365C (LOADERS) CAT C15 (S/N: MCY1-UP)		375 (EXCAVATORS) S/N: 8XG313-UP	
365BL (EXCAVATORS) CAT 3196 (S/N: 9PZ1-UP)		Hydraulic Oil Filter.....	HC-5516	Hydraulic Oil Filter.....	H-5505
Hydraulic Oil Filter.....	H-7942	Hydraulic Oil Filter.....	H-5522	Hydraulic Oil Filter.....	HC-5516
Hydraulic Oil Filter.....	HC-5511	Hydraulic Oil Filter.....	HC-55290	Hydraulic Oil Filter.....	HC-55300
Hydraulic Oil Filter.....	HC-5516	Hydraulic Oil Filter.....	HC-5511	Hydraulic Oil Filter.....	HC-5511
		365C (LOADERS) CAT C15 (S/N: MEM1-UP)		375L (EXCAVATORS) CAT 3406 (S/N: 11N01-UP)	
365BL (EXCAVATORS) CAT 3196 (S/N: AGD1-UP)		Hydraulic Oil Filter.....	HC-55290	Hydraulic Oil Filter.....	H-5505
Hydraulic Oil Filter.....	HC-5516	Hydraulic Oil Filter.....	H-5522		
Hydraulic Oil Filter.....	H-7942	Hydraulic Oil Filter.....	HC-55300	375L (EXCAVATORS) CAT 3406 (S/N: 1JM1-UP)	
Hydraulic Oil Filter.....	HC-5511	Hydraulic Oil Filter.....	HC-5511	Hydraulic Oil Filter.....	H-5505
		Hydraulic Oil Filter.....	HC-5516		
365C (EXCAVATORS) S/N: GWC1-10-UP		Hydraulic Oil Filter.....	HC-5516	375L (EXCAVATORS) CAT 3406 (S/N: 8WJ1-UP)	
Hydraulic Oil Filter.....	HC-55290	365C (LOADERS) CAT C15 (S/N: PAR2-UP)		Hydraulic Oil Filter.....	HC-5516
Hydraulic Oil Filter.....	H-5522	Hydraulic Oil Filter.....	HC-55300	Hydraulic Oil Filter.....	H-5505
Hydraulic Oil Filter.....	HC-5516	Hydraulic Oil Filter.....	HC-55290	Hydraulic Oil Filter.....	HC-5511
Hydraulic Oil Filter.....	HC-5511	Hydraulic Oil Filter.....	H-5522		
Hydraulic Oil Filter.....	HC-55300	Hydraulic Oil Filter.....	HC-5511	375L (EXCAVATORS) S/N: 8BHK1-UP	
		Hydraulic Oil Filter.....	HC-5516	Hydraulic Oil Filter.....	H-5505
365C (EXCAVATORS) S/N: PAR1-1-UP		Hydraulic Oil Filter.....	HC-5516	375L (EXCAVATORS) CAT 3406 (S/N: 8WJ771-UP)	
Hydraulic Oil Filter.....	HC-55290	375 (EXCAVATORS) CAT 3406 (S/N: 1JM1-UP)		Hydraulic Oil Filter.....	H-5505
Hydraulic Oil Filter.....	H-5522	Hydraulic Oil Filter.....	HC-5516		
Hydraulic Oil Filter.....	HC-55300	Hydraulic Oil Filter.....	H-5505	375L (EXCAVATORS) S/N: 8BHK1-UP	
Hydraulic Oil Filter.....	HC-5516	Hydraulic Oil Filter.....	HC-5511	Hydraulic Oil Filter.....	H-5505
Hydraulic Oil Filter.....	HC-5511				
		375 (EXCAVATORS) CAT 3406 (S/N: 6NK1-UP)		375L (EXCAVATORS) S/N: 9FL1-UP	
365C (LOADERS) CAT C15 (S/N: ELC1-UP)		Hydraulic Oil Filter.....	HC-5511		
Hydraulic Oil Filter.....	HC-5516	Hydraulic Oil Filter.....	HC-5516		
Hydraulic Oil Filter.....	HC-55290	Hydraulic Oil Filter.....	HC-5516		
Hydraulic Oil Filter.....	HC-55300	Hydraulic Oil Filter.....	H-5505		
Hydraulic Oil Filter.....	H-5522				
Hydraulic Oil Filter.....	HC-5511				



ENGINE APPLICATION

MODEL/APPLICATION	SAKURA NO	MODEL/APPLICATION	SAKURA NO	MODEL/APPLICATION	SAKURA NO
CATERPILLAR		CATERPILLAR		CATERPILLAR	
375L (EXCAVATORS) S/N: 9FL1-UP Hydraulic Oil Filter.....	H-5505	385B (EXCAVATORS) CAT 3456 (S/N: RCD1-UP) Hydraulic Oil Filter.....	HC-5516	416D (BACKHOE LOADERS) CAT 3054B (S/N: BFP1-UP) Hydraulic Oil Filter.....	HC-5512
385B (EXCAVATORS) CAT 3456 (S/N: ANS1-UP) Hydraulic Oil Filter.....	HC-5516	Hydraulic Oil Filter.....	H-5522	416D (BACKHOE LOADERS) CAT 3054B (S/N: BGJ1-UP) Hydraulic Oil Filter.....	HC-5512
Hydraulic Oil Filter.....	H-7942	Hydraulic Oil Filter.....	H-7942	Hydraulic Oil Filter.....	HC-5512
Hydraulic Oil Filter.....	HC-5511	385BL (EXCAVATORS) CAT 3456 (S/N: ANS1-UP) Hydraulic Oil Filter.....	H-7942	416D (BACKHOE LOADERS) CAT 3054B (S/N: BKG1-UP) Hydraulic Oil Filter.....	HC-5512
385B (EXCAVATORS) CAT 3456 (S/N: BFK1-UP) Hydraulic Oil Filter.....	HC-5511	Hydraulic Oil Filter.....	HC-5511	416D (BACKHOE LOADERS) CAT 3054C DIT Hydraulic Oil Filter.....	HC-5501
Hydraulic Oil Filter.....	H-7942	385BL (EXCAVATORS) CAT 3456 (S/N: CKB1-UP) Hydraulic Oil Filter.....	HC-5511	416E (BACKHOE LOADERS) S/N: SHA1-UP , 2011 Hydraulic Oil Filter.....	HC-5512
Hydraulic Oil Filter.....	H-5522	Hydraulic Oil Filter.....	H-7942	416E (CONSTRUCTION & MINING) S/N: BWC1-UP , 2011 Hydraulic Oil Filter.....	HC-5512
Hydraulic Oil Filter.....	HC-5516	385BL (EXCAVATORS) CAT 3456 (S/N: CLS1-UP) Hydraulic Oil Filter.....	HC-5511	416E (CONSTRUCTION & MINING) S/N: CBD1-5744 , 2011 Hydraulic Oil Filter.....	HC-5512
385B (EXCAVATORS) CAT 3456 (S/N: BLY1-UP) Hydraulic Oil Filter.....	H-7942	Hydraulic Oil Filter.....	HC-5516	416E (CONSTRUCTION & MINING) S/N: LMS1-UP , 2011 Hydraulic Oil Filter.....	HC-5512
Hydraulic Oil Filter.....	HC-5511	Hydraulic Oil Filter.....	HC-5516	416E (CONSTRUCTION & MINING) S/N: CBD1-UP Hydraulic Oil Filter.....	HC-5512
Hydraulic Oil Filter.....	H-5522	385BL (EXCAVATORS) CAT 3456 (S/N: FDL1-UP) Hydraulic Oil Filter.....	HC-5511	416E (CONSTRUCTION & MINING) S/N: 5PC1-10761 Hydraulic Oil Filter.....	H-5506
Hydraulic Oil Filter.....	HC-5516	385C (LOADERS) 2007-UP Hydraulic Oil Filter.....	HC-5503	Hydraulic Oil Filter.....	H-5510
Hydraulic Oil Filter.....	HC-5516	Hydraulic Oil Filter.....	HC-55290	416E (BACKHOE LOADERS) S/N: ELB1-UP Hydraulic Oil Filter.....	HC-5512
385B (EXCAVATORS) CAT 3456 (S/N: CKB1-UP) Hydraulic Oil Filter.....	H-7942	414E (BACKHOE LOADERS) S/N: ELB1-UP Hydraulic Oil Filter.....	HC-5512	416E (CONSTRUCTION & MINING) S/N: 8SG1-11999 Hydraulic Oil Filter.....	HC-5512
Hydraulic Oil Filter.....	HC-5511	416 (BACKHOE LOADERS) S/N: 8SG1-11999 Hydraulic Oil Filter.....	HC-5503	Hydraulic Oil Filter.....	HC-5503
Hydraulic Oil Filter.....	H-5522	416B (BACKHOE LOADERS) S/N: 8SG12000-UP Hydraulic Oil Filter.....	HC-5503	416E (CONSTRUCTION & MINING) C4.4 Hydraulic Oil Filter.....	HC-5512
Hydraulic Oil Filter.....	HC-5511	Hydraulic Oil Filter.....	HC-5506	416B TURBO (LOADERS) S/N: 8SG1-UP Hydraulic Oil Filter.....	HC-5503
385B (EXCAVATORS) CAT 3456 (S/N: CLS1-UP) Hydraulic Oil Filter.....	H-7942	416B (BACKHOE LOADERS) S/N: 8SG12000-UP Hydraulic Oil Filter.....	HC-5503	Hydraulic Oil Filter.....	HC-5503
Hydraulic Oil Filter.....	HC-5511	Hydraulic Oil Filter.....	HC-5506	416C (BACKHOE LOADERS) CAT 3054T (S/N: 1WR8116-UP) Hydraulic Oil Filter.....	HC-5512
Hydraulic Oil Filter.....	H-5522	416B (BACKHOE LOADERS) S/N: 8ZK1-5999 Hydraulic Oil Filter.....	HC-5512	Hydraulic Oil Filter.....	HC-5501
Hydraulic Oil Filter.....	H-7942	Hydraulic Oil Filter.....	HC-5506	416C (BACKHOE LOADERS) CAT 3054T (S/N: 4ZN16004-UP) Hydraulic Oil Filter.....	HC-5512
Hydraulic Oil Filter.....	HC-5511	416B (BACKHOE LOADERS) S/N: 8ZK6000-UP Hydraulic Oil Filter.....	HC-5506	Hydraulic Oil Filter.....	HC-5501
385B (EXCAVATORS) CAT 3456 (S/N: FDL1-UP) Hydraulic Oil Filter.....	H-7942	Hydraulic Oil Filter.....	HC-5512	416C (BACKHOE LOADERS) CAT 3054T (S/N: 1XR2184-2249) Hydraulic Oil Filter.....	HC-5501
Hydraulic Oil Filter.....	H-5522	416B (BACKHOE LOADERS) S/N: 8SG6000-UP Hydraulic Oil Filter.....	HC-5512	Hydraulic Oil Filter.....	HC-5512
Hydraulic Oil Filter.....	HC-5516	Hydraulic Oil Filter.....	HC-5512	416C (BACKHOE LOADERS) CAT 3054T (S/N: 4ZN16004-UP) Hydraulic Oil Filter.....	HC-5501
Hydraulic Oil Filter.....	H-5522	416B (BACKHOE LOADERS) S/N: 8ZK1-5999 Hydraulic Oil Filter.....	HC-5512	Hydraulic Oil Filter.....	HC-5512
Hydraulic Oil Filter.....	HC-5511	416B (BACKHOE LOADERS) S/N: 8ZK6000-UP Hydraulic Oil Filter.....	HC-5506	416C (BACKHOE LOADERS) CAT 3054T (S/N: 1XR2184-2249) Hydraulic Oil Filter.....	HC-5501
385B (EXCAVATORS) CAT 3456 (S/N: MYA1-UP) Hydraulic Oil Filter.....	HC-5516	Hydraulic Oil Filter.....	HC-5512	Hydraulic Oil Filter.....	HC-5512
Hydraulic Oil Filter.....	H-7942	416B (LOADERS) S/N: 8SG-UP Hydraulic Oil Filter.....	HC-5503	416C (BACKHOE LOADERS) CAT 3054T (S/N: 5YN15148-UP) Hydraulic Oil Filter.....	HC-5501
Hydraulic Oil Filter.....	HC-5511	Hydraulic Oil Filter.....	HC-5503	Hydraulic Oil Filter.....	HC-5501



ENGINE APPLICATION

MODEL/APPLICATION	SAKURA NO	MODEL/APPLICATION	SAKURA NO	MODEL/APPLICATION	SAKURA NO
CATERPILLAR		CATERPILLAR		CATERPILLAR	
416C (BACKHOE LOADERS) CAT 3054T (S/N: 5YN15148-UP) Hydraulic Oil Filter.....	HC-5512	416C (BACKHOE LOADERS) S/N: 1WR-UP Hydraulic Oil Filter.....	HC-5503	420E (CONSTRUCTION & MINING) S/N: GEK1-UP , 2011 Hydraulic Oil Filter.....	HC-5512
416C (BACKHOE LOADERS) CAT 3054T (S/N: BFP1-UP) Hydraulic Oil Filter.....	HC-5501	Hydraulic Oil Filter.....	HC-5512	420E (CONSTRUCTION & MINING) S/N: PRA1-UP , 2011 Hydraulic Oil Filter.....	HC-5512
Hydraulic Oil Filter.....	HC-5512	416C (BACKHOE LOADERS) S/N: 1XR1-2183 Hydraulic Oil Filter.....	HC-5506	420E (CONSTRUCTION & MINING) C4.4 Hydraulic Oil Filter.....	HC-5512
416C (BACKHOE LOADERS) CAT 3054T (S/N: BGJ1-UP) Hydraulic Oil Filter.....	HC-5501	Hydraulic Oil Filter.....	HC-5503	420E (CONSTRUCTION & MINING) S/N: PHC1-UP Hydraulic Oil Filter.....	HC-5512
Hydraulic Oil Filter.....	HC-5512	416C (BACKHOE LOADERS) S/N: 1XR2250-UP Hydraulic Oil Filter.....	HC-5506	422E (BACKHOE LOADERS) CAT S/N: CRS1-UP Hydraulic Oil Filter.....	HC-5512
416C (BACKHOE LOADERS) CAT 3054T (S/N: BKG1-UP) Hydraulic Oil Filter.....	HC-5512	Hydraulic Oil Filter.....	HC-5512	422E (BACKHOE LOADERS) CAT S/N: G4D1-UP Hydraulic Oil Filter.....	HC-5512
Hydraulic Oil Filter.....	HC-5501	416C (BACKHOE LOADERS) S/N: 1XR-UP Hydraulic Oil Filter.....	HC-5506	422E (BACKHOE LOADERS) CAT S/N: HBE1-UP Hydraulic Oil Filter.....	HC-5512
Hydraulic Oil Filter.....	HC-5512	Hydraulic Oil Filter.....	HC-5512	424D (BACKHOE LOADERS) CAT 3054C (S/N: BGP1-UP) Hydraulic Oil Filter.....	HC-5512
416C (BACKHOE LOADERS) S/N: 1AR-UP Hydraulic Oil Filter.....	HC-5506	416C (BACKHOE LOADERS) S/N: 4ZN-UP Hydraulic Oil Filter.....	HC-5512	Hydraulic Oil Filter.....	HC-5501
Hydraulic Oil Filter.....	HC-5503	Hydraulic Oil Filter.....	HC-5503	424D (BACKHOE LOADERS) CAT 3054C (S/N: BKR1-UP) Hydraulic Oil Filter.....	HC-5512
Hydraulic Oil Filter.....	HC-5506	416C (BACKHOE LOADERS) S/N: 4ZN-UP Hydraulic Oil Filter.....	HC-5506	Hydraulic Oil Filter.....	HC-5501
Hydraulic Oil Filter.....	HC-5512	416C (BACKHOE LOADERS) S/N: 5YN1-15147 Hydraulic Oil Filter.....	HC-5503	426 (BACKHOE LOADERS) S/N: 7BC1-3476 Hydraulic Oil Filter.....	H-5506
416C (BACKHOE LOADERS) S/N: 1BR-UP Hydraulic Oil Filter.....	HC-5512	Hydraulic Oil Filter.....	HC-5512	Hydraulic Oil Filter.....	H-5510
Hydraulic Oil Filter.....	HC-5506	416C (BACKHOE LOADERS) S/N: 5YN-UP Hydraulic Oil Filter.....	HC-5512	426B (BACKHOE LOADERS) S/N: 5YJ1-2299 Hydraulic Oil Filter.....	HC-5503
Hydraulic Oil Filter.....	HC-5503	Hydraulic Oil Filter.....	HC-5503	Hydraulic Oil Filter.....	HC-5512
Hydraulic Oil Filter.....	HC-5506	420E (BACKHOE LOADERS) S/N: HLS1-UP , 2011 Hydraulic Oil Filter.....	HC-5512	426B (BACKHOE LOADERS) S/N: 5YJ2300-UP Hydraulic Oil Filter.....	HC-5503
Hydraulic Oil Filter.....	HC-5512	420E (BACKHOE LOADERS) S/N: KPW1-UP , 2011 Hydraulic Oil Filter.....	HC-5512	Hydraulic Oil Filter.....	HC-5512
416C (BACKHOE LOADERS) S/N: 1CR-UP Hydraulic Oil Filter.....	HC-5503	420E (CONSTRUCTION & MINING) S/N: DAN1-UP , 2011 Hydraulic Oil Filter.....	HC-5512	426B (BACKHOE LOADERS) S/N: 6KL1-1199 Hydraulic Oil Filter.....	HC-5503
Hydraulic Oil Filter.....	HC-5506	420E (CONSTRUCTION & MINING) S/N: DJL1-UP , 2011 Hydraulic Oil Filter.....	HC-5512	Hydraulic Oil Filter.....	HC-5512
Hydraulic Oil Filter.....	HC-5512	420E (CONSTRUCTION & MINING) S/N: GAN1-UP , 2011 Hydraulic Oil Filter.....	HC-5512	426B (BACKHOE LOADERS) S/N: 6KL1200-UP Hydraulic Oil Filter.....	HC-5506
416C (BACKHOE LOADERS) S/N: 1KR1-UP Hydraulic Oil Filter.....	HC-5512	420E (CONSTRUCTION & MINING) S/N: GAN1-UP , 2011 Hydraulic Oil Filter.....	HC-5512	Hydraulic Oil Filter.....	HC-5506
Hydraulic Oil Filter.....	HC-5506				
416C (BACKHOE LOADERS) S/N: 1LR1-UP Hydraulic Oil Filter.....	HC-5503				
Hydraulic Oil Filter.....	HC-5506				
Hydraulic Oil Filter.....	HC-5512				
416C (BACKHOE LOADERS) S/N: 1WR1-8115 Hydraulic Oil Filter.....	HC-5512				
Hydraulic Oil Filter.....	HC-5506				



ENGINE APPLICATION

MODEL/APPLICATION	SAKURA NO	MODEL/APPLICATION	SAKURA NO	MODEL/APPLICATION	SAKURA NO
CATERPILLAR		CATERPILLAR		CATERPILLAR	
426B (BACKHOE LOADERS) S/N: 6KL1-UP		Hydraulic Oil Filter.....	HC-5512	428B (BACKHOE LOADERS) PERKINS (S/N: 7EJ1-5999)	
Hydraulic Oil Filter.....	HC-5503	Hydraulic Oil Filter.....	HC-5501	Hydraulic Oil Filter.....	HC-5512
426B (BACKHOE LOADERS) S/N: 7BC1-3476		426C (BACKHOE LOADERS) S/N: 1YR1-1516		Hydraulic Oil Filter.....	HC-5506
Hydraulic Oil Filter.....	H-5510	Hydraulic Oil Filter.....	HC-5512	Hydraulic Oil Filter.....	HC-5503
Hydraulic Oil Filter.....	H-5506	Hydraulic Oil Filter.....	HC-5506	428B (BACKHOE LOADERS) S/N: 7EJ6000-UP	
426C (BACKHOE LOADERS) S/N: 1CR1-863		Hydraulic Oil Filter.....	HC-5501	Hydraulic Oil Filter.....	HC-5512
Hydraulic Oil Filter.....	HC-5501	Hydraulic Oil Filter.....	HC-5506	Hydraulic Oil Filter.....	HC-5506
Hydraulic Oil Filter.....	HC-5506	426C (BACKHOE LOADERS) S/N: 1YR1517-UP		Hydraulic Oil Filter.....	HC-5503
Hydraulic Oil Filter.....	HC-5512	Hydraulic Oil Filter.....	HC-5512	428B (LOADERS) PERKINS (S/N: 3KK1-2999)	
426C (BACKHOE LOADERS) S/N: 1CR864-UP		Hydraulic Oil Filter.....	HC-5501	Hydraulic Oil Filter.....	HC-5503
Hydraulic Oil Filter.....	HC-5512	Hydraulic Oil Filter.....	HC-5512	Hydraulic Oil Filter.....	HC-5512
Hydraulic Oil Filter.....	HC-5501	Hydraulic Oil Filter.....	HC-5506	Hydraulic Oil Filter.....	HC-5506
Hydraulic Oil Filter.....	HC-5501	426C (BACKHOE LOADERS) S/N: 1ZR1000-UP		428C (BACKHOE LOADERS) S/N: 1SR1-UP	
426C (BACKHOE LOADERS) S/N: 1ER1-863		Hydraulic Oil Filter.....	HC-5506	Hydraulic Oil Filter.....	HC-5512
Hydraulic Oil Filter.....	HC-5503	Hydraulic Oil Filter.....	HC-5501	428C (BACKHOE LOADERS) S/N: 2CR1-UP	
Hydraulic Oil Filter.....	HC-5506	Hydraulic Oil Filter.....	HC-5512	Hydraulic Oil Filter.....	HC-5512
Hydraulic Oil Filter.....	HC-5501	Hydraulic Oil Filter.....	HC-5512	428C (LOADERS) PERKINS (S/N: 7EJ1-UP)	
Hydraulic Oil Filter.....	HC-5512	Hydraulic Oil Filter.....	HC-5501	Hydraulic Oil Filter.....	HC-5501
426C (BACKHOE LOADERS) S/N: 1ER864-899		Hydraulic Oil Filter.....	HC-5512	428C (LOADERS) PERKINS (S/N: 8RN1-UP)	
Hydraulic Oil Filter.....	HC-5512	Hydraulic Oil Filter.....	HC-5501	Hydraulic Oil Filter.....	HC-5506
Hydraulic Oil Filter.....	HC-5501	Hydraulic Oil Filter.....	HC-5512	Hydraulic Oil Filter.....	HC-5512
Hydraulic Oil Filter.....	HC-5501	Hydraulic Oil Filter.....	HC-5501	Hydraulic Oil Filter.....	HC-5501
426C (BACKHOE LOADERS) S/N: 1ER900-UP		426C (BACKHOE LOADERS) S/N: 1ZR926-999		428D (BACKHOE LOADERS) CAT 3054 (S/N: BLL1-UP)	
Hydraulic Oil Filter.....	HC-5512	Hydraulic Oil Filter.....	HC-5512	Hydraulic Oil Filter.....	HC-5512
Hydraulic Oil Filter.....	HC-5506	Hydraulic Oil Filter.....	HC-5501	428D (BACKHOE LOADERS) CAT 3054 (S/N: BNB1-UP)	
Hydraulic Oil Filter.....	HC-5501	Hydraulic Oil Filter.....	HC-5512	Hydraulic Oil Filter.....	HC-5512
426C (BACKHOE LOADERS) S/N: 1MR1-955		Hydraulic Oil Filter.....	HC-5501	428D (LOADERS) CAT 3054 (S/N: BMT1-UP)	
Hydraulic Oil Filter.....	HC-5512	Hydraulic Oil Filter.....	HC-5512	Hydraulic Oil Filter.....	HC-5512
Hydraulic Oil Filter.....	HC-5501	Hydraulic Oil Filter.....	HC-5501	428D (LOADERS) CAT 3054 (S/N: BNS1-UP)	
Hydraulic Oil Filter.....	HC-5506	Hydraulic Oil Filter.....	HC-5506	Hydraulic Oil Filter.....	HC-5512
426C (BACKHOE LOADERS) S/N: 1MR956-UP		426C (BACKHOE LOADERS) S/N: 7WN1100-UP		428D (LOADERS) CAT 3054 (S/N: BXC1-UP)	
Hydraulic Oil Filter.....	HC-5512	Hydraulic Oil Filter.....	HC-5512	Hydraulic Oil Filter.....	HC-5512
Hydraulic Oil Filter.....	HC-5501	Hydraulic Oil Filter.....	HC-5501	428D (LOADERS) CAT 3054 (S/N: DSX1-UP)	
Hydraulic Oil Filter.....	HC-5501	Hydraulic Oil Filter.....	HC-5506	Hydraulic Oil Filter.....	HC-5512
426C (BACKHOE LOADERS) S/N: 1NR1050-UP		Hydraulic Oil Filter.....	HC-5503	428D (LOADERS) CAT 3054 (S/N: MBM1-UP)	
Hydraulic Oil Filter.....	HC-5501	426C (BACKHOE LOADERS) S/N: 7WN939-1099		Hydraulic Oil Filter.....	HC-5512
Hydraulic Oil Filter.....	HC-5506	Hydraulic Oil Filter.....	HC-5501	428D (LOADERS) CAT 3054 (S/N: BXC1-UP)	
Hydraulic Oil Filter.....	HC-5512	Hydraulic Oil Filter.....	HC-5512	Hydraulic Oil Filter.....	HC-5512
426C (BACKHOE LOADERS) S/N: 1NR1-953		Hydraulic Oil Filter.....	HC-5501	428D (LOADERS) CAT 3054 (S/N: BXC1-UP)	
Hydraulic Oil Filter.....	HC-5501	Hydraulic Oil Filter.....	HC-5506	Hydraulic Oil Filter.....	HC-5512
Hydraulic Oil Filter.....	HC-5506	Hydraulic Oil Filter.....	HC-5503	428D (LOADERS) CAT 3054 (S/N: BXC1-UP)	
Hydraulic Oil Filter.....	HC-5512	426C (BACKHOE LOADERS) S/N: 7WN939-1099		Hydraulic Oil Filter.....	HC-5512
Hydraulic Oil Filter.....	HC-5501	Hydraulic Oil Filter.....	HC-5501	428D (LOADERS) CAT 3054 (S/N: BXC1-UP)	
Hydraulic Oil Filter.....	HC-5512	Hydraulic Oil Filter.....	HC-5512	Hydraulic Oil Filter.....	HC-5512
Hydraulic Oil Filter.....	HC-5503	428 (LOADERS) S/N: 6TC1-UP		428D (LOADERS) CAT 3054 (S/N: BXC1-UP)	
426C (BACKHOE LOADERS) S/N: 1NR954-1049		Hydraulic Oil Filter.....	HC-5501	Hydraulic Oil Filter.....	HC-5512
Hydraulic Oil Filter.....	HC-5501	Hydraulic Oil Filter.....	H-5506	428D (LOADERS) CAT 3054 (S/N: BXC1-UP)	
Hydraulic Oil Filter.....	HC-5506	Hydraulic Oil Filter.....	H-5510	Hydraulic Oil Filter.....	HC-5512
Hydraulic Oil Filter.....	HC-5512	Hydraulic Oil Filter.....	H-5510		



ENGINE APPLICATION

MODEL/APPLICATION	SAKURA NO	MODEL/APPLICATION	SAKURA NO	MODEL/APPLICATION	SAKURA NO
CATERPILLAR		CATERPILLAR		CATERPILLAR	
428E (BACKHOE LOADERS) CAT 3054DIT , 2006-UP Hydraulic Oil Filter.....	HC-5512	434E (BACKHOE LOADERS) CAT S/N: CRS1-UP Hydraulic Oil Filter.....	HC-5512	436C (LOADERS) CAT 3054 (S/N: 1PR1599-UP) Hydraulic Oil Filter.....	HC-5512
428 SERIES II (LOADERS) CAT 3054 (S/N: 6TC6564-6TC7999) Hydraulic Oil Filter..... Hydraulic Oil Filter.....	H-5506 H-5510	434E (BACKHOE LOADERS) CAT S/N: FSH1-UP Hydraulic Oil Filter.....	HC-5512	436C (LOADERS) CAT 3054 (S/N: 1RR1-997-UP) Hydraulic Oil Filter..... Hydraulic Oil Filter.....	HC-5506 HC-5503
428 SERIES II (LOADERS) CAT 3054 (S/N: 6TC8000-UP) Hydraulic Oil Filter..... Hydraulic Oil Filter.....	H-5510 H-5506	434E (BACKHOE LOADERS) CAT S/N: G4D1-UP Hydraulic Oil Filter.....	HC-5512	436C (LOADERS) CAT 3054 (S/N: 1RR998-UP) Hydraulic Oil Filter..... Hydraulic Oil Filter.....	HC-5506 HC-5503
430D (LOADERS) CAT 3054 (S/N: BML04800-UP) Hydraulic Oil Filter.....	HC-5512	436 (BACKHOE LOADERS) PERKINS 4.236 (S/N: 5KF1-UP) Hydraulic Oil Filter..... Hydraulic Oil Filter.....	H-5506 H-5510	436C (LOADERS) CAT 3054 (S/N: 2AR1-1603-UP) Hydraulic Oil Filter..... Hydraulic Oil Filter.....	HC-5506 HC-5503
430D (LOADERS) CAT 3054 (S/N: BML1-UP) Hydraulic Oil Filter.....	HC-5512	436B (BACKHOE LOADERS) CAT 3054 (S/N: 6MJ1-UP) Hydraulic Oil Filter..... Hydraulic Oil Filter.....	HC-5503 HC-5506	436C (LOADERS) CAT 3054 (S/N: 2AR1604-UP) Hydraulic Oil Filter.....	HC-5512
430D (LOADERS) CAT 3054 (S/N: BNK05900-UP) Hydraulic Oil Filter.....	HC-5512	436B (BACKHOE LOADERS) S/N: 7FL1-UP Hydraulic Oil Filter..... Hydraulic Oil Filter..... Hydraulic Oil Filter.....	HC-5512 HC-5503 HC-5506	436C (LOADERS) CAT 3054 (S/N: 2BR1-910-UP) Hydraulic Oil Filter..... Hydraulic Oil Filter.....	HC-5506 HC-5503
430D (LOADERS) CAT 3054 (S/N: BNK1-UP) Hydraulic Oil Filter.....	HC-5512	436B (LOADERS) CAT 3054 (S/N: 6MJ1-UP) Hydraulic Oil Filter..... Hydraulic Oil Filter.....	HC-5503 HC-5506	436C (LOADERS) CAT 3054 (S/N: 2BR911-UP) Hydraulic Oil Filter.....	HC-5503
430E (BACKHOE LOADERS) CAT S/N: DDT1-UP Hydraulic Oil Filter.....	HC-5512	436B (LOADERS) CAT 3054 (S/N: 7FL1-UP) Hydraulic Oil Filter..... Hydraulic Oil Filter.....	HC-5503 HC-5506	436C (LOADERS) CAT 3054 (S/N: 7WN1-UP) Hydraulic Oil Filter..... Hydraulic Oil Filter.....	HC-5506 HC-5503
430E (BACKHOE LOADERS) CAT S/N: EAT1-UP Hydraulic Oil Filter.....	HC-5512	436C (LOADERS) CAT 3054 (S/N: 1FR1-1415-UP) Hydraulic Oil Filter..... Hydraulic Oil Filter.....	HC-5506 HC-5503	436C (LOADERS) CAT 3054 (S/N: 8TN1-924-UP) Hydraulic Oil Filter..... Hydraulic Oil Filter.....	HC-5503 HC-5506
432D (BACKHOE LOADERS) CAT 3054 (S/N: BLD1-UP) Hydraulic Oil Filter.....	HC-5512	436C (LOADERS) CAT 3054 (S/N: 1FR1416-UP) Hydraulic Oil Filter.....	HC-5512	436C (LOADERS) CAT 3054 (S/N: 8TN925-UP) Hydraulic Oil Filter.....	HC-5512
432D (LOADERS) CAT 3054 (S/N: TDR1-UP) Hydraulic Oil Filter.....	HC-5512	436C (LOADERS) CAT 3054 (S/N: 1GR1-915-UP) Hydraulic Oil Filter..... Hydraulic Oil Filter.....	HC-5506 HC-5503	436C (LOADERS) CAT 3054 (S/N: 9JN1-883-UP) Hydraulic Oil Filter..... Hydraulic Oil Filter.....	HC-5506 HC-5503
432D (LOADERS) CAT 3054 (S/N: WEP1-UP) Hydraulic Oil Filter.....	HC-5512	436C (LOADERS) CAT 3054 (S/N: 1GR916-1GR949) Hydraulic Oil Filter.....	HC-5512	436C (LOADERS) CAT 3054 (S/N: 9JN884-UP) Hydraulic Oil Filter..... Hydraulic Oil Filter.....	HC-5506 HC-5503
432E (BACKHOE LOADERS) 2008-UP Hydraulic Oil Filter.....	HC-5512	436C (LOADERS) CAT 3054 (S/N: 1GR950-UP) Hydraulic Oil Filter..... Hydraulic Oil Filter.....	HC-5503 HC-5506	436C (LOADERS) CAT 3054 (S/N: 9JN884-UP) Hydraulic Oil Filter..... Hydraulic Oil Filter.....	HC-5506 HC-5503
433C (LOADERS) PERKINS (S/N: 2JM1-UP) Hydraulic Oil Filter.....	HC-5504	436C (LOADERS) CAT 3054 (S/N: 1PR1-1598-UP) Hydraulic Oil Filter..... Hydraulic Oil Filter.....	HC-5503 HC-5506	436 II (LOADERS) S/N: 5KF1-805-UP Hydraulic Oil Filter.....	HC-5501
433C (LOADERS) PERKINS (S/N: 3TM1-3TM1) Hydraulic Oil Filter.....	HC-5504			436 II (LOADERS) S/N: 5KF806-UP Hydraulic Oil Filter..... Hydraulic Oil Filter.....	H-5506 HC-5501



ENGINE APPLICATION

MODEL/APPLICATION	SAKURA NO	MODEL/APPLICATION	SAKURA NO	MODEL/APPLICATION	SAKURA NO
CATERPILLAR		CATERPILLAR		CATERPILLAR	
438 (LOADERS) PERKINS 4.236 (S/N: 3DJ1-827-UP)		Hydraulic Oil Filter.....	HC-5506	Hydraulic Oil Filter.....	HC-5504
Hydraulic Oil Filter.....	H-5506	438C (LOADERS) CAT 3054 (S/N: 9KN1400-UP)		Hydraulic Oil Filter.....	HC-5503
Hydraulic Oil Filter.....	H-5510	Hydraulic Oil Filter.....	HC-5512	Hydraulic Oil Filter.....	HC-5512
438 (LOADERS) PERKINS 4.236 (S/N: 3DJ828-UP)		438D (LOADERS) CAT 3054 (S/N: BPE1-UP)		45 (TRACTORS) S/N: 1DR1-1105-UP	
Hydraulic Oil Filter.....	H-5510	Hydraulic Oil Filter.....	HC-5512	Hydraulic Oil Filter.....	HC-5503
Hydraulic Oil Filter.....	H-5506	438D (LOADERS) CAT 3054 (S/N: BPN1-UP)		Hydraulic Oil Filter.....	HC-5504
438B (LOADERS) CAT 3054 (S/N: 3KK1-2999-UP)		Hydraulic Oil Filter.....	HC-5512	Hydraulic Oil Filter.....	HC-5512
Hydraulic Oil Filter.....	HC-5506	438 SERIES II (LOADERS) CAT 3054 (S/N: 3DJ828-UP)		Hydraulic Oil Filter.....	HC-5506
Hydraulic Oil Filter.....	HC-5503	Hydraulic Oil Filter.....	H-5510	45 (TRACTORS) S/N: 3BK1-UP	
438B (LOADERS) CAT 3054 (S/N: 3KK3000-UP)		Hydraulic Oil Filter.....	H-5506	Hydraulic Oil Filter.....	HC-5504
Hydraulic Oil Filter.....	HC-5506	442D (LOADERS) CAT 3054 (S/N: BRG1-UP)		Hydraulic Oil Filter.....	HC-5503
Hydraulic Oil Filter.....	HC-5503	Hydraulic Oil Filter.....	HC-5512	45 (TRACTORS) S/N: 4DZ1-2123-UP	
438C (LOADERS) CAT 3054 (S/N: 1JR1107-UP)		442D (LOADERS) CAT 3054 (S/N: BRY1-UP)		Hydraulic Oil Filter.....	HC-5512
Hydraulic Oil Filter.....	HC-5512	Hydraulic Oil Filter.....	HC-5512	Hydraulic Oil Filter.....	HC-5504
438C (LOADERS) CAT 3054 (S/N: 1JR1-1106-UP)		442D (LOADERS) CAT 3054 (S/N: SMJ1-UP)		Hydraulic Oil Filter.....	HC-5506
Hydraulic Oil Filter.....	HC-5506	Hydraulic Oil Filter.....	HC-5512	Hydraulic Oil Filter.....	HC-5504
Hydraulic Oil Filter.....	HC-5503	442D (LOADERS) CAT 3054 (S/N: TBD1-UP)		45 (TRACTORS) S/N: 4KW1-UP	
438C (LOADERS) CAT 3054 (S/N: 1TR1-1283-UP)		Hydraulic Oil Filter.....	HC-5512	Hydraulic Oil Filter.....	HC-5504
Hydraulic Oil Filter.....	HC-5506	442E (BACKHOE LOADERS) CAT S/N: CRS1-UP , 2006-UP		45 (TRACTORS) S/N: 4YL1-UP	
Hydraulic Oil Filter.....	HC-5503	Hydraulic Oil Filter.....	HC-5512	Hydraulic Oil Filter.....	HC-5504
438C (LOADERS) CAT 3054 (S/N: 1TR1284-1TR1549)		442E (BACKHOE LOADERS) CAT S/N: GKZ1-UP , 2006-UP		45 (TRACTORS) S/N: ABF1-UP	
Hydraulic Oil Filter.....	HC-5512	Hydraulic Oil Filter.....	HC-5512	Hydraulic Oil Filter.....	HC-5504
438C (LOADERS) CAT 3054 (S/N: 1TR1550-UP)		442E (BACKHOE LOADERS) CAT S/N: LBE1-UP , 2006-UP		50 (HYDRAULIC SYSTEMS) S/N: 14E1-14E1117	
Hydraulic Oil Filter.....	HC-5503	Hydraulic Oil Filter.....	HC-5512	Hydraulic Oil Filter.....	H-5503
Hydraulic Oil Filter.....	HC-5506	446 (LOADERS) CAT 3114 (S/N: 6XF1-UP)		50 (HYDRAULIC SYSTEMS) S/N: 61D1-61D95	
438C (LOADERS) CAT 3054 (S/N: 2DR1-2716-UP)		Hydraulic Oil Filter.....	HC-5504	Hydraulic Oil Filter.....	H-5503
Hydraulic Oil Filter.....	HC-5512	Hydraulic Oil Filter.....	H-5510	508 (FOREST EQUIPMENTS) S/N: 2HD1-UP	
Hydraulic Oil Filter.....	HC-5503	Hydraulic Oil Filter.....	H-5506	Hydraulic Oil Filter.....	H-5506
438C (LOADERS) CAT 3054 (S/N: 2DR2717-2DR3249)		446B (LOADERS) CAT 3114 (S/N: 5BL1-2499-UP)		508 (FOREST EQUIPMENTS) S/N: 9NC1-UP	
Hydraulic Oil Filter.....	HC-5512	Hydraulic Oil Filter.....	HC-5506	Hydraulic Oil Filter.....	H-5506
438C (LOADERS) CAT 3054 (S/N: 2DR3250-UP)		Hydraulic Oil Filter.....	HC-5504	5080 (EXCAVATORS) CAT 3406B (Excluding S/N: 11N6900)	
Hydraulic Oil Filter.....	HC-5506	Hydraulic Oil Filter.....	HC-5503	Hydraulic Oil Filter.....	H-5505
Hydraulic Oil Filter.....	HC-5503	Hydraulic Oil Filter.....	HC-5512	5080 (EXCAVATORS) CAT 3406B (S/N: 6XK1-UP)	
438C (LOADERS) CAT 3054 (S/N: 9KN1061-9KN1199)		446B (LOADERS) S/N: 5BL2500-UP		Hydraulic Oil Filter.....	HC-5512
Hydraulic Oil Filter.....	HC-5512	Hydraulic Oil Filter.....	HC-5512	5080 (EXCAVATORS) CAT 3406B (S/N: 8SL1-UP)	
438C (LOADERS) CAT 3054 (S/N: 9KN1-1060-UP)		45 (TRACTORS) S/N: 1DR1106-UP		Hydraulic Oil Filter.....	HC-5511
Hydraulic Oil Filter.....	HC-5503	Hydraulic Oil Filter.....	HC-5506	Hydraulic Oil Filter.....	H-5505
				Hydraulic Oil Filter.....	HC-5516



ENGINE APPLICATION

MODEL/APPLICATION	SAKURA NO	MODEL/APPLICATION	SAKURA NO	MODEL/APPLICATION	SAKURA NO
CATERPILLAR		CATERPILLAR		CATERPILLAR	
5080 (EXCAVATORS) CAT 3406B (S/N: 6XK1-UP)		5110B (EXCAVATORS) CAT 3412E (S/N: AAK1-UP)		Hydraulic Oil Filter.....	H-55270
Hydraulic Oil Filter.....	H-5505	Hydraulic Oil Filter.....	H-5506	518C (FOREST EQUIPMENTS) S/N: 81-UP	
5090B (EXCAVATORS) CAT 3456 (S/N: CLD1-UP)		Hydraulic Oil Filter.....	H-5001	Hydraulic Oil Filter.....	H-55270
Hydraulic Oil Filter.....	H-7942	5110B (EXCAVATORS) CAT 3412E (S/N: AAK227-UP)		518C (FOREST EQUIPMENTS) S/N: 9HJ1-UP	
Hydraulic Oil Filter.....	HC-5511	Hydraulic Oil Filter.....	H-5001	Hydraulic Oil Filter.....	H-5508
Hydraulic Oil Filter.....	HC-5516	Hydraulic Oil Filter.....	H-5506	518 (FOREST EQUIPMENTS) CAT 3304 (S/N: 50S1-UP) , 2005-UP	
5090B (EXCAVATORS) CAT 3456 (S/N: SJY1-UP)		5130 (EXCAVATORS) CAT 3508 (S/N: 5ZL1-UP)		Hydraulic Oil Filter.....	H-5504
Hydraulic Oil Filter.....	HC-5511	Hydraulic Oil Filter.....	HC-5516	Hydraulic Oil Filter.....	H-5508
Hydraulic Oil Filter.....	H-7942	Hydraulic Oil Filter.....	H-5506	518 (FOREST EQUIPMENTS) CAT 3304 (S/N: 55U1-UP) , 2005-UP	
Hydraulic Oil Filter.....	HC-5516	5130B (EXCAVATORS) CAT 3508B (S/N: 7TJ1-UP)		Hydraulic Oil Filter.....	H-5504
5090B FS (EXCAVATORS) CAT 3456 (S/N: CLD1-UP)		Hydraulic Oil Filter.....	HC-5516	Hydraulic Oil Filter.....	H-5508
Hydraulic Oil Filter.....	HC-5511	Hydraulic Oil Filter.....	H-5506	518 (FOREST EQUIPMENTS) CAT 3304 (S/N: 94U1-UP) , 2005-UP	
Hydraulic Oil Filter.....	HC-5516	5130 (EXCAVATORS) CAT 3508B (S/N: 4CS1-UP)		Hydraulic Oil Filter.....	H-5504
5110 (EXCAVATORS) CAT 3412E (S/N: 7GN1-UP) , 2007-UP		Hydraulic Oil Filter.....	H-5506	Hydraulic Oil Filter.....	H-5508
Hydraulic Oil Filter.....	HC-5516	Hydraulic Oil Filter.....	HC-5516	518 (FOREST EQUIPMENTS) S/N: 1HE1-UP	
5110 (EXCAVATORS) CAT 3412E (S/N: 8HN1-UP) , 2007-UP		515 (FOREST EQUIPMENTS) CAT 3304 (S/N: 4LR1-UP)		Hydraulic Oil Filter.....	H-5504
Hydraulic Oil Filter.....	HC-5516	Hydraulic Oil Filter.....	H-5506	Hydraulic Oil Filter.....	H-55270
511 (FOREST EQUIPMENTS) CAT S/N: 5111-UP		Hydraulic Oil Filter.....	H-5510	518 (FOREST EQUIPMENTS) S/N: 1ZC1-UP	
Hydraulic Oil Filter.....	HC-5801	Hydraulic Oil Filter.....	HC-5504	Hydraulic Oil Filter.....	H-55270
Hydraulic Oil Filter.....	HC-55170	515 (FOREST EQUIPMENTS) S/N: 4LR718-UP		Hydraulic Oil Filter.....	H-5504
Hydraulic Oil Filter.....	H-5509	Hydraulic Oil Filter.....	HC-5504	518 (FOREST EQUIPMENTS) S/N: 3GA1-UP	
511 (FOREST EQUIPMENTS) CAT S/N: 5211-UP		Hydraulic Oil Filter.....	H-5508	Hydraulic Oil Filter.....	H-55270
Hydraulic Oil Filter.....	H-5509	515 (HYDRAULIC SYSTEMS) S/N: 28H1-UP		Hydraulic Oil Filter.....	H-5504
Hydraulic Oil Filter.....	HC-5801	Hydraulic Oil Filter.....	H-5508	518 (FOREST EQUIPMENTS) S/N: 4SA1-UP	
Hydraulic Oil Filter.....	HC-55170	517 (FOREST EQUIPMENTS) CAT 3304 DIT		Hydraulic Oil Filter.....	H-55270
511 (FOREST EQUIPMENTS) CAT S/N: 5221-UP		Hydraulic Oil Filter.....	H-5504	518 (FOREST EQUIPMENTS) S/N: 50S1-205	
Hydraulic Oil Filter.....	H-5509	517 (FOREST EQUIPMENTS) CAT 3304 (S/N: 5MW1-UP)		Hydraulic Oil Filter.....	H-5504
Hydraulic Oil Filter.....	HC-5801	Hydraulic Oil Filter.....	H-5504	Hydraulic Oil Filter.....	H-5508
Hydraulic Oil Filter.....	HC-55170	517 (FOREST EQUIPMENTS) CAT 3304 (S/N: 6PW1-UP)		Hydraulic Oil Filter.....	H-5504
511 (FOREST EQUIPMENTS) CAT S/N: THX1-UP		Hydraulic Oil Filter.....	H-5504	518 (FOREST EQUIPMENTS) S/N: 50S206-UP	
Hydraulic Oil Filter.....	HC-55170	518C (FOREST EQUIPMENTS) CAT 3304		Hydraulic Oil Filter.....	H-5508
Hydraulic Oil Filter.....	HC-5801	Hydraulic Oil Filter.....	H-5504	Hydraulic Oil Filter.....	H-5504
Hydraulic Oil Filter.....	H-5509	518C (FOREST EQUIPMENTS) S/N: 1CL1-UP		Hydraulic Oil Filter.....	H-5508
5110B (EXCAVATORS) CAT 3412E (S/N: AAA1-UP)		Hydraulic Oil Filter.....	H-5508	518 (FOREST EQUIPMENTS) S/N: 94U1-UP	
Hydraulic Oil Filter.....	H-5001	518C (FOREST EQUIPMENTS) S/N: 2DX1-UP		Hydraulic Oil Filter.....	H-5508
Hydraulic Oil Filter.....	HC-5516	Hydraulic Oil Filter.....	H-55270	Hydraulic Oil Filter.....	H-5504
Hydraulic Oil Filter.....	H-5506	518C (FOREST EQUIPMENTS) S/N: 4MX1-UP		518 (FOREST EQUIPMENTS) S/N: 95U1-UP	
5110B (EXCAVATORS) CAT 3412E (S/N: AAK1-226-UP)		Hydraulic Oil Filter.....	H-5506		
Hydraulic Oil Filter.....	H-5001				
Hydraulic Oil Filter.....	H-5506				



ENGINE APPLICATION

MODEL/APPLICATION	SAKURA NO	MODEL/APPLICATION	SAKURA NO	MODEL/APPLICATION	SAKURA NO
CATERPILLAR		CATERPILLAR		CATERPILLAR	
518 (FOREST EQUIPMENTS) S/N: 95U1-UP		Hydraulic Oil Filter.....	HC-5504	528 (FOREST EQUIPMENTS) S/N: 51S129-UP	
Hydraulic Oil Filter.....	H-5504	Hydraulic Oil Filter.....	H-5510	Hydraulic Oil Filter.....	H-5504
Hydraulic Oil Filter.....	H-5508	525B (FOREST EQUIPMENTS) CAT 3126 (S/N: 3KZ1--00795)		528 (FOREST EQUIPMENTS) S/N: 96C1-UP	
518 II (SKIDDERS) S/N: 12C1-UP		Hydraulic Oil Filter.....	H-5510	Hydraulic Oil Filter.....	H-5504
Hydraulic Oil Filter.....	H-5504	Hydraulic Oil Filter.....	H-5506	528 (FOREST EQUIPMENTS) S/N: 97C1-UP	
Hydraulic Oil Filter.....	H-55270	Hydraulic Oil Filter.....	HC-5504	Hydraulic Oil Filter.....	H-5504
518 II (SKIDDERS) S/N: 7RE1-UP		525B (FOREST EQUIPMENTS) CAT 3126 (S/N: 3KZ1--00874)		528 (LOADERS) w/3306 Eng.	
Hydraulic Oil Filter.....	H-55270	Hydraulic Oil Filter.....	H-5510	Hydraulic Oil Filter.....	H-55320
Hydraulic Oil Filter.....	H-5504	Hydraulic Oil Filter.....	HC-5504	530B (FOREST EQUIPMENTS) S/N: 3PX1-UP	
518 II (SKIDDERS) S/N: 9NE1-UP		525C (SKIDDERS) CAT S/N: 5251-UP		Hydraulic Oil Filter.....	H-55270
Hydraulic Oil Filter.....	H-5504	Hydraulic Oil Filter.....	HC-5504	530B (FOREST EQUIPMENTS) S/N: 5BK1-UP	
Hydraulic Oil Filter.....	H-55270	525C (SKIDDERS) CAT S/N: KHX304-UP		Hydraulic Oil Filter.....	H-5504
522C (FOREST EQUIPMENTS) CAT S/N: 07Z28250-UP		Hydraulic Oil Filter.....	HC-5504	Hydraulic Oil Filter.....	H-55270
Hydraulic Oil Filter.....	HC-5504	527 (FOREST EQUIPMENTS) CAT 3304 TA		530B (FOREST EQUIPMENTS) S/N: 7HX1-UP	
522C (FOREST EQUIPMENTS) CAT S/N: 2WL1-UP		Hydraulic Oil Filter.....	H-5510	Hydraulic Oil Filter.....	H-5509
Hydraulic Oil Filter.....	HC-5504	Hydraulic Oil Filter.....	H-5504	532 (FOREST EQUIPMENTS) CAT S/N: 5321-UP	
5230 (EXCAVATORS) CAT 3516 (S/N: 2PK1-UP)		527 (FOREST EQUIPMENTS) CAT 3304 (S/N: 2RS1-UP)		Hydraulic Oil Filter.....	HC-5801
Hydraulic Oil Filter.....	H-5510	Hydraulic Oil Filter.....	H-5510	Hydraulic Oil Filter.....	HC-55170
Hydraulic Oil Filter.....	H-5506	Hydraulic Oil Filter.....	H-5510	Hydraulic Oil Filter.....	H-5509
5230 (EXCAVATORS) CAT 3516 (S/N: 7LL1-UP)		527 (FOREST EQUIPMENTS) CAT 3304 (S/N: 4NS1-UP)		532 (FOREST EQUIPMENTS) CAT S/N: THX1-UP	
Hydraulic Oil Filter.....	H-5510	Hydraulic Oil Filter.....	H-5510	Hydraulic Oil Filter.....	HC-55170
Hydraulic Oil Filter.....	HC-5516	528B (FOREST EQUIPMENTS) S/N: 1PX1-UP		Hydraulic Oil Filter.....	H-5509
Hydraulic Oil Filter.....	H-5506	Hydraulic Oil Filter.....	H-55270	Hydraulic Oil Filter.....	HC-5801
525 (FOREST EQUIPMENTS) S/N: 1DN1069-1968-UP		528B (FOREST EQUIPMENTS) S/N: 7GX1-UP		533 (FOREST EQUIPMENTS) CAT 3126 (S/N: CDR1-UP)	
Hydraulic Oil Filter.....	HC-5504	Hydraulic Oil Filter.....	H-55270	Hydraulic Oil Filter.....	HC-55300
Hydraulic Oil Filter.....	H-5506	528B (FOREST EQUIPMENTS) S/N: 8S31-UP		535B (DUMP TRUCKS) CAT 3126 DITA	
Hydraulic Oil Filter.....	H-5510	Hydraulic Oil Filter.....	H-5504	Hydraulic Oil Filter.....	HC-5504
525 (FOREST EQUIPMENTS) S/N: 1DN1-1068-UP		Hydraulic Oil Filter.....	H-55270	535B (FOREST EQUIPMENTS) CAT 3126 (S/N: AAE1-UP)	
Hydraulic Oil Filter.....	H-5506	528 (FOREST EQUIPMENTS) CAT 3306 (S/N: 51S1-UP) , 2005-UP		Hydraulic Oil Filter.....	HC-5504
Hydraulic Oil Filter.....	HC-5504	Hydraulic Oil Filter.....	H-5504	Hydraulic Oil Filter.....	H-5510
Hydraulic Oil Filter.....	H-5510	528 (FOREST EQUIPMENTS) CAT 3306 (S/N: 96C1-UP) , 2005-UP		535B (FOREST EQUIPMENTS) S/N: AAE1-557-UP	
525B (FOREST EQUIPMENTS) CAT 3126 (S/N: 2KZ00797--00874)		Hydraulic Oil Filter.....	H-5504	Hydraulic Oil Filter.....	H-5506
Hydraulic Oil Filter.....	H-5506	528 (FOREST EQUIPMENTS) CAT 3306 (S/N: 97C1-UP) , 2005-UP		Hydraulic Oil Filter.....	H-5510
Hydraulic Oil Filter.....	H-5510	Hydraulic Oil Filter.....	H-5504	Hydraulic Oil Filter.....	HC-5504
Hydraulic Oil Filter.....	HC-5504	528 (FOREST EQUIPMENTS) CAT 3306 (S/N: 97C1-UP) , 2005-UP		535B (FOREST EQUIPMENTS) S/N: AAE558-561-UP	
525B (FOREST EQUIPMENTS) CAT 3126 (S/N: 3KZ00875-UP)		Hydraulic Oil Filter.....	H-5504	Hydraulic Oil Filter.....	H-5510
Hydraulic Oil Filter.....	H-5506	528 (FOREST EQUIPMENTS) S/N: 51S1-128		Hydraulic Oil Filter.....	H-5506
Hydraulic Oil Filter.....	H-5510	Hydraulic Oil Filter.....	H-5504	Hydraulic Oil Filter.....	HC-5504
Hydraulic Oil Filter.....	HC-5504	528 (FOREST EQUIPMENTS) S/N: 51S1-128			
525B (FOREST EQUIPMENTS) CAT 3126 (S/N: 3KZ00875-UP)		Hydraulic Oil Filter.....	H-5504		
Hydraulic Oil Filter.....	H-5506				



ENGINE APPLICATION

MODEL/APPLICATION	SAKURA NO	MODEL/APPLICATION	SAKURA NO	MODEL/APPLICATION	SAKURA NO
CATERPILLAR		CATERPILLAR		CATERPILLAR	
535B (FOREST EQUIPMENTS) S/N: AAE562-562-UP		545 (FOREST EQUIPMENTS) S/N: 2FZ1-431-UP		Hydraulic Oil Filter.....	HC-5506
Hydraulic Oil Filter.....	HC-5504	Hydraulic Oil Filter.....	H-5510	Hydraulic Oil Filter.....	HC-5512
535B (FOREST EQUIPMENTS) S/N: AAE563-567-UP		Hydraulic Oil Filter.....	HC-5504	55 (TRACTORS) S/N: 7TZ1-UP	
Hydraulic Oil Filter.....	H-5510	Hydraulic Oil Filter.....	H-5506	Hydraulic Oil Filter.....	HC-5504
Hydraulic Oil Filter.....	H-5506	545 (FOREST EQUIPMENTS) S/N: 2FZ432-432-UP		55 (TRACTORS) S/N: AEN1-UP	
Hydraulic Oil Filter.....	HC-5504	Hydraulic Oil Filter.....	H-5510	Hydraulic Oil Filter.....	HC-5504
535B (FOREST EQUIPMENTS) S/N: AAE568-582-UP		Hydraulic Oil Filter.....	HC-5504	550B (FOREST EQUIPMENTS) CAT 3056E (S/N: SAW1-UP)	
Hydraulic Oil Filter.....	HC-5504	Hydraulic Oil Filter.....	H-5506	Hydraulic Oil Filter.....	HC-5801
Hydraulic Oil Filter.....	H-5506	545 (FOREST EQUIPMENTS) S/N: 2FZ433-433-UP		551 (FOREST EQUIPMENTS) CAT S/N: 5511-UP	
Hydraulic Oil Filter.....	H-5510	Hydraulic Oil Filter.....	H-5510	Hydraulic Oil Filter.....	H-5509
535B (FOREST EQUIPMENTS) S/N: AAE583-708-UP		Hydraulic Oil Filter.....	HC-5504	Hydraulic Oil Filter.....	HC-55170
Hydraulic Oil Filter.....	HC-5504	Hydraulic Oil Filter.....	H-5510	Hydraulic Oil Filter.....	HC-5801
535B (FOREST EQUIPMENTS) S/N: AAE709-746-UP		Hydraulic Oil Filter.....	H-5506	551 (FOREST EQUIPMENTS) CAT S/N: 5521-UP	
Hydraulic Oil Filter.....	HC-5504	545 (FOREST EQUIPMENTS) S/N: 2FZ438-UP		Hydraulic Oil Filter.....	HC-55170
535B (FOREST EQUIPMENTS) S/N: AAE747-778-UP		Hydraulic Oil Filter.....	HC-5504	Hydraulic Oil Filter.....	HC-5801
Hydraulic Oil Filter.....	HC-5504	545C (FOREST EQUIPMENTS) CAT S/N: 5451-UP		Hydraulic Oil Filter.....	H-5509
Hydraulic Oil Filter.....	HC-5504	Hydraulic Oil Filter.....	HC-5504	Hydraulic Oil Filter.....	HC-55170
535B (FOREST EQUIPMENTS) S/N: AAE779-UP		Hydraulic Oil Filter.....	H-5510	Hydraulic Oil Filter.....	HC-5801
Hydraulic Oil Filter.....	HC-5504	Hydraulic Oil Filter.....	H-5506	Hydraulic Oil Filter.....	H-5509
535C (FOREST EQUIPMENTS) CAT S/N: 5351-UP		545 (FOREST EQUIPMENTS) S/N: 2FZ438-UP		551 (FOREST EQUIPMENTS) CAT S/N: THX1-UP	
Hydraulic Oil Filter.....	HC-5504	Hydraulic Oil Filter.....	HC-5504	Hydraulic Oil Filter.....	HC-55170
535C (FOREST EQUIPMENTS) CAT S/N: KHX1-UP		545C (FOREST EQUIPMENTS) CAT S/N: KHX1-UP		Hydraulic Oil Filter.....	HC-5801
Hydraulic Oil Filter.....	HC-5504	Hydraulic Oil Filter.....	HC-5504	Hydraulic Oil Filter.....	H-5509
Hydraulic Oil Filter.....	HC-5504	550 (FOREST EQUIPMENTS) CAT 3126 (S/N: 7ZN1-UP)		554 (FOREST EQUIPMENTS) S/N: 1AM-UP	
539 (FOREST EQUIPMENTS) CAT 3126 DITA (S/N: 1PZ-UP)		Hydraulic Oil Filter.....	HC-5801	Hydraulic Oil Filter.....	HC-5504
Hydraulic Oil Filter.....	HC-5505	55 (TRACTORS) S/N: 2CC1-UP		560B (FOREST EQUIPMENTS) CAT 3056E (S/N: TRA1-UP)	
541 (FOREST EQUIPMENTS) CAT S/N: 5411-UP		Hydraulic Oil Filter.....	H-5501	Hydraulic Oil Filter.....	HC-5801
Hydraulic Oil Filter.....	HC-5801	55 (TRACTORS) S/N: 2EJ1-UP		561M (PIPE LAYERS) CAT 3116	
Hydraulic Oil Filter.....	H-5509	Hydraulic Oil Filter.....	H-5501	Hydraulic Oil Filter.....	H-5504
Hydraulic Oil Filter.....	HC-55170	55 (TRACTORS) S/N: 3SM1-UP		561N (PIPE LAYERS) w/3126B Eng.	
541 (FOREST EQUIPMENTS) CAT S/N: THX1-UP		Hydraulic Oil Filter.....	HC-5504	Hydraulic Oil Filter.....	HC-55280
Hydraulic Oil Filter.....	HC-5801	55 (TRACTORS) S/N: 5DK1-1849-UP		561B (PIPE LAYERS) S/N: 62A1-UP	
Hydraulic Oil Filter.....	H-5509	Hydraulic Oil Filter.....	HC-5504	Hydraulic Oil Filter.....	H-5504
Hydraulic Oil Filter.....	HC-55170	Hydraulic Oil Filter.....	HC-5506	561C (PIPE LAYERS) S/N: 54X1-UP	
543 (FOREST EQUIPMENTS) CAT 3126 (S/N: ASJ1-UP)		Hydraulic Oil Filter.....	HC-5503	Hydraulic Oil Filter.....	H-5508
Hydraulic Oil Filter.....	HC-55300	Hydraulic Oil Filter.....	HC-5512	Hydraulic Oil Filter.....	H-5504
545 (FOREST EQUIPMENTS) CAT 3306 (S/N: 2FZ1-UP)		55 (TRACTORS) S/N: 6NN1-UP		561C (PIPE LAYERS) S/N: 85H1-UP	
Hydraulic Oil Filter.....	H-5506	Hydraulic Oil Filter.....	HC-5504	Hydraulic Oil Filter.....	H-5508
Hydraulic Oil Filter.....	HC-5504	55 (TRACTORS) S/N: 7DM1-UP		Hydraulic Oil Filter.....	H-5504
Hydraulic Oil Filter.....	H-5510	Hydraulic Oil Filter.....	HC-5503	561C (PIPE LAYERS) S/N: 92J1-362	
		Hydraulic Oil Filter.....	HC-5504	Hydraulic Oil Filter.....	H-5504



ENGINE APPLICATION

MODEL/APPLICATION	SAKURA NO	MODEL/APPLICATION	SAKURA NO	MODEL/APPLICATION	SAKURA NO
CATERPILLAR		CATERPILLAR		CATERPILLAR	
561C (PIPE LAYERS) S/N: 92J1-UP		572R II (PIPE LAYERS) CAT S/N: 7ZR6828-UP		Hydraulic Oil Filter.....	H-55270
Hydraulic Oil Filter.....	H-5504	Hydraulic Oil Filter.....	H-55280	Hydraulic Oil Filter.....	H-5504
Hydraulic Oil Filter.....	H-5508	Hydraulic Oil Filter.....	H-5510	583 (PIPE LAYERS) S/N: 61A1-119	
561C (PIPE LAYERS) S/N: 92J363-UP		Hydraulic Oil Filter.....	H-5526	Hydraulic Oil Filter.....	H-5504
Hydraulic Oil Filter.....	H-5504	572R II (PIPE LAYERS) CAT S/N: DSC302-UP		Hydraulic Oil Filter.....	H-5503
561C (PIPE LAYERS) w/3306 Eng. (S/N 92J)		Hydraulic Oil Filter.....	H-5526	583 (PIPE LAYERS) S/N: 61A120-UP	
Hydraulic Oil Filter.....	H-55320	Hydraulic Oil Filter.....	H-5510	Hydraulic Oil Filter.....	H-5504
564 (FOREST EQUIPMENTS) CAT S/N: CPT1-UP		Hydraulic Oil Filter.....	H-55280	Hydraulic Oil Filter.....	H-5508
Hydraulic Oil Filter.....	HC-5801	572E (PIPE LAYERS) S/N: 65A1-150		Hydraulic Oil Filter.....	H-5503
Hydraulic Oil Filter.....	HC-5504	Hydraulic Oil Filter.....	H-5504	583 (PIPE LAYERS) S/N: 61A199-UP	
564 (FOREST EQUIPMENTS) CAT S/N: KBN1-UP		572E (PIPE LAYERS) S/N: 65A151-175		Hydraulic Oil Filter.....	H-5503
Hydraulic Oil Filter.....	HC-5801	Hydraulic Oil Filter.....	H-5504	583R (PIPE LAYERS) CAT 3406C	
Hydraulic Oil Filter.....	HC-5504	572E (PIPE LAYERS) S/N: 65A176-UP		Hydraulic Oil Filter.....	H-5510
570 (FOREST EQUIPMENTS) CAT 3126 (S/N: 4XR1-UP)		Hydraulic Oil Filter.....	H-5504	583T (PIPE LAYERS) CAT S/N: CMX1-UP	
Hydraulic Oil Filter.....	HC-5801	572F (PIPE LAYERS) S/N: 96N1-163		Hydraulic Oil Filter.....	H-5526
570B (FOREST EQUIPMENTS) CAT 3126B (S/N: CKG1-UP)		Hydraulic Oil Filter.....	H-5503	Hydraulic Oil Filter.....	H-5506
Hydraulic Oil Filter.....	HC-5801	Hydraulic Oil Filter.....	H-5508	Hydraulic Oil Filter.....	H-55280
571A (PIPE LAYERS) S/N: 64A1-151		572F (PIPE LAYERS) S/N: 96N164-UP		Hydraulic Oil Filter.....	HC-5504
Hydraulic Oil Filter.....	H-5504	Hydraulic Oil Filter.....	H-5508	Hydraulic Oil Filter.....	H-5503
571A (PIPE LAYERS) S/N: 64A152-UP		Hydraulic Oil Filter.....	H-5503	583T (PIPE LAYERS) CAT S/N: LHX1-UP	
Hydraulic Oil Filter.....	H-5504	572G (PIPE LAYERS) S/N: 40U1-UP		Hydraulic Oil Filter.....	H-5526
571F (PIPE LAYERS) S/N: 16W1-UP		Hydraulic Oil Filter.....	H-5503	Hydraulic Oil Filter.....	H-5506
Hydraulic Oil Filter.....	H-5503	Hydraulic Oil Filter.....	H-5508	Hydraulic Oil Filter.....	HC-5504
Hydraulic Oil Filter.....	H-5508	574 (FOREST EQUIPMENTS) CAT 3126 (S/N: 1FM-UP)		Hydraulic Oil Filter.....	H-5503
571F (PIPE LAYERS) S/N: 95N1-190		Hydraulic Oil Filter.....	HC-5504	Hydraulic Oil Filter.....	H-55280
Hydraulic Oil Filter.....	H-5503	574B (FOREST EQUIPMENTS) CAT 3056E (S/N: CZZ1-UP)		583H (PIPE LAYERS) S/N: 61A120-UP	
Hydraulic Oil Filter.....	H-5508	Hydraulic Oil Filter.....	HC-5504	Hydraulic Oil Filter.....	H-5508
571F (PIPE LAYERS) S/N: 95N191-UP		Hydraulic Oil Filter.....	HC-5801	Hydraulic Oil Filter.....	H-5503
Hydraulic Oil Filter.....	H-5503	578 (PIPE LAYERS) S/N: 8HB1-UP		Hydraulic Oil Filter.....	H-5503
571F (PIPE LAYERS) S/N: 95N1-UP		Hydraulic Oil Filter.....	H-5510	583H (PIPE LAYERS) S/N: 61A1-UP	
Hydraulic Oil Filter.....	H-5508	578 (PIPE LAYERS) S/N: 9CA1-UP		Hydraulic Oil Filter.....	H-5503
Hydraulic Oil Filter.....	H-5503	Hydraulic Oil Filter.....	H-5510	Hydraulic Oil Filter.....	H-5508
571G (PIPE LAYERS) S/N: 16W1-UP		580 (FOREST EQUIPMENTS) CAT 3126 (S/N: 7CN1-UP)		583K (PIPE LAYERS) S/N: 78V1-UP	
Hydraulic Oil Filter.....	H-5508	Hydraulic Oil Filter.....	HC-5801	Hydraulic Oil Filter.....	H-5503
Hydraulic Oil Filter.....	H-5503	580B (FOREST EQUIPMENTS) CAT 3126B (S/N: CLT1-UP)		Hydraulic Oil Filter.....	H-5508
572R (PIPE LAYERS) CAT 3306 (S/N: 2HZ-UP)		Hydraulic Oil Filter.....	HC-5801	587T (PIPE LAYERS) CAT S/N: FAT1-UP	
Hydraulic Oil Filter.....	H-5503	583 (PIPE LAYERS) S/N: 16A-16A		Hydraulic Oil Filter.....	H-5526



ENGINE APPLICATION

MODEL/APPLICATION	SAKURA NO	MODEL/APPLICATION	SAKURA NO	MODEL/APPLICATION	SAKURA NO
CATERPILLAR		CATERPILLAR		CATERPILLAR	
587T (PIPE LAYERS) CAT S/N: LHX1-UP		Hydraulic Oil Filter.....	H-55280	615C II (SCRAPERS) S/N: 9XG1-UP	
Hydraulic Oil Filter.....	H-55280	Hydraulic Oil Filter.....	H-5526	Hydraulic Oil Filter.....	H-5509
Hydraulic Oil Filter.....	H-5526	Hydraulic Oil Filter.....	H-5503	Hydraulic Oil Filter.....	H-55270
Hydraulic Oil Filter.....	HC-5504	Hydraulic Oil Filter.....	H-5504		
587R (PIPE LAYERS) CAT S/N: 41Z23000-UP		613 (SCRAPERS)		619C (SCRAPERS) S/N: 61F1-UP	
Hydraulic Oil Filter.....	H-5526	Hydraulic Oil Filter.....	H-55320	Hydraulic Oil Filter.....	H-5503
Hydraulic Oil Filter.....	H-55280	613 (SCRAPERS) S/N: 71M1-1377		619C (SCRAPERS) S/N: 62F1-UP	
Hydraulic Oil Filter.....	HC-5504	Hydraulic Oil Filter.....	H-5503	Hydraulic Oil Filter.....	H-5503
587R (PIPE LAYERS) CAT S/N: BXL1-UP		Hydraulic Oil Filter.....	H-5504	621 (SCRAPERS) S/N: 23H1-UP	
Hydraulic Oil Filter.....	H-5526	613 (SCRAPERS) S/N: 71M1378-UP		Hydraulic Oil Filter.....	H-5503
Hydraulic Oil Filter.....	HC-5504	Hydraulic Oil Filter.....	H-5504	Hydraulic Oil Filter.....	H-5504
Hydraulic Oil Filter.....	H-55280	Hydraulic Oil Filter.....	H-5503	621G (SCRAPERS) S/N: CEN1-UP	
589 (PIPE LAYERS) S/N: 31Z1-UP		613B (SCRAPERS)		Hydraulic Oil Filter.....	HC-5503
Hydraulic Oil Filter.....	H-5509	Hydraulic Oil Filter.....	H-55320	Hydraulic Oil Filter.....	HC-55300
Hydraulic Oil Filter.....	H-55270	613B (SCRAPERS) S/N: 38W1-UP		Hydraulic Oil Filter.....	HC-5506
Hydraulic Oil Filter.....	H-5504	Hydraulic Oil Filter.....	H-5504	Hydraulic Oil Filter.....	HC-5512
591 (PIPE LAYERS)		Hydraulic Oil Filter.....	H-5504	Hydraulic Oil Filter.....	H-5509
Hydraulic Oil Filter.....	H-5504	Hydraulic Oil Filter.....	H-5503	621G (SCRAPERS) S/N: DBB1-UP	
594 (PIPE LAYERS) S/N: 62H1-UP		613C II US (SCRAPERS) CAT 3116 (S/N: 8LJ1-UP)		Hydraulic Oil Filter.....	H-5509
Hydraulic Oil Filter.....	H-5503	Hydraulic Oil Filter.....	H-5503	Hydraulic Oil Filter.....	HC-5506
594G (PIPE LAYERS) S/N: 62H1-UP		Hydraulic Oil Filter.....	H-5504	Hydraulic Oil Filter.....	HC-5503
Hydraulic Oil Filter.....	H-5503	613C II US (SCRAPERS) CAT 3116 (S/N: 93X2780-UP)		Hydraulic Oil Filter.....	HC-55300
594H (PIPE LAYERS) S/N: 96V1-UP		Hydraulic Oil Filter.....	H-5504	Hydraulic Oil Filter.....	HC-5512
Hydraulic Oil Filter.....	H-5503	Hydraulic Oil Filter.....	H-5503	621G (SCRAPERS) w/3406E Eng.	
611 (SCRAPERS) CAT 3306 (S/N: 6SZ1-UP)		615 (SCRAPERS) S/N: 46Z1-1452		Hydraulic Oil Filter.....	H-55320
Hydraulic Oil Filter.....	H-55270	Hydraulic Oil Filter.....	H-55270	621B (SCRAPERS)	
Hydraulic Oil Filter.....	H-5504	615 (SCRAPERS) S/N: 46Z1453-UP		Hydraulic Oil Filter.....	H-55320
Hydraulic Oil Filter.....	H-5509	Hydraulic Oil Filter.....	H-55270	621B (SCRAPERS) S/N: 2DB1-UP	
611 (SCRAPERS) CAT 3306 (S/N: 7WZ1-UP)		Hydraulic Oil Filter.....	H-5504	Hydraulic Oil Filter.....	H-55270
Hydraulic Oil Filter.....	H-5504	615C (SCRAPERS) CAT 3306 (S/N: 2XG1-UP)		Hydraulic Oil Filter.....	H-5509
Hydraulic Oil Filter.....	H-55270	Hydraulic Oil Filter.....	H-5504	Hydraulic Oil Filter.....	H-5504
Hydraulic Oil Filter.....	H-5509	Hydraulic Oil Filter.....	H-5504	621B (SCRAPERS) S/N: 45P1-UP	
613C (SCRAPERS) CAT 3208 (S/N: 92X1-UP)		615C (SCRAPERS) CAT 3306 (S/N: 5TF1-UP)		Hydraulic Oil Filter.....	H-5509
Hydraulic Oil Filter.....	H-5503	Hydraulic Oil Filter.....	H-5504	Hydraulic Oil Filter.....	H-5504
Hydraulic Oil Filter.....	H-5504	Hydraulic Oil Filter.....	H-5509	621B (SCRAPERS) S/N: 6XB1-UP	
613C (SCRAPERS) CAT 3208 (S/N: 93X1-UP)		615C (SCRAPERS) CAT 3306T (S/N: 5TF1-UP)		Hydraulic Oil Filter.....	H-5504
Hydraulic Oil Filter.....	H-5504	Hydraulic Oil Filter.....	H-5509	Hydraulic Oil Filter.....	H-5509
Hydraulic Oil Filter.....	H-5503	Hydraulic Oil Filter.....	H-5504	Hydraulic Oil Filter.....	H-55270
613C SERIES II (SCRAPERS) CAT 3116T (S/N: 8LJ1-UP)		Hydraulic Oil Filter.....	H-5504	621B (SCRAPERS) S/N: 7KC1-UP	
Hydraulic Oil Filter.....	H-55270	Hydraulic Oil Filter.....	H-5504	Hydraulic Oil Filter.....	H-55270
				Hydraulic Oil Filter.....	H-5509
				Hydraulic Oil Filter.....	H-5504



ENGINE APPLICATION

MODEL/APPLICATION	SAKURA NO	MODEL/APPLICATION	SAKURA NO	MODEL/APPLICATION	SAKURA NO
CATERPILLAR		CATERPILLAR		CATERPILLAR	
621B (SCRAPERS) S/N: 8HC1-UP		621F US (SCRAPERS) CAT 3406 (S/N: 5JK1-UP)		623E (SCRAPERS) S/N: 6CB1-UP	
Hydraulic Oil Filter.....	H-5504	Hydraulic Oil Filter.....	H-5509	Hydraulic Oil Filter.....	H-5504
Hydraulic Oil Filter.....	H-5509	Hydraulic Oil Filter.....	H-5504		
Hydraulic Oil Filter.....	H-55270			623E (SCRAPERS) S/N: 6DB1-UP	
621B (SCRAPERS) S/N: 9AC1-UP		621F US (SCRAPERS) CAT 3406C (S/N: 4SK1-UP)		Hydraulic Oil Filter.....	H-5509
Hydraulic Oil Filter.....	H-5504	Hydraulic Oil Filter.....	H-5509	Hydraulic Oil Filter.....	H-5504
Hydraulic Oil Filter.....	H-55270	Hydraulic Oil Filter.....	H-5504		
Hydraulic Oil Filter.....	H-5509	621F US (SCRAPERS) CAT 3406C (S/N: 5JK1-UP)		623E (SCRAPERS) S/N: 6YF1-UP	
621 E (SCRAPERS) S/N: 2PD1-UP		Hydraulic Oil Filter.....	H-5509	Hydraulic Oil Filter.....	H-5504
Hydraulic Oil Filter.....	H-5504	Hydraulic Oil Filter.....	H-5504		
621 E (SCRAPERS) S/N: 6AB1-905		621S (SCRAPERS) S/N: 1TE1-UP		623E (SCRAPERS) w/3406, 3406C Eng.	
Hydraulic Oil Filter.....	H-5509	Hydraulic Oil Filter.....	H-5504	Hydraulic Oil Filter.....	H-55320
Hydraulic Oil Filter.....	H-5504	Hydraulic Oil Filter.....	H-55270		
621 E (SCRAPERS) S/N: 6AB1-UP		621S (SCRAPERS) w/3306 Eng.		623F (SCRAPERS) w/3406, 3406C Eng.	
Hydraulic Oil Filter.....	H-5504	Hydraulic Oil Filter.....	H-55320	Hydraulic Oil Filter.....	H-55320
621 E (SCRAPERS) S/N: 6BB1-UP		623G (SCRAPERS) CAT (S/N: LHX1-UP)		623 (SCRAPERS) S/N: 52U1-UP	
Hydraulic Oil Filter.....	H-5509	Hydraulic Oil Filter.....	H-55270	Hydraulic Oil Filter.....	H-5509
Hydraulic Oil Filter.....	H-5504			Hydraulic Oil Filter.....	H-5504
621 E (SCRAPERS) w/3406 Eng.		623G (SCRAPERS) S/N: 6PY1-UP		624F (LOADERS) S/N: 4YN-UP	
Hydraulic Oil Filter.....	H-55320	Hydraulic Oil Filter.....	H-5504	Hydraulic Oil Filter.....	HC-5504
621F (SCRAPERS) S/N: 4SK1-UP		Hydraulic Oil Filter.....	H-55270	Hydraulic Oil Filter.....	H-5506
Hydraulic Oil Filter.....	H-5504	623G (SCRAPERS) S/N: ARW1-UP		Hydraulic Oil Filter.....	HC-5504
621F (SCRAPERS) w/3406, 3406C Eng.		Hydraulic Oil Filter.....	HC-55300	624F (LOADERS) S/N: 5NN-UP	
Hydraulic Oil Filter.....	H-55320	623G (SCRAPERS) S/N: CE51-UP		Hydraulic Oil Filter.....	H-5506
621F BZ (SCRAPERS) CAT 3406 (S/N: 8PL1-UP)		Hydraulic Oil Filter.....	H-5509	Hydraulic Oil Filter.....	H-5504
Hydraulic Oil Filter.....	H-5504	Hydraulic Oil Filter.....	HC-55300	627G (SCRAPERS) S/N: 3GB1-UP	
Hydraulic Oil Filter.....	H-5509	623G (SCRAPERS) S/N: DBC1-UP		Hydraulic Oil Filter.....	H-55270
621F BZ (SCRAPERS) CAT 3406 (S/N: 9NL1-UP)		Hydraulic Oil Filter.....	H-5509	627G (SCRAPERS) S/N: 3JB1-UP	
Hydraulic Oil Filter.....	H-5509	623G (SCRAPERS) w/3406E Eng.		Hydraulic Oil Filter.....	H-55270
Hydraulic Oil Filter.....	H-5504	Hydraulic Oil Filter.....	H-55320	627G (SCRAPERS) S/N: CEX1-UP	
621F BZ (SCRAPERS) CAT 3406C (S/N: 8PL1-UP)		623B (SCRAPERS)		Hydraulic Oil Filter.....	HC-5503
Hydraulic Oil Filter.....	H-5504	Hydraulic Oil Filter.....	H-55320	Hydraulic Oil Filter.....	H-5509
Hydraulic Oil Filter.....	H-5509	623B (SCRAPERS) S/N: 46P1-UP		Hydraulic Oil Filter.....	HC-5512
621F BZ (SCRAPERS) CAT 3406C (S/N: 9NL1-UP)		Hydraulic Oil Filter.....	H-5504	Hydraulic Oil Filter.....	HC-5506
Hydraulic Oil Filter.....	H-5509	623E (SCRAPERS) S/N: 5SG1-477		Hydraulic Oil Filter.....	HC-55300
Hydraulic Oil Filter.....	H-5504	Hydraulic Oil Filter.....	H-5509	627G (SCRAPERS) S/N: CWK1-UP	
Hydraulic Oil Filter.....	H-5509	623E (SCRAPERS) S/N: 5SG1-477		Hydraulic Oil Filter.....	H-55270
621F US (SCRAPERS) CAT 3406 (S/N: 4SK1-UP)		Hydraulic Oil Filter.....	H-5504	627G (SCRAPERS) S/N: DBD1-UP	
Hydraulic Oil Filter.....	H-5504			Hydraulic Oil Filter.....	H-5509
Hydraulic Oil Filter.....	H-5509				



ENGINE APPLICATION

MODEL/APPLICATION	SAKURA NO	MODEL/APPLICATION	SAKURA NO	MODEL/APPLICATION	SAKURA NO
CATERPILLAR		CATERPILLAR		CATERPILLAR	
627G (SCRAPERS) S/N: DBD1-UP		627E (SCRAPERS) CAT 3406 (S/N: 6FB1-UP)		627E PS (SCRAPERS) S/N: 6EB1-UP	
Hydraulic Oil Filter.....	HC-55300	Hydraulic Oil Filter.....	H-5504	Hydraulic Oil Filter.....	H-5509
Hydraulic Oil Filter.....	HC-5512	Hydraulic Oil Filter.....	H-5509	Hydraulic Oil Filter.....	H-55270
Hydraulic Oil Filter.....	HC-5506			Hydraulic Oil Filter.....	H-5504
Hydraulic Oil Filter.....	HC-5503	627E (SCRAPERS) CAT 3406 (S/N: 6GB1-UP)		627E PS (SCRAPERS) S/N: 6FB1-UP	
		Hydraulic Oil Filter.....	H-5509	Hydraulic Oil Filter.....	H-55270
627G (SCRAPERS) S/N: DRX1-UP		Hydraulic Oil Filter.....	H-5504	Hydraulic Oil Filter.....	H-5504
Hydraulic Oil Filter.....	H-55270				
627G (SCRAPERS) S/N: M1R1-UP		627E (SCRAPERS) w/3306 Eng.		627E PS (SCRAPERS) S/N: 6GB1-UP	
Hydraulic Oil Filter.....	H-55270	Hydraulic Oil Filter.....	H-55320	Hydraulic Oil Filter.....	H-55270
627G (SCRAPERS) w/3406E Eng.		627E (SCRAPERS) w/3406 Eng.		Hydraulic Oil Filter.....	H-5509
Hydraulic Oil Filter.....	H-55320	Hydraulic Oil Filter.....	H-55320	Hydraulic Oil Filter.....	H-5504
627F (SCRAPERS) S/N: 1DL1-UP		627 (SCRAPERS) S/N: 1451-UP		627E PS (SCRAPERS) S/N: 6HB1-UP	
Hydraulic Oil Filter.....	HC-5503	Hydraulic Oil Filter.....	H-5504	Hydraulic Oil Filter.....	H-55270
Hydraulic Oil Filter.....	HC-5506	Hydraulic Oil Filter.....	H-5509	Hydraulic Oil Filter.....	H-5504
Hydraulic Oil Filter.....	H-5509	627 (SCRAPERS) S/N: 1551-UP		630 (SCRAPERS) S/N: 52F-52F	
Hydraulic Oil Filter.....	HC-5512	Hydraulic Oil Filter.....	H-5504	Hydraulic Oil Filter.....	H-5503
627F (SCRAPERS) S/N: 1WE2000-UP		Hydraulic Oil Filter.....	H-5509	630B (SCRAPERS) S/N: 14G1-UP	
Hydraulic Oil Filter.....	H-55270	627 (SCRAPERS) S/N: 54K1451-UP		Hydraulic Oil Filter.....	H-5503
Hydraulic Oil Filter.....	H-5504	Hydraulic Oil Filter.....	H-5504	631 (SCRAPERS) S/N: 51F-UP	
627F (SCRAPERS) S/N: 3GB900-UP		Hydraulic Oil Filter.....	H-5503	Hydraulic Oil Filter.....	H-5503
Hydraulic Oil Filter.....	H-55270	627 (SCRAPERS) S/N: 54K1-736		631 (SCRAPERS) S/N: 67M1-UP	
Hydraulic Oil Filter.....	H-55270	Hydraulic Oil Filter.....	H-5503	Hydraulic Oil Filter.....	H-5509
627F (SCRAPERS) S/N: 3JB500-UP		Hydraulic Oil Filter.....	H-5504	Hydraulic Oil Filter.....	H-5504
Hydraulic Oil Filter.....	H-55270	627 (SCRAPERS) S/N: 54K737-888		631D (SCRAPERS) S/N: 24W1-UP	
Hydraulic Oil Filter.....	H-5504	Hydraulic Oil Filter.....	H-5503	Hydraulic Oil Filter.....	H-5504
Hydraulic Oil Filter.....	H-55270	Hydraulic Oil Filter.....	H-5504	631D (SCRAPERS) S/N: 66W1-UP	
627F (SCRAPERS) w/3406B Eng.		627 (SCRAPERS) S/N: 54K889-1450		Hydraulic Oil Filter.....	H-5504
Hydraulic Oil Filter.....	H-55320	Hydraulic Oil Filter.....	H-5503	631D (SCRAPERS) w/3408 Eng.	
627B (SCRAPERS) S/N: 37V1-UP		627 (SCRAPERS) S/N: 68M1551-UP		Hydraulic Oil Filter.....	H-55320
Hydraulic Oil Filter.....	H-5504	Hydraulic Oil Filter.....	H-5504	631E II (SCRAPERS) S/N: 1AB1446-1509-UP	
627B (SCRAPERS) S/N: 38V1-UP		627 (SCRAPERS) S/N: 68M1-650		Hydraulic Oil Filter.....	H-5509
Hydraulic Oil Filter.....	H-5504	Hydraulic Oil Filter.....	H-5503	Hydraulic Oil Filter.....	HC-5503
627B (SCRAPERS) w/3306 Eng.		627 (SCRAPERS) S/N: 68M651-878		Hydraulic Oil Filter.....	HC-5512
Hydraulic Oil Filter.....	H-55320	Hydraulic Oil Filter.....	H-5503	Hydraulic Oil Filter.....	HC-5506
627E (SCRAPERS) CAT 3406 (S/N: 6EB1-UP)		Hydraulic Oil Filter.....	H-5504	Hydraulic Oil Filter.....	HC-55310
Hydraulic Oil Filter.....	H-5504	627B TR (SCRAPERS) S/N: 1551-UP		631E II (SCRAPERS) S/N: 1AB1510-1575-UP	
Hydraulic Oil Filter.....	H-5509	Hydraulic Oil Filter.....	H-5504	Hydraulic Oil Filter.....	HC-5503
				Hydraulic Oil Filter.....	HC-5512
				Hydraulic Oil Filter.....	HC-5506
				Hydraulic Oil Filter.....	H-5509



ENGINE APPLICATION

MODEL/APPLICATION	SAKURA NO	MODEL/APPLICATION	SAKURA NO	MODEL/APPLICATION	SAKURA NO
CATERPILLAR		CATERPILLAR		CATERPILLAR	
631E II (SCRAPERS) S/N: 1AB1510-1575-UP Hydraulic Oil Filter..... HC-55310		631G (SCRAPERS) S/N: DFA1-UP Hydraulic Oil Filter..... HC-5512 Hydraulic Oil Filter..... HC-5503 Hydraulic Oil Filter..... HC-55300 Hydraulic Oil Filter..... H-5509 Hydraulic Oil Filter..... HC-5506		631E (SCRAPERS) S/N: 1NB1-389 Hydraulic Oil Filter..... H-5504	
631E II (SCRAPERS) S/N: 1AB1576-1639-UP Hydraulic Oil Filter..... HC-5503 Hydraulic Oil Filter..... HC-5506 Hydraulic Oil Filter..... H-5509 Hydraulic Oil Filter..... HC-5512 Hydraulic Oil Filter..... HC-55310		631G (SCRAPERS) w/3408E Eng. Hydraulic Oil Filter..... H-55320		631E (SCRAPERS) S/N: 3ND1-UP Hydraulic Oil Filter..... H-5504	
631E II (SCRAPERS) S/N: 1AB1640-UP Hydraulic Oil Filter..... HC-55310 Hydraulic Oil Filter..... H-5509 Hydraulic Oil Filter..... HC-5512 Hydraulic Oil Filter..... HC-5503 Hydraulic Oil Filter..... HC-5506		631B (SCRAPERS) S/N: 13G1-3686 Hydraulic Oil Filter..... H-5503		631E (SCRAPERS) S/N: 4LD1-UP Hydraulic Oil Filter..... H-5504	
631E II (SCRAPERS) S/N: 1AB1-855-UP Hydraulic Oil Filter..... H-5509		631B (SCRAPERS) S/N: 13G3687-UP Hydraulic Oil Filter..... H-5503		631E (SCRAPERS) S/N: 4LD1-UP Hydraulic Oil Filter..... H-5503	
631E II (SCRAPERS) S/N: 1AB856-1445-UP Hydraulic Oil Filter..... H-5509		631C (SCRAPERS) Hydraulic Oil Filter..... H-55320		632 (SCRAPERS) S/N: 14G-14G Hydraulic Oil Filter..... H-5503	
631E II (SCRAPERS) S/N: 3TE1-UP Hydraulic Oil Filter..... H-55270 Hydraulic Oil Filter..... H-5504		631C (SCRAPERS) S/N: 67M1-4259 Hydraulic Oil Filter..... H-5504		632 (SCRAPERS) S/N: 14G1-UP Hydraulic Oil Filter..... H-5503	
631E II (SCRAPERS) S/N: 8TA1-UP Hydraulic Oil Filter..... H-55270 Hydraulic Oil Filter..... H-5504		631C (SCRAPERS) S/N: 67M4260-UP Hydraulic Oil Filter..... H-5504		633 (SCRAPERS) S/N: 44J1-UP Hydraulic Oil Filter..... H-5503	
631E II (SCRAPERS) S/N: 9PE1-UP Hydraulic Oil Filter..... H-55270 Hydraulic Oil Filter..... H-5504		631E (SCRAPERS) S/N: 1AB1-1639 Hydraulic Oil Filter..... H-5504		633 (SCRAPERS) S/N: 66M1-781 Hydraulic Oil Filter..... H-5503	
631G (SCRAPERS) CAT S/N: 5XD1-UP , 2007-UP Hydraulic Oil Filter..... HC-5506 Hydraulic Oil Filter..... HC-5503 Hydraulic Oil Filter..... HC-5512		631E (SCRAPERS) S/N: 1AB1510-1575 Hydraulic Oil Filter..... HC-5506 Hydraulic Oil Filter..... HC-55310 Hydraulic Oil Filter..... H-5509 Hydraulic Oil Filter..... HC-5512 Hydraulic Oil Filter..... HC-5503		633 (SCRAPERS) S/N: 66M782-UP Hydraulic Oil Filter..... H-5504 Hydraulic Oil Filter..... H-5509	
631G (SCRAPERS) CAT S/N: AWK1-UP , 2007-UP Hydraulic Oil Filter..... HC-5503 Hydraulic Oil Filter..... HC-5512 Hydraulic Oil Filter..... HC-5506		631E (SCRAPERS) S/N: 1AB1576-1639 Hydraulic Oil Filter..... HC-5506 Hydraulic Oil Filter..... H-5509 Hydraulic Oil Filter..... HC-55310 Hydraulic Oil Filter..... HC-5503 Hydraulic Oil Filter..... HC-5512		633D (SCRAPERS) S/N: 25W1-UP Hydraulic Oil Filter..... H-5504	
631G (SCRAPERS) S/N: CLR1-UP Hydraulic Oil Filter..... HC-5506 Hydraulic Oil Filter..... HC-5512 Hydraulic Oil Filter..... HC-5503 Hydraulic Oil Filter..... HC-55300 Hydraulic Oil Filter..... H-5509		631E (SCRAPERS) S/N: 1AB1640-UP Hydraulic Oil Filter..... HC-55310 Hydraulic Oil Filter..... H-5509 Hydraulic Oil Filter..... HC-5503 Hydraulic Oil Filter..... HC-5512 Hydraulic Oil Filter..... HC-5506		633D (SCRAPERS) w/3408 Eng. Hydraulic Oil Filter..... H-55320	
		631E (SCRAPERS) S/N: 1AB1-855 Hydraulic Oil Filter..... H-5509		633E II (SCRAPERS) S/N: 2PS1-UP Hydraulic Oil Filter..... HC-5503 Hydraulic Oil Filter..... HC-5506 Hydraulic Oil Filter..... HC-5512 Hydraulic Oil Filter..... H-5509	
				633E II (SCRAPERS) S/N: 9PE1-UP Hydraulic Oil Filter..... H-55270 Hydraulic Oil Filter..... H-5504	
				633C (SCRAPERS) S/N: 66M1-UP Hydraulic Oil Filter..... H-5504	
				633E (SCRAPERS) Hydraulic Oil Filter..... H-55320	



ENGINE APPLICATION

MODEL/APPLICATION	SAKURA NO	MODEL/APPLICATION	SAKURA NO	MODEL/APPLICATION	SAKURA NO
CATERPILLAR		CATERPILLAR		CATERPILLAR	
633E (SCRAPERS) S/N: 1EB1-309		Hydraulic Oil Filter.....	H-5504	637 (SCRAPERS) S/N: 65M1-UP	
Hydraulic Oil Filter.....	HC-5503	Hydraulic Oil Filter.....	H-55270	Hydraulic Oil Filter.....	H-5504
637G (SCRAPERS) CAT 3408E (S/N: AWE1-UP)		637E (SCRAPERS) S/N: 1HB1-809		Hydraulic Oil Filter.....	H-5503
Hydraulic Oil Filter.....	H-5504	Hydraulic Oil Filter.....	H-5504	637 (SCRAPERS) S/N: 79P1-UP	
Hydraulic Oil Filter.....	H-55270	637E (SCRAPERS) S/N: 1LB1-UP		Hydraulic Oil Filter.....	H-5504
637G (SCRAPERS) CAT 3408E (S/N: AYN1-UP)		Hydraulic Oil Filter.....	H-5504	Hydraulic Oil Filter.....	H-5503
Hydraulic Oil Filter.....	H-5504	637E (SCRAPERS) S/N: 7CB1-179		637 (SCRAPERS) S/N: 91N1-373	
Hydraulic Oil Filter.....	H-55270	Hydraulic Oil Filter.....	H-55270	Hydraulic Oil Filter.....	H-5504
637G (SCRAPERS) S/N: CEH1-UP		Hydraulic Oil Filter.....	H-5504	637 (SCRAPERS) S/N: 91N374-UP	
Hydraulic Oil Filter.....	H-5509	637E (SCRAPERS) w/3408, 3408E Engs.		Hydraulic Oil Filter.....	H-5504
Hydraulic Oil Filter.....	HC-55300	Hydraulic Oil Filter.....	H-55320	637 (SCRAPERS) S/N: 92N1-204	
Hydraulic Oil Filter.....	HC-5506	637E II (SCRAPERS) S/N: 1FB1-354-UP		Hydraulic Oil Filter.....	H-5504
Hydraulic Oil Filter.....	HC-5512	Hydraulic Oil Filter.....	H-5509	637 (SCRAPERS) S/N: 92N205-UP	
Hydraulic Oil Filter.....	HC-5503	637E II (SCRAPERS) S/N: 1FB355-570-UP		Hydraulic Oil Filter.....	H-5504
637G (SCRAPERS) S/N: DFJ1-UP		Hydraulic Oil Filter.....	H-5509	637D TR (SCRAPERS) S/N: 27W1-UP	
Hydraulic Oil Filter.....	H-5509	637E II (SCRAPERS) S/N: 1FB571-633-UP		Hydraulic Oil Filter.....	H-5504
Hydraulic Oil Filter.....	HC-55300	Hydraulic Oil Filter.....	H-5509	639D SCRAPER (SCRAPERS) S/N: 99X1-UP	
Hydraulic Oil Filter.....	HC-5506	637E II (SCRAPERS) S/N: 1FB634-659-UP		Hydraulic Oil Filter.....	H-5504
Hydraulic Oil Filter.....	HC-5503	Hydraulic Oil Filter.....	H-5509	641 (SCRAPERS) S/N: 41M1-UP	
Hydraulic Oil Filter.....	HC-5512	637E II (SCRAPERS) S/N: 1FB660-UP		Hydraulic Oil Filter.....	H-5503
637G (SCRAPERS) w/3408E Eng.		Hydraulic Oil Filter.....	HC-5506	641 (SCRAPERS) S/N: 64F1-UP	
Hydraulic Oil Filter.....	H-55320	Hydraulic Oil Filter.....	HC-5503	Hydraulic Oil Filter.....	H-5503
637G (SCRAPERS) w/C18 Eng.		Hydraulic Oil Filter.....	HC-5512	Hydraulic Oil Filter.....	H-5503
Hydraulic Oil Filter.....	H-55320	Hydraulic Oil Filter.....	H-5509	641B (SCRAPERS) S/N: 65K1-900	
637D (SCRAPERS) S/N: 20W1-UP		637E II (SCRAPERS) S/N: 3HB1-UP		Hydraulic Oil Filter.....	H-5503
Hydraulic Oil Filter.....	H-5504	Hydraulic Oil Filter.....	H-55270	Hydraulic Oil Filter.....	H-5504
637D (SCRAPERS) S/N: 22W1-UP		637E II (SCRAPERS) S/N: 3KB1-UP		641B (SCRAPERS) S/N: 65K901-UP	
Hydraulic Oil Filter.....	H-5504	Hydraulic Oil Filter.....	H-55270	Hydraulic Oil Filter.....	H-5503
637D (SCRAPERS) S/N: 26W1-UP		637E II (SCRAPERS) S/N: 9PE1-UP		Hydraulic Oil Filter.....	H-5504
Hydraulic Oil Filter.....	H-5504	Hydraulic Oil Filter.....	H-55270	641B (SCRAPERS) w/D346 Eng.	
637D (SCRAPERS) S/N: 47B1-UP		Hydraulic Oil Filter.....	H-5504	Hydraulic Oil Filter.....	H-55320
Hydraulic Oil Filter.....	H-55270	637 (SCRAPERS)		650 (SCRAPERS) S/N: 58K1-354	
Hydraulic Oil Filter.....	H-5504	Hydraulic Oil Filter.....	H-55320	Hydraulic Oil Filter.....	H-5503
637E (SCRAPERS) S/N: 1FB1-UP		637 (SCRAPERS) S/N: 63M305-UP		Hydraulic Oil Filter.....	H-5504
Hydraulic Oil Filter.....	H-5504	Hydraulic Oil Filter.....	H-5504	650 (SCRAPERS) S/N: 58K355-UP	
637E (SCRAPERS) S/N: 1HB1-690		637 (SCRAPERS) S/N: 64M1-UP		Hydraulic Oil Filter.....	H-5504
Hydraulic Oil Filter.....	H-5504	Hydraulic Oil Filter.....	H-5504	Hydraulic Oil Filter.....	H-5503



ENGINE APPLICATION

MODEL/APPLICATION	SAKURA NO	MODEL/APPLICATION	SAKURA NO	MODEL/APPLICATION	SAKURA NO
CATERPILLAR		CATERPILLAR		CATERPILLAR	
650 (SCRAPERS) S/N: 63F1-UP Hydraulic Oil Filter.....	H-5503	Hydraulic Oil Filter.....	H-5503	657B (SCRAPERS) S/N: 68K827-UP Hydraulic Oil Filter.....	H-5503
650 (SCRAPERS) S/N: 77F1-UP Hydraulic Oil Filter.....	H-5503	657E (SCRAPERS) CAT 3412 TA (S/N: 86Z1-UP) Hydraulic Oil Filter.....	H-5504	Hydraulic Oil Filter.....	H-5504
650B (SCRAPERS) Hydraulic Oil Filter.....	H-55320	657E (SCRAPERS) CAT 3412 TA (S/N: 87Z1-UP) Hydraulic Oil Filter.....	H-5504	Hydraulic Oil Filter.....	H-55270
651 (SCRAPERS) S/N: 33G1-UP Hydraulic Oil Filter.....	H-5503	657E (SCRAPERS) S/N: 6PR1-UP Hydraulic Oil Filter.....	H-5504	657B (SCRAPERS) S/N: 68K829-UP Hydraulic Oil Filter.....	H-5503
651 (SCRAPERS) S/N: 44M1-UP Hydraulic Oil Filter.....	H-5503	Hydraulic Oil Filter.....	H-55270	Hydraulic Oil Filter.....	H-5504
651E (SCRAPERS) CAT 3412 (S/N: 88Z1-UP) Hydraulic Oil Filter.....	H-5503	657E (SCRAPERS) S/N: 6TR1-226-UP Hydraulic Oil Filter.....	HC-55300	657B (SCRAPERS) w/D346 Eng. Hydraulic Oil Filter.....	H-55320
651E (SCRAPERS) CAT 3412 (S/N: 89Z1-UP) Hydraulic Oil Filter.....	H-5503	657E (SCRAPERS) S/N: 6TR227-UP Hydraulic Oil Filter.....	HC-55300	657 (SCRAPERS) S/N: 19G1-UP Hydraulic Oil Filter.....	H-5503
651E (SCRAPERS) CAT 3412E (S/N: 88Z1-UP) Hydraulic Oil Filter.....	H-5503	657E (SCRAPERS) S/N: 90Z1-UP Hydraulic Oil Filter.....	H-5503	657 (SCRAPERS) S/N: 31G1-UP Hydraulic Oil Filter.....	H-5503
651E (SCRAPERS) CAT 3412E (S/N: 89Z1-UP) Hydraulic Oil Filter.....	H-5503	657E (SCRAPERS) S/N: 91Z1-UP Hydraulic Oil Filter.....	H-5503	657 (SCRAPERS) S/N: 46M1-UP Hydraulic Oil Filter.....	H-5503
651B (SCRAPERS) S/N: 67K1-508 Hydraulic Oil Filter.....	H-5504	657G (SCRAPERS) S/N: A4G1-UP Hydraulic Oil Filter.....	HC-55300	657 (SCRAPERS) S/N: 86Z1-87Z1 Hydraulic Oil Filter.....	H-5504
Hydraulic Oil Filter.....	H-5503	Hydraulic Oil Filter.....	HC-5503	Hydraulic Oil Filter.....	H-5504
651B (SCRAPERS) S/N: 67K509-UP Hydraulic Oil Filter.....	H-5504	Hydraulic Oil Filter.....	HC-5512	657 (SCRAPERS) S/N: 90Z1-91Z1 Hydraulic Oil Filter.....	H-5503
Hydraulic Oil Filter.....	H-5503	Hydraulic Oil Filter.....	HC-5506	65B (TRACTORS) S/N: 7YC1-1116-UP Hydraulic Oil Filter.....	HC-5506
651B (SCRAPERS) w/D346 Eng. Hydraulic Oil Filter.....	H-55320	657G (SCRAPERS) S/N: DRM1-UP Hydraulic Oil Filter.....	H-5503	Hydraulic Oil Filter.....	HC-5503
657E (SCRAPERS) CAT 3408 TA (S/N: 6MB1-UP) Hydraulic Oil Filter.....	H-5503	Hydraulic Oil Filter.....	H-55280	Hydraulic Oil Filter.....	HC-5508
Hydraulic Oil Filter.....	H-5504	Hydraulic Oil Filter.....	H-5526	Hydraulic Oil Filter.....	HC-5512
657E (SCRAPERS) CAT 3408 TA (S/N: 86Z1-UP) Hydraulic Oil Filter.....	H-5504	657G (SCRAPERS) S/N: LMH1-UP Hydraulic Oil Filter.....	H-5526	65B (TRACTORS) S/N: 7YC1117-UP Hydraulic Oil Filter.....	HC-5512
Hydraulic Oil Filter.....	H-5504	Hydraulic Oil Filter.....	H-55280	Hydraulic Oil Filter.....	HC-5503
657E (SCRAPERS) CAT 3408 TA (S/N: 87Z1-UP) Hydraulic Oil Filter.....	H-5504	Hydraulic Oil Filter.....	H-5503	Hydraulic Oil Filter.....	HC-5508
Hydraulic Oil Filter.....	H-5504	657G (SCRAPERS) S/N: W1B1-UP Hydraulic Oil Filter.....	HC-55300	Hydraulic Oil Filter.....	HC-5506
657E (SCRAPERS) CAT 3408 TA (S/N: 87Z1-UP) Hydraulic Oil Filter.....	H-5504	657G (SCRAPERS) S/N: W1C1-UP Hydraulic Oil Filter.....	HC-55300	65C (TRACTORS) S/N: 2ZJ1-499-UP Hydraulic Oil Filter.....	HC-5512
Hydraulic Oil Filter.....	H-5504	657B (SCRAPERS) S/N: 68K1-826 Hydraulic Oil Filter.....	H-5504	Hydraulic Oil Filter.....	HC-5506
657E (SCRAPERS) CAT 3412 TA (S/N: 6MB1-UP) Hydraulic Oil Filter.....	H-5504	Hydraulic Oil Filter.....	H-5503	Hydraulic Oil Filter.....	HC-5503
Hydraulic Oil Filter.....	H-5504	657B (SCRAPERS) S/N: 2ZJ500-UP Hydraulic Oil Filter.....	HC-5506	Hydraulic Oil Filter.....	HC-5506
		Hydraulic Oil Filter.....	HC-5506	Hydraulic Oil Filter.....	HC-5506
		657B (TRACTORS) S/N: 2ZJ1000-UP Hydraulic Oil Filter.....	HC-5512	Hydraulic Oil Filter.....	HC-5506
		Hydraulic Oil Filter.....	HC-5503	Hydraulic Oil Filter.....	HC-5506
		65D (TRACTORS) S/N: 2ZJ1000-UP Hydraulic Oil Filter.....	HC-5512	Hydraulic Oil Filter.....	HC-5506
		Hydraulic Oil Filter.....	HC-5503	Hydraulic Oil Filter.....	HC-5506



ENGINE APPLICATION

MODEL/APPLICATION	SAKURA NO	MODEL/APPLICATION	SAKURA NO	MODEL/APPLICATION	SAKURA NO
CATERPILLAR		CATERPILLAR		CATERPILLAR	
65D (TRACTORS) S/N: 2ZJ1000-UP		Hydraulic Oil Filter.....	H-5503	Hydraulic Oil Filter.....	HC-5507
Hydraulic Oil Filter.....	HC-5506	666B (SCRAPERS) S/N: 66K227-UP		730 (DUMP TRUCKS) CAT C11	
65D (TRACTORS) S/N: 2ZJ1-999-UP		Hydraulic Oil Filter.....	H-5504	Hydraulic Oil Filter.....	HC-5507
Hydraulic Oil Filter.....	HC-5506	Hydraulic Oil Filter.....	H-5503	Hydraulic Oil Filter.....	H-5526
Hydraulic Oil Filter.....	HC-5512	70C (TRACTORS) S/N: 2YL1-UP		730 (DUMP TRUCKS) S/N: AGF1092-1491	
Hydraulic Oil Filter.....	HC-5503	Hydraulic Oil Filter.....	HC-5506	Hydraulic Oil Filter.....	HC-55220
65E (TRACTORS) S/N: 1GM1-UP		Hydraulic Oil Filter.....	HC-5512	Hydraulic Oil Filter.....	HC-5507
Hydraulic Oil Filter.....	HC-5512	725 (DUMP TRUCKS) CAT 3176C		Hydraulic Oil Filter.....	H-5526
Hydraulic Oil Filter.....	HC-5506	Hydraulic Oil Filter.....	H-5526	Hydraulic Oil Filter.....	H-55280
Hydraulic Oil Filter.....	HC-5503	Hydraulic Oil Filter.....	HC-5507	730 (DUMP TRUCKS) S/N: AGF1-1091	
Hydraulic Oil Filter.....	HC-5512	725 (DUMP TRUCKS) CAT C11		Hydraulic Oil Filter.....	H-5526
65E (TRACTORS) S/N: 6GS1-UP		Hydraulic Oil Filter.....	H-5526	Hydraulic Oil Filter.....	HC-55220
Hydraulic Oil Filter.....	HC-5506	Hydraulic Oil Filter.....	HC-5507	Hydraulic Oil Filter.....	H-55280
Hydraulic Oil Filter.....	HC-5503	725 (DUMP TRUCKS) S/N: AFX1-1178		Hydraulic Oil Filter.....	HC-5507
Hydraulic Oil Filter.....	HC-5512	Hydraulic Oil Filter.....	H-5526	Hydraulic Oil Filter.....	H-5503
660 (SCRAPERS) S/N: 58K1-354		Hydraulic Oil Filter.....	H-55280	730 (DUMP TRUCKS) S/N: AGF1492-UP	
Hydraulic Oil Filter.....	H-5503	Hydraulic Oil Filter.....	HC-5507	Hydraulic Oil Filter.....	HC-55220
Hydraulic Oil Filter.....	H-5504	Hydraulic Oil Filter.....	HC-55220	Hydraulic Oil Filter.....	HC-5507
660 (SCRAPERS) S/N: 58K355-UP		Hydraulic Oil Filter.....	HC-5507	Hydraulic Oil Filter.....	H-55280
Hydraulic Oil Filter.....	H-5503	Hydraulic Oil Filter.....	HC-55220	Hydraulic Oil Filter.....	H-5526
Hydraulic Oil Filter.....	H-5504	725 (DUMP TRUCKS) S/N: AFX1179-1582		730 (DUMP TRUCKS) S/N: B1M1-410	
660 (SCRAPERS) S/N: 77F1-UP		Hydraulic Oil Filter.....	HC-5507	Hydraulic Oil Filter.....	H-5526
Hydraulic Oil Filter.....	H-5503	Hydraulic Oil Filter.....	H-5526	Hydraulic Oil Filter.....	HC-5507
660B (SCRAPERS)		Hydraulic Oil Filter.....	HC-55220	Hydraulic Oil Filter.....	H-55280
Hydraulic Oil Filter.....	H-55320	Hydraulic Oil Filter.....	H-55280	Hydraulic Oil Filter.....	HC-55220
666 (SCRAPERS) S/N: 18G1-UP		Hydraulic Oil Filter.....	H-5503	730 (DUMP TRUCKS) S/N: B1M411-630	
Hydraulic Oil Filter.....	H-5503	725 (DUMP TRUCKS) S/N: AFX1583-UP		Hydraulic Oil Filter.....	H-5526
666 (SCRAPERS) S/N: 20G1-241		Hydraulic Oil Filter.....	H-5526	Hydraulic Oil Filter.....	HC-5504
Hydraulic Oil Filter.....	H-5503	Hydraulic Oil Filter.....	HC-55220	Hydraulic Oil Filter.....	H-55280
666 (SCRAPERS) S/N: 32G1-UP		Hydraulic Oil Filter.....	H-5503	730 (DUMP TRUCKS) S/N: B1W1-184	
Hydraulic Oil Filter.....	H-5503	Hydraulic Oil Filter.....	H-55280	Hydraulic Oil Filter.....	H-55280
666 (SCRAPERS) S/N: 64H1-UP		Hydraulic Oil Filter.....	H-5503	Hydraulic Oil Filter.....	HC-5507
Hydraulic Oil Filter.....	H-5503	725 (DUMP TRUCKS) S/N: B1L1-504		Hydraulic Oil Filter.....	H-5526
666 (SCRAPERS) S/N: 77F1-UP		Hydraulic Oil Filter.....	HC-5507	Hydraulic Oil Filter.....	HC-55220
Hydraulic Oil Filter.....	H-5503	Hydraulic Oil Filter.....	HC-55220	Hydraulic Oil Filter.....	H-55280
666B (SCRAPERS) S/N: 66K1-226		Hydraulic Oil Filter.....	H-5526	730 (DUMP TRUCKS) S/N: B1W185-196	
Hydraulic Oil Filter.....	H-55280	Hydraulic Oil Filter.....	H-5503	Hydraulic Oil Filter.....	H-55280
Hydraulic Oil Filter.....	H-55270	725 (DUMP TRUCKS) S/N: B1L505-711		Hydraulic Oil Filter.....	H-5526
Hydraulic Oil Filter.....	H-5504	Hydraulic Oil Filter.....	HC-5504	Hydraulic Oil Filter.....	HC-5504
666B (SCRAPERS) S/N: 66K1-226		Hydraulic Oil Filter.....	H-55280	735 (DUMP TRUCKS) CAT 3406E	
Hydraulic Oil Filter.....	H-55280	730 (DUMP TRUCKS) CAT 3196C		Hydraulic Oil Filter.....	HC-5507
Hydraulic Oil Filter.....	H-55270	Hydraulic Oil Filter.....	H-5526	Hydraulic Oil Filter.....	H-5526
Hydraulic Oil Filter.....	H-5504	Hydraulic Oil Filter.....	H-5526	735 (DUMP TRUCKS) CAT C15	
		Hydraulic Oil Filter.....	H-5526	Hydraulic Oil Filter.....	HC-5507
				Hydraulic Oil Filter.....	H-5526



ENGINE APPLICATION

MODEL/APPLICATION	SAKURA NO	MODEL/APPLICATION	SAKURA NO	MODEL/APPLICATION	SAKURA NO
CATERPILLAR		CATERPILLAR		CATERPILLAR	
735 (DUMP TRUCKS) S/N: ANR1-856		Hydraulic Oil Filter.....	H-55280	Hydraulic Oil Filter.....	HC-5511
Hydraulic Oil Filter.....	HC-5507	Hydraulic Oil Filter.....	H-5526	769D (CONSTRUCTION & MINING) CAT 3408E (S/N: STR-UP)	
Hydraulic Oil Filter.....	H-5526	Hydraulic Oil Filter.....	HC-55220	Hydraulic Oil Filter.....	HC-5511
Hydraulic Oil Filter.....	H-55280	75 (TRACTORS) CAT S/N: 43Z1-UP		Hydraulic Oil Filter.....	HC-5504
735 (DUMP TRUCKS) S/N: ANR857-UP		Hydraulic Oil Filter.....	HC-5508	Hydraulic Oil Filter.....	H-5503
Hydraulic Oil Filter.....	H-55280	Hydraulic Oil Filter.....	HC-5512	769D (CONSTRUCTION & MINING) CAT 3408E (S/N: BBB-UP)	
Hydraulic Oil Filter.....	HC-55220	Hydraulic Oil Filter.....	HC-5506	Hydraulic Oil Filter.....	HC-5511
Hydraulic Oil Filter.....	H-5526	Hydraulic Oil Filter.....	HC-5503	Hydraulic Oil Filter.....	H-5503
Hydraulic Oil Filter.....	HC-5507	Hydraulic Oil Filter.....	HC-5503	Hydraulic Oil Filter.....	HC-5504
735 (DUMP TRUCKS) S/N: B1N1-436		Hydraulic Oil Filter.....	HC-5508	769D (CONSTRUCTION & MINING) CAT 3408E TA-HEUI (S/N: 5SS1-UP)	
Hydraulic Oil Filter.....	HC-5507	Hydraulic Oil Filter.....	HC-5512	Hydraulic Oil Filter.....	HC-5516
Hydraulic Oil Filter.....	H-55280	75C (TRACTORS) S/N: 4KK1-499-UP		Hydraulic Oil Filter.....	HC-55300
Hydraulic Oil Filter.....	H-55280	Hydraulic Oil Filter.....	HC-5506	Hydraulic Oil Filter.....	HC-55170
Hydraulic Oil Filter.....	HC-55220	Hydraulic Oil Filter.....	HC-5503	Hydraulic Oil Filter.....	HC-5505
Hydraulic Oil Filter.....	H-5526	Hydraulic Oil Filter.....	HC-5512	Hydraulic Oil Filter.....	HC-5504
740 (DUMP TRUCKS) CAT 3406E		Hydraulic Oil Filter.....	HC-5503	769D (CONSTRUCTION & MINING) CAT 3408E TA-HEUI (S/N: 5TR1-504)	
Hydraulic Oil Filter.....	H-5504	Hydraulic Oil Filter.....	HC-5512	Hydraulic Oil Filter.....	HC-5516
Hydraulic Oil Filter.....	HC-5507	Hydraulic Oil Filter.....	HC-5506	Hydraulic Oil Filter.....	HC-5504
Hydraulic Oil Filter.....	H-55270	Hydraulic Oil Filter.....	HC-5503	Hydraulic Oil Filter.....	HC-55300
Hydraulic Oil Filter.....	H-5526	75D (TRACTORS) CAT S/N: 5AR1-UP		769D (CONSTRUCTION & MINING) CAT 3408E TA-HEUI (S/N: 5TR1-UP)	
740 (DUMP TRUCKS) CAT C15		Hydraulic Oil Filter.....	HC-5512	Hydraulic Oil Filter.....	H-5503
Hydraulic Oil Filter.....	H-5504	Hydraulic Oil Filter.....	HC-5503	769D (CONSTRUCTION & MINING) CAT 3408E TA-HEUI (S/N: 5TR505-UP)	
Hydraulic Oil Filter.....	HC-5507	Hydraulic Oil Filter.....	HC-5506	Hydraulic Oil Filter.....	H-5504
Hydraulic Oil Filter.....	H-5526	Hydraulic Oil Filter.....	HC-5506	Hydraulic Oil Filter.....	H-5526
740 (DUMP TRUCKS) S/N: AXM1-UP		Hydraulic Oil Filter.....	HC-5503	Hydraulic Oil Filter.....	H-55270
Hydraulic Oil Filter.....	H-55270	75D (TRACTORS) CAT S/N: 7ZR1-UP		Hydraulic Oil Filter.....	H-5503
Hydraulic Oil Filter.....	HC-5507	Hydraulic Oil Filter.....	HC-5503	Hydraulic Oil Filter.....	H-55280
Hydraulic Oil Filter.....	HC-55220	Hydraulic Oil Filter.....	HC-5506	769D (CONSTRUCTION & MINING) CAT 3408E TA-HEUI (S/N: BBB1-UP)	
Hydraulic Oil Filter.....	H-55280	Hydraulic Oil Filter.....	HC-5512	Hydraulic Oil Filter.....	HC-55170
Hydraulic Oil Filter.....	H-5526	75E (TRACTORS) S/N: 1HM1-UP		Hydraulic Oil Filter.....	HC-5505
Hydraulic Oil Filter.....	HC-5507	Hydraulic Oil Filter.....	HC-5506	Hydraulic Oil Filter.....	HC-55300
740 (DUMP TRUCKS) S/N: AZZ1-UP		Hydraulic Oil Filter.....	HC-5512	Hydraulic Oil Filter.....	HC-5516
Hydraulic Oil Filter.....	H-55280	Hydraulic Oil Filter.....	HC-5503	Hydraulic Oil Filter.....	HC-5504
Hydraulic Oil Filter.....	HC-55220	Hydraulic Oil Filter.....	HC-5503	769 (CONSTRUCTION & MINING) S/N: 1X1-UP	
Hydraulic Oil Filter.....	H-55270	75E (TRACTORS) S/N: 6HS1-UP		Hydraulic Oil Filter.....	H-5504
Hydraulic Oil Filter.....	H-5526	Hydraulic Oil Filter.....	HC-5506	Hydraulic Oil Filter.....	H-5503
Hydraulic Oil Filter.....	HC-5507	Hydraulic Oil Filter.....	HC-5512	769 (CONSTRUCTION & MINING) S/N: 99F1-1229	
740 (DUMP TRUCKS) S/N: B1P1-1073		Hydraulic Oil Filter.....	HC-5503	Hydraulic Oil Filter.....	H-55280
Hydraulic Oil Filter.....	H-55280	769D (CONSTRUCTION & MINING) CAT 3408E (S/N: 5TR1-504) , 2005-UP		Hydraulic Oil Filter.....	H-5503
Hydraulic Oil Filter.....	HC-55220	Hydraulic Oil Filter.....	HC-5516	769 (CONSTRUCTION & MINING) S/N: 99F1230-UP	
Hydraulic Oil Filter.....	H-55270	Hydraulic Oil Filter.....	HC-5511	Hydraulic Oil Filter.....	H-5503
Hydraulic Oil Filter.....	H-5526	Hydraulic Oil Filter.....	HC-5504	769 (CONSTRUCTION & MINING) S/N: 99F1231-1237	
Hydraulic Oil Filter.....	HC-5507	769D (CONSTRUCTION & MINING) CAT 3408E (S/N: 5SS-UP)		Hydraulic Oil Filter.....	H-55280
740 (DUMP TRUCKS) S/N: B1R1-219		Hydraulic Oil Filter.....	H-5503	769 (CONSTRUCTION & MINING) S/N: 99F1230-UP	
Hydraulic Oil Filter.....	H-55270	Hydraulic Oil Filter.....	HC-5504	Hydraulic Oil Filter.....	H-5503
Hydraulic Oil Filter.....	HC-5507	Hydraulic Oil Filter.....	HC-5504	769 (CONSTRUCTION & MINING) S/N: 99F1231-1237	
		Hydraulic Oil Filter.....	HC-5504	Hydraulic Oil Filter.....	H-55280



ENGINE APPLICATION

MODEL/APPLICATION	SAKURA NO	MODEL/APPLICATION	SAKURA NO	MODEL/APPLICATION	SAKURA NO
CATERPILLAR		CATERPILLAR		CATERPILLAR	
769 (CONSTRUCTION & MINING) S/N: 99F1231-1237		Hydraulic Oil Filter.....	HC-5504	773B (CONSTRUCTION & MINING) CAT 3412 (S/N: 63W1-UP) , 2005-UP	
Hydraulic Oil Filter.....	H-5503	Hydraulic Oil Filter.....	HC-5505	Hydraulic Oil Filter.....	H-5503
769 (CONSTRUCTION & MINING) S/N: 99F1238-UP		Hydraulic Oil Filter.....	HC-5516	773B (CONSTRUCTION & MINING) S/N: 63W1-UP	
Hydraulic Oil Filter.....	H-55280	Hydraulic Oil Filter.....	HC-5511	Hydraulic Oil Filter.....	H-5503
Hydraulic Oil Filter.....	H-5503	771D (CONSTRUCTION & MINING) CAT 3408E TA-HEUI (S/N: 6YS1-UP)		773D (CONSTRUCTION & MINING) CAT 3412E (S/N: 7CS1-UP) , 2005-UP	
769B (CONSTRUCTION & MINING) S/N: 99F1230-UP		Hydraulic Oil Filter.....	HC-5516	Hydraulic Oil Filter.....	H-5503
Hydraulic Oil Filter.....	H-5503	Hydraulic Oil Filter.....	HC-5505	773D (CONSTRUCTION & MINING) CAT 3412E (S/N: 7CS1-UP) , 2005-UP	
769B (DUMP TRUCKS) S/N: 99F1-1229		Hydraulic Oil Filter.....	HC-55300	Hydraulic Oil Filter.....	HC-5516
Hydraulic Oil Filter.....	H-5503	Hydraulic Oil Filter.....	HC-55170	Hydraulic Oil Filter.....	HC-5511
769C (CONSTRUCTION & MINING) CAT 3408 (S/N: 01X02877-05473) , 2005-UP		Hydraulic Oil Filter.....	HC-5504	Hydraulic Oil Filter.....	HC-5504
Hydraulic Oil Filter.....	H-5504	771C (CONSTRUCTION & MINING) S/N: 3BJ200-UP		Hydraulic Oil Filter.....	HC-5505
Hydraulic Oil Filter.....	H-5503	Hydraulic Oil Filter.....	H-55280	773D (CONSTRUCTION & MINING) CAT 3412E (S/N: 7ER1-UP) , 2005-UP	
769C (CONSTRUCTION & MINING) CAT 3408 (S/N: 01X05474-06324) , 2005-UP		Hydraulic Oil Filter.....	H-5503	Hydraulic Oil Filter.....	H-5503
Hydraulic Oil Filter.....	H-5504	Hydraulic Oil Filter.....	H-5526	Hydraulic Oil Filter.....	H-5503
Hydraulic Oil Filter.....	H-5503	Hydraulic Oil Filter.....	H-5504	773D (CONSTRUCTION & MINING) S/N: 7ER1-UP	
769C (CONSTRUCTION & MINING) CAT 3408 (S/N: 01X06325-06599) , 2005-UP		Hydraulic Oil Filter.....	H-55270	Hydraulic Oil Filter.....	H-5526
Hydraulic Oil Filter.....	H-5503	771D US (CONSTRUCTION & MINING) CAT 3408E (S/N: 6JR1-UP)		Hydraulic Oil Filter.....	H-5503
Hydraulic Oil Filter.....	H-5504	Hydraulic Oil Filter.....	H-5504	Hydraulic Oil Filter.....	H-55280
769C (CONSTRUCTION & MINING) CAT 3408 (S/N: 01X1-02876) , 2005-UP		Hydraulic Oil Filter.....	H-5503	773E (CONSTRUCTION & MINING) CAT 3412E (S/N: BDA1-UP) , 2005-UP	
Hydraulic Oil Filter.....	H-5503	772 (DUMP TRUCKS) CAT S/N: RHX1-UP		Hydraulic Oil Filter.....	HC-55170
Hydraulic Oil Filter.....	H-5504	Hydraulic Oil Filter.....	HC-5505	Hydraulic Oil Filter.....	HC-5516
769C (CONSTRUCTION & MINING)		Hydraulic Oil Filter.....	H-5001	Hydraulic Oil Filter.....	HC-55300
Hydraulic Oil Filter.....	H-5504	Hydraulic Oil Filter.....	H-55270	Hydraulic Oil Filter.....	HC-5504
Hydraulic Oil Filter.....	H-5503	Hydraulic Oil Filter.....	HC-5516	Hydraulic Oil Filter.....	HC-5505
769C (CONSTRUCTION & MINING) S/N: 1X6325-UP		Hydraulic Oil Filter.....	HC-55170	Hydraulic Oil Filter.....	HC-5504
Hydraulic Oil Filter.....	H-5503	Hydraulic Oil Filter.....	HC-55300	Hydraulic Oil Filter.....	HC-5511
769D US (CONSTRUCTION & MINING) CAT 3408E (S/N: 5TR1-UP) , 2005-UP		772 (DUMP TRUCKS) CAT S/N: RLB1-UP		773E (CONSTRUCTION & MINING) CAT 3412E (S/N: BDA259-478) , 2005-UP	
Hydraulic Oil Filter.....	H-5503	Hydraulic Oil Filter.....	HC-5505	Hydraulic Oil Filter.....	HC-5516
Hydraulic Oil Filter.....	H-5504	Hydraulic Oil Filter.....	H-55270	Hydraulic Oil Filter.....	HC-55300
771D (CONSTRUCTION & MINING) CAT 3408E (S/N: 6JR1-UP) , 2005-UP		Hydraulic Oil Filter.....	HC-55300	Hydraulic Oil Filter.....	HC-55170
Hydraulic Oil Filter.....	H-5504	Hydraulic Oil Filter.....	H-5001	Hydraulic Oil Filter.....	HC-5505
Hydraulic Oil Filter.....	H-5503	Hydraulic Oil Filter.....	HC-5516	Hydraulic Oil Filter.....	HC-5504
771D (CONSTRUCTION & MINING) CAT 3408E (S/N: 6YS1-UP) , 2005-UP		Hydraulic Oil Filter.....	HC-55170	Hydraulic Oil Filter.....	HC-5511
Hydraulic Oil Filter.....	HC-5516	772 (DUMP TRUCKS)		773E (CONSTRUCTION & MINING) CAT S/N: 5JJ264-UP , 2005-UP	
Hydraulic Oil Filter.....	HC-5504	Hydraulic Oil Filter.....	H-5503	Hydraulic Oil Filter.....	HC-55300
Hydraulic Oil Filter.....	HC-5511	Hydraulic Oil Filter.....	H-5503	Hydraulic Oil Filter.....	HC-5511
Hydraulic Oil Filter.....	HC-5505	773 (CONSTRUCTION & MINING) S/N: 63G1-252		Hydraulic Oil Filter.....	HC-55290
771D (CONSTRUCTION & MINING) CAT 3408E (S/N: BCA1-UP)		Hydraulic Oil Filter.....	H-5503	Hydraulic Oil Filter.....	HC-5504
Hydraulic Oil Filter.....	HC-5505	773 (CONSTRUCTION & MINING) S/N: 63G253-339		Hydraulic Oil Filter.....	HC-5505
771D (CONSTRUCTION & MINING) CAT 3408E (S/N: 6YS1-UP) , 2005-UP		Hydraulic Oil Filter.....	H-5503	Hydraulic Oil Filter.....	HC-5516
Hydraulic Oil Filter.....	HC-5516	773 (CONSTRUCTION & MINING) S/N: 63G340-858		773E (CONSTRUCTION & MINING) CAT S/N: BDA1-159-UP , 2005-UP	
Hydraulic Oil Filter.....	HC-5504	Hydraulic Oil Filter.....	H-5503	Hydraulic Oil Filter.....	HC-5504
Hydraulic Oil Filter.....	HC-5511	773 (CONSTRUCTION & MINING) S/N: 63G859-UP		Hydraulic Oil Filter.....	HC-5516
Hydraulic Oil Filter.....	HC-5505	Hydraulic Oil Filter.....	H-5503	Hydraulic Oil Filter.....	HC-55300
771D (CONSTRUCTION & MINING) CAT 3408E (S/N: BCA1-UP)		773 (CONSTRUCTION & MINING) S/N: 63G859-UP		Hydraulic Oil Filter.....	HC-5505
Hydraulic Oil Filter.....	HC-5505	Hydraulic Oil Filter.....	H-5503	Hydraulic Oil Filter.....	HC-55290
771D (CONSTRUCTION & MINING) CAT 3408E (S/N: BCA1-UP)		Hydraulic Oil Filter.....	H-5503	Hydraulic Oil Filter.....	HC-55170
Hydraulic Oil Filter.....	HC-5505	773 (CONSTRUCTION & MINING) S/N: 63G859-UP		Hydraulic Oil Filter.....	HC-5511
Hydraulic Oil Filter.....	HC-5505	Hydraulic Oil Filter.....	H-5503		



ENGINE APPLICATION

MODEL/APPLICATION	SAKURA NO	MODEL/APPLICATION	SAKURA NO	MODEL/APPLICATION	SAKURA NO
CATERPILLAR		CATERPILLAR		CATERPILLAR	
773E (CONSTRUCTION & MINING) CAT S/N: BDA160-UP , 2005-UP		775F (CONSTRUCTION & MINING) CAT S/N: LJX1-UP , 2006-UP		Hydraulic Oil Filter.....	HC-5511
Hydraulic Oil Filter.....	HC-5516	Hydraulic Oil Filter.....	HC-5505	Hydraulic Oil Filter.....	H-55270
Hydraulic Oil Filter.....	HC-5504	Hydraulic Oil Filter.....	HC-55170	776C (DUMPERS) CAT S/N: 2TK1-UP	
Hydraulic Oil Filter.....	HC-5511	Hydraulic Oil Filter.....	H-5001	Hydraulic Oil Filter.....	H-5503
Hydraulic Oil Filter.....	HC-55300	775B US (CONSTRUCTION & MINING) CAT 3412 DITA (S/N: 7XJ200-UP) , 2005-UP		Hydraulic Oil Filter.....	H-55270
Hydraulic Oil Filter.....	HC-55170	Hydraulic Oil Filter.....	H-5503	776C (DUMPERS) CAT S/N: 7YG1-211-UP	
Hydraulic Oil Filter.....	HC-5505	775D US (CONSTRUCTION & MINING) CAT 3412 DITA (S/N: 6KR124-UP) , 2005-UP		Hydraulic Oil Filter.....	H-5503
Hydraulic Oil Filter.....	HC-55290	Hydraulic Oil Filter.....	H-5503	Hydraulic Oil Filter.....	H-55270
773F (CONSTRUCTION & MINING) 2007-UP		776 (CRAWLERS) S/N: 14H1-UP		776C (DUMPERS) CAT S/N: 7YG212-UP	
Hydraulic Oil Filter.....	H-5504	Hydraulic Oil Filter.....	H-5503	Hydraulic Oil Filter.....	H-55270
773D US (CONSTRUCTION & MINING) CAT 3412E (S/N: 7ER1-UP) , 2005-UP		776 (SCRAPERS) w/D348 Eng.		Hydraulic Oil Filter.....	H-5503
Hydraulic Oil Filter.....	H-5503	Hydraulic Oil Filter.....	H-55320	776D US (CONSTRUCTION & MINING) CAT 3508B (S/N: 5ER1-UP)	
775 (CONSTRUCTION & MINING)		776B (CONSTRUCTION & MINING) S/N: 6JC1-UP		Hydraulic Oil Filter.....	H-5503
Hydraulic Oil Filter.....	H-5517	Hydraulic Oil Filter.....	H-5503	777 (CONSTRUCTION & MINING) S/N: 84A1-UP	
Hydraulic Oil Filter.....	H-5503	776D (CONSTRUCTION & MINING)		Hydraulic Oil Filter.....	H-5503
775B (CONSTRUCTION & MINING) CAT 3412 (S/N: 7XJ200-UP) , 2005-UP		Hydraulic Oil Filter.....	H-5504	777 (DUMP TRUCKS) S/N: 84A1-559-UP	
Hydraulic Oil Filter.....	H-5503	776D (DUMP TRUCKS) S/N: 5ER1-122-UP		Hydraulic Oil Filter.....	H-55270
775B (CONSTRUCTION & MINING) S/N: 7XJ200-UP		Hydraulic Oil Filter.....	H-5503	Hydraulic Oil Filter.....	H-5503
Hydraulic Oil Filter.....	H-5503	Hydraulic Oil Filter.....	H-5526	777A (CONSTRUCTION & MINING) CAT D348	
Hydraulic Oil Filter.....	H-55280	Hydraulic Oil Filter.....	H-55280	Hydraulic Oil Filter.....	H-5503
Hydraulic Oil Filter.....	H-5526	Hydraulic Oil Filter.....	H-55270	777B (CONSTRUCTION & MINING) CAT 3508 (S/N: 4YC1-UP) , 2005-UP	
775D (CONSTRUCTION & MINING) CAT 3412E (S/N: 6KR1-123) , 2005-UP		776D (DUMP TRUCKS) S/N: 5ER123-UP		Hydraulic Oil Filter.....	H-5503
Hydraulic Oil Filter.....	H-5503	Hydraulic Oil Filter.....	H-5503	Hydraulic Oil Filter.....	H-5504
775D (CONSTRUCTION & MINING) CAT 3412E (S/N: 8A51-UP) , 2005-UP		Hydraulic Oil Filter.....	H-5526	777B (CONSTRUCTION & MINING) S/N: 4YC1-UP	
Hydraulic Oil Filter.....	HC-5511	Hydraulic Oil Filter.....	H-5526	Hydraulic Oil Filter.....	H-5503
Hydraulic Oil Filter.....	HC-5516	Hydraulic Oil Filter.....	H-55280	777C (CONSTRUCTION & MINING) S/N: 4XJ1-UP	
Hydraulic Oil Filter.....	HC-5505	Hydraulic Oil Filter.....	H-55270	Hydraulic Oil Filter.....	H-5503
Hydraulic Oil Filter.....	HC-5504	776D (DUMP TRUCKS) S/N: AFS1-80-UP		777D (CONSTRUCTION & MINING) CAT 3512B (S/N: 3PR1-UP) , 2005-UP	
775D (CONSTRUCTION & MINING) S/N: 6KR1-123		Hydraulic Oil Filter.....	HC-5505	Hydraulic Oil Filter.....	H-5503
Hydraulic Oil Filter.....	H-5526	Hydraulic Oil Filter.....	H-5526	777D (CONSTRUCTION & MINING) CAT 3512B (S/N: AGC1-UP) , 2005-UP	
Hydraulic Oil Filter.....	H-5503	Hydraulic Oil Filter.....	HC-55170	Hydraulic Oil Filter.....	H-5503
Hydraulic Oil Filter.....	H-55280	Hydraulic Oil Filter.....	HC-55290	Hydraulic Oil Filter.....	H-55270
775E (CONSTRUCTION & MINING) CAT 3412E (S/N: BEC1-UP) , 2005-UP		Hydraulic Oil Filter.....	H-5503	Hydraulic Oil Filter.....	H-5504
Hydraulic Oil Filter.....	HC-5505	Hydraulic Oil Filter.....	H-55280	777D (CONSTRUCTION & MINING) CAT 3512B (S/N: AGY1-UP) , 2005-UP	
Hydraulic Oil Filter.....	HC-5504	Hydraulic Oil Filter.....	HC-5511	Hydraulic Oil Filter.....	HC-5511
Hydraulic Oil Filter.....	HC-5511	Hydraulic Oil Filter.....	H-55270	Hydraulic Oil Filter.....	H-5503
Hydraulic Oil Filter.....	HC-5516	Hydraulic Oil Filter.....	H-55280	Hydraulic Oil Filter.....	H-5505
775F (CONSTRUCTION & MINING) CAT S/N: DLS1-UP , 2006-UP		Hydraulic Oil Filter.....	H-55270	Hydraulic Oil Filter.....	H-5504
Hydraulic Oil Filter.....	H-5001	776D (DUMP TRUCKS) S/N: AFS81-UP		777D (CONSTRUCTION & MINING) CAT 3512B (S/N: AGY1-UP) , 2005-UP	
Hydraulic Oil Filter.....	HC-5505	Hydraulic Oil Filter.....	H-5503	Hydraulic Oil Filter.....	HC-5505
Hydraulic Oil Filter.....	HC-55170	Hydraulic Oil Filter.....	HC-55170	Hydraulic Oil Filter.....	HC-5511
775F (CONSTRUCTION & MINING) CAT S/N: DLS1-UP , 2006-UP		Hydraulic Oil Filter.....	H-55280	777D (CONSTRUCTION & MINING) CAT 3512B (S/N: AGY1-UP) , 2005-UP	
Hydraulic Oil Filter.....	H-5001	Hydraulic Oil Filter.....	HC-55290	Hydraulic Oil Filter.....	HC-5505
Hydraulic Oil Filter.....	HC-5505	Hydraulic Oil Filter.....	H-5526	Hydraulic Oil Filter.....	HC-5511
Hydraulic Oil Filter.....	HC-55170	Hydraulic Oil Filter.....	HC-5505		



ENGINE APPLICATION

MODEL/APPLICATION	SAKURA NO
CATERPILLAR	
777D (CONSTRUCTION & MINING) CAT 3512B (S/N: AGY1-UP) , 2005-UP	
Hydraulic Oil Filter.....	H-5503
Hydraulic Oil Filter.....	H-5504
777D (CONSTRUCTION & MINING) CAT 3508B EUI (S/N: 3PR1-UP)	
Hydraulic Oil Filter.....	H-55280
Hydraulic Oil Filter.....	H-5503
Hydraulic Oil Filter.....	H-5526
Hydraulic Oil Filter.....	H-5504
Hydraulic Oil Filter.....	H-55270
777D (CONSTRUCTION & MINING) CAT 3508B EUI (S/N: AGC1-UP)	
Hydraulic Oil Filter.....	H-5503
Hydraulic Oil Filter.....	HC-55170
Hydraulic Oil Filter.....	HC-5511
Hydraulic Oil Filter.....	H-5526
Hydraulic Oil Filter.....	H-5504
Hydraulic Oil Filter.....	HC-5505
Hydraulic Oil Filter.....	H-55270
Hydraulic Oil Filter.....	H-55280
777D (CONSTRUCTION & MINING) CAT 3508B EUI (S/N: AGY1-UP)	
Hydraulic Oil Filter.....	H-5503
Hydraulic Oil Filter.....	HC-55170
Hydraulic Oil Filter.....	HC-5511
Hydraulic Oil Filter.....	H-55280
Hydraulic Oil Filter.....	H-55270
Hydraulic Oil Filter.....	H-5526
Hydraulic Oil Filter.....	H-5504
Hydraulic Oil Filter.....	HC-5505
777D HAA (CONSTRUCTION & MINING) S/N: 2YW1-UP	
Hydraulic Oil Filter.....	H-5526
Hydraulic Oil Filter.....	H-5503
Hydraulic Oil Filter.....	H-55280
Hydraulic Oil Filter.....	H-55270
Hydraulic Oil Filter.....	H-5504
777F (CONSTRUCTION & MINING) CAT S/N: JRP1-UP , 2007-UP	
Hydraulic Oil Filter.....	H-55280
Hydraulic Oil Filter.....	HC-55170
Hydraulic Oil Filter.....	H-5526
Hydraulic Oil Filter.....	HC-5505
Hydraulic Oil Filter.....	H-5001
Hydraulic Oil Filter.....	H-5503
777F (CONSTRUCTION & MINING) CAT S/N: LJW2110-UP , 2007-UP	
Hydraulic Oil Filter.....	H-55280
Hydraulic Oil Filter.....	HC-55170
Hydraulic Oil Filter.....	H-5503
Hydraulic Oil Filter.....	H-5526
Hydraulic Oil Filter.....	H-5001
Hydraulic Oil Filter.....	HC-5505

MODEL/APPLICATION	SAKURA NO
CATERPILLAR	
777D US (CONSTRUCTION & MINING) CAT 3508B (S/N: 3PR1-UP) , 2005-UP	
Hydraulic Oil Filter.....	H-5503
Hydraulic Oil Filter.....	H-5504
779 (CONSTRUCTION & MINING)	
Hydraulic Oil Filter.....	H-5503
783B (CONSTRUCTION & MINING) CAT 3512 (S/N: 5YM-UP)	
Hydraulic Oil Filter.....	H-5504
Hydraulic Oil Filter.....	H-5503
Hydraulic Oil Filter.....	H-55270
784B (CONSTRUCTION & MINING) S/N: 1HW-UP	
Hydraulic Oil Filter.....	H-55270
Hydraulic Oil Filter.....	H-5504
Hydraulic Oil Filter.....	H-5503
784B (CONSTRUCTION & MINING) S/N: 6HK-UP	
Hydraulic Oil Filter.....	H-5503
Hydraulic Oil Filter.....	H-55270
Hydraulic Oil Filter.....	H-5504
784B (CONSTRUCTION & MINING) S/N: 8GB-UP	
Hydraulic Oil Filter.....	H-55270
Hydraulic Oil Filter.....	H-5504
Hydraulic Oil Filter.....	H-5503
784B (DUMPERS) S/N: 5RK1-UP	
Hydraulic Oil Filter.....	H-5503
Hydraulic Oil Filter.....	H-5504
784C (CONSTRUCTION & MINING) S/N: 2PZ1-UP	
Hydraulic Oil Filter.....	H-5504
Hydraulic Oil Filter.....	H-55270
Hydraulic Oil Filter.....	H-5503
Hydraulic Oil Filter.....	H-5526
Hydraulic Oil Filter.....	H-55280
785 (CONSTRUCTION & MINING) CAT 3512 (S/N: 8GB1-UP)	
Hydraulic Oil Filter.....	H-55270
Hydraulic Oil Filter.....	H-5504
Hydraulic Oil Filter.....	H-5503
785B (CONSTRUCTION & MINING) CAT 3512 (S/N: 6HK1-UP)	
Hydraulic Oil Filter.....	H-55270
Hydraulic Oil Filter.....	H-5504
Hydraulic Oil Filter.....	H-5503
785B (CONSTRUCTION & MINING) CAT 3512 TA-EUI (S/N: 6HK433-UP)	
Hydraulic Oil Filter.....	H-5504
Hydraulic Oil Filter.....	H-5503
Hydraulic Oil Filter.....	H-55270

MODEL/APPLICATION	SAKURA NO
CATERPILLAR	
Hydraulic Oil Filter.....	H-55280
Hydraulic Oil Filter.....	H-5526
785B (CONSTRUCTION & MINING) S/N: 1HW-UP	
Hydraulic Oil Filter.....	H-55270
Hydraulic Oil Filter.....	H-5504
Hydraulic Oil Filter.....	H-5503
785B (CONSTRUCTION & MINING) S/N: 6HK00123-6HK00129	
Hydraulic Oil Filter.....	H-5504
Hydraulic Oil Filter.....	H-55270
Hydraulic Oil Filter.....	H-5503
785B (CONSTRUCTION & MINING) S/N: 6HK00216-6HK00216	
Hydraulic Oil Filter.....	H-5503
Hydraulic Oil Filter.....	H-5504
Hydraulic Oil Filter.....	H-55270
785B (CONSTRUCTION & MINING) S/N: 6HK-UP	
Hydraulic Oil Filter.....	H-5504
Hydraulic Oil Filter.....	H-55270
Hydraulic Oil Filter.....	H-5503
785B (CONSTRUCTION & MINING) S/N: 8GB-UP	
Hydraulic Oil Filter.....	H-5504
Hydraulic Oil Filter.....	H-55270
Hydraulic Oil Filter.....	H-5503
785C (CONSTRUCTION & MINING) CAT 3516B (S/N: 1HW1-UP) , 2005-UP	
Hydraulic Oil Filter.....	H-5503
Hydraulic Oil Filter.....	H-5504
Hydraulic Oil Filter.....	H-5526
785C (CONSTRUCTION & MINING) CAT 3516B (S/N: SAZ1-UP) , 2005-UP	
Hydraulic Oil Filter.....	H-5503
Hydraulic Oil Filter.....	H-5504
785C (CONSTRUCTION & MINING) CAT 3516B (S/N: APX1-UP) , 2005-UP	
Hydraulic Oil Filter.....	H-5504
Hydraulic Oil Filter.....	H-5503
785C (CONSTRUCTION & MINING) CAT 3512 TA-EUI (S/N: 1HW1-UP)	
Hydraulic Oil Filter.....	H-5503
Hydraulic Oil Filter.....	H-5504
Hydraulic Oil Filter.....	H-55270
Hydraulic Oil Filter.....	H-55280
785C (CONSTRUCTION & MINING) CAT 3512 TA-EUI (S/N: 5AZ1-UP)	
Hydraulic Oil Filter.....	H-5503
Hydraulic Oil Filter.....	H-5504
Hydraulic Oil Filter.....	H-55280
Hydraulic Oil Filter.....	H-55270
Hydraulic Oil Filter.....	H-5526



ENGINE APPLICATION

MODEL/APPLICATION	SAKURA NO	MODEL/APPLICATION	SAKURA NO	MODEL/APPLICATION	SAKURA NO
CATERPILLAR		CATERPILLAR		CATERPILLAR	
787B (CONSTRUCTION & MINING) CAT S/N: 2PK450-UP Hydraulic Oil Filter..... H-5503 Hydraulic Oil Filter..... H-55280 Hydraulic Oil Filter..... H-5526 Hydraulic Oil Filter..... H-5506 Hydraulic Oil Filter..... H-55270		793 (CONSTRUCTION & MINING) CAT 3516 (S/N: 35J1-UP) Hydraulic Oil Filter..... H-55280 Hydraulic Oil Filter..... H-5503 Hydraulic Oil Filter..... H-5506 Hydraulic Oil Filter..... H-5504 793 (CONSTRUCTION & MINING) S/N: 35J6-UP Hydraulic Oil Filter..... H-5506 Hydraulic Oil Filter..... H-5504 793B (CONSTRUCTION & MINING) CAT 3516 (S/N: 1HL1-UP) Hydraulic Oil Filter..... HC-5503 Hydraulic Oil Filter..... H-5503 Hydraulic Oil Filter..... H-5504 Hydraulic Oil Filter..... H-55280 Hydraulic Oil Filter..... H-5506 Hydraulic Oil Filter..... HC-5506 793B (CONSTRUCTION & MINING) CAT 3516 (S/N: 2HL-UP) Hydraulic Oil Filter..... H-5503 Hydraulic Oil Filter..... H-5504 793C (CONSTRUCTION & MINING) CAT 3516 (S/N: 4AR1-UP) , 2005-UP Hydraulic Oil Filter..... H-5503 Hydraulic Oil Filter..... HC-5506 Hydraulic Oil Filter..... HC-5503 Hydraulic Oil Filter..... H-5506 Hydraulic Oil Filter..... H-5526 Hydraulic Oil Filter..... H-5504 Hydraulic Oil Filter..... HC-5503 Hydraulic Oil Filter..... H-5506 793C (CONSTRUCTION & MINING) CAT 3516 (S/N: 4GZ1-UP) , 2005-UP Hydraulic Oil Filter..... H-5526 Hydraulic Oil Filter..... H-5503 Hydraulic Oil Filter..... HC-5506 Hydraulic Oil Filter..... H-5504 Hydraulic Oil Filter..... HC-5503 Hydraulic Oil Filter..... H-5506 793C (CONSTRUCTION & MINING) CAT 3516 (S/N: 4AT1-UP) , 2005-UP Hydraulic Oil Filter..... H-5503 Hydraulic Oil Filter..... H-5504 Hydraulic Oil Filter..... HC-5506 Hydraulic Oil Filter..... H-55270 Hydraulic Oil Filter..... H-5506 793C (CONSTRUCTION & MINING) CAT 3516B EUI (S/N: 4AR1-UP) Hydraulic Oil Filter..... H-5526 Hydraulic Oil Filter..... H-55270 Hydraulic Oil Filter..... H-55280 Hydraulic Oil Filter..... H-5504 Hydraulic Oil Filter..... H-5503 Hydraulic Oil Filter..... HC-5506 Hydraulic Oil Filter..... H-5506 793C (CONSTRUCTION & MINING) CAT 3516B EUI (S/N: 4AT1-UP) Hydraulic Oil Filter..... H-5526 Hydraulic Oil Filter..... H-55280 Hydraulic Oil Filter..... H-55280 Hydraulic Oil Filter..... H-5503 Hydraulic Oil Filter..... H-5506 Hydraulic Oil Filter..... H-5504 Hydraulic Oil Filter..... HC-5512 Hydraulic Oil Filter..... H-55270 Hydraulic Oil Filter..... H-5503 Hydraulic Oil Filter..... H-5504 Hydraulic Oil Filter..... H-5526 Hydraulic Oil Filter..... HC-5506		793C (CONSTRUCTION & MINING) CAT 3516B EUI (S/N: 4GZ1-UP) Hydraulic Oil Filter..... H-5506 Hydraulic Oil Filter..... H-55280 Hydraulic Oil Filter..... HC-5512 Hydraulic Oil Filter..... H-55270 Hydraulic Oil Filter..... H-5503 Hydraulic Oil Filter..... H-5504 Hydraulic Oil Filter..... H-5526 Hydraulic Oil Filter..... HC-5506 793C (CONSTRUCTION & MINING) CAT 3516B EUI (S/N: 4TY1-UP) Hydraulic Oil Filter..... HC-5506 Hydraulic Oil Filter..... H-5504 Hydraulic Oil Filter..... H-55270 Hydraulic Oil Filter..... HC-5512 Hydraulic Oil Filter..... H-5506 793D (CONSTRUCTION & MINING) CAT S/N: 7TR1-UP Hydraulic Oil Filter..... H-55280 Hydraulic Oil Filter..... H-55270 Hydraulic Oil Filter..... H-5526 Hydraulic Oil Filter..... H-5503 793D (CONSTRUCTION & MINING) CAT S/N: 8WM1-UP Hydraulic Oil Filter..... H-5503 Hydraulic Oil Filter..... H-5526 Hydraulic Oil Filter..... H-55280 Hydraulic Oil Filter..... H-55270 793D (CONSTRUCTION & MINING) CAT S/N: FDB1-UP Hydraulic Oil Filter..... H-5526 Hydraulic Oil Filter..... H-5503 Hydraulic Oil Filter..... H-55270 Hydraulic Oil Filter..... H-55280 797 (CONSTRUCTION & MINING) CAT 3524B (S/N: 5YW1-UP) , 2005-UP Hydraulic Oil Filter..... H-5503 Hydraulic Oil Filter..... H-5504 Hydraulic Oil Filter..... H-5001 Hydraulic Oil Filter..... HC-5511 797 (CONSTRUCTION & MINING) S/N: 5YW1-UP Hydraulic Oil Filter..... H-5503 Hydraulic Oil Filter..... H-5504 Hydraulic Oil Filter..... HC-5511 Hydraulic Oil Filter..... H-55270 Hydraulic Oil Filter..... H-5001 797B (CONSTRUCTION & MINING) CAT 3524B EUI (S/N: 3SM1-UP) , 2004-UP Hydraulic Oil Filter..... H-5503 Hydraulic Oil Filter..... H-5001 Hydraulic Oil Filter..... HC-5511	
789 (CONSTRUCTION & MINING) CAT 3516 (S/N: 2BW-UP) Hydraulic Oil Filter..... H-5504 Hydraulic Oil Filter..... H-5506 Hydraulic Oil Filter..... H-5503 789 (CONSTRUCTION & MINING) CAT 3516 (S/N: 7EK-UP) Hydraulic Oil Filter..... H-5504 Hydraulic Oil Filter..... H-5506 Hydraulic Oil Filter..... H-5503 789 (CONSTRUCTION & MINING) CAT 3516 (S/N: 9ZC1-UP) Hydraulic Oil Filter..... H-5504 Hydraulic Oil Filter..... H-5503 Hydraulic Oil Filter..... H-55270 Hydraulic Oil Filter..... H-5506 789 (CONSTRUCTION & MINING) CAT 3516 (S/N: 9ZC-UP) Hydraulic Oil Filter..... H-5506 Hydraulic Oil Filter..... H-5504 Hydraulic Oil Filter..... H-5503 789B (CONSTRUCTION & MINING) CAT 3516 (S/N: 7EK1-UP) Hydraulic Oil Filter..... H-5504 Hydraulic Oil Filter..... H-5503 Hydraulic Oil Filter..... H-5506 Hydraulic Oil Filter..... H-55270 789C (CONSTRUCTION & MINING) CAT 3516 (S/N: 2BW1-UP) , 2005-UP Hydraulic Oil Filter..... H-5506 Hydraulic Oil Filter..... H-5503 Hydraulic Oil Filter..... H-5504 789C (CONSTRUCTION & MINING) CAT 3516TA EUI (S/N: 2BW1-UP) Hydraulic Oil Filter..... H-55270 Hydraulic Oil Filter..... H-5504 Hydraulic Oil Filter..... H-5526 Hydraulic Oil Filter..... H-5506 Hydraulic Oil Filter..... H-5503 Hydraulic Oil Filter..... H-55280					



ENGINE APPLICATION

MODEL/APPLICATION	SAKURA NO	MODEL/APPLICATION	SAKURA NO	MODEL/APPLICATION	SAKURA NO
CATERPILLAR		CATERPILLAR		CATERPILLAR	
7WK (EXCAVATORS)		815 (COMPACTORS) S/N: 15R1-UP		816 (COMPACTORS) S/N: 57U1-UP	
Hydraulic Oil Filter.....	HC-5505	Hydraulic Oil Filter.....	H-5504	Hydraulic Oil Filter.....	H-5504
Hydraulic Oil Filter.....	H-5505	Hydraulic Oil Filter.....	H-5503	Hydraulic Oil Filter.....	H-5508
814 (COMPACTORS) S/N: 14R1-UP		815 (COMPACTORS) S/N: 91P1-91P243		816B (COMPACTORS) S/N: 15Z1-UP	
Hydraulic Oil Filter.....	H-5503	Hydraulic Oil Filter.....	H-5503	Hydraulic Oil Filter.....	H-55270
Hydraulic Oil Filter.....	H-5504	Hydraulic Oil Filter.....	H-5504	Hydraulic Oil Filter.....	H-5504
				Hydraulic Oil Filter.....	H-5506
814 (COMPACTORS) S/N: 90P1-156		815 (COMPACTORS) S/N: 91P244-919		816F II (COMPACTORS) CAT S/N: BZR1-UP	
Hydraulic Oil Filter.....	H-5503	Hydraulic Oil Filter.....	H-5504	Hydraulic Oil Filter.....	H-5506
Hydraulic Oil Filter.....	H-5504	Hydraulic Oil Filter.....	H-5503	Hydraulic Oil Filter.....	H-55270
814 (COMPACTORS) S/N: 90P157-UP		815 (COMPACTORS) S/N: 91P920-UP		816F II (COMPACTORS) CAT S/N: THX1-UP	
Hydraulic Oil Filter.....	H-5503	Hydraulic Oil Filter.....	H-5503	Hydraulic Oil Filter.....	H-55270
Hydraulic Oil Filter.....	H-5504	Hydraulic Oil Filter.....	H-5504	Hydraulic Oil Filter.....	H-5506
814B (DOZERS) S/N: 16Z1-274		815 (COMPACTORS) S/N: 91P925-925		824C (COMPACTORS) S/N: 29G1-UP	
Hydraulic Oil Filter.....	H-55270	Hydraulic Oil Filter.....	H-5504	Hydraulic Oil Filter.....	H-5503
Hydraulic Oil Filter.....	H-5506	Hydraulic Oil Filter.....	H-5503		
814B (DOZERS) S/N: 16Z1-UP		815 (COMPACTORS) S/N: EXC. 91P-UP		824C (COMPACTORS) S/N: 36H1-UP	
Hydraulic Oil Filter.....	H-5506	Hydraulic Oil Filter.....	H-5504	Hydraulic Oil Filter.....	H-5503
Hydraulic Oil Filter.....	H-5504	Hydraulic Oil Filter.....	H-5503		
814B (DOZERS) S/N: 16Z275-306		815 (COMPACTORS) w/3306 Eng.		824C (COMPACTORS) S/N: 85X1045-1158	
Hydraulic Oil Filter.....	H-5506	Hydraulic Oil Filter.....	H-55320	Hydraulic Oil Filter.....	H-55270
Hydraulic Oil Filter.....	H-55270				
814B (DOZERS) S/N: 16Z307-UP		815B (COMPACTORS) S/N: 17Z1-UP		824C (COMPACTORS) S/N: 85X1159-1159	
Hydraulic Oil Filter.....	H-5506	Hydraulic Oil Filter.....	H-5504	Hydraulic Oil Filter.....	H-55270
Hydraulic Oil Filter.....	H-55270	Hydraulic Oil Filter.....	H-5506	Hydraulic Oil Filter.....	H-5506
814F (DOZERS) CAT (S/N: 9DM1-UP)		815F (COMPACTORS) CAT 3176C ATAAC (S/N: 1GN1-UP)		824C (COMPACTORS) S/N: 85X1160-1175	
Hydraulic Oil Filter.....	H-5506	Hydraulic Oil Filter.....	H-5504	Hydraulic Oil Filter.....	H-55270
Hydraulic Oil Filter.....	H-55270	Hydraulic Oil Filter.....	H-5506		
814F (DOZERS) CAT (S/N: BGF1-UP)		815F II (COMPACTORS) CAT S/N: BYN1-UP		824C (COMPACTORS) S/N: 85X1176-1193	
Hydraulic Oil Filter.....	H-5506	Hydraulic Oil Filter.....	H-5506	Hydraulic Oil Filter.....	H-55270
Hydraulic Oil Filter.....	H-55270	Hydraulic Oil Filter.....	H-55270	Hydraulic Oil Filter.....	H-5506
814F II (DOZERS) CAT S/N: BXG1-UP		815F II (COMPACTORS) CAT S/N: THX1-UP		824C (COMPACTORS) S/N: 85X1194-1583	
Hydraulic Oil Filter.....	H-55270	Hydraulic Oil Filter.....	H-55270	Hydraulic Oil Filter.....	H-5506
Hydraulic Oil Filter.....	H-5506	Hydraulic Oil Filter.....	H-5506	Hydraulic Oil Filter.....	H-5504
				Hydraulic Oil Filter.....	H-55270
814F II (DOZERS) CAT S/N: THX286-UP		816 (COMPACTORS) S/N: 15U1-UP		824C (COMPACTORS) S/N: 85X1584-UP	
Hydraulic Oil Filter.....	H-55270	Hydraulic Oil Filter.....	H-5508	Hydraulic Oil Filter.....	H-5504
Hydraulic Oil Filter.....	H-5506	Hydraulic Oil Filter.....	H-5504	Hydraulic Oil Filter.....	H-55270
				Hydraulic Oil Filter.....	H-5506
815 (COMPACTORS) S/N: 15R1 EXC. 91P925-UP		816 (COMPACTORS) S/N: 15Z1-UP		824C (COMPACTORS) S/N: 85X1-UP	
Hydraulic Oil Filter.....	H-5504	Hydraulic Oil Filter.....	H-5506		
Hydraulic Oil Filter.....	H-5503	Hydraulic Oil Filter.....	H-5504		



ENGINE APPLICATION

MODEL/APPLICATION	SAKURA NO	MODEL/APPLICATION	SAKURA NO	MODEL/APPLICATION	SAKURA NO
CATERPILLAR		CATERPILLAR		CATERPILLAR	
824C (COMPACTORS) S/N: 85X1-UP Hydraulic Oil Filter..... H-5506 Hydraulic Oil Filter..... H-5504		825C (COMPACTORS) S/N: 86X1-UP Hydraulic Oil Filter..... H-5506 Hydraulic Oil Filter..... H-5504		Hydraulic Oil Filter..... H-5526	
824C (COMPACTORS) S/N: 85X564-836 Hydraulic Oil Filter..... H-55270		825G (COMPACTORS) CAT 3406E ATAAC Hydraulic Oil Filter..... H-5506 Hydraulic Oil Filter..... H-5504		826H (COMPACTORS) S/N: AWF1-UP Hydraulic Oil Filter..... H-5526 Hydraulic Oil Filter..... H-5506 Hydraulic Oil Filter..... H-55280	
824C (COMPACTORS) S/N: 85X837-1044 Hydraulic Oil Filter..... H-55270		825G (COMPACTORS) CAT 3406E ATAAC (S/N: 6RN1-UP) Hydraulic Oil Filter..... H-5504 Hydraulic Oil Filter..... H-5506 Hydraulic Oil Filter..... H-55270		826H (COMPACTORS) S/N: ZXT1-UP Hydraulic Oil Filter..... H-5526 Hydraulic Oil Filter..... H-5506 Hydraulic Oil Filter..... H-55280	
824G II (DOZERS) CAT S/N: AMM1-UP Hydraulic Oil Filter..... H-5506 Hydraulic Oil Filter..... H-5526 Hydraulic Oil Filter..... H-55280		825G II (COMPACTORS) CAT 3406 (S/N: AXB1-437) Hydraulic Oil Filter..... H-5506		82DC (DOZERS) Hydraulic Oil Filter..... H-5506 Hydraulic Oil Filter..... H-5504	
824G II (DOZERS) CAT S/N: BKN1-UP Hydraulic Oil Filter..... H-5506 Hydraulic Oil Filter..... H-5526 Hydraulic Oil Filter..... H-55280		825G II (COMPACTORS) CAT 3406 (S/N: AXB1-UP) Hydraulic Oil Filter..... H-5526		834B (COMPACTORS) CAT 3408 (S/N: 92Z1-UP) Hydraulic Oil Filter..... H-5509 Hydraulic Oil Filter..... H-5504	
824H (DOZERS) CAT S/N: ASX1-299-UP Hydraulic Oil Filter..... H-55280 Hydraulic Oil Filter..... H-5506 Hydraulic Oil Filter..... H-5526		825H (COMPACTORS) CAT S/N: AZW1-299-UP Hydraulic Oil Filter..... H-5526 Hydraulic Oil Filter..... H-5506 Hydraulic Oil Filter..... H-55280		834B (COMPACTORS) CAT 3408E (S/N: 92Z1-UP) Hydraulic Oil Filter..... H-5504 Hydraulic Oil Filter..... H-5509	
824H (DOZERS) CAT S/N: ASX300-UP Hydraulic Oil Filter..... H-5526 Hydraulic Oil Filter..... H-55280		825H (COMPACTORS) CAT S/N: LHX1-UP Hydraulic Oil Filter..... H-5506 Hydraulic Oil Filter..... H-5526 Hydraulic Oil Filter..... H-55280		834B (COMPACTORS) S/N: 7BR1-UP Hydraulic Oil Filter..... H-5509 Hydraulic Oil Filter..... HC-5504 Hydraulic Oil Filter..... H-55270	
824H (DOZERS) CAT S/N: LHX1-UP Hydraulic Oil Filter..... H-55280 Hydraulic Oil Filter..... H-5506 Hydraulic Oil Filter..... H-5526		825H (COMPACTORS) CAT S/N: ZHC1-UP Hydraulic Oil Filter..... H-5506 Hydraulic Oil Filter..... H-5526 Hydraulic Oil Filter..... H-55280		834B (COMPACTORS) S/N: 92Z1-327 Hydraulic Oil Filter..... H-55270	
824H (DOZERS) CAT S/N: ZBD1-UP Hydraulic Oil Filter..... H-5506 Hydraulic Oil Filter..... H-55280 Hydraulic Oil Filter..... H-5526		826 (COMPACTORS) S/N: 58U1-UP Hydraulic Oil Filter..... H-5503		834B (COMPACTORS) S/N: 92Z329-378 Hydraulic Oil Filter..... H-55270	
824G (DOZERS) S/N: 45N1-320 Hydraulic Oil Filter..... H-55270 Hydraulic Oil Filter..... H-5506		826B (COMPACTORS) S/N: 58U1-UP Hydraulic Oil Filter..... H-5503		834B (COMPACTORS) S/N: 92Z379-UP Hydraulic Oil Filter..... H-55270 Hydraulic Oil Filter..... H-5509	
824G (DOZERS) S/N: 45N321-UP Hydraulic Oil Filter..... H-55270 Hydraulic Oil Filter..... H-5506		826C (COMPACTORS) S/N: 87X1-UP Hydraulic Oil Filter..... H-5504 Hydraulic Oil Filter..... H-5506		834G (COMPACTORS) S/N: BPC1-UP Hydraulic Oil Filter..... HC-5512 Hydraulic Oil Filter..... HC-5504	
825 (COMPACTORS) S/N: 43N1-43N493 Hydraulic Oil Filter..... H-5503		826G II (COMPACTORS) CAT S/N: AYH1-UP Hydraulic Oil Filter..... H-5526 Hydraulic Oil Filter..... H-5506 Hydraulic Oil Filter..... H-55280		834H (DOZERS) S/N: BTX1-UP Hydraulic Oil Filter..... HC-5512 Hydraulic Oil Filter..... HC-5504	
825 (COMPACTORS) S/N: 43N494-UP Hydraulic Oil Filter..... H-5503		826G II (COMPACTORS) CAT S/N: BKN1-UP Hydraulic Oil Filter..... H-5506 Hydraulic Oil Filter..... H-55280		834H (DOZERS) S/N: XDC1-UP Hydraulic Oil Filter..... HC-5512	



ENGINE APPLICATION

MODEL/APPLICATION	SAKURA NO	MODEL/APPLICATION	SAKURA NO	MODEL/APPLICATION	SAKURA NO
CATERPILLAR		CATERPILLAR		CATERPILLAR	
834H (DOZERS) S/N: XDC1-UP Hydraulic Oil Filter.....	HC-5504	844 (COMPACTORS) S/N: BBN1-UP Hydraulic Oil Filter.....	H-5506	Hydraulic Oil Filter.....	HC-5506
834 (COMPACTORS) S/N: 43E1-UP Hydraulic Oil Filter.....	H-5503	Hydraulic Oil Filter.....	H-55280	Hydraulic Oil Filter.....	HC-5503
835 (COMPACTORS) S/N: 44N1-298 Hydraulic Oil Filter.....	H-5503	Hydraulic Oil Filter.....	H-5526	Hydraulic Oil Filter.....	HC-5512
835 (COMPACTORS) S/N: 44N299-UP Hydraulic Oil Filter.....	H-5503	844H (DOZERS) CAT S/N: BTW1-UP Hydraulic Oil Filter.....	H-5506	85D (TRACTORS) CAT S/N: 4GR1-UP Hydraulic Oil Filter.....	HC-5512
836 (COMPACTORS) CAT 3408 (S/N: 7FR1-263-UP) Hydraulic Oil Filter.....	H-5509	Hydraulic Oil Filter.....	H-5526	Hydraulic Oil Filter.....	HC-5503
Hydraulic Oil Filter.....	H-5504	Hydraulic Oil Filter.....	HC-5504	Hydraulic Oil Filter.....	HC-5506
836 (COMPACTORS) CAT 3408 (S/N: 7FR1-264-UP) Hydraulic Oil Filter.....	H-5509	Hydraulic Oil Filter.....	H-55280	85D (TRACTORS) CAT S/N: 6AR1-UP Hydraulic Oil Filter.....	HC-5512
Hydraulic Oil Filter.....	H-5509	844H (DOZERS) CAT S/N: EHX1-2415-UP Hydraulic Oil Filter.....	H-5526	Hydraulic Oil Filter.....	HC-5506
836 (COMPACTORS) S/N: 3RL1-UP Hydraulic Oil Filter.....	H-5504	Hydraulic Oil Filter.....	HC-5504	Hydraulic Oil Filter.....	HC-5503
Hydraulic Oil Filter.....	H-5509	Hydraulic Oil Filter.....	H-5506	Hydraulic Oil Filter.....	HC-5506
836G (COMPACTORS) CAT 3456 DITA (S/N: 7MZ1-UP) Hydraulic Oil Filter.....	HC-5506	Hydraulic Oil Filter.....	H-55280	85E (TRACTORS) S/N: 1NM1-UP Hydraulic Oil Filter.....	HC-5512
Hydraulic Oil Filter.....	HC-5503	844H (DOZERS) CAT S/N: EHX2416-2486-UP Hydraulic Oil Filter.....	H-5526	Hydraulic Oil Filter.....	HC-5506
Hydraulic Oil Filter.....	HC-5504	Hydraulic Oil Filter.....	HC-5504	Hydraulic Oil Filter.....	HC-5512
Hydraulic Oil Filter.....	HC-5512	Hydraulic Oil Filter.....	H-5506	Hydraulic Oil Filter.....	HC-5503
836H (COMPACTORS) S/N: BXD1-429-UP Hydraulic Oil Filter.....	HC-5504	Hydraulic Oil Filter.....	H-55280	Hydraulic Oil Filter.....	HC-5506
Hydraulic Oil Filter.....	HC-5512	844H (DOZERS) CAT S/N: EHX2487-UP Hydraulic Oil Filter.....	HC-5504	85E (TRACTORS) S/N: 6JS1-UP Hydraulic Oil Filter.....	HC-5512
836H (COMPACTORS) S/N: BXD430-UP Hydraulic Oil Filter.....	HC-5504	Hydraulic Oil Filter.....	H-5506	Hydraulic Oil Filter.....	HC-5503
Hydraulic Oil Filter.....	HC-5512	854G (DOZERS) S/N: 1JW1-237-UP Hydraulic Oil Filter.....	H-5526	Hydraulic Oil Filter.....	HC-5506
836H (COMPACTORS) S/N: XTR1-UP Hydraulic Oil Filter.....	HC-5504	Hydraulic Oil Filter.....	H-55280	85E (TRACTORS) S/N: 6KS1-UP Hydraulic Oil Filter.....	HC-5506
Hydraulic Oil Filter.....	HC-5512	854G (DOZERS) S/N: 1JW238-UP Hydraulic Oil Filter.....	HC-5504	Hydraulic Oil Filter.....	HC-5503
836C (COMPACTORS) S/N: 7FR1-225 Hydraulic Oil Filter.....	H-5504	Hydraulic Oil Filter.....	H-55280	Hydraulic Oil Filter.....	HC-5512
844 (COMPACTORS) CAT 3412E Hydraulic Oil Filter.....	H-5506	Hydraulic Oil Filter.....	HC-5512	902 (LOADERS) CAT 3024 (S/N: 7ES1-UP) Hydraulic Oil Filter.....	HC-5504
844 (COMPACTORS) S/N: 2KZ1-UP Hydraulic Oil Filter.....	H-5526	Hydraulic Oil Filter.....	H-5526	906 (LOADERS) CAT 3044C (S/N: 6ZS1-UP) Hydraulic Oil Filter.....	HC-5504
Hydraulic Oil Filter.....	H-5506	854G (DOZERS) S/N: A4W1-UP Hydraulic Oil Filter.....	H-55280	Hydraulic Oil Filter.....	HC-5504
844 (COMPACTORS) S/N: 2KZ1-UP Hydraulic Oil Filter.....	H-5526	Hydraulic Oil Filter.....	H-5526	906 (LOADERS) S/N: MER1-UP Hydraulic Oil Filter.....	HC-5504
Hydraulic Oil Filter.....	H-5506	Hydraulic Oil Filter.....	HC-5512	906H (LOADERS) CAT 3044C , 2007-UP Hydraulic Oil Filter.....	HC-5504
85C (TRACTORS) S/N: 9TK1-UP		Hydraulic Oil Filter.....	HC-5504	908 (LOADERS) CAT 3044C (S/N: 8BS1-UP) Hydraulic Oil Filter.....	HC-5504



ENGINE APPLICATION

MODEL/APPLICATION	SAKURA NO	MODEL/APPLICATION	SAKURA NO	MODEL/APPLICATION	SAKURA NO
CATERPILLAR		CATERPILLAR		CATERPILLAR	
910 (LOADERS) S/N: 40Y1-UP Hydraulic Oil Filter.....	H-5504	Hydraulic Oil Filter.....	HC-5504	920 (LOADERS) w/3304 Eng. Hydraulic Oil Filter.....	H-55320
910 (LOADERS) S/N: 41Y1-UP Hydraulic Oil Filter.....	H-5504	914G (LOADERS) S/N: PDF1-UP Hydraulic Oil Filter.....	HC-5504	922A (LOADERS) Hydraulic Oil Filter.....	H-5503
910 (LOADERS) S/N: 45Y22861-33060 Hydraulic Oil Filter.....	H-5504	916 (LOADERS) CAT 3204 (S/N: 2XB1-UP) Hydraulic Oil Filter.....	H-5506	922B (LOADERS) S/N: 59A1-UP Hydraulic Oil Filter.....	H-5503
910 (LOADERS) S/N: 45Y33061-UP Hydraulic Oil Filter.....	H-5504	916 (LOADERS) CAT 3204 (S/N: 5KC1-UP) Hydraulic Oil Filter.....	H-5506	922B (LOADERS) S/N: 88J1-UP Hydraulic Oil Filter.....	H-5503
910 (LOADERS) S/N: 80U1-UP Hydraulic Oil Filter.....	H-5504	916 (LOADERS) CAT 3204 (S/N: 9WB1-UP) Hydraulic Oil Filter.....	H-5506	922B (LOADERS) S/N: 94A1-UP Hydraulic Oil Filter.....	H-5503
910E (LOADERS) S/N: 15F1-1103 Hydraulic Oil Filter.....	H-5510	916 (LOADERS) S/N: 9WB2005-UP Hydraulic Oil Filter.....	H-5506	922C (LOADERS) S/N: 49Z1-UP Hydraulic Oil Filter.....	H-55270
910F (LOADERS) CAT 3114T (S/N: 1KF-UP) Hydraulic Oil Filter.....	H-5504	918F (LOADERS) S/N: 2CK1-UP Hydraulic Oil Filter.....	H-5506	Hydraulic Oil Filter.....	H-5504
910F (LOADERS) CAT 3114T (S/N: 1SF-UP) Hydraulic Oil Filter.....	H-5504	Hydraulic Oil Filter.....	HC-5504	Hydraulic Oil Filter.....	H-5508
910F (LOADERS) S/N: 15F1104-UP Hydraulic Oil Filter.....	HC-5504	918F (LOADERS) S/N: 3TJ1-UP Hydraulic Oil Filter.....	H-5506	Hydraulic Oil Filter.....	H-5509
Hydraulic Oil Filter.....	H-5510	Hydraulic Oil Filter.....	HC-5504	Hydraulic Oil Filter.....	H-55280
910G (LOADERS) S/N: AKR1-UP Hydraulic Oil Filter.....	HC-5504	918F (LOADERS) S/N: 5DL1-UP Hydraulic Oil Filter.....	H-5506	922 (LOADERS) S/N: 63A-UP Hydraulic Oil Filter.....	H-5503
914 (LOADERS) PERKINS Hydraulic Oil Filter.....	HC-5504	Hydraulic Oil Filter.....	HC-5504	924F (LOADERS) S/N: 4YN1463-1533-UP Hydraulic Oil Filter.....	H-5506
914G (LOADERS) S/N: 72M440-653-UP , 2001-2014 Hydraulic Oil Filter.....	HC-5504	920 (LOADERS) S/N: 62K11414-UP Hydraulic Oil Filter.....	H-5504	Hydraulic Oil Filter.....	HC-5504
914G (LOADERS) CAT 3054C DIT (S/N: 7ZM1-UP) Hydraulic Oil Filter.....	HC-5504	920 (LOADERS) S/N: 62K1-3389 Hydraulic Oil Filter.....	H-5504	Hydraulic Oil Filter.....	H-5506
914G (LOADERS) CAT 3054C DIT (S/N: 9WM1-UP) Hydraulic Oil Filter.....	HC-5504	Hydraulic Oil Filter.....	H-5503	924F (LOADERS) S/N: 4YN1534-UP Hydraulic Oil Filter.....	H-5506
914G (LOADERS) S/N: 72M225-439-UP Hydraulic Oil Filter.....	HC-5504	920 (LOADERS) S/N: 62K3390-11413 Hydraulic Oil Filter.....	H-5503	Hydraulic Oil Filter.....	HC-5504
914G (LOADERS) S/N: 72M654-UP Hydraulic Oil Filter.....	HC-5504	Hydraulic Oil Filter.....	H-5504	924F (LOADERS) S/N: 4YN1-UP Hydraulic Oil Filter.....	HC-5504
914G (LOADERS) S/N: 9WM363-1012-UP	HC-5504	920 (LOADERS) S/N: 62K3394 Hydraulic Oil Filter.....	H-5503	Hydraulic Oil Filter.....	H-5506
		Hydraulic Oil Filter.....	H-5504	924F (LOADERS) S/N: 4YN483-1462-UP Hydraulic Oil Filter.....	HC-5504
		920 (LOADERS) S/N: 62K3394-62K3394 Hydraulic Oil Filter.....	H-5503	Hydraulic Oil Filter.....	H-5506
		Hydraulic Oil Filter.....	H-5504	924F (LOADERS) S/N: 5NN1-UP Hydraulic Oil Filter.....	H-5506
		920 (LOADERS) S/N: 75J1-UP Hydraulic Oil Filter.....	H-5504	Hydraulic Oil Filter.....	HC-5504
		Hydraulic Oil Filter.....	H-5503	924F (LOADERS) S/N: 6MN1-457-UP Hydraulic Oil Filter.....	H-5506



ENGINE APPLICATION

MODEL/APPLICATION	SAKURA NO	MODEL/APPLICATION	SAKURA NO	MODEL/APPLICATION	SAKURA NO
CATERPILLAR		CATERPILLAR		CATERPILLAR	
924F (LOADERS) S/N: 6MN1-457-UP Hydraulic Oil Filter.....	HC-5508	924G (LOADERS) S/N: DDA1-UP Hydraulic Oil Filter.....	HC-5504	926 (LOADERS) S/N: 4NB1027-1027-UP Hydraulic Oil Filter.....	H-5501
924F (LOADERS) S/N: 6MN1-UP Hydraulic Oil Filter..... Hydraulic Oil Filter.....	H-5506 HC-5504	924G (LOADERS) S/N: EEB1-UP Hydraulic Oil Filter.....	HC-5504	926 (LOADERS) S/N: 4NB1028-1588-UP Hydraulic Oil Filter.....	H-5501
924F (LOADERS) S/N: 6MN458-UP Hydraulic Oil Filter..... Hydraulic Oil Filter.....	H-5506 HC-5504	924G (LOADERS) S/N: RBB1049-UP Hydraulic Oil Filter.....	HC-5504	926 (LOADERS) S/N: 4NB1-1025-UP Hydraulic Oil Filter.....	H-5501
924F (LOADERS) S/N: 7PN1-UP Hydraulic Oil Filter..... Hydraulic Oil Filter.....	HC-5504 H-5506	924G (LOADERS) S/N: RBB1-832-UP Hydraulic Oil Filter.....	HC-5504	926 (LOADERS) S/N: 4NB1589-1605-UP Hydraulic Oil Filter.....	H-5501
924G (LOADERS) CAT 3056E ATAAC (S/N: 3DZ1-UP) Hydraulic Oil Filter.....	HC-5504	924G (LOADERS) S/N: RBB833-899-UP Hydraulic Oil Filter.....	HC-5504	926 (LOADERS) S/N: 4NB1606-1840-UP Hydraulic Oil Filter.....	H-5501
924G (LOADERS) CAT 3056E ATAAC (S/N: 3PZ1-UP) Hydraulic Oil Filter.....	HC-5504	924G (LOADERS) S/N: RBB900-1048-UP Hydraulic Oil Filter.....	HC-5504	926 (LOADERS) S/N: 4NB1841-3028-UP Hydraulic Oil Filter.....	H-5501
924G (LOADERS) CAT 3056E ATAAC (S/N: 6W1-UP) Hydraulic Oil Filter.....	HC-5504	924G (LOADERS) S/N: WMB1-UP Hydraulic Oil Filter.....	HC-5504	926 (LOADERS) S/N: 4NB3029-UP Hydraulic Oil Filter..... Hydraulic Oil Filter.....	H-5501 H-5506
924G (LOADERS) CAT 3056E ATAAC (S/N: 6YW1-UP) Hydraulic Oil Filter.....	HC-5504	924GZ (LOADERS) CAT 3056 (S/N: DFZ1-UP) Hydraulic Oil Filter.....	HC-5504	926 (LOADERS) S/N: 4NB-UP Hydraulic Oil Filter.....	H-5506
924G (LOADERS) CAT 3056E ATAAC (S/N: 9SW1-UP) Hydraulic Oil Filter.....	HC-5504	924GZ (LOADERS) CAT 3056 (S/N: WGX1-UP) Hydraulic Oil Filter.....	HC-5504	926 (LOADERS) S/N: 8NB1-UP Hydraulic Oil Filter.....	H-5506
924G (LOADERS) CAT 3056E ATAAC (S/N: AAB1-UP) Hydraulic Oil Filter.....	HC-5504	924GZ (LOADERS) CAT 3056E ATAAC (S/N: AAB451-UP) Hydraulic Oil Filter.....	HC-5504	926 (LOADERS) S/N: 94Z1-1716-UP Hydraulic Oil Filter..... Hydraulic Oil Filter.....	H-5506 H-5501
924G (LOADERS) CAT 3056E ATAAC (S/N: AAN1-UP) Hydraulic Oil Filter.....	HC-5504	924GZ (LOADERS) S/N: AAB1-319-UP Hydraulic Oil Filter.....	HC-5504	926 (LOADERS) S/N: 94Z1-2208 Hydraulic Oil Filter.....	H-5506
924G (LOADERS) S/N: 3PZ1-UP Hydraulic Oil Filter.....	HC-5504	924GZ (LOADERS) S/N: AAB320-450-UP Hydraulic Oil Filter.....	HC-5504	926 (LOADERS) S/N: 94Z1717-1820-UP Hydraulic Oil Filter..... Hydraulic Oil Filter.....	H-5506 H-5501
924G (LOADERS) S/N: 9SW1-UP Hydraulic Oil Filter.....	HC-5504	924GZ (LOADERS) S/N: RTA1-390-UP Hydraulic Oil Filter.....	HC-5504	926 (LOADERS) S/N: 94Z1821-2050-UP Hydraulic Oil Filter..... Hydraulic Oil Filter.....	H-5501 H-5506
924G (LOADERS) S/N: AAN1035-UP Hydraulic Oil Filter.....	HC-5504	924GZ (LOADERS) S/N: RTA391-461-UP Hydraulic Oil Filter.....	HC-5504	926 (LOADERS) S/N: 94Z2051-UP Hydraulic Oil Filter..... Hydraulic Oil Filter.....	H-5501 H-5506
924G (LOADERS) S/N: AAN1-674-UP Hydraulic Oil Filter.....	HC-5504	924GZ (LOADERS) S/N: RTA462-496-UP Hydraulic Oil Filter.....	HC-5504	926E (LOADERS) CAT 3204 (S/N: 4NB1-3611-UP) Hydraulic Oil Filter.....	H-5506
924G (LOADERS) S/N: AAN675-1034-UP Hydraulic Oil Filter.....	HC-5504	926 (LOADERS) S/N: 4NB1026-1026-UP Hydraulic Oil Filter.....	H-5501		



ENGINE APPLICATION

MODEL/APPLICATION	SAKURA NO	MODEL/APPLICATION	SAKURA NO	MODEL/APPLICATION	SAKURA NO
CATERPILLAR		CATERPILLAR		CATERPILLAR	
926E (LOADERS) CAT 3204 (S/N: 4NB3612-UP)	H-5506	928F (LOADERS) S/N: 8AK868-UP	H-5506	930 (LOADERS) S/N: 73M1-UP	H-5504
Hydraulic Oil Filter.....		Hydraulic Oil Filter.....		Hydraulic Oil Filter.....	H-5504
926E (LOADERS) CAT 3204 (S/N: 7TC1-UP)	H-5506	928G (LOADERS) CAT 3056E ATAAC (S/N: 6XR1-UP)	HC-5504	Hydraulic Oil Filter.....	H-5503
Hydraulic Oil Filter.....		Hydraulic Oil Filter.....		930 (LOADERS) S/N: 79J1-UP	H-5504
926E (LOADERS) CAT 3204 (S/N: 8NB1-1542-UP)	H-5506	928G (LOADERS) CAT 3056E ATAAC (S/N: 6XR-UP)	HC-5508	Hydraulic Oil Filter.....	H-5503
Hydraulic Oil Filter.....		Hydraulic Oil Filter.....		930G (LOADERS) CAT S/N: CPT1-UP , 2007-UP	HC-5504
926E (LOADERS) CAT 3204 (S/N: 8NB1543-UP)	H-5506	928G (LOADERS) CAT 3056E ATAAC (S/N: 7SR1-UP)	HC-5504	Hydraulic Oil Filter.....	HC-5504
Hydraulic Oil Filter.....		Hydraulic Oil Filter.....		930G (LOADERS) CAT S/N: TFW1-UP , 2007-UP	HC-5504
928F (LOADERS) S/N: 2XL1-578-UP	H-5506	928G (LOADERS) S/N: 6XR1543-UP	HC-5504	Hydraulic Oil Filter.....	HC-5504
Hydraulic Oil Filter.....		Hydraulic Oil Filter.....		930G (LOADERS) CAT S/N: TWR1-786-UP , 2007-UP	HC-5504
Hydraulic Oil Filter.....	HC-5504	928G (LOADERS) S/N: 6XR1-885-UP	HC-5504	Hydraulic Oil Filter.....	HC-5504
928F (LOADERS) S/N: 2XL1757-UP	H-5506	Hydraulic Oil Filter.....		930G (LOADERS) CAT S/N: TWR787-UP , 2007-UP	HC-5504
Hydraulic Oil Filter.....		928G (LOADERS) S/N: 6XR886-1542-UP	HC-5504	Hydraulic Oil Filter.....	HC-5504
928F (LOADERS) S/N: 2XL1-UP	H-5506	Hydraulic Oil Filter.....		930R (LOADERS) S/N: 57Z1275-3999	H-5503
Hydraulic Oil Filter.....		928G (LOADERS) S/N: 7SR1-1380-UP	HC-5504	Hydraulic Oil Filter.....	H-5501
Hydraulic Oil Filter.....	HC-5504	Hydraulic Oil Filter.....		930R (LOADERS) S/N: 57Z1-3016	H-5526
928F (LOADERS) S/N: 2XL579-1756-UP	H-5506	928G (LOADERS) S/N: 7SR1381-UP	HC-5504	Hydraulic Oil Filter.....	H-55280
Hydraulic Oil Filter.....		Hydraulic Oil Filter.....		Hydraulic Oil Filter.....	H-5503
Hydraulic Oil Filter.....	HC-5504	928G (LOADERS) S/N: DJD1-UP	HC-5504	930R (LOADERS) S/N: 57Z1-3999	H-5503
928F (LOADERS) S/N: 7YM1-UP	H-5506	Hydraulic Oil Filter.....		Hydraulic Oil Filter.....	H-5503
Hydraulic Oil Filter.....		928G (LOADERS) S/N: WLG1-UP	HC-5504	930R (LOADERS) S/N: 57Z1-971	H-5501
Hydraulic Oil Filter.....	HC-5508	Hydraulic Oil Filter.....		Hydraulic Oil Filter.....	H-5503
928F (LOADERS) S/N: 8AK11-UP	H-5506	930 (LOADERS) S/N: 17B1-219	H-5503	930R (LOADERS) S/N: 57Z3017-3999	H-55280
Hydraulic Oil Filter.....		Hydraulic Oil Filter.....		Hydraulic Oil Filter.....	H-5503
Hydraulic Oil Filter.....	HC-5508	930 (LOADERS) S/N: 17B220-999	H-5503	Hydraulic Oil Filter.....	H-5526
928F (LOADERS) S/N: 8AK1-494-UP	H-5506	Hydraulic Oil Filter.....		930R (LOADERS) S/N: 57Z4000-4612	H-5503
Hydraulic Oil Filter.....		930 (LOADERS) S/N: 41K1-2326	H-5503	Hydraulic Oil Filter.....	H-5501
Hydraulic Oil Filter.....	HC-5508	Hydraulic Oil Filter.....		930R (LOADERS) S/N: 57Z4613-UP	H-5501
928F (LOADERS) S/N: 8AK1-699	H-5506	Hydraulic Oil Filter.....		Hydraulic Oil Filter.....	H-5503
Hydraulic Oil Filter.....		930 (LOADERS) S/N: 41K2327-5314	H-5503	Hydraulic Oil Filter.....	H-5503
Hydraulic Oil Filter.....	HC-5504	Hydraulic Oil Filter.....		930R (LOADERS) S/N: 57Z972-1274	H-5503
928F (LOADERS) S/N: 8AK495-867-UP	H-5506	Hydraulic Oil Filter.....		Hydraulic Oil Filter.....	H-5503
Hydraulic Oil Filter.....		930 (LOADERS) S/N: 8AK700-UP	H-5503		
Hydraulic Oil Filter.....	HC-5508	Hydraulic Oil Filter.....			
928F (LOADERS) S/N: 8AK700-UP	H-5506	Hydraulic Oil Filter.....			
Hydraulic Oil Filter.....					
Hydraulic Oil Filter.....	HC-5504				
Hydraulic Oil Filter.....	H-5506				



ENGINE APPLICATION

MODEL/APPLICATION	SAKURA NO	MODEL/APPLICATION	SAKURA NO	MODEL/APPLICATION	SAKURA NO
CATERPILLAR		CATERPILLAR		CATERPILLAR	
930R (LOADERS) S/N: 572972-1274 Hydraulic Oil Filter.....	H-5501	Hydraulic Oil Filter.....	H-55320	Hydraulic Oil Filter.....	H-5501
930T (LOADERS) S/N: 17B1000-2010 Hydraulic Oil Filter.....	H-5503	931C (LOADERS) S/N: 2B31-UP Hydraulic Oil Filter.....	H-55270	933 (LOADERS) S/N: 9EL1-UP Hydraulic Oil Filter.....	H-5504
Hydraulic Oil Filter.....	H-55280	931C (LOADERS) S/N: 5LG1-UP Hydraulic Oil Filter.....	H-55270	Hydraulic Oil Filter.....	H-55270
Hydraulic Oil Filter.....	H-5526	931C (LOADERS) S/N: 6RF1-UP Hydraulic Oil Filter.....	H-5504	933 (LOADERS) w/3046 Eng. Hydraulic Oil Filter.....	H-55320
930T (LOADERS) S/N: 5724000-UP Hydraulic Oil Filter.....	H-55280	931C (LOADERS) S/N: 7HF1-UP Hydraulic Oil Filter.....	H-55270	933C (LOADERS) CAT 3046 (S/N: 4MS1-UP) Hydraulic Oil Filter.....	HC-5504
Hydraulic Oil Filter.....	H-5526	931C (LOADERS) S/N: 8AF1-UP Hydraulic Oil Filter.....	H-5504	933C (LOADERS) CAT 3046 (S/N: 5JS1-UP) Hydraulic Oil Filter.....	HC-5504
Hydraulic Oil Filter.....	H-5503	931C (LOADERS) S/N: 8AF1-UP Hydraulic Oil Filter.....	H-55270	933C (LOADERS) CAT S/N: 4MS1-UP Hydraulic Oil Filter.....	HC-5504
930T SERIES II (LOADERS) S/N: 17B2011-UP Hydraulic Oil Filter.....	H-5503	931C (LOADERS) S/N: 8AF1-UP Hydraulic Oil Filter.....	H-5504	933C (LOADERS) CAT S/N: 5JS1-UP Hydraulic Oil Filter.....	HC-5504
Hydraulic Oil Filter.....	H-5526	931C (LOADERS) S/N: 8AF1-UP Hydraulic Oil Filter.....	H-55270	933C (LOADERS) CAT S/N: 5XK1-UP Hydraulic Oil Filter.....	HC-5504
Hydraulic Oil Filter.....	H-55280	931C (LOADERS) S/N: 8AF1-UP Hydraulic Oil Filter.....	H-5504	935B (LOADERS) S/N: 3DF1-UP Hydraulic Oil Filter.....	H-5504
931 (LOADERS) S/N: 10N1-UP Hydraulic Oil Filter.....	H-5504	931C (LOADERS) S/N: 8AF1-UP Hydraulic Oil Filter.....	H-55270	Hydraulic Oil Filter.....	H-55270
931 (LOADERS) S/N: 78U1-UP Hydraulic Oil Filter.....	H-5504	933 (LOADERS) S/N: 16G1-UP Hydraulic Oil Filter.....	H-5504	935B (LOADERS) w/3204 Eng. Hydraulic Oil Filter.....	H-55320
931B (LOADERS) CAT 3204 Hydraulic Oil Filter.....	H-5504	933 (LOADERS) S/N: 16G1-UP Hydraulic Oil Filter.....	H-5504	935C (LOADERS) S/N: 5DJ1-UP Hydraulic Oil Filter.....	H-5504
931B (LOADERS) S/N: 25Y1-UP Hydraulic Oil Filter.....	H-5504	933 (LOADERS) S/N: 16G1-UP Hydraulic Oil Filter.....	H-5504	935C (LOADERS) S/N: 5DJ1-UP Hydraulic Oil Filter.....	H-5504
Hydraulic Oil Filter.....	H-55270	933 (LOADERS) S/N: 16G1-UP Hydraulic Oil Filter.....	H-5504	935C (LOADERS) S/N: 8CF1-UP Hydraulic Oil Filter.....	H-5504
Hydraulic Oil Filter.....	H-55270	933 (LOADERS) S/N: 16G1-UP Hydraulic Oil Filter.....	H-5504	935C (LOADERS) S/N: 8CF1-UP Hydraulic Oil Filter.....	H-5504
931B (LOADERS) S/N: 26Y1-UP Hydraulic Oil Filter.....	H-55270	933 (LOADERS) S/N: 16G1-UP Hydraulic Oil Filter.....	H-5504	935C (LOADERS) S/N: 8CF1-UP Hydraulic Oil Filter.....	H-5504
Hydraulic Oil Filter.....	H-5504	933 (LOADERS) S/N: 16G1-UP Hydraulic Oil Filter.....	H-5504	935C (LOADERS) S/N: 8CF1-UP Hydraulic Oil Filter.....	H-5504
931B (LOADERS) S/N: 29Y1-UP Hydraulic Oil Filter.....	H-5504	933 (LOADERS) S/N: 16G1-UP Hydraulic Oil Filter.....	H-5504	935C (LOADERS) S/N: 8CF1-UP Hydraulic Oil Filter.....	H-5504
931B (LOADERS) S/N: 30Y1-UP Hydraulic Oil Filter.....	H-5504	933 (LOADERS) S/N: 16G1-UP Hydraulic Oil Filter.....	H-5504	935C (LOADERS) S/N: 8CF1-UP Hydraulic Oil Filter.....	H-5504
Hydraulic Oil Filter.....	H-55270	933 (LOADERS) S/N: 16G1-UP Hydraulic Oil Filter.....	H-5504	935C (LOADERS) S/N: 8CF1-UP Hydraulic Oil Filter.....	H-5504
Hydraulic Oil Filter.....	H-5504	933 (LOADERS) S/N: 16G1-UP Hydraulic Oil Filter.....	H-5504	935C (LOADERS) S/N: 8CF1-UP Hydraulic Oil Filter.....	H-5504
931B (LOADERS) S/N: 45C1-UP Hydraulic Oil Filter.....	H-55270	933 (LOADERS) S/N: 16G1-UP Hydraulic Oil Filter.....	H-5504	935C (LOADERS) S/N: 8CF1-UP Hydraulic Oil Filter.....	H-5504
Hydraulic Oil Filter.....	H-5504	933 (LOADERS) S/N: 16G1-UP Hydraulic Oil Filter.....	H-5504	935C (LOADERS) S/N: 8CF1-UP Hydraulic Oil Filter.....	H-5504
931B (LOADERS) S/N: 6EC1-UP Hydraulic Oil Filter.....	H-55270	933 (LOADERS) S/N: 16G1-UP Hydraulic Oil Filter.....	H-5504	935C (LOADERS) S/N: 8CF1-UP Hydraulic Oil Filter.....	H-5504
Hydraulic Oil Filter.....	H-5504	933 (LOADERS) S/N: 16G1-UP Hydraulic Oil Filter.....	H-5504	935C (LOADERS) S/N: 8CF1-UP Hydraulic Oil Filter.....	H-5504
931B (LOADERS) S/N: 9EL1-108 Hydraulic Oil Filter.....	H-5504	933 (LOADERS) S/N: 16G1-UP Hydraulic Oil Filter.....	H-5504	935C (LOADERS) S/N: 8CF1-UP Hydraulic Oil Filter.....	H-5504
931B (LOADERS) w/3204 Eng.		933 (LOADERS) S/N: 16G1-UP Hydraulic Oil Filter.....	H-5504	935C (LOADERS) S/N: 8CF1-UP Hydraulic Oil Filter.....	H-5504



ENGINE APPLICATION

MODEL/APPLICATION	SAKURA NO	MODEL/APPLICATION	SAKURA NO	MODEL/APPLICATION	SAKURA NO
CATERPILLAR		CATERPILLAR		CATERPILLAR	
936 (LOADERS) S/N: 45Z1-1359		938F (LOADERS) S/N: 1KM1-1799		938G (LOADERS) CAT 3126B ATAAC HEUI (S/N: 6WS683-UP)	
936 (LOADERS) S/N: 45Z1-3056		Hydraulic Oil Filter..... H-5506		Hydraulic Oil Filter..... H-5506	
Hydraulic Oil Filter..... H-5506		Hydraulic Oil Filter..... HC-5504		Hydraulic Oil Filter..... HC-5504	
936 (LOADERS) S/N: 45Z1360-2340		938F (LOADERS) S/N: 1KM1800-UP		938G (LOADERS) CAT 3126B ATAAC HEUI (S/N: 8RS1-610)	
Hydraulic Oil Filter..... H-5501		Hydraulic Oil Filter..... H-5506		Hydraulic Oil Filter..... HC-5504	
936 (LOADERS) S/N: 45Z2341-UP		Hydraulic Oil Filter..... HC-5504		Hydraulic Oil Filter..... H-5506	
Hydraulic Oil Filter..... H-5501		938F (LOADERS) S/N: 1KM1-UP		938G (LOADERS) CAT 3126B ATAAC HEUI (S/N: 8RS611-UP)	
936 (LOADERS) S/N: 45B1-UP		Hydraulic Oil Filter..... H-5506		Hydraulic Oil Filter..... H-5506	
Hydraulic Oil Filter..... H-5506		Hydraulic Oil Filter..... HC-5504		Hydraulic Oil Filter..... HC-5504	
936 (LOADERS) S/N: 45B1-UP		938F (LOADERS) S/N: 2RM1-1123		938G (LOADERS) CAT 3126B ATAAC HEUI (S/N: 9HS1-UP)	
Hydraulic Oil Filter..... H-5506		Hydraulic Oil Filter..... H-5506		Hydraulic Oil Filter..... H-5506	
936 (LOADERS) S/N: 45B-UP		Hydraulic Oil Filter..... HC-5508		Hydraulic Oil Filter..... HC-5504	
Hydraulic Oil Filter..... H-5506		Hydraulic Oil Filter..... HC-5504		938G (LOADERS) S/N: 4YS1-511	
936 (LOADERS) S/N: 45Z-UP		938F (LOADERS) S/N: 2RM1124-UP		Hydraulic Oil Filter..... HC-5504	
Hydraulic Oil Filter..... H-5506		Hydraulic Oil Filter..... HC-5508		Hydraulic Oil Filter..... H-5506	
936E (LOADERS) CAT 3304 (S/N: 33Z1-UP)		Hydraulic Oil Filter..... H-5506		938G (LOADERS) S/N: 4YS512-UP	
Hydraulic Oil Filter..... H-5506		Hydraulic Oil Filter..... HC-5504		Hydraulic Oil Filter..... H-5506	
936E (LOADERS) CAT 3304 (S/N: 45Z1-UP)		Hydraulic Oil Filter..... H-5506		Hydraulic Oil Filter..... HC-5504	
Hydraulic Oil Filter..... H-5506		938F (LOADERS) S/N: 7SN1-310		938G (LOADERS) S/N: 9HS1-280	
936E (LOADERS) S/N: 33Z3091-UP		Hydraulic Oil Filter..... HC-5508		Hydraulic Oil Filter..... H-5506	
Hydraulic Oil Filter..... H-5506		Hydraulic Oil Filter..... H-5506		Hydraulic Oil Filter..... HC-5504	
936E (LOADERS) S/N: 45Z3057-UP		938F (LOADERS) S/N: 7SN311-384		938G (LOADERS) S/N: 9HS281-743	
Hydraulic Oil Filter..... H-5506		Hydraulic Oil Filter..... HC-5504		Hydraulic Oil Filter..... HC-5504	
936E (LOADERS) S/N: 45B1623-UP		Hydraulic Oil Filter..... H-5506		Hydraulic Oil Filter..... H-5506	
Hydraulic Oil Filter..... H-5506		938F (LOADERS) S/N: 7SN385-UP		938G (LOADERS) S/N: 9HS744-UP	
936E (LOADERS) S/N: 45B1624-UP		Hydraulic Oil Filter..... HC-5504		Hydraulic Oil Filter..... H-5506	
Hydraulic Oil Filter..... H-5506		Hydraulic Oil Filter..... H-5506		Hydraulic Oil Filter..... HC-5504	
936F (LOADERS) S/N: 4TK1-UP		938F (LOADERS) S/N: 7SN1-UP		938H (LOADERS) w/C6.6 Eng.	
Hydraulic Oil Filter..... H-5506		Hydraulic Oil Filter..... H-5506		Hydraulic Oil Filter..... HC-55280	
936F (LOADERS) S/N: 8AJ1-UP		938F (LOADERS) S/N: 8SM1-UP		938G SERIES II (LOADERS) S/N: CRD1-UP	
Hydraulic Oil Filter..... H-5506		Hydraulic Oil Filter..... HC-5504		Hydraulic Oil Filter..... H-5506	
936F (LOADERS) S/N: 9MK1-UP		Hydraulic Oil Filter..... H-5506		Hydraulic Oil Filter..... HC-5504	
Hydraulic Oil Filter..... H-5506		938G (LOADERS) CAT 3126B ATAAC HEUI (S/N: 4YS1-UP)		938G SERIES II (LOADERS) S/N: PHN1-UP	
936F (LOADERS) S/N: 9MK1-UP		Hydraulic Oil Filter..... HC-5504		Hydraulic Oil Filter..... H-5506	
Hydraulic Oil Filter..... H-5506		Hydraulic Oil Filter..... H-5506		Hydraulic Oil Filter..... HC-5504	
936F (LOADERS) S/N: 9MK1-UP		938G (LOADERS) CAT 3126B ATAAC HEUI (S/N: 6WS1-682)		938G SERIES II (LOADERS) S/N: RTB1-UP	
Hydraulic Oil Filter..... H-5506		Hydraulic Oil Filter..... H-5506		Hydraulic Oil Filter..... H-5506	
936F (LOADERS) S/N: 9MK1-UP		Hydraulic Oil Filter..... HC-5504		Hydraulic Oil Filter..... HC-5504	



ENGINE APPLICATION

MODEL/APPLICATION	SAKURA NO	MODEL/APPLICATION	SAKURA NO	MODEL/APPLICATION	SAKURA NO
CATERPILLAR		CATERPILLAR		CATERPILLAR	
939 (LOADERS) CAT S/N: 5XK1-UP		Hydraulic Oil Filter.....	H-5504	944A (LOADERS) S/N: 58A1-UP	
Hydraulic Oil Filter.....	H-5501	941B (LOADERS) S/N: 80H3085-UP		Hydraulic Oil Filter.....	H-5503
Hydraulic Oil Filter.....	H-5504	Hydraulic Oil Filter.....	H-5504	950 (LOADERS) S/N: 31K1016-1200	
939 (LOADERS) CAT S/N: 9GL1-UP		Hydraulic Oil Filter.....	H-5508	Hydraulic Oil Filter.....	H-5504
Hydraulic Oil Filter.....	H-5504	941B (LOADERS) S/N: 80H3087-80H3087		Hydraulic Oil Filter.....	H-5503
Hydraulic Oil Filter.....	H-5501	Hydraulic Oil Filter.....	H-5504	950 (LOADERS) S/N: 31K1-1015	
939 (LOADERS)		Hydraulic Oil Filter.....	H-5508	Hydraulic Oil Filter.....	H-5504
Hydraulic Oil Filter.....	H-5508	941B (LOADERS) S/N: 80H3884-UP		Hydraulic Oil Filter.....	H-5503
939 (LOADERS) S/N: 9GL1-UP		Hydraulic Oil Filter.....	H-5504	950 (LOADERS) S/N: 31K1201-UP	
Hydraulic Oil Filter.....	H-5504	Hydraulic Oil Filter.....	H-5508	Hydraulic Oil Filter.....	H-5503
Hydraulic Oil Filter.....	H-55270	941B (LOADERS) S/N: 80H5702-80H5702		Hydraulic Oil Filter.....	H-5504
939 (LOADERS) w/3046 Eng.		Hydraulic Oil Filter.....	H-55270	950 (LOADERS) S/N: 81J1-4272	
Hydraulic Oil Filter.....	H-55320	Hydraulic Oil Filter.....	H-5504	Hydraulic Oil Filter.....	H-5503
939C (LOADERS) CAT 3046T (S/N: 6DS1-UP)		943 (LOADERS) S/N: 03Y1-1385		Hydraulic Oil Filter.....	H-5504
Hydraulic Oil Filter.....	HC-5504	Hydraulic Oil Filter.....	H-5506	950 (LOADERS) S/N: 81J4273-5410	
939C (LOADERS) CAT S/N: 5XK12250-UP		Hydraulic Oil Filter.....	H-5506	Hydraulic Oil Filter.....	H-5503
Hydraulic Oil Filter.....	HC-5504	943 (LOADERS) S/N: 03Y1386-UP		950 (LOADERS) S/N: 81J5411-UP	
939C (LOADERS) CAT S/N: 6DS1-UP		Hydraulic Oil Filter.....	H-5506	Hydraulic Oil Filter.....	H-5504
Hydraulic Oil Filter.....	HC-5504	Hydraulic Oil Filter.....	H-55280	Hydraulic Oil Filter.....	H-5503
941 (LOADERS) Except S/N 75H		943 (LOADERS) S/N: 19Z1-1378		950 (LOADERS) S/N: 90A1-UP	
Hydraulic Oil Filter.....	H-55320	Hydraulic Oil Filter.....	H-5506	Hydraulic Oil Filter.....	H-5503
941 (LOADERS) S/N: 16U1-UP		Hydraulic Oil Filter.....	H-55270	950 (LOADERS) w/3304 Eng.	
Hydraulic Oil Filter.....	H-5504	943 (LOADERS) S/N: 4Z1-UP		Hydraulic Oil Filter.....	H-55320
Hydraulic Oil Filter.....	H-5508	Hydraulic Oil Filter.....	H-5506	950F (LOADERS) S/N: 4DJ1-1999	
941 (LOADERS) S/N: 70H1-UP		Hydraulic Oil Filter.....	H-5503	Hydraulic Oil Filter.....	H-5506
Hydraulic Oil Filter.....	H-5504	943 LGP (LOADERS) S/N: 19Z1-252		950F (LOADERS) S/N: 4DJ-UP	
Hydraulic Oil Filter.....	H-5508	Hydraulic Oil Filter.....	H-5526	Hydraulic Oil Filter.....	H-5506
Hydraulic Oil Filter.....	H-5504	Hydraulic Oil Filter.....	H-5506	Hydraulic Oil Filter.....	H-5501
941 (LOADERS) S/N: 80H1-3039		Hydraulic Oil Filter.....	H-55280	950F (LOADERS) S/N: 5SK1-976	
Hydraulic Oil Filter.....	H-5508	Hydraulic Oil Filter.....	H-5526	Hydraulic Oil Filter.....	H-5506
Hydraulic Oil Filter.....	H-5504	943 LGP (LOADERS) S/N: 19Z253-UP		950F (LOADERS) S/N: 5SK2334-UP	
941 (LOADERS) S/N: 80H3087-UP		Hydraulic Oil Filter.....	H-5503	Hydraulic Oil Filter.....	H-5506
Hydraulic Oil Filter.....	H-5508	Hydraulic Oil Filter.....	H-5506	950F (LOADERS) S/N: 5SK977-2333	
Hydraulic Oil Filter.....	H-5504	Hydraulic Oil Filter.....	H-55280	Hydraulic Oil Filter.....	H-5506
941B (LOADERS) Except S/N 75H		Hydraulic Oil Filter.....	H-5526	950F (LOADERS) S/N: 5SK977-2333	
Hydraulic Oil Filter.....	H-55320	944 (LOADERS) S/N: 87J1-UP		Hydraulic Oil Filter.....	H-5506
941B (LOADERS) S/N: 80H3040-3084		Hydraulic Oil Filter.....	H-5503	950F (LOADERS) S/N: 5SK977-2333	
Hydraulic Oil Filter.....	H-5508	944A (LOADERS) S/N: 43A1-UP		Hydraulic Oil Filter.....	H-5506
		Hydraulic Oil Filter.....	H-5503	950F (LOADERS) S/N: 6YG1-UP	
				Hydraulic Oil Filter.....	H-55270



ENGINE APPLICATION

MODEL/APPLICATION	SAKURA NO	MODEL/APPLICATION	SAKURA NO	MODEL/APPLICATION	SAKURA NO
CATERPILLAR		CATERPILLAR		CATERPILLAR	
950F (LOADERS) S/N: 6YG1-UP		950B (LOADERS) S/N: 31R1-UP		950G (FOREST EQUIPMENTS) CAT 3126 (S/N: 2JS1-UP)	
Hydraulic Oil Filter.....	H-5506	Hydraulic Oil Filter.....	H-5506	Hydraulic Oil Filter.....	HC-5504
Hydraulic Oil Filter.....	H-5504			Hydraulic Oil Filter.....	HC-5505
950F (LOADERS) S/N: 6YG-UP		950B (LOADERS) S/N: 63R1-5857		950G (FOREST EQUIPMENTS) CAT 3126 (S/N: 3JW1-UP)	
Hydraulic Oil Filter.....	H-5501	Hydraulic Oil Filter.....	H-5501	Hydraulic Oil Filter.....	HC-5504
Hydraulic Oil Filter.....	H-5506				
950F (LOADERS) S/N: 7ZF1-UP		950B (LOADERS) S/N: 63R1-6053		950G (FOREST EQUIPMENTS) CAT 3126 (S/N: 4BS1-UP)	
Hydraulic Oil Filter.....	H-55270	Hydraulic Oil Filter.....	H-5506	Hydraulic Oil Filter.....	HC-5504
Hydraulic Oil Filter.....	H-5506				
950F (LOADERS) S/N: 7ZF-UP		950B (LOADERS) S/N: 63R5858-6054		950G (FOREST EQUIPMENTS) CAT 3126 (S/N: 5FW1-UP)	
Hydraulic Oil Filter.....	H-5506	Hydraulic Oil Filter.....	H-5501	Hydraulic Oil Filter.....	HC-5504
Hydraulic Oil Filter.....	H-5501				
950F (LOADERS) S/N: 8TK03917-UP		950B (LOADERS) S/N: 63R6055-9191		950G (FOREST EQUIPMENTS) CAT 3126 (S/N: 5MW1-UP)	
Hydraulic Oil Filter.....	H-5506	Hydraulic Oil Filter.....	H-5506	Hydraulic Oil Filter.....	HC-5504
Hydraulic Oil Filter.....	H-5501				
950F (LOADERS) S/N: 8TK1-310		950B (LOADERS) S/N: 63R9192-UP		950G (FOREST EQUIPMENTS) CAT 3126 (S/N: 6NS1-UP)	
Hydraulic Oil Filter.....	H-5506	Hydraulic Oil Filter.....	H-5506	Hydraulic Oil Filter.....	HC-5504
950F (LOADERS) S/N: 8TK2200-UP		950B (LOADERS) S/N: 65R1-UP		950G (FOREST EQUIPMENTS) CAT 3126 (S/N: 8JW1-UP)	
Hydraulic Oil Filter.....	H-5506	Hydraulic Oil Filter.....	H-5506	Hydraulic Oil Filter.....	HC-5504
950F (LOADERS) S/N: 8TK311-2199		950E (LOADERS) S/N: 22Z3189-UP		950G (FOREST EQUIPMENTS) CAT 3126B ATAAC HEUI (S/N: 6NS1-UP)	
Hydraulic Oil Filter.....	H-5506	Hydraulic Oil Filter.....	H-5506	Hydraulic Oil Filter.....	HC-5504
950F (LOADERS) S/N: 8TK-UP		950E (LOADERS) S/N: 22Z-UP		950G (FOREST EQUIPMENTS) S/N: 2JS1-940	
Hydraulic Oil Filter.....	H-5506	Hydraulic Oil Filter.....	H-5506	Hydraulic Oil Filter.....	HC-5504
Hydraulic Oil Filter.....	H-5501				
950B (LOADERS) S/N: 22Z1-3188		950E (LOADERS) S/N: 31R-UP		950G (FOREST EQUIPMENTS) S/N: 2JS941-UP	
Hydraulic Oil Filter.....	H-5506	Hydraulic Oil Filter.....	H-5506	Hydraulic Oil Filter.....	HC-55170
				Hydraulic Oil Filter.....	HC-5504
950B (LOADERS) S/N: 22Z1-811		950E (LOADERS) S/N: 63R6054-UP		Hydraulic Oil Filter.....	HC-5505
Hydraulic Oil Filter.....	H-5501	Hydraulic Oil Filter.....	H-5506		
950B (LOADERS) S/N: 22Z4827-5259		950E (LOADERS) S/N: 63R-UP		950G II (LOADERS) S/N: AXR1-UP	
Hydraulic Oil Filter.....	H-5501	Hydraulic Oil Filter.....	H-5506	Hydraulic Oil Filter.....	HC-5504
Hydraulic Oil Filter.....	H-5506				
950B (LOADERS) S/N: 22Z5260-5407		950E (LOADERS) S/N: 65R3088-UP		950G II (LOADERS) S/N: AYB1-UP	
Hydraulic Oil Filter.....	H-5506	Hydraulic Oil Filter.....	H-5506	Hydraulic Oil Filter.....	HC-55170
				Hydraulic Oil Filter.....	HC-5504
950B (LOADERS) S/N: 22Z5408-UP		950E (LOADERS) S/N: 65R3089-UP		Hydraulic Oil Filter.....	HC-5505
Hydraulic Oil Filter.....	H-5506	Hydraulic Oil Filter.....	H-5506		
950B (LOADERS) S/N: 22Z812-4826		950E (LOADERS) S/N: 65R-UP		950G II (LOADERS) S/N: AYL1-UP	
Hydraulic Oil Filter.....	H-5501	Hydraulic Oil Filter.....	H-5501	Hydraulic Oil Filter.....	HC-5504
				950G II (LOADERS) S/N: BAA1-UP	
				Hydraulic Oil Filter.....	HC-5504



ENGINE APPLICATION

MODEL/APPLICATION	SAKURA NO	MODEL/APPLICATION	SAKURA NO	MODEL/APPLICATION	SAKURA NO
CATERPILLAR		CATERPILLAR		CATERPILLAR	
950H (LOADERS) CAT S/N: C7C1-UP , 2006-UP Hydraulic Oil Filter.....	HC-5504	950F SERIES II (LOADERS) S/N: 5SK1990-UP Hydraulic Oil Filter.....	H-5506	Hydraulic Oil Filter.....	H-5508
950H (LOADERS) CAT S/N: K5K2-UP , 2006-UP Hydraulic Oil Filter.....	HC-5504	950F SERIES II (LOADERS) S/N: 5SK743-UP Hydraulic Oil Filter.....	H-5506	951C (LOADERS) S/N: 86J1992-2597 Hydraulic Oil Filter.....	H-5508
950H (LOADERS) CAT S/N: KHX1-UP , 2006-UP Hydraulic Oil Filter.....	HC-5504	950F SERIES II (LOADERS) S/N: 8TK1-4489 Hydraulic Oil Filter.....	H-5506	Hydraulic Oil Filter.....	H-5504
950H (LOADERS) CAT S/N: M1G1-UP , 2006-UP Hydraulic Oil Filter.....	HC-5504	950F SERIES II (LOADERS) S/N: 8TK1-815 Hydraulic Oil Filter.....	H-5506	951C (LOADERS) S/N: 86J2598-4041 Hydraulic Oil Filter.....	H-5508
950H (LOADERS) CAT S/N: N1A1-UP , 2006-UP Hydraulic Oil Filter.....	HC-5504	950F SERIES II (LOADERS) S/N: 8TK3231-4187 Hydraulic Oil Filter.....	H-5506	Hydraulic Oil Filter.....	H-5504
950H (LOADERS) w/C7 Eng. Hydraulic Oil Filter.....	HC-55280	950F SERIES II (LOADERS) S/N: 8TK4188-UP Hydraulic Oil Filter.....	H-5506	951C (LOADERS) S/N: 86J4042-UP Hydraulic Oil Filter.....	H-5508
950A (LOADERS) S/N: 81J1-4272 Hydraulic Oil Filter.....	H-5503	950F SERIES II (LOADERS) S/N: 8TK4490-UP Hydraulic Oil Filter.....	H-5506	Hydraulic Oil Filter.....	H-5504
Hydraulic Oil Filter.....	H-5504	950F SERIES II (LOADERS) S/N: 8TK816-3230 Hydraulic Oil Filter.....	H-5506	953 (LOADERS) S/N: 20Z1-UP Hydraulic Oil Filter.....	H-5503
950A (LOADERS) S/N: 81J4273-7845 Hydraulic Oil Filter.....	H-5503	951 (LOADERS) Hydraulic Oil Filter.....	H-55320	953 (LOADERS) S/N: 44Z1-UP Hydraulic Oil Filter.....	H-5506
Hydraulic Oil Filter.....	H-5504	951 (LOADERS) S/N: 69H1-UP Hydraulic Oil Filter.....	H-5504	Hydraulic Oil Filter.....	H-5526
950A (LOADERS) S/N: 81J7846-UP Hydraulic Oil Filter.....	H-5503	Hydraulic Oil Filter.....	H-5508	Hydraulic Oil Filter.....	H-55280
Hydraulic Oil Filter.....	H-5504	951B (LOADERS) Hydraulic Oil Filter.....	H-55320	Hydraulic Oil Filter.....	H-5503
950F SERIES II (LOADERS) S/N: 2LM1-187 Hydraulic Oil Filter.....	H-5506	951 (LOADERS) S/N: 69H1-1868 Hydraulic Oil Filter.....	H-5504	Hydraulic Oil Filter.....	H-5506
950F SERIES II (LOADERS) S/N: 2LM188-UP Hydraulic Oil Filter.....	H-5506	Hydraulic Oil Filter.....	H-5508	953 (LOADERS) S/N: 77Y1093-UP Hydraulic Oil Filter.....	H-5506
950F SERIES II (LOADERS) S/N: 2LM1-UP Hydraulic Oil Filter.....	H-5506	951B (LOADERS) S/N: 79H1-UP Hydraulic Oil Filter.....	H-5504	Hydraulic Oil Filter.....	H-5526
950F SERIES II (LOADERS) S/N: 4DJ2000-2864 Hydraulic Oil Filter.....	H-5506	Hydraulic Oil Filter.....	H-5508	Hydraulic Oil Filter.....	H-55280
950F SERIES II (LOADERS) S/N: 4DJ2865-3960 Hydraulic Oil Filter.....	H-5506	951B (LOADERS) S/N: 86J1-1991 Hydraulic Oil Filter.....	H-5504	953 (LOADERS) S/N: 78Y1061-UP Hydraulic Oil Filter.....	H-5503
950F SERIES II (LOADERS) S/N: 5SK1-1989 Hydraulic Oil Filter.....	H-5506	Hydraulic Oil Filter.....	H-5508	Hydraulic Oil Filter.....	H-5506
950F SERIES II (LOADERS) S/N: 5SK1-742 Hydraulic Oil Filter.....	H-5506	951C (LOADERS) Hydraulic Oil Filter.....	H-55320	Hydraulic Oil Filter.....	H-5526
		Hydraulic Oil Filter.....		Hydraulic Oil Filter.....	H-55280
		951C (LOADERS) S/N: 19H1-UP		953 LGP (LOADERS) S/N: 05Z1-UP	



ENGINE APPLICATION

MODEL/APPLICATION	SAKURA NO	MODEL/APPLICATION	SAKURA NO	MODEL/APPLICATION	SAKURA NO
CATERPILLAR		CATERPILLAR		CATERPILLAR	
953 LGP (LOADERS) S/N: 05Z1-UP		955 (LOADERS) S/N: 85J4737-85J4737		Hydraulic Oil Filter.....	H-55270
Hydraulic Oil Filter.....	H-55280	Hydraulic Oil Filter.....	H-5504	955L (LOADERS) w/3304 Eng.	
Hydraulic Oil Filter.....	H-5506	Hydraulic Oil Filter.....	H-5503	Hydraulic Oil Filter.....	H-55320
Hydraulic Oil Filter.....	H-5503	955 (LOADERS) S/N: 8Y1-UP		960F (LOADERS) S/N: 1YM1-UP	
Hydraulic Oil Filter.....	H-5526	Hydraulic Oil Filter.....	H-5506	Hydraulic Oil Filter.....	H-5506
953 LGP (LOADERS) S/N: 20Z1-266		Hydraulic Oil Filter.....	H-5504	960F (LOADERS) S/N: 4CL1-328	
Hydraulic Oil Filter.....	H-5506	955E (LOADERS) S/N: 12A8260-UP		Hydraulic Oil Filter.....	H-5506
Hydraulic Oil Filter.....	H-5503	Hydraulic Oil Filter.....	H-5503	960F (LOADERS) S/N: 4CL1-446	
Hydraulic Oil Filter.....	H-5526	955H (LOADERS) S/N: 60A1-UP		Hydraulic Oil Filter.....	H-5506
Hydraulic Oil Filter.....	H-55280	Hydraulic Oil Filter.....	H-5503	960F (LOADERS) S/N: 4CL329-UP	
953B (LOADERS) S/N: 5MK1-UP		955K (LOADERS) S/N: 61H1-UP		Hydraulic Oil Filter.....	H-5506
Hydraulic Oil Filter.....	H-5506	Hydraulic Oil Filter.....	H-5504	960F (LOADERS) S/N: 4CL447-UP	
Hydraulic Oil Filter.....	H-5503	955K (LOADERS) S/N: 85J1-4671		Hydraulic Oil Filter.....	H-5506
953C (LOADERS) CAT 3126B		Hydraulic Oil Filter.....	H-5503	960F (LOADERS) S/N: 6XL1-272	
Hydraulic Oil Filter.....	H-5506	Hydraulic Oil Filter.....	H-5504	Hydraulic Oil Filter.....	H-5506
953C (LOADERS) w/3126B Eng.		955L (LOADERS) S/N: 13X1-UP		960F (LOADERS) S/N: 6XL273-UP	
Hydraulic Oil Filter.....	HC-55280	Hydraulic Oil Filter.....	H-5504	Hydraulic Oil Filter.....	H-5506
953D (EXCAVATORS)		Excluding: S/N: 85J4732,4733,4737		960F (LOADERS) S/N: 9ZJ1-UP	
Hydraulic Oil Filter.....	H-5526	Hydraulic Oil Filter.....	H-5503	Hydraulic Oil Filter.....	H-5506
Hydraulic Oil Filter.....	H-5522	Hydraulic Oil Filter.....	H-5504	962G (LOADERS) CAT 3126B ATAAC HEUI (S/N: 3BS1-UP)	
Hydraulic Oil Filter.....	HC-5801	Hydraulic Oil Filter.....	H-55270	Hydraulic Oil Filter.....	HC-5504
Hydraulic Oil Filter.....	HC-55170	Hydraulic Oil Filter.....	H-55280	Hydraulic Oil Filter.....	HC-55170
953D III (LOADERS) S/N: LBP1-UP		955L (LOADERS) S/N: 57M1-UP		Hydraulic Oil Filter.....	HC-5505
Hydraulic Oil Filter.....	HC-5504	Hydraulic Oil Filter.....	H-5506	962G (LOADERS) CAT 3126B ATAAC HEUI (S/N: 4PW1-UP)	
953C WH (LOADERS) w/3126B Eng.		Hydraulic Oil Filter.....	H-5504	Hydraulic Oil Filter.....	HC-5504
Hydraulic Oil Filter.....	HC-55280	Hydraulic Oil Filter.....	H-5506	962G (LOADERS) CAT 3126B ATAAC HEUI (S/N: 5AS1-UP)	
955 (LOADERS) S/N: 12A1-8259		955L (LOADERS) S/N: 85J4672-4729		Hydraulic Oil Filter.....	HC-5504
Hydraulic Oil Filter.....	H-5503	Hydraulic Oil Filter.....	H-5504	962G (LOADERS) CAT 3126B ATAAC HEUI (S/N: 5RS1-226)	
955 (LOADERS) S/N: 13X1-UP		Hydraulic Oil Filter.....	H-5503	Hydraulic Oil Filter.....	HC-5504
Hydraulic Oil Filter.....	H-5504	955L (LOADERS) S/N: 85J4730-9509		962G (LOADERS) CAT 3126B ATAAC HEUI (S/N: 5RS227-UP)	
Hydraulic Oil Filter.....	H-5506	Hydraulic Oil Filter.....	H-55270	Hydraulic Oil Filter.....	HC-5504
955 (LOADERS) S/N: 57M1-UP		Hydraulic Oil Filter.....	H-5503	Hydraulic Oil Filter.....	HC-5504
Hydraulic Oil Filter.....	H-5504	Hydraulic Oil Filter.....	H-5504	962G (LOADERS) CAT 3126B ATAAC HEUI (S/N: 6EW1-UP)	
Hydraulic Oil Filter.....	H-5506	Hydraulic Oil Filter.....	H-55280	Hydraulic Oil Filter.....	HC-5504
955 (LOADERS) S/N: 85J1-4729		955L (LOADERS) S/N: 85J9510-UP		962G (LOADERS) CAT 3126B ATAAC HEUI (S/N: 6HW1-UP)	
Hydraulic Oil Filter.....	H-5503	Hydraulic Oil Filter.....	H-5504	Hydraulic Oil Filter.....	HC-5504
Hydraulic Oil Filter.....	H-5504	Hydraulic Oil Filter.....	H-55280	962G (LOADERS) CAT 3126B ATAAC HEUI (S/N: 6HW1-UP)	
955 (LOADERS) S/N: 85J4732-4733		Hydraulic Oil Filter.....	H-5503	Hydraulic Oil Filter.....	HC-5504
Hydraulic Oil Filter.....	H-5503	Hydraulic Oil Filter.....	H-5504	962G (LOADERS) CAT 3126B ATAAC HEUI (S/N: 6HW1-UP)	
Hydraulic Oil Filter.....	H-5504	Hydraulic Oil Filter.....	H-55280	Hydraulic Oil Filter.....	HC-5504
Hydraulic Oil Filter.....	H-5504	Hydraulic Oil Filter.....	H-5503		



ENGINE APPLICATION

MODEL/APPLICATION	SAKURA NO	MODEL/APPLICATION	SAKURA NO	MODEL/APPLICATION	SAKURA NO
CATERPILLAR		CATERPILLAR		CATERPILLAR	
962G (LOADERS) CAT 3126B ATAAC HEUI (S/N: 7BW1-UP)		963 (LOADERS) S/N: 48Z1-UP		Hydraulic Oil Filter.....	HC-55290
Hydraulic Oil Filter.....	HC-5504	Hydraulic Oil Filter.....	H-5503	Hydraulic Oil Filter.....	HC-5503
962G (LOADERS) CAT 3126B ATAAC HEUI (S/N: BDP1-UP)		963 (LOADERS) S/N: 6Z1-UP		Hydraulic Oil Filter.....	HC-5512
Hydraulic Oil Filter.....	HC-5504	Hydraulic Oil Filter.....	H-5506	Hydraulic Oil Filter.....	HC-5511
962G (LOADERS) S/N: 5AS1-217		963B (LOADERS) S/N: 9BL1-UP		Hydraulic Oil Filter.....	H-5506
Hydraulic Oil Filter.....	HC-5504	Hydraulic Oil Filter.....	H-55280	963C (LOADERS) S/N: BBD2912-2925-UP	
962G (LOADERS) S/N: 5AS218-UP		963C (LOADERS) S/N: 2DS1-2562-UP		Hydraulic Oil Filter.....	HC-5503
Hydraulic Oil Filter.....	HC-5504	Hydraulic Oil Filter.....	H-5506	Hydraulic Oil Filter.....	HC-5512
962H (LOADERS) CAT S/N: C7C1-UP , 2006-UP		Hydraulic Oil Filter.....	HC-5512	Hydraulic Oil Filter.....	HC-5511
Hydraulic Oil Filter.....	HC-5504	Hydraulic Oil Filter.....	HC-5506	Hydraulic Oil Filter.....	HC-5511
962H (LOADERS) CAT S/N: K6K1-UP , 2006-UP		Hydraulic Oil Filter.....	HC-55290	Hydraulic Oil Filter.....	H-5506
Hydraulic Oil Filter.....	HC-5504	Hydraulic Oil Filter.....	HC-5503	Hydraulic Oil Filter.....	HC-5512
962H (LOADERS) CAT S/N: KHX1-UP , 2006-UP		Hydraulic Oil Filter.....	HC-5511	Hydraulic Oil Filter.....	HC-55290
Hydraulic Oil Filter.....	HC-5504	963C (LOADERS) S/N: 2DS2563-UP		Hydraulic Oil Filter.....	HC-5506
962H (LOADERS) CAT S/N: M3G1-UP , 2006-UP		Hydraulic Oil Filter.....	HC-5512	Hydraulic Oil Filter.....	HC-5512
Hydraulic Oil Filter.....	HC-5504	Hydraulic Oil Filter.....	HC-5503	Hydraulic Oil Filter.....	HC-5503
962H (LOADERS) CAT S/N: N4A1-UP , 2006-UP		Hydraulic Oil Filter.....	H-5506	Hydraulic Oil Filter.....	H-5506
Hydraulic Oil Filter.....	HC-5504	Hydraulic Oil Filter.....	HC-5506	Hydraulic Oil Filter.....	HC-5506
962H (LOADERS) w/C7 Eng.		Hydraulic Oil Filter.....	HC-55290	Hydraulic Oil Filter.....	HC-5506
Hydraulic Oil Filter.....	HC-55280	Hydraulic Oil Filter.....	HC-5511	Hydraulic Oil Filter.....	HC-55290
962G II (LOADERS) S/N: AXS1-UP		Hydraulic Oil Filter.....	HC-5511	Hydraulic Oil Filter.....	HC-5511
Hydraulic Oil Filter.....	HC-5504	Hydraulic Oil Filter.....	H-5506	Hydraulic Oil Filter.....	HC-5506
962G II (LOADERS) S/N: AXY1-UP		Hydraulic Oil Filter.....	HC-5503	Hydraulic Oil Filter.....	H-5506
Hydraulic Oil Filter.....	HC-5504	Hydraulic Oil Filter.....	HC-5512	Hydraulic Oil Filter.....	HC-55290
962G II (LOADERS) S/N: AYE1-UP		Hydraulic Oil Filter.....	HC-5512	Hydraulic Oil Filter.....	HC-5506
Hydraulic Oil Filter.....	HC-5504	Hydraulic Oil Filter.....	HC-5511	Hydraulic Oil Filter.....	HC-55290
Hydraulic Oil Filter.....	HC-55170	963C (LOADERS) S/N: BBD2905-2905-UP		Hydraulic Oil Filter.....	HC-5506
Hydraulic Oil Filter.....	HC-5505	Hydraulic Oil Filter.....	HC-55290	963C (LOADERS) S/N: BBD2944-2945-UP	
962G II (LOADERS) S/N: BAB1-UP		Hydraulic Oil Filter.....	H-5506	Hydraulic Oil Filter.....	HC-5503
Hydraulic Oil Filter.....	HC-5504	Hydraulic Oil Filter.....	HC-5506	Hydraulic Oil Filter.....	HC-5512
962G II (LOADERS) S/N: BAD1-UP		Hydraulic Oil Filter.....	HC-5512	Hydraulic Oil Filter.....	HC-5511
Hydraulic Oil Filter.....	HC-5504	Hydraulic Oil Filter.....	HC-5503	Hydraulic Oil Filter.....	H-5506
963 (LOADERS) S/N: 11Z1-UP		Hydraulic Oil Filter.....	HC-5511	Hydraulic Oil Filter.....	HC-55290
Hydraulic Oil Filter.....	H-5506	Hydraulic Oil Filter.....	H-5506	Hydraulic Oil Filter.....	HC-5512
Hydraulic Oil Filter.....	H-55280	Hydraulic Oil Filter.....	HC-55290	Hydraulic Oil Filter.....	HC-5511
		Hydraulic Oil Filter.....	HC-5512	Hydraulic Oil Filter.....	H-5506
		Hydraulic Oil Filter.....	HC-5503	Hydraulic Oil Filter.....	HC-5506
		Hydraulic Oil Filter.....	HC-5506	Hydraulic Oil Filter.....	HC-5503
		963C (LOADERS) S/N: BBD2911-2911-UP		963C (LOADERS) w/3126B Eng.	
		Hydraulic Oil Filter.....	HC-5506		



ENGINE APPLICATION

MODEL/APPLICATION	SAKURA NO	MODEL/APPLICATION	SAKURA NO	MODEL/APPLICATION	SAKURA NO
CATERPILLAR		CATERPILLAR		CATERPILLAR	
963C (LOADERS) w/3126B Eng. Hydraulic Oil Filter.....	HC-55280	Hydraulic Oil Filter.....	H-55270	966D (LOADERS) S/N: 35S1-UP Hydraulic Oil Filter.....	H-5504
963 LGP (LOADERS) S/N: 21Z1-UP Hydraulic Oil Filter.....	H-5503	966C (LOADERS) S/N: 18B200-1265 Hydraulic Oil Filter.....	H-55280	Hydraulic Oil Filter.....	H-5506
Hydraulic Oil Filter.....	H-5506	Hydraulic Oil Filter.....	H-5504	Hydraulic Oil Filter.....	H-55270
963C WH (LOADERS) w/3126B Eng. Hydraulic Oil Filter.....	HC-55280	Hydraulic Oil Filter.....	H-55270	966D (LOADERS) S/N: 94X1-6488 Hydraulic Oil Filter.....	H-55270
966F SERIES II (LOADERS) S/N: 15L1665-UP Hydraulic Oil Filter.....	H-55270	Hydraulic Oil Filter.....	H-5503	Hydraulic Oil Filter.....	H-5506
Hydraulic Oil Filter.....	H-5506	966C (LOADERS) S/N: 18B374-UP Hydraulic Oil Filter.....	H-5504	Hydraulic Oil Filter.....	H-5504
966F SERIES II (LOADERS) S/N: 15L507-UP Hydraulic Oil Filter.....	H-55270	Hydraulic Oil Filter.....	H-5504	966D (LOADERS) S/N: 94X1-7031 Hydraulic Oil Filter.....	H-5504
Hydraulic Oil Filter.....	H-5506	966C (LOADERS) S/N: 30K1-1337 Hydraulic Oil Filter.....	H-5503	Hydraulic Oil Filter.....	H-5504
Hydraulic Oil Filter.....	H-5504	Hydraulic Oil Filter.....	H-5504	966D (LOADERS) S/N: 94X7032-UP Hydraulic Oil Filter.....	H-55270
966F SERIES II (LOADERS) S/N: 88G2000-2680 Hydraulic Oil Filter.....	H-5504	966C (LOADERS) S/N: 30K1338-1400 Hydraulic Oil Filter.....	H-5504	Hydraulic Oil Filter.....	H-5504
Hydraulic Oil Filter.....	H-5506	Hydraulic Oil Filter.....	H-5503	966D (LOADERS) S/N: 99Y1-3801 Hydraulic Oil Filter.....	H-55270
966F SERIES II (LOADERS) S/N: 9YJ1-UP Hydraulic Oil Filter.....	H-55270	Hydraulic Oil Filter.....	H-5503	Hydraulic Oil Filter.....	H-5504
Hydraulic Oil Filter.....	H-5504	966C (LOADERS) S/N: 30K1401-UP Hydraulic Oil Filter.....	H-5503	966D (LOADERS) S/N: 99Y1-5314 Hydraulic Oil Filter.....	H-5506
Hydraulic Oil Filter.....	H-5506	Hydraulic Oil Filter.....	H-5504	Hydraulic Oil Filter.....	H-55270
966 (LOADERS) S/N: 25Z1-UP Hydraulic Oil Filter.....	H-5506	966C (LOADERS) S/N: 76J1-4836 Hydraulic Oil Filter.....	H-5504	Hydraulic Oil Filter.....	H-5504
Hydraulic Oil Filter.....	H-5504	Hydraulic Oil Filter.....	H-5503	966D (LOADERS) S/N: 99Y3802-UP Hydraulic Oil Filter.....	H-55270
966 (LOADERS) S/N: 35S1-UP Hydraulic Oil Filter.....	H-5506	Hydraulic Oil Filter.....	H-5503	Hydraulic Oil Filter.....	H-55270
Hydraulic Oil Filter.....	H-5504	966C (LOADERS) S/N: 76J4837-5269 Hydraulic Oil Filter.....	H-5503	966D (LOADERS) S/N: 99Y3803-UP Hydraulic Oil Filter.....	H-55270
966C (LOADERS) S/N: 18B1016-UP Hydraulic Oil Filter.....	H-55270	Hydraulic Oil Filter.....	H-5504	Hydraulic Oil Filter.....	H-55270
Hydraulic Oil Filter.....	H-5503	966C (LOADERS) S/N: 76J5270-UP Hydraulic Oil Filter.....	H-5504	966D (LOADERS) w/3306 Eng. Hydraulic Oil Filter.....	H-55320
966C (LOADERS) S/N: 18B1-199 Hydraulic Oil Filter.....	H-5503	Hydraulic Oil Filter.....	H-5503	Hydraulic Oil Filter.....	H-55320
966C (LOADERS) S/N: 18B1266-UP Hydraulic Oil Filter.....	H-5503	966C (LOADERS) S/N: 9KC1-UP Hydraulic Oil Filter.....	H-5504	966E (LOADERS) w/3306 Eng. Hydraulic Oil Filter.....	H-55320
Hydraulic Oil Filter.....	H-5526	Hydraulic Oil Filter.....	H-55280	Hydraulic Oil Filter.....	H-55320
Hydraulic Oil Filter.....	H-55280	Hydraulic Oil Filter.....	H-5526	966F (LOADERS) S/N: 3XJ01192-UP , 1993 Hydraulic Oil Filter.....	H-5506
Hydraulic Oil Filter.....	H-55270	Hydraulic Oil Filter.....	H-55270	Hydraulic Oil Filter.....	H-5504
Hydraulic Oil Filter.....	H-5504	Hydraulic Oil Filter.....	H-5503	Hydraulic Oil Filter.....	HC-5505
966C (LOADERS) S/N: 18B200-1015 Hydraulic Oil Filter.....	H-5503	966C (LOADERS) S/N: T0-30K1337 Hydraulic Oil Filter.....	H-5503	966F (LOADERS) S/N: 15L1-1664 Hydraulic Oil Filter.....	H-5506
Hydraulic Oil Filter.....	H-5503	Hydraulic Oil Filter.....	H-5504	Hydraulic Oil Filter.....	H-55270
966C (LOADERS) S/N: 18B200-1015 Hydraulic Oil Filter.....	H-5503	966C (LOADERS) S/N: T0-76J4836 Hydraulic Oil Filter.....	H-5504	966F (LOADERS) S/N: 15L1-506 Hydraulic Oil Filter.....	H-55270
Hydraulic Oil Filter.....	H-5503	Hydraulic Oil Filter.....	H-5503	Hydraulic Oil Filter.....	H-5504
966C (LOADERS) S/N: 18B200-1015 Hydraulic Oil Filter.....	H-5503	966C (LOADERS) w/3306 Eng. Hydraulic Oil Filter.....	H-55320	Hydraulic Oil Filter.....	H-5506



ENGINE APPLICATION

MODEL/APPLICATION	SAKURA NO	MODEL/APPLICATION	SAKURA NO	MODEL/APPLICATION	SAKURA NO
CATERPILLAR		CATERPILLAR		CATERPILLAR	
966F (LOADERS) S/N: 4YG1-UP		Hydraulic Oil Filter.....	HC-5504	Hydraulic Oil Filter.....	H-55270
Hydraulic Oil Filter.....	H-55270	966G (LOADERS) S/N: 3ZS1-790		Hydraulic Oil Filter.....	HC-55170
Hydraulic Oil Filter.....	H-5506	Hydraulic Oil Filter.....	H-55270	Hydraulic Oil Filter.....	HC-5505
Hydraulic Oil Filter.....	H-5504	Hydraulic Oil Filter.....	HC-5504	966R (LOADERS) S/N: 58Z1-UP	
966F (LOADERS) S/N: 8BG1-UP		966G (LOADERS) S/N: 3ZS791-UP		Hydraulic Oil Filter.....	H-5526
Hydraulic Oil Filter.....	H-5506	Hydraulic Oil Filter.....	HC-5504	Hydraulic Oil Filter.....	H-5503
Hydraulic Oil Filter.....	H-5504	Hydraulic Oil Filter.....	H-55270	Hydraulic Oil Filter.....	H-5504
966F (LOADERS) S/N: 9YJ1-1984		Hydraulic Oil Filter.....	HC-5504	Hydraulic Oil Filter.....	H-55280
Hydraulic Oil Filter.....	H-5506	Hydraulic Oil Filter.....	H-55270	Hydraulic Oil Filter.....	H-55270
Hydraulic Oil Filter.....	H-5504	966G (LOADERS) S/N: 9RS1-1631		970F (LOADERS) CAT 3196 ATAAC-EUI (S/N: 7PL1-UP)	
966G (LOADERS) CAT 3306 (S/N: 3PW1-UP)		Hydraulic Oil Filter.....	H-55270	Hydraulic Oil Filter.....	H-55270
Hydraulic Oil Filter.....	HC-5504	Hydraulic Oil Filter.....	HC-5504	Hydraulic Oil Filter.....	H-5504
Hydraulic Oil Filter.....	H-5504	Hydraulic Oil Filter.....	HC-5505	Hydraulic Oil Filter.....	HC-5504
966G (LOADERS) CAT 3306 (S/N: 3SW1-UP)		Hydraulic Oil Filter.....	HC-55170	970F (LOADERS) CAT 3196 ATAAC-EUI (S/N: 7SK1-UP)	
Hydraulic Oil Filter.....	HC-5504	966G (LOADERS) S/N: 9RS1632-UP		Hydraulic Oil Filter.....	HC-5504
Hydraulic Oil Filter.....	H-5504	Hydraulic Oil Filter.....	H-55270	Hydraulic Oil Filter.....	H-5504
966G (LOADERS) CAT 3306 (S/N: 3ZS1-UP)		Hydraulic Oil Filter.....	HC-5504	Hydraulic Oil Filter.....	H-55270
Hydraulic Oil Filter.....	H-5504	966G (LOADERS) S/N: HDH1-28		970F (LOADERS) CAT 3196 ATAAC-EUI (S/N: 9JK1-UP)	
Hydraulic Oil Filter.....	HC-5504	Hydraulic Oil Filter.....	HC-5504	Hydraulic Oil Filter.....	H-55270
966G (LOADERS) CAT 3306 (S/N: 8XW1-346-UP)		Hydraulic Oil Filter.....	H-55270	Hydraulic Oil Filter.....	HC-5504
Hydraulic Oil Filter.....	H-5504	966G (LOADERS) S/N: HDH29-UP		Hydraulic Oil Filter.....	H-5504
Hydraulic Oil Filter.....	HC-5504	Hydraulic Oil Filter.....	HC-5504	970F (LOADERS) S/N: 9JK1-491	
966G (LOADERS) CAT 3306 (S/N: 8XW347-UP)		Hydraulic Oil Filter.....	HC-5504	Hydraulic Oil Filter.....	H-55270
Hydraulic Oil Filter.....	H-5504	966H (LOADERS) w/C11 Eng.		Hydraulic Oil Filter.....	H-5506
Hydraulic Oil Filter.....	HC-5504	Hydraulic Oil Filter.....	HC-55280	Hydraulic Oil Filter.....	H-5504
966G (LOADERS) CAT 3306 (S/N: 9RS1-UP)		966A (LOADERS) S/N: 33A1-UP		970F (LOADERS) S/N: 9JK492-UP	
Hydraulic Oil Filter.....	HC-5505	Hydraulic Oil Filter.....	H-5503	Hydraulic Oil Filter.....	H-5504
Hydraulic Oil Filter.....	H-5504	966A (LOADERS) S/N: 75A1-UP		Hydraulic Oil Filter.....	H-55270
Hydraulic Oil Filter.....	HC-5504	Hydraulic Oil Filter.....	H-5503	Hydraulic Oil Filter.....	H-5506
966G (LOADERS) CAT 3306 (S/N: AAH1-UP)		966G SERIES II (LOADERS) CAT 3176C ATAAC EUI (S/N: AXJ1-UP)		972G (LOADERS) S/N: 4WN1-856	
Hydraulic Oil Filter.....	HC-5504	Hydraulic Oil Filter.....	H-55270	Hydraulic Oil Filter.....	H-55270
Hydraulic Oil Filter.....	H-5504	Hydraulic Oil Filter.....	H-5504	Hydraulic Oil Filter.....	HC-5504
Hydraulic Oil Filter.....	H-5504	Hydraulic Oil Filter.....	HC-5504	972G (LOADERS) S/N: 4WN857-UP	
966G (LOADERS) CAT 3306 (S/N: HDH1-UP)		966G SERIES II (LOADERS) CAT S/N: ANT1-UP		Hydraulic Oil Filter.....	H-55270
Hydraulic Oil Filter.....	H-5504	Hydraulic Oil Filter.....	HC-5504	Hydraulic Oil Filter.....	HC-5504
Hydraulic Oil Filter.....	HC-5504	Hydraulic Oil Filter.....	H-55270	972G (LOADERS) S/N: 7LS1-465	
966G (LOADERS) S/N: 3SW1-1689		Hydraulic Oil Filter.....	HC-5504	Hydraulic Oil Filter.....	H-55270
Hydraulic Oil Filter.....	HC-5504	Hydraulic Oil Filter.....	H-55270	Hydraulic Oil Filter.....	HC-5504
Hydraulic Oil Filter.....	H-55270	966G SERIES II (LOADERS) CAT S/N: ANZ1-UP		972G (LOADERS) S/N: 7LS466-UP	
966G (LOADERS) S/N: 3SW1690-UP		Hydraulic Oil Filter.....	HC-5504	Hydraulic Oil Filter.....	HC-5504
Hydraulic Oil Filter.....	H-55270	Hydraulic Oil Filter.....	H-55270	Hydraulic Oil Filter.....	H-55270
966G (LOADERS) S/N: 3SW1690-UP		966G SERIES II (LOADERS) S/N: AMY1-UP		972H (LOADERS) w/C13 Eng.	
Hydraulic Oil Filter.....	H-55270	Hydraulic Oil Filter.....	HC-5504	Hydraulic Oil Filter.....	HC-55280



ENGINE APPLICATION

MODEL/APPLICATION	SAKURA NO	MODEL/APPLICATION	SAKURA NO	MODEL/APPLICATION	SAKURA NO
CATERPILLAR		CATERPILLAR		CATERPILLAR	
972H (LOADERS) w/C13 Eng.		973C (LOADERS) S/N: BCP1-UP		Hydraulic Oil Filter.....	H-5504
972E (PIPE LAYERS) S/N: 65A1-UP		Hydraulic Oil Filter.....	H-5506	980B (LOADERS) S/N: 89P1-1529	
Hydraulic Oil Filter.....	H-5504	Hydraulic Oil Filter.....	HC-5503	Hydraulic Oil Filter.....	H-5503
972G SERIES II (LOADERS) CAT 3196 ATAAC-EUI (S/N: AXC1-UP)		Hydraulic Oil Filter.....	HC-5512	Hydraulic Oil Filter.....	H-5504
Hydraulic Oil Filter.....	HC-55170	Hydraulic Oil Filter.....	HC-5506	980B (LOADERS) S/N: 89P1530-1878	
Hydraulic Oil Filter.....	H-5504	973C (LOADERS) S/N: LDX1-278-UP		Hydraulic Oil Filter.....	H-5503
Hydraulic Oil Filter.....	H-55270	Hydraulic Oil Filter.....	H-5506	Hydraulic Oil Filter.....	H-5504
Hydraulic Oil Filter.....	HC-5505	973C (LOADERS) S/N: LDX279-UP		980B (LOADERS) S/N: 89P1539-UP	
Hydraulic Oil Filter.....	HC-5504	Hydraulic Oil Filter.....	H-5506	Hydraulic Oil Filter.....	H-5503
972G SERIES II (LOADERS) CAT 3196 ATAAC-EUI (S/N: AXN1-UP)		973C (LOADERS) w/C9 Eng.		Hydraulic Oil Filter.....	H-5504
Hydraulic Oil Filter.....	HC-5504	Hydraulic Oil Filter.....	HC-55280	980B (LOADERS) S/N: 89P1879-4783	
Hydraulic Oil Filter.....	H-5504	973 LGP (LOADERS) S/N: 86G1-UP		Hydraulic Oil Filter.....	H-5504
Hydraulic Oil Filter.....	H-55270	Hydraulic Oil Filter.....	H-5506	Hydraulic Oil Filter.....	H-5503
972G SERIES II (LOADERS) S/N: ANY1-UP		Hydraulic Oil Filter.....	H-5503	980B (LOADERS) S/N: 89P4784-UP	
Hydraulic Oil Filter.....	HC-5504	973C WH (LOADERS) w/C9 Eng.		Hydraulic Oil Filter.....	H-5504
Hydraulic Oil Filter.....	H-55270	Hydraulic Oil Filter.....	HC-55280	Hydraulic Oil Filter.....	H-5503
972G SERIES II (LOADERS) S/N: AWP1-UP		977 (LOADERS) S/N: 14X1-806		980B (LOADERS) S/N: 89P1539-EXC 89P1539	
Hydraulic Oil Filter.....	HC-5504	Hydraulic Oil Filter.....	H-5503	Hydraulic Oil Filter.....	H-5503
Hydraulic Oil Filter.....	H-55270	Hydraulic Oil Filter.....	H-5506	Hydraulic Oil Filter.....	H-5504
973 (LOADERS) S/N: 26Z1-UP		977 (LOADERS) S/N: 14X807-UP		980C (LOADERS) S/N: 13B300-UP	
Hydraulic Oil Filter.....	H-55280	Hydraulic Oil Filter.....	H-5506	Hydraulic Oil Filter.....	H-5504
Hydraulic Oil Filter.....	H-5506	Hydraulic Oil Filter.....	H-5506	Hydraulic Oil Filter.....	H-5506
973 (LOADERS) S/N: 32Z1-UP		Hydraulic Oil Filter.....	H-5503	980C (LOADERS) S/N: 2EB1-UP	
Hydraulic Oil Filter.....	H-5506	977 (LOADERS) S/N: 20A-20A		Hydraulic Oil Filter.....	H-5506
Hydraulic Oil Filter.....	H-55280	Hydraulic Oil Filter.....	H-5503	Hydraulic Oil Filter.....	H-5504
973 (LOADERS) S/N: 86G1-UP		977H (LOADERS) S/N: 53A1-UP		980C (LOADERS) S/N: 2XD1-UP	
Hydraulic Oil Filter.....	H-55280	Hydraulic Oil Filter.....	H-5503	Hydraulic Oil Filter.....	H-55270
Hydraulic Oil Filter.....	H-5506	977K (LOADERS) S/N: 11K1-3918		Hydraulic Oil Filter.....	H-5504
Hydraulic Oil Filter.....	H-5506	Hydraulic Oil Filter.....	H-5503	Hydraulic Oil Filter.....	H-5506
973 (LOADERS) S/N: 91L1-UP		Hydraulic Oil Filter.....	H-5506	980C (LOADERS) S/N: 5XJ1-UP	
Hydraulic Oil Filter.....	H-5506	977L (LOADERS) S/N: 11K4071-UP		Hydraulic Oil Filter.....	H-5506
Hydraulic Oil Filter.....	H-5503	Hydraulic Oil Filter.....	H-5503	Hydraulic Oil Filter.....	H-5504
973C (LOADERS) S/N: 3RZ1-639-UP		977L (LOADERS) S/N: 95X1-UP		980C (LOADERS) S/N: 63X1-2818	
Hydraulic Oil Filter.....	HC-5512	Hydraulic Oil Filter.....	H-5503	Hydraulic Oil Filter.....	H-55270
Hydraulic Oil Filter.....	H-5506	Hydraulic Oil Filter.....	H-5506	980C (LOADERS) S/N: 63X2819-5062	
Hydraulic Oil Filter.....	HC-5506	977L (LOADERS) S/N: 95X1-UP		Hydraulic Oil Filter.....	H-5506
Hydraulic Oil Filter.....	HC-5503	Hydraulic Oil Filter.....	H-5506	Hydraulic Oil Filter.....	H-5504
973C (LOADERS) S/N: 3RZ640-UP		980 (LOADERS) S/N: 42H1-UP		980C (LOADERS) S/N: 63X2819-5062	
Hydraulic Oil Filter.....	HC-5506	Hydraulic Oil Filter.....	H-5503	Hydraulic Oil Filter.....	H-55270
Hydraulic Oil Filter.....	HC-5512	Hydraulic Oil Filter.....	H-5506		
Hydraulic Oil Filter.....	HC-5503				
Hydraulic Oil Filter.....	H-5506				



ENGINE APPLICATION

MODEL/APPLICATION	SAKURA NO	MODEL/APPLICATION	SAKURA NO	MODEL/APPLICATION	SAKURA NO
CATERPILLAR		CATERPILLAR		CATERPILLAR	
980C (LOADERS) S/N: 63X5063-5184		Hydraulic Oil Filter.....	H-5504	980G (LOADERS) CAT 3406E ATAAC EUI (S/N: 2SR1-UP)	
Hydraulic Oil Filter.....	H-55270	980F (LOADERS) S/N: 5XJ-UP		Hydraulic Oil Filter.....	H-5506
Hydraulic Oil Filter.....	H-5506	Hydraulic Oil Filter.....	H-5506	Hydraulic Oil Filter.....	H-55270
980C (LOADERS) S/N: 63X5185-6474		Hydraulic Oil Filter.....	H-5504	Hydraulic Oil Filter.....	H-5504
Hydraulic Oil Filter.....	H-5506	980F (LOADERS) S/N: 8CJ1-540		980G (LOADERS) CAT 3406E ATAAC EUI (S/N: 2SR651-UP)	
980C (LOADERS) S/N: 63X6475-6547		Hydraulic Oil Filter.....	H-5506	Hydraulic Oil Filter.....	H-5506
Hydraulic Oil Filter.....	H-5506	Hydraulic Oil Filter.....	H-55270	980G (LOADERS) CAT 3406E ATAAC EUI (S/N: 9CM1125-1422)	
980C (LOADERS) S/N: 63X6548-6548		980F (LOADERS) S/N: 8CJ1-UP		Hydraulic Oil Filter.....	H-5504
Hydraulic Oil Filter.....	H-55270	Hydraulic Oil Filter.....	H-5504	Hydraulic Oil Filter.....	H-5506
Hydraulic Oil Filter.....	H-5506	Hydraulic Oil Filter.....	H-55270	980G (LOADERS) CAT 3406E ATAAC EUI (S/N: 9CM1-UP)	
Hydraulic Oil Filter.....	H-5504	980F (LOADERS) S/N: 8CJ541-UP		Hydraulic Oil Filter.....	H-5506
980C (LOADERS) S/N: 63X6549-6574		Hydraulic Oil Filter.....	H-5506	Hydraulic Oil Filter.....	H-5504
Hydraulic Oil Filter.....	H-5506	Hydraulic Oil Filter.....	H-55270	980G (LOADERS) S/N: 2KR1-505	
980C (LOADERS) S/N: 63X6575-8791		980F (LOADERS) S/N: 8CJ-UP		Hydraulic Oil Filter.....	H-55270
Hydraulic Oil Filter.....	H-55270	Hydraulic Oil Filter.....	H-5504	Hydraulic Oil Filter.....	H-5506
Hydraulic Oil Filter.....	H-5504	Hydraulic Oil Filter.....	H-5506	980G (LOADERS) S/N: 2KR3565-UP	
Hydraulic Oil Filter.....	H-5506	980F (LOADERS) S/N: 8NJ-UP		Hydraulic Oil Filter.....	H-5506
980C (LOADERS) S/N: 63X8792-8862		Hydraulic Oil Filter.....	H-5504	Hydraulic Oil Filter.....	H-55270
Hydraulic Oil Filter.....	H-55270	Hydraulic Oil Filter.....	H-5506	980G (LOADERS) S/N: 2KR506-3564	
Hydraulic Oil Filter.....	H-5504	980G (LOADERS) CAT 3406C (S/N: 2KR1-UP)		Hydraulic Oil Filter.....	H-55270
Hydraulic Oil Filter.....	H-5506	Hydraulic Oil Filter.....	H-5504	Hydraulic Oil Filter.....	H-5506
980C (LOADERS) S/N: 63X8863-UP		980G (LOADERS) CAT 3406C (S/N: 2SR1-650)		980G (LOADERS) S/N: 9CM1-372	
Hydraulic Oil Filter.....	H-5506	Hydraulic Oil Filter.....	H-5506	Hydraulic Oil Filter.....	H-55270
Hydraulic Oil Filter.....	H-5504	980G (LOADERS) CAT 3406C (S/N: 2KR1-UP)		Hydraulic Oil Filter.....	H-5504
Hydraulic Oil Filter.....	H-55270	Hydraulic Oil Filter.....	H-5504	Hydraulic Oil Filter.....	H-5506
980F (LOADERS) CAT 3406 DIT		980G (LOADERS) S/N: 8CJ-UP		980G (LOADERS) S/N: 9CM2142-UP	
Hydraulic Oil Filter.....	H-5504	Hydraulic Oil Filter.....	H-5504	Hydraulic Oil Filter.....	H-55270
Hydraulic Oil Filter.....	H-5506	980G (LOADERS) CAT 3406C (S/N: 2SR651-UP)		Hydraulic Oil Filter.....	H-5504
980F (LOADERS) S/N: 3HK1-720		Hydraulic Oil Filter.....	H-5506	Hydraulic Oil Filter.....	H-5506
Hydraulic Oil Filter.....	H-55270	980G (LOADERS) CAT 3406C (S/N: 9CM1-UP)		980G (LOADERS) S/N: 9CM373-2141	
Hydraulic Oil Filter.....	H-5504	Hydraulic Oil Filter.....	H-5506	Hydraulic Oil Filter.....	H-55270
980F (LOADERS) S/N: 3HK1-UP		Hydraulic Oil Filter.....	H-5504	Hydraulic Oil Filter.....	H-5506
Hydraulic Oil Filter.....	H-5506	980G (LOADERS) CAT 3406E ATAAC EUI (S/N: 2KR1-UP)		Hydraulic Oil Filter.....	H-5504
Hydraulic Oil Filter.....	H-55270	Hydraulic Oil Filter.....	H-5506	980F SERIES II (LOADERS) S/N: 5XJ617-UP	
Hydraulic Oil Filter.....	H-5504	Hydraulic Oil Filter.....	H-55270	Hydraulic Oil Filter.....	H-5504
980F (LOADERS) S/N: 3HK721-UP		Hydraulic Oil Filter.....	H-5504	Hydraulic Oil Filter.....	H-5506
Hydraulic Oil Filter.....	H-55270	980G (LOADERS) CAT 3406E ATAAC EUI (S/N: 2KR500-UP)		Hydraulic Oil Filter.....	H-55270
Hydraulic Oil Filter.....	H-5504	Hydraulic Oil Filter.....	H-5506	980F SERIES II (LOADERS) S/N: 8JN1-UP	
980F (LOADERS) S/N: 3HK-UP		Hydraulic Oil Filter.....	H-5504	Hydraulic Oil Filter.....	H-5506
Hydraulic Oil Filter.....	H-5506			Hydraulic Oil Filter.....	H-55270



ENGINE APPLICATION

MODEL/APPLICATION	SAKURA NO	MODEL/APPLICATION	SAKURA NO	MODEL/APPLICATION	SAKURA NO
CATERPILLAR		CATERPILLAR		CATERPILLAR	
980F SERIES II (LOADERS) S/N: 8JN1-UP Hydraulic Oil Filter.....	H-5504	988B (LOADERS) S/N: 50W8225-9164 Hydraulic Oil Filter.....	H-55270	988F SERIES II (LOADERS) S/N: 2ZR1-UP Hydraulic Oil Filter.....	H-55270
980G SERIES II (LOADERS) CAT 3406E ATAAC EUI (S/N: AWH1-UP) Hydraulic Oil Filter.....	H-55270	988B (LOADERS) S/N: 50W9165-UP Hydraulic Oil Filter.....	H-55270	Hydraulic Oil Filter.....	HC-5504
Hydraulic Oil Filter.....	H-5504	988B (LOADERS) w/3408 Eng. Hydraulic Oil Filter.....	H-55320	Hydraulic Oil Filter.....	H-5509
980G SERIES II (LOADERS) S/N: AWH1-759 Hydraulic Oil Filter.....	H-55270	988F (LOADERS) S/N: 8YG1-UP Hydraulic Oil Filter.....	H-5509	990 (LOADERS) CAT 3412E HEUI Hydraulic Oil Filter.....	H-5506
980G SERIES II (LOADERS) S/N: AWH760-UP Hydraulic Oil Filter.....	H-55270	Hydraulic Oil Filter.....	H-5504	990 (LOADERS) CAT 3412E HEUI (S/N: 7HK1-UP) Hydraulic Oil Filter.....	H-5526
980G SERIES II (LOADERS) S/N: AXG1-UP Hydraulic Oil Filter.....	H-55270	Hydraulic Oil Filter.....	H-55270	Hydraulic Oil Filter.....	H-5506
Hydraulic Oil Filter.....	H-5504	988F II (LOADERS) S/N: 2ZR1-UP Hydraulic Oil Filter.....	H-5504	990H (LOADERS) CAT S/N: BWX1-UP , 2006-UP Hydraulic Oil Filter.....	H-55280
983 (LOADERS) S/N: 38K1-UP Hydraulic Oil Filter.....	H-5503	988G (LOADERS) CAT 3456 ATAAC-EUI (S/N: 2TW1-UP) Hydraulic Oil Filter.....	HC-5512	Hydraulic Oil Filter.....	H-5506
988 (LOADERS) S/N: 87A9075-UP Hydraulic Oil Filter.....	H-5503	Hydraulic Oil Filter.....	HC-5504	Hydraulic Oil Filter.....	HC-5504
988B (LOADERS) CAT S/N: 48W8433-UP Hydraulic Oil Filter.....	H-5509	988G (LOADERS) CAT 3456 ATAAC-EUI (S/N: BNH1-UP) Hydraulic Oil Filter.....	HC-5504	Hydraulic Oil Filter.....	H-5506
988B (LOADERS) CAT S/N: 50W4034-UP Hydraulic Oil Filter.....	H-5509	Hydraulic Oil Filter.....	HC-5512	Hydraulic Oil Filter.....	H-5526
988B (LOADERS) S/N: 50W1-1285 Hydraulic Oil Filter.....	H-55270	988G (LOADERS) S/N: 1NZ1-UP Hydraulic Oil Filter.....	HC-5512	Hydraulic Oil Filter.....	H-5506
988B (LOADERS) S/N: 50W1286-1492 Hydraulic Oil Filter.....	H-55270	Hydraulic Oil Filter.....	H-55270	Hydraulic Oil Filter.....	H-5506
988B (LOADERS) S/N: 50W1493-6040 Hydraulic Oil Filter.....	H-55270	Hydraulic Oil Filter.....	HC-5506	Hydraulic Oil Filter.....	H-5506
988B (LOADERS) S/N: 50W1-UP Hydraulic Oil Filter.....	H-5504	Hydraulic Oil Filter.....	HC-5504	Hydraulic Oil Filter.....	H-5526
988B (LOADERS) S/N: 50W6041-8176 Hydraulic Oil Filter.....	H-55270	988H (LOADERS) CAT S/N: BXY1-UP , 2006-UP Hydraulic Oil Filter.....	HC-5512	990 SERIES II (LOADERS) CAT 3412E HEUI (S/N: 4FR1-UP) Hydraulic Oil Filter.....	H-5506
988B (LOADERS) S/N: 50W8177-8184 Hydraulic Oil Filter.....	H-55270	Hydraulic Oil Filter.....	HC-5504	Hydraulic Oil Filter.....	H-5526
988B (LOADERS) S/N: 50W8185-8224 Hydraulic Oil Filter.....	H-55270	988H (LOADERS) CAT S/N: RHX1-UP , 2006-UP Hydraulic Oil Filter.....	HC-5512	990 SERIES II (LOADERS) S/N: BCR1-UP Hydraulic Oil Filter.....	H-55280
		Hydraulic Oil Filter.....	HC-5504	Hydraulic Oil Filter.....	H-5506
		988A (LOADERS) S/N: 87A1-1308 Hydraulic Oil Filter.....	H-5503	Hydraulic Oil Filter.....	H-5526
		988A (LOADERS) S/N: 87A1309-1878 Hydraulic Oil Filter.....	H-5503	992C (LOADERS) S/N: 42X1-647 Hydraulic Oil Filter.....	H-5526
		988A (LOADERS) S/N: 87A1879-5627 Hydraulic Oil Filter.....	H-5503	Hydraulic Oil Filter.....	H-5508
		988A (LOADERS) S/N: 87A5628-UP Hydraulic Oil Filter.....	H-5503	992C (LOADERS) S/N: 42X648-899 Hydraulic Oil Filter.....	H-5508
		988A (LOADERS) S/N: 87A5628-UP Hydraulic Oil Filter.....	H-5503	Hydraulic Oil Filter.....	H-5526
				Hydraulic Oil Filter.....	H-55280
				992C (LOADERS) S/N: 42X900-UP	



ENGINE APPLICATION

MODEL/APPLICATION	SAKURA NO	MODEL/APPLICATION	SAKURA NO	MODEL/APPLICATION	SAKURA NO
CATERPILLAR		CATERPILLAR		CATERPILLAR	
992C (LOADERS) S/N: 42X900-UP		992D (LOADERS) S/N: 7MJ148-UP		992B (LOADERS) S/N: 25K1170-UP	
Hydraulic Oil Filter.....	H-55280	Hydraulic Oil Filter.....	H-5503	Hydraulic Oil Filter.....	H-5508
Hydraulic Oil Filter.....	H-5508	Hydraulic Oil Filter.....	H-5508	Hydraulic Oil Filter.....	H-5503
Hydraulic Oil Filter.....	H-5526	Hydraulic Oil Filter.....	H-55280		
Hydraulic Oil Filter.....	H-55270	Hydraulic Oil Filter.....	H-5509	994 (LOADERS) S/N: 54Z1-UP	
Hydraulic Oil Filter.....	H-5504	Hydraulic Oil Filter.....	H-5526	Hydraulic Oil Filter.....	H-5503
		Hydraulic Oil Filter.....	H-55270	Hydraulic Oil Filter.....	H-5506
		Hydraulic Oil Filter.....	H-5504	Hydraulic Oil Filter.....	H-55280
992C (LOADERS) S/N: 49Z1176-UP		992D (LOADERS) S/N: 7MJ1-UP		994 (LOADERS) S/N: 9TF1-UP	
Hydraulic Oil Filter.....	H-5503	Hydraulic Oil Filter.....	H-55270	Hydraulic Oil Filter.....	H-5526
Hydraulic Oil Filter.....	H-5504	Hydraulic Oil Filter.....	H-55280	Hydraulic Oil Filter.....	H-5504
Hydraulic Oil Filter.....	H-5508	Hydraulic Oil Filter.....	H-5509	Hydraulic Oil Filter.....	H-55270
Hydraulic Oil Filter.....	H-5526	Hydraulic Oil Filter.....	H-5508	Hydraulic Oil Filter.....	H-5503
Hydraulic Oil Filter.....	H-55270	Hydraulic Oil Filter.....	H-5526	Hydraulic Oil Filter.....	H-55280
Hydraulic Oil Filter.....	H-55280	Hydraulic Oil Filter.....	H-5504	Hydraulic Oil Filter.....	HC-5504
		Hydraulic Oil Filter.....	H-5503		
992C (LOADERS) S/N: 49Z1-560		992D (LOADERS) S/N: 7MJ1-UP		994 (LOADERS) S/N: 9YF1-UP	
Hydraulic Oil Filter.....	H-5526	Hydraulic Oil Filter.....	H-55270	Hydraulic Oil Filter.....	H-5526
Hydraulic Oil Filter.....	H-5508	Hydraulic Oil Filter.....	H-55280	Hydraulic Oil Filter.....	HC-5508
Hydraulic Oil Filter.....	H-55280	Hydraulic Oil Filter.....	H-5509	Hydraulic Oil Filter.....	H-5526
Hydraulic Oil Filter.....	H-5504	Hydraulic Oil Filter.....	H-5508	Hydraulic Oil Filter.....	H-55270
Hydraulic Oil Filter.....	H-55270	Hydraulic Oil Filter.....	H-5526	Hydraulic Oil Filter.....	H-55280
		Hydraulic Oil Filter.....	H-5504	Hydraulic Oil Filter.....	H-55280
		Hydraulic Oil Filter.....	H-5503		
992C (LOADERS) S/N: 49Z1-UP		992G (LOADERS) CAT 3508B EUI (S/N: 7HR1-UP)		994 (LOADERS) S/N: 9Y56-109	
Hydraulic Oil Filter.....	H-5509	Hydraulic Oil Filter.....	HC-5504	Hydraulic Oil Filter.....	H-55280
Hydraulic Oil Filter.....	H-5504	Hydraulic Oil Filter.....	H-5526	Hydraulic Oil Filter.....	HC-5508
Hydraulic Oil Filter.....	H-5503	Hydraulic Oil Filter.....	HC-5512	Hydraulic Oil Filter.....	H-55270
				Hydraulic Oil Filter.....	H-5526
				Hydraulic Oil Filter.....	HC-5504
				Hydraulic Oil Filter.....	H-55270
				Hydraulic Oil Filter.....	HC-5504
992C (LOADERS) S/N: 49Z561-977		992G (LOADERS) CAT 3508B EUI (S/N: ADZ1-UP)		994 (LOADERS) S/N: 9YF110-UP	
Hydraulic Oil Filter.....	H-55270	Hydraulic Oil Filter.....	H-5526	Hydraulic Oil Filter.....	H-5526
Hydraulic Oil Filter.....	H-5508	Hydraulic Oil Filter.....	HC-5504	Hydraulic Oil Filter.....	HC-5504
Hydraulic Oil Filter.....	H-5526	Hydraulic Oil Filter.....	HC-5512	Hydraulic Oil Filter.....	H-55270
Hydraulic Oil Filter.....	H-55280			Hydraulic Oil Filter.....	H-5526
Hydraulic Oil Filter.....	H-5504			Hydraulic Oil Filter.....	HC-5504
				Hydraulic Oil Filter.....	H-55270
				Hydraulic Oil Filter.....	H-55280
992C (LOADERS) S/N: 49Z978-1175		992G (LOADERS) S/N: ADZ1-540		994 (LOADERS) S/N: 9YF1-19	
Hydraulic Oil Filter.....	H-5508	Hydraulic Oil Filter.....	HC-5512	Hydraulic Oil Filter.....	HC-5504
Hydraulic Oil Filter.....	H-5526	Hydraulic Oil Filter.....	H-5526	Hydraulic Oil Filter.....	H-55280
Hydraulic Oil Filter.....	H-55280	Hydraulic Oil Filter.....	H-55280	Hydraulic Oil Filter.....	H-55270
Hydraulic Oil Filter.....	H-5504	Hydraulic Oil Filter.....	HC-5504	Hydraulic Oil Filter.....	H-55280
Hydraulic Oil Filter.....	H-55270				
992C (LOADERS) w/3412 Eng.		992G (LOADERS) S/N: ADZ541-UP		994 (LOADERS) S/N: 9YF1-19	
Hydraulic Oil Filter.....	H-55320	Hydraulic Oil Filter.....	HC-5504	Hydraulic Oil Filter.....	HC-5504
		Hydraulic Oil Filter.....	H-5526	Hydraulic Oil Filter.....	H-55280
		Hydraulic Oil Filter.....	HC-5512	Hydraulic Oil Filter.....	H-55270
		Hydraulic Oil Filter.....	H-55280	Hydraulic Oil Filter.....	H-5526
992D (LOADERS) S/N: 7MJ1-147		992G (LOADERS) S/N: AZX1-UP		994 (LOADERS) S/N: 9YF20-20	
Hydraulic Oil Filter.....	H-5504	Hydraulic Oil Filter.....	HC-5504	Hydraulic Oil Filter.....	H-55270
Hydraulic Oil Filter.....	H-5508	Hydraulic Oil Filter.....	H-5526	Hydraulic Oil Filter.....	H-55280
Hydraulic Oil Filter.....	H-5526	Hydraulic Oil Filter.....	HC-5512	Hydraulic Oil Filter.....	HC-5504
Hydraulic Oil Filter.....	H-55280	Hydraulic Oil Filter.....	H-55280		
Hydraulic Oil Filter.....	H-55270				
Hydraulic Oil Filter.....	H-5509				
Hydraulic Oil Filter.....	H-5503				



ENGINE APPLICATION

MODEL/APPLICATION	SAKURA NO	MODEL/APPLICATION	SAKURA NO	MODEL/APPLICATION	SAKURA NO
CATERPILLAR		CATERPILLAR		CATERPILLAR	
994 (LOADERS) S/N: 9YF20-20		AD45 (DUMP TRUCKS) S/N: BKZ181-UP		AP-1000D (PAVING EQUIPMENT) CAT S/N: EAD1-UP	
Hydraulic Oil Filter.....	H-5526	Hydraulic Oil Filter.....	H-55280	Hydraulic Oil Filter.....	HC-5504
994 (LOADERS) S/N: 9YF21-27		Hydraulic Oil Filter.....	H-5526	Hydraulic Oil Filter.....	H-5517
Hydraulic Oil Filter.....	HC-5504	Hydraulic Oil Filter.....	H-5503	AP-1000D (PAVING EQUIPMENT) CAT S/N: KHX1-UP	
Hydraulic Oil Filter.....	H-5503	Hydraulic Oil Filter.....	H-55270	Hydraulic Oil Filter.....	HC-5504
Hydraulic Oil Filter.....	H-5526	Hydraulic Oil Filter.....	H-5504	Hydraulic Oil Filter.....	H-5517
Hydraulic Oil Filter.....	H-55270	AD55 (DUMP TRUCKS) S/N: ANW1-UP		AP-1050B (PAVING EQUIPMENT) CAT 3116	
Hydraulic Oil Filter.....	HC-5508	Hydraulic Oil Filter.....	HC-5504	Hydraulic Oil Filter.....	H-5517
Hydraulic Oil Filter.....	H-55280	Hydraulic Oil Filter.....	HC-55300	Hydraulic Oil Filter.....	H-5517
994 (LOADERS) S/N: 9YF28-48		Hydraulic Oil Filter.....	HC-5516	AP-1055D (PAVING EQUIPMENT) CAT S/N: A6P1-UP	
Hydraulic Oil Filter.....	H-55280	Hydraulic Oil Filter.....	HC-5512	Hydraulic Oil Filter.....	H-5517
Hydraulic Oil Filter.....	HC-5504	Hydraulic Oil Filter.....	HC-5506	Hydraulic Oil Filter.....	H-57030
Hydraulic Oil Filter.....	H-55270	Hydraulic Oil Filter.....	HC-5503	AP-1055D (PAVING EQUIPMENT) CAT S/N: FAC1-UP	
Hydraulic Oil Filter.....	HC-5508	AE40 (DUMP TRUCKS) S/N: 1ZZ1-UP		Hydraulic Oil Filter.....	H-5517
Hydraulic Oil Filter.....	H-5526	Hydraulic Oil Filter.....	H-55280	Hydraulic Oil Filter.....	HC-5504
994D (LOADERS) CAT 3516B (S/N: 3TZ1-UP)		Hydraulic Oil Filter.....	H-55270	AP-1055D (PAVING EQUIPMENT) CAT S/N: KHX1-UP	
Hydraulic Oil Filter.....	H-55270	Hydraulic Oil Filter.....	H-5504	Hydraulic Oil Filter.....	HC-5504
Hydraulic Oil Filter.....	H-5504	Hydraulic Oil Filter.....	H-5503	Hydraulic Oil Filter.....	H-5517
Hydraulic Oil Filter.....	H-55280	Hydraulic Oil Filter.....	H-5526	AP-1055D (PAVING EQUIPMENT) CAT S/N: 7HN1-253-UP	
Hydraulic Oil Filter.....	H-5526	AE40 SERIES II (DUMP TRUCKS) S/N: BLW181-UP		Hydraulic Oil Filter.....	HC-5504
Hydraulic Oil Filter.....	HC-5504	Hydraulic Oil Filter.....	H-5504	Hydraulic Oil Filter.....	H-5517
994F (DOZERS) CAT S/N: 4421-UP , 2007-UP		Hydraulic Oil Filter.....	H-55270	AP-655C (PAVING EQUIPMENT) S/N: AYP1-UP	
Hydraulic Oil Filter.....	H-55280	Hydraulic Oil Filter.....	H-5526	Hydraulic Oil Filter.....	H-5517
Hydraulic Oil Filter.....	HC-5512	Hydraulic Oil Filter.....	H-55280	Hydraulic Oil Filter.....	HC-5504
Hydraulic Oil Filter.....	H-5526	Hydraulic Oil Filter.....	H-5503	AP-655C (PAVING EQUIPMENT) S/N: CDG1-UP	
Hydraulic Oil Filter.....	HC-5504	AP-1000B (PAVING EQUIPMENT) S/N: 7HN1-253-UP		Hydraulic Oil Filter.....	H-5517
994F (DOZERS) CAT S/N: 8WM1-UP , 2007-UP		Hydraulic Oil Filter.....	H-5517	Hydraulic Oil Filter.....	HC-5504
Hydraulic Oil Filter.....	HC-5504	Hydraulic Oil Filter.....	HC-55220	AP-800C (PAVING EQUIPMENT) S/N: 1PM1-UP	
Hydraulic Oil Filter.....	H-5526	Hydraulic Oil Filter.....	HC-5507	Hydraulic Oil Filter.....	HC-76080
Hydraulic Oil Filter.....	HC-5512	AP-1000B (PAVING EQUIPMENT) S/N: 7HN254-311-UP		Hydraulic Oil Filter.....	HC-5507
Hydraulic Oil Filter.....	H-55280	Hydraulic Oil Filter.....	HC-55220	Hydraulic Oil Filter.....	H-5517
994G (LOADERS) CAT S/N: 7TR1-UP		Hydraulic Oil Filter.....	H-5517	Hydraulic Oil Filter.....	HC-55220
Hydraulic Oil Filter.....	H-5526	AP-1000B (PAVING EQUIPMENT) S/N: 7HN312-UP		AP-800D (PAVING EQUIPMENT) S/N: A5P1-151-UP	
Hydraulic Oil Filter.....	H-55270	Hydraulic Oil Filter.....	HC-55220	Hydraulic Oil Filter.....	HC-5507
Hydraulic Oil Filter.....	H-55280	Hydraulic Oil Filter.....	HC-5507	Hydraulic Oil Filter.....	HC-55220
994G (LOADERS) CAT S/N: 8FR1-UP		Hydraulic Oil Filter.....	H-5517	Hydraulic Oil Filter.....	H-5517
Hydraulic Oil Filter.....	H-55280	AP-1000B (PAVING EQUIPMENT) S/N: AGP1-175-UP		AP-800D (PAVING EQUIPMENT) S/N: A5P152-UP	
Hydraulic Oil Filter.....	H-55270	Hydraulic Oil Filter.....	HC-55220	Hydraulic Oil Filter.....	H-5517
Hydraulic Oil Filter.....	H-5526	Hydraulic Oil Filter.....	H-5517	Hydraulic Oil Filter.....	HC-55220
998A (LOADERS)		Hydraulic Oil Filter.....	HC-5507	Hydraulic Oil Filter.....	HC-5507
Hydraulic Oil Filter.....	H-5503	AP-1000B (PAVING EQUIPMENT) S/N: AGP176-UP		AP-900B (PAVING EQUIPMENT) CAT S/N: 98Z31739-UP	
998B (LOADERS)		Hydraulic Oil Filter.....	HC-5507	Hydraulic Oil Filter.....	H-5517
Hydraulic Oil Filter.....	H-5504	Hydraulic Oil Filter.....	H-5517	Hydraulic Oil Filter.....	HC-55220
		Hydraulic Oil Filter.....	HC-55220	Hydraulic Oil Filter.....	HC-5507



ENGINE APPLICATION

MODEL/APPLICATION	SAKURA NO	MODEL/APPLICATION	SAKURA NO	MODEL/APPLICATION	SAKURA NO
CATERPILLAR		CATERPILLAR		CATERPILLAR	
AP-900B (PAVING EQUIPMENT) CAT S/N: AG31-UP		Hydraulic Oil Filter.....	H-5517	BG-260C (PAVING EQUIPMENT) S/N: BYG205-UP	
Hydraulic Oil Filter.....	HC-55220	BG-2455C (PAVING EQUIPMENT) S/N: ACM253-UP		Hydraulic Oil Filter.....	H-5517
Hydraulic Oil Filter.....	H-5517	Hydraulic Oil Filter.....	HC-5507	Hydraulic Oil Filter.....	HC-55220
Hydraulic Oil Filter.....	HC-5507	Hydraulic Oil Filter.....	HC-55220	Hydraulic Oil Filter.....	HC-5507
BG-2255C (PAVING EQUIPMENT) S/N: B9G1-UP		Hydraulic Oil Filter.....	H-5517	BG-260D (PAVING EQUIPMENT) CAT S/N: BPW1-UP	
Hydraulic Oil Filter.....	HC-5504	BG-2455C (PAVING EQUIPMENT) S/N: B2G1-UP		Hydraulic Oil Filter.....	HC-5504
Hydraulic Oil Filter.....	H-5517	Hydraulic Oil Filter.....	HC-5507	Hydraulic Oil Filter.....	H-5517
BG-2255C (PAVING EQUIPMENT) S/N: CKR1-UP		Hydraulic Oil Filter.....	H-5517	BG-260D (PAVING EQUIPMENT) CAT S/N: KHX1-UP	
Hydraulic Oil Filter.....	H-5517	Hydraulic Oil Filter.....	HC-55220	Hydraulic Oil Filter.....	H-5517
Hydraulic Oil Filter.....	HC-5504	BG-2455D (PAVING EQUIPMENT) CAT S/N: BNN1-UP		Hydraulic Oil Filter.....	HC-5504
BG-225C (PAVING EQUIPMENT) S/N: 5GN1-503-UP		Hydraulic Oil Filter.....	HC-5504	BG-230D (PAVING EQUIPMENT) CAT S/N: B4G1-UP	
Hydraulic Oil Filter.....	HC-5507	Hydraulic Oil Filter.....	H-5517	Hydraulic Oil Filter.....	H-5517
Hydraulic Oil Filter.....	HC-55220	BG-2455D (PAVING EQUIPMENT) CAT S/N: BXW1-UP		Hydraulic Oil Filter.....	HC-55220
Hydraulic Oil Filter.....	H-5517	Hydraulic Oil Filter.....	H-5517	Hydraulic Oil Filter.....	HC-5507
BG-225C (PAVING EQUIPMENT) S/N: 5GN1-504-UP		Hydraulic Oil Filter.....	HC-5504	BG-230D (PAVING EQUIPMENT) CAT S/N: CRS1-UP	
Hydraulic Oil Filter.....	HC-5507	BG-2455D (PAVING EQUIPMENT) CAT S/N: KHX1-UP		Hydraulic Oil Filter.....	H-5517
Hydraulic Oil Filter.....	H-5517	Hydraulic Oil Filter.....	HC-5504	Hydraulic Oil Filter.....	HC-55220
Hydraulic Oil Filter.....	HC-55220	Hydraulic Oil Filter.....	H-5517	Hydraulic Oil Filter.....	HC-5507
BG-225C (PAVING EQUIPMENT) S/N: B6G1-UP		BG-245C (PAVING EQUIPMENT) S/N: 4XN1-109-UP		CB-214C (PAVING EQUIPMENT) S/N: 9XK00826-UP	
Hydraulic Oil Filter.....	HC-55220	Hydraulic Oil Filter.....	HC-55220	Hydraulic Oil Filter.....	HC-5504
Hydraulic Oil Filter.....	H-5517	Hydraulic Oil Filter.....	HC-5507	CB-214C (PAVING EQUIPMENT) S/N: 9XK1-UP	
Hydraulic Oil Filter.....	HC-5507	Hydraulic Oil Filter.....	H-5517	Hydraulic Oil Filter.....	HC-5504
BG-230 (PAVING EQUIPMENT) S/N: 9AL1-UP		BG-245C (PAVING EQUIPMENT) S/N: 4XN110-UP		CB-214D (PAVING EQUIPMENT) CAT S/N: 1T21-UP , 2007-UP	
Hydraulic Oil Filter.....	H-5517	Hydraulic Oil Filter.....	H-5517	Hydraulic Oil Filter.....	HC-55220
Hydraulic Oil Filter.....	HC-55220	Hydraulic Oil Filter.....	HC-55220	Hydraulic Oil Filter.....	HC-5507
Hydraulic Oil Filter.....	HC-76080	Hydraulic Oil Filter.....	HC-5507	CB-214D (PAVING EQUIPMENT) CAT S/N: 4ZW1-UP , 2007-UP	
Hydraulic Oil Filter.....	HC-5507	BG-260C (PAVING EQUIPMENT) S/N: 8GN1-547-UP		Hydraulic Oil Filter.....	HC-5507
BG-240C (PAVING EQUIPMENT) CAT S/N: 98Z31739-UP		Hydraulic Oil Filter.....	H-5517	CB-224D (COMPACTORS) CAT 3013 (S/N: 8RZ1-UP)	
Hydraulic Oil Filter.....	HC-55220	Hydraulic Oil Filter.....	HC-55220	Hydraulic Oil Filter.....	HC-5507
Hydraulic Oil Filter.....	HC-5507	Hydraulic Oil Filter.....	HC-5507	CB-225D (PAVING EQUIPMENT) CAT S/N: 4ZW1-UP	
Hydraulic Oil Filter.....	H-5517	BG-260C (PAVING EQUIPMENT) S/N: 8GN548-576-UP		Hydraulic Oil Filter.....	HC-5507
BG-240C (PAVING EQUIPMENT) CAT S/N: AGL1-UP		Hydraulic Oil Filter.....	H-5517	CB-225D (PAVING EQUIPMENT) CAT S/N: 9FZ1-UP	
Hydraulic Oil Filter.....	H-5517	Hydraulic Oil Filter.....	HC-55220	Hydraulic Oil Filter.....	HC-5507
Hydraulic Oil Filter.....	HC-55220	Hydraulic Oil Filter.....	HC-5507	CB214E (COMPACTORS) CAT 3013C (S/N: 2141-UP)	
Hydraulic Oil Filter.....	HC-5507	BG-260C (PAVING EQUIPMENT) S/N: 8GN577-UP		Hydraulic Oil Filter.....	HC-5507
BG-2455C (PAVING EQUIPMENT) S/N: 6TN1-UP		Hydraulic Oil Filter.....	HC-55220	CB224E (COMPACTORS) CAT 3013C (S/N: 2241-UP)	
Hydraulic Oil Filter.....	HC-5507	Hydraulic Oil Filter.....	H-5517	Hydraulic Oil Filter.....	HC-5507
Hydraulic Oil Filter.....	HC-55220	Hydraulic Oil Filter.....	HC-5507	CB224E (COMPACTORS) CAT 3013C (S/N: 2241-UP)	
Hydraulic Oil Filter.....	H-5517	BG-260C (PAVING EQUIPMENT) S/N: BYG1-UP		Hydraulic Oil Filter.....	HC-5507
BG-2455C (PAVING EQUIPMENT) S/N: ACM1-252-UP		Hydraulic Oil Filter.....	H-5517	CB224E (COMPACTORS) CAT 3013C (S/N: 2241-UP)	
Hydraulic Oil Filter.....	HC-5507	Hydraulic Oil Filter.....	HC-5507	Hydraulic Oil Filter.....	HC-5507
Hydraulic Oil Filter.....	HC-55220	Hydraulic Oil Filter.....	HC-55220		



ENGINE APPLICATION

MODEL/APPLICATION	SAKURA NO	MODEL/APPLICATION	SAKURA NO	MODEL/APPLICATION	SAKURA NO
CATERPILLAR		CATERPILLAR		CATERPILLAR	
CHALLENGER 65 (TRACTORS) S/N: 7YC1-1116		CHALLENGER 45 (TRACTORS) CAT 3116 (S/N: 1DR205-1DR1105)		CP-323D (PAVING EQUIPMENT) S/N: EAS1-UP	
Hydraulic Oil Filter.....	HC-5508	Hydraulic Oil Filter.....	HC-5506	Hydraulic Oil Filter.....	HC-5504
CHALLENGER 65 (TRACTORS) S/N: 7YC1117-1899		Hydraulic Oil Filter.....	HC-5504	CP-533D (PAVING EQUIPMENT) S/N: 6AZ1-UP	
Hydraulic Oil Filter.....	HC-5503	CHALLENGER 65C (TRACTORS) S/N: 2ZJ1-1679		Hydraulic Oil Filter.....	HC-5504
CHALLENGER 65B (TRACTORS) CAT 3306		Hydraulic Oil Filter.....	HC-5503	CP-533D (PAVING EQUIPMENT) S/N: AFC1-UP	
Hydraulic Oil Filter.....	HC-5506	CHALLENGER 670 (TRACTORS)		Hydraulic Oil Filter.....	HC-5504
Hydraulic Oil Filter.....	HC-5503	Hydraulic Oil Filter Full Flow.....	HC-79331	CP-533E (PAVING EQUIPMENT) S/N: ASM1-UP	
Hydraulic Oil Filter.....	HC-5508	CHALLENGER 75B (TRACTORS) CAT 3176		Hydraulic Oil Filter.....	HC-5504
CHALLENGER 65B (TRACTORS) S/N: 7YC1900-UP		Hydraulic Oil Filter.....	HC-5508	CP-533E (PAVING EQUIPMENT) S/N: BZG1-UP	
Hydraulic Oil Filter.....	HC-5503	Hydraulic Oil Filter.....	HC-5503	Hydraulic Oil Filter.....	HC-5504
CHALLENGER 70C (TRACTORS) CAT 3306TA (S/N: 2YL1-UP)		Hydraulic Oil Filter.....	HC-5511	CP-533E (PAVING EQUIPMENT) S/N: DAM1-UP	
Hydraulic Oil Filter.....	HC-5503	CHALLENGER 75B (TRACTORS) CAT 3176 (S/N: 4CJ1-UP)		Hydraulic Oil Filter.....	HC-5504
CHALLENGER 75 (TRACTORS) CAT 3176 (S/N: 4CJ1-UP)		Hydraulic Oil Filter.....	HC-5508	CP-563 (PAVING EQUIPMENT) S/N: 1YJ1-UP	
Hydraulic Oil Filter.....	HC-5503	Hydraulic Oil Filter.....	HC-5503	Hydraulic Oil Filter.....	HC-5504
Hydraulic Oil Filter.....	HC-5508	CHALLENGER 75C (TRACTORS) CAT 3176 (S/N: 4KK1-4KK1849)		CP-563 (PAVING EQUIPMENT) S/N: 8XF1-650	
CHALLENGER 85C (TRACTORS) CAT 3176 (S/N: 9TK1-1399)		Hydraulic Oil Filter.....	HC-5503	Hydraulic Oil Filter.....	H-7916
Hydraulic Oil Filter.....	HC-5503	Hydraulic Oil Filter.....	HC-5508	CP-563C (PAVING EQUIPMENT) S/N: 5JN1-UP	
CHALLENGER 85C (TRACTORS) CAT 3176 (S/N: 9TK1400-UP)		CHALLENGER 75C (TRACTORS) CAT 3176 (S/N: 4KK1850-UP)		Hydraulic Oil Filter.....	HC-5504
Hydraulic Oil Filter.....	HC-5503	Hydraulic Oil Filter.....	HC-5503	CP-563E (COMPACTORS) S/N: ASY1-UP	
CHALLENGER 35 (TRACTORS) CAT 3116 (Excluding S/N: 550, 557, 558, 567)		Hydraulic Oil Filter.....	HC-5508	Hydraulic Oil Filter.....	HC-5504
Hydraulic Oil Filter.....	HC-5506	CHALLENGER 85D (TRACTORS) CAT 3196 (S/N: 4GR1-UP)		CP-563E (COMPACTORS) S/N: ASZ1-UP	
CHALLENGER 35 (TRACTORS) CAT 3116 (S/N: 8DN1-204)		Hydraulic Oil Filter.....	HC-5503	Hydraulic Oil Filter.....	HC-5504
Hydraulic Oil Filter.....	HC-5506	CHALLENGER 85E (TRACTORS) CAT 3196		CP-563E (COMPACTORS) S/N: BWE1-UP	
Hydraulic Oil Filter.....	HC-5504	Hydraulic Oil Filter.....	HC-5503	Hydraulic Oil Filter.....	HC-5504
CHALLENGER 35 (TRACTORS) CAT 3116 (S/N: 8DN205-548)		Hydraulic Oil Filter.....	HC-5506	CP-563E (COMPACTORS) S/N: CNT1-UP	
Hydraulic Oil Filter.....	HC-5504	CHALLENGER MT265 (TRACTORS)		Hydraulic Oil Filter.....	HC-5504
Hydraulic Oil Filter.....	HC-5506	Hydraulic Oil Filter.....	HC-7940	CP-563E (COMPACTORS) S/N: 7BD1-UP	
CHALLENGER 35 (TRACTORS) CAT 3116 (S/N: 8DN549-UP)		CHALLENGER MT285 (TRACTORS)		Hydraulic Oil Filter.....	HC-69031
Hydraulic Oil Filter.....	HC-5506	Hydraulic Oil Filter.....	HC-7940	CP553 (PAVING EQUIPMENT) S/N: 8CD1-UP	
CHALLENGER 36 (TRACTORS) S/N: 8DN205-548		CHALLENGER MT635 (TRACTORS) SISU C8.4L		Hydraulic Oil Filter.....	HC-69031
Hydraulic Oil Filter.....	HC-5506	Hydraulic Oil Filter.....	H-5001	CP-563D (PAVING EQUIPMENT) S/N: 5LZ1-UP	
Hydraulic Oil Filter.....	HC-5504	CHALLENGER MT655 (TRACTORS) SISU C8.4L		Hydraulic Oil Filter.....	HC-5504
CHALLENGER 45 (TRACTORS) CAT 3116 (Excluding S/N: 1117, 1122, 1124,1126)		Hydraulic Oil Filter.....	H-5001	CP-563D (PAVING EQUIPMENT) S/N: 9ZW1-122-UP	
Hydraulic Oil Filter.....	HC-5506	CHALLENGER MT745 (TRACTORS)		Hydraulic Oil Filter.....	HC-5504
CHALLENGER 45 (TRACTORS) CAT 3116 (S/N: 1DR1106-UP)		Hydraulic Oil Filter.....	HC-5504	CP-563D (PAVING EQUIPMENT) S/N: 9ZW1-122-UP	
Hydraulic Oil Filter.....	HC-5506	CP-323C (COMPACTORS) CAT 3054 (S/N: EAS1-UP)		Hydraulic Oil Filter.....	HC-5504
		Hydraulic Oil Filter.....	HC-5504		



ENGINE APPLICATION

MODEL/APPLICATION	SAKURA NO	MODEL/APPLICATION	SAKURA NO	MODEL/APPLICATION	SAKURA NO
CATERPILLAR		CATERPILLAR		CATERPILLAR	
CP-563D (PAVING EQUIPMENT) S/N: 9ZW123-581-UP		CS563 (PAVING EQUIPMENT) S/N: 8XF651-UP		CS-563D (PAVING EQUIPMENT) S/N: 1SZ1-20404-UP	
Hydraulic Oil Filter.....	HC-5504	Hydraulic Oil Filter.....	HC-5504	Hydraulic Oil Filter.....	HC-5504
CP-563D (PAVING EQUIPMENT) S/N: 9ZW582-UP		CS-531C (PAVING EQUIPMENT) S/N: 5ZN1-171-UP		CS-563D (PAVING EQUIPMENT) S/N: 1SZ20405-UP	
Hydraulic Oil Filter.....	HC-5504	Hydraulic Oil Filter.....	HC-5504	Hydraulic Oil Filter.....	HC-5504
CP-663E (COMPACTORS) CAT 3056 (S/N: ASF1-UP)		CS-531C (PAVING EQUIPMENT) S/N: 5ZN172-UP		CS-563D (PAVING EQUIPMENT) S/N: 2RZ1-UP	
Hydraulic Oil Filter.....	HC-5504	Hydraulic Oil Filter.....	HC-5504	Hydraulic Oil Filter.....	HC-5504
CP-663E (COMPACTORS) CAT 3056 (S/N: DAF1-UP)		CS-531C (PAVING EQUIPMENT) S/N: 9RN1-UP		CS-563D (PAVING EQUIPMENT) S/N: 9MW1-144-UP	
Hydraulic Oil Filter.....	HC-5504	Hydraulic Oil Filter.....	HC-5504	Hydraulic Oil Filter.....	HC-5504
CS-323C (COMPACTORS) CAT 3054 (S/N: DAR1-UP)		CS-531D (PAVING EQUIPMENT) S/N: 4MZ1-UP		CS-563D (PAVING EQUIPMENT) S/N: 9MW145-979-UP	
Hydraulic Oil Filter.....	HC-5504	Hydraulic Oil Filter.....	HC-5504	Hydraulic Oil Filter.....	HC-5504
CS-323D (PAVING EQUIPMENT) S/N: DAR1-UP		CS-531D (PAVING EQUIPMENT) S/N: AGH1-UP		CS-563D (PAVING EQUIPMENT) S/N: 9MW980-UP	
Hydraulic Oil Filter.....	HC-5504	Hydraulic Oil Filter.....	HC-5504	Hydraulic Oil Filter.....	HC-5504
CS-423E (COMPACTORS) CAT 3054B (S/N: ASH1-UP)		CS-533C (EXCAVATORS) S/N: 2WN1-183-UP		CS-563E (COMPACTORS) CAT 3056E (S/N: ASA1-UP)	
Hydraulic Oil Filter.....	HC-5504	Hydraulic Oil Filter.....	HC-5504	Hydraulic Oil Filter.....	HC-5504
CS-423E (COMPACTORS) CAT 3054B (S/N: DCL1-UP)		CS-533C (PAVING EQUIPMENT) S/N: 2WN184-UP		CS-563E (COMPACTORS) CAT 3056E (S/N: CNG1-UP)	
Hydraulic Oil Filter.....	HC-5504	Hydraulic Oil Filter.....	HC-5504	Hydraulic Oil Filter.....	HC-5504
CS-431C (PAVING EQUIPMENT) S/N: 3WZ1-UP		CS-533C (PAVING EQUIPMENT) S/N: 2XN1-458-UP		CS-573C (PAVING EQUIPMENT) S/N: 6LN1-69-UP	
Hydraulic Oil Filter.....	HC-5504	Hydraulic Oil Filter.....	HC-5504	Hydraulic Oil Filter.....	HC-5504
CS-431C (PAVING EQUIPMENT) S/N: 9XL1-UP		CS-533C (PAVING EQUIPMENT) S/N: 2XN459-459-UP		CS-573C (PAVING EQUIPMENT) S/N: 6LN70-83-UP	
Hydraulic Oil Filter.....	HC-5504	Hydraulic Oil Filter.....	HC-5504	Hydraulic Oil Filter.....	HC-5504
CS-431C (PAVING EQUIPMENT) S/N: 9XL204-UP		CS-533C (PAVING EQUIPMENT) S/N: 2XN460-490-UP		CS-573C (PAVING EQUIPMENT) S/N: 6LN84-UP	
Hydraulic Oil Filter.....	HC-5504	Hydraulic Oil Filter.....	HC-5504	Hydraulic Oil Filter.....	HC-5504
CS-431C (PAVING EQUIPMENT) S/N: GEN1-UP		CS-533C (PAVING EQUIPMENT) S/N: 2XN491-UP		CS-573E (COMPACTORS) CAT 3056E (S/N: CEB1-UP)	
Hydraulic Oil Filter.....	HC-5504	Hydraulic Oil Filter.....	HC-5504	Hydraulic Oil Filter.....	HC-5504
CS-433E (COMPACTORS) CAT 3054 (S/N: DAC1-UP)		CS-533D (PAVING EQUIPMENT) S/N: 5CZ1-UP		CS-573E (COMPACTORS) CAT 3056E (S/N: CNN1-UP)	
Hydraulic Oil Filter.....	HC-5504	Hydraulic Oil Filter.....	HC-5504	Hydraulic Oil Filter.....	HC-5504
CS433 (PAVING EQUIPMENT) S/N: 2JM1-UP		CS-533D (PAVING EQUIPMENT) S/N: AET1-UP		CS-583C (PAVING EQUIPMENT)	
Hydraulic Oil Filter.....	HC-5504	Hydraulic Oil Filter.....	HC-5504	Hydraulic Oil Filter.....	HC-5504
CS433 (PAVING EQUIPMENT) S/N: 3TM1-UP		CS-533E (COMPACTORS) CAT 3116 (S/N: ASL1-UP)		CS-583D (PAVING EQUIPMENT) S/N: 2CZ1-131-UP	
Hydraulic Oil Filter.....	HC-5504	Hydraulic Oil Filter.....	HC-5504	Hydraulic Oil Filter.....	HC-5504
CS563 (PAVING EQUIPMENT) S/N: 7GG1-UP		CS-533E (COMPACTORS) CAT 3116 (S/N: DAK1-UP)		CS-583D (PAVING EQUIPMENT) S/N: 2CZ132-182-UP	
Hydraulic Oil Filter.....	H-7916	Hydraulic Oil Filter.....	HC-5504	Hydraulic Oil Filter.....	HC-5504
CS563 (PAVING EQUIPMENT) S/N: 8XF1-UP		CS-563C (PAVING EQUIPMENT) S/N: 4KN1-UP		CS-583D (PAVING EQUIPMENT) S/N: 2CZ183-UP	
Hydraulic Oil Filter.....	H-7916	Hydraulic Oil Filter.....	HC-5504	Hydraulic Oil Filter.....	HC-5504



ENGINE APPLICATION

MODEL/APPLICATION	SAKURA NO	MODEL/APPLICATION	SAKURA NO	MODEL/APPLICATION	SAKURA NO
CATERPILLAR		CATERPILLAR		CATERPILLAR	
CS-583D (PAVING EQUIPMENT) S/N: 3GZ1-UP		Hydraulic Oil Filter.....	H-5506	Hydraulic Oil Filter.....	HC-5504
	HC-5504	CS-643 (PAVING EQUIPMENT) CAT S/N: 7JD1-UP		Hydraulic Oil Filter.....	H-5510
CS551 (PAVING EQUIPMENT) S/N: 6ZD1-UP		Hydraulic Oil Filter.....	H-5506	Hydraulic Oil Filter.....	H-55270
	HC-69031	Hydraulic Oil Filter.....	H-5504	D10R (DOZERS) CAT (S/N: 9EA1-UP)	
CS553 (PAVING EQUIPMENT) S/N: 7AD1-UP		CS-663E (COMPACTORS) CAT 3056 (S/N: ASB1-UP)		Hydraulic Oil Filter.....	H-5501
	HC-69031	Hydraulic Oil Filter.....	HC-5504	D10R (DOZERS) CAT 3412 (S/N: 3KR1-UP)	
CS553 (PAVING EQUIPMENT) S/N: 7BD1-UP		CS-663E (COMPACTORS) CAT 3056 (S/N: DAG1-UP)		Hydraulic Oil Filter.....	H-5510
	HC-69031	Hydraulic Oil Filter.....	HC-5504	Hydraulic Oil Filter.....	H-5526
CS553 (PAVING EQUIPMENT) S/N: 8BD1-UP		CS-683E (COMPACTORS) CAT 3056 (S/N: ASG1-UP)		Hydraulic Oil Filter.....	H-5501
	HC-69031	Hydraulic Oil Filter.....	HC-5504	Hydraulic Oil Filter.....	H-55280
CS573 (PAVING EQUIPMENT) S/N: 8PK1-UP		CS-683E (COMPACTORS) CAT 3056 (S/N: DAD1-UP)		D10R (DOZERS) CAT 3412E (S/N: 3KR1-UP)	
	HC-5504	Hydraulic Oil Filter.....	HC-5504	Hydraulic Oil Filter.....	H-5526
CS-573D (PAVING EQUIPMENT) S/N: 2YZ1-UP		D10 (DOZERS) S/N: 76X1-358		Hydraulic Oil Filter.....	H-5510
	HC-5504	Hydraulic Oil Filter.....	H-5503	D10R (DOZERS) CAT 3412E (S/N: AKT1-UP)	
CS-573D (PAVING EQUIPMENT) S/N: CMK1-197-UP		D10 (DOZERS) S/N: 76X359-UP		Hydraulic Oil Filter.....	H-5001
	HC-5504	Hydraulic Oil Filter.....	H-5503	Hydraulic Oil Filter.....	H-5526
CS-573D (PAVING EQUIPMENT) S/N: CMK198-UP		D10 (DOZERS) S/N: 84W1-609		Hydraulic Oil Filter.....	H-5510
	HC-5504	Hydraulic Oil Filter.....	H-5503	Hydraulic Oil Filter.....	H-55280
CS583 (PAVING EQUIPMENT) S/N: 8YJ1-UP		D10 (DOZERS) S/N: 84W610-640		D10R (DOZERS) S/N: 3KR1463-UP	
	HC-5504	Hydraulic Oil Filter.....	H-5503	Hydraulic Oil Filter.....	H-55270
CS583E (COMPACTORS) CAT 3056E (S/N: CNX1-UP) , 2004-UP		D10 (DOZERS) S/N: 84W641-645		Hydraulic Oil Filter.....	H-55280
	HC-5504	Hydraulic Oil Filter.....	H-5503	Hydraulic Oil Filter.....	HC-5504
CS583E (COMPACTORS) CAT 3056E (S/N: DAJ1-UP)		D10 (DOZERS) S/N: 84W646-UP		Hydraulic Oil Filter.....	H-5526
	HC-5504	Hydraulic Oil Filter.....	H-5503	Hydraulic Oil Filter.....	H-5510
CS-643 (PAVING EQUIPMENT) CAT S/N: 12Z1-UP		D10T (CRAWLERS) CAT C27 , 2006-UP		Hydraulic Oil Filter.....	HC-5504
	H-5506	Hydraulic Oil Filter.....	HC-5516	D10R (DOZERS) S/N: 3KR620-1462	
	H-5504	Hydraulic Oil Filter.....	H-5510	Hydraulic Oil Filter.....	HC-5504
CS-643 (PAVING EQUIPMENT) CAT S/N: 7FD1-UP		D10N (DOZERS) S/N: 2YD1-UP		Hydraulic Oil Filter.....	H-5510
	H-5504	Hydraulic Oil Filter.....	H-5504	Hydraulic Oil Filter.....	H-55270
	H-5506	Hydraulic Oil Filter.....	H-55270	Hydraulic Oil Filter.....	H-5526
CS-643 (PAVING EQUIPMENT) CAT S/N: 7GD1-UP		Hydraulic Oil Filter.....	H-5509	Hydraulic Oil Filter.....	H-55280
	H-5504	Hydraulic Oil Filter.....	H-5510	D11N (DOZERS) S/N: 4HK1-UP	
	H-5506	Hydraulic Oil Filter.....	H-5510	Hydraulic Oil Filter.....	H-5509
CS-643 (PAVING EQUIPMENT) CAT S/N: 7HD1-UP		D10N (DOZERS) S/N: 3SK1-UP		Hydraulic Oil Filter.....	H-5526
	H-5504	Hydraulic Oil Filter.....	H-55270	Hydraulic Oil Filter.....	H-5503
	H-5506	Hydraulic Oil Filter.....	H-5504	Hydraulic Oil Filter.....	H-55280
	H-5504	Hydraulic Oil Filter.....	H-5510	D11N (DOZERS) S/N: 4HX1-UP	
	H-5504	Hydraulic Oil Filter.....	H-5510	Hydraulic Oil Filter.....	H-5503



ENGINE APPLICATION

MODEL/APPLICATION	SAKURA NO	MODEL/APPLICATION	SAKURA NO	MODEL/APPLICATION	SAKURA NO
CATERPILLAR		CATERPILLAR		CATERPILLAR	
D11N (DOZERS) S/N: 74Z1-UP		Hydraulic Oil Filter.....	H-55270	D25C (CONSTRUCTION & MINING) CAT 3306 (S/N: 9YC1-1011) , 2005-UP	
Hydraulic Oil Filter.....	H-5509	Hydraulic Oil Filter.....	H-55280	Hydraulic Oil Filter.....	H-5503
Hydraulic Oil Filter.....	H-5526	Hydraulic Oil Filter.....	H-5001	Hydraulic Oil Filter.....	H-5504
Hydraulic Oil Filter.....	H-5503	D20D (CONSTRUCTION & MINING) CAT 3116 (S/N: 6NG1-UP) , 2005-UP		D25C (DUMP TRUCKS) S/N: 9YC1-1011	
Hydraulic Oil Filter.....	H-55280	Hydraulic Oil Filter.....	H-5504	Hydraulic Oil Filter.....	H-5504
D11R (DOZERS) CAT 3508 (S/N: 7PZ1-UP)		Hydraulic Oil Filter.....	H-5503	Hydraulic Oil Filter.....	H-5503
Hydraulic Oil Filter.....	H-5001	D20D (CONSTRUCTION & MINING) CAT 3116 (S/N: 9MG1-UP) , 2005-UP		Hydraulic Oil Filter.....	H-55270
Hydraulic Oil Filter.....	H-5526	Hydraulic Oil Filter.....	H-5504	Hydraulic Oil Filter.....	H-5526
D11R (DOZERS) CAT 3508 (S/N: 8ZR1-UP)		Hydraulic Oil Filter.....	H-5503	Hydraulic Oil Filter.....	H-55280
Hydraulic Oil Filter.....	H-5509	D20D (DUMP TRUCKS) S/N: 6NG1-UP		D25D (CONSTRUCTION & MINING) CAT 3306 (S/N: 1HK-UP) , 2005-UP	
Hydraulic Oil Filter.....	H-5526	Hydraulic Oil Filter.....	H-55280	Hydraulic Oil Filter.....	H-5503
D11R (DOZERS) CAT 3508 (S/N: 9TR1-UP)		Hydraulic Oil Filter.....	H-5503	Hydraulic Oil Filter.....	H-5504
Hydraulic Oil Filter.....	H-5509	Hydraulic Oil Filter.....	H-5504	D25D (DUMP TRUCKS) S/N: 1HK1-673	
Hydraulic Oil Filter.....	H-5526	Hydraulic Oil Filter.....	H-55270	Hydraulic Oil Filter.....	H-5526
D11R (DOZERS) CAT 3508 (S/N: 9XR1-UP)		Hydraulic Oil Filter.....	H-5526	Hydraulic Oil Filter.....	H-5504
Hydraulic Oil Filter.....	H-5526	Hydraulic Oil Filter.....	H-55270	Hydraulic Oil Filter.....	H-5503
D11R (DOZERS) CAT 3508 (S/N: 9XR1-UP)		Hydraulic Oil Filter.....	H-55270	Hydraulic Oil Filter.....	H-55280
Hydraulic Oil Filter.....	H-5526	Hydraulic Oil Filter.....	H-5504	Hydraulic Oil Filter.....	H-55270
Hydraulic Oil Filter.....	H-5001	Hydraulic Oil Filter.....	H-5503	D25D (DUMP TRUCKS) S/N: 1HK674-UP	
D11R (DOZERS) CAT 3508 (S/N: AAF1-UP)		Hydraulic Oil Filter.....	H-5504	Hydraulic Oil Filter.....	H-5526
Hydraulic Oil Filter.....	H-5526	D22 (DUMP TRUCKS) S/N: 9VA1-UP		Hydraulic Oil Filter.....	H-55270
Hydraulic Oil Filter.....	H-5001	Hydraulic Oil Filter.....	H-5503	Hydraulic Oil Filter.....	H-5504
D11R (DOZERS) S/N: 7PZ289-681-UP		Hydraulic Oil Filter.....	H-5504	Hydraulic Oil Filter.....	H-5503
Hydraulic Oil Filter.....	H-55270	Hydraulic Oil Filter.....	H-5504	Hydraulic Oil Filter.....	H-55280
Hydraulic Oil Filter.....	H-5001	D250E (CONSTRUCTION & MINING) CAT 3306 (S/N: 5TN1-UP) , 2005-UP		D25D (DUMP TRUCKS) S/N: 3AJ1-414	
Hydraulic Oil Filter.....	H-55280	Hydraulic Oil Filter.....	H-5503	Hydraulic Oil Filter.....	H-5504
Hydraulic Oil Filter.....	H-5526	Hydraulic Oil Filter.....	H-5504	Hydraulic Oil Filter.....	H-55280
D11R (DOZERS) S/N: 7PZ682-717-UP		Hydraulic Oil Filter.....	H-5503	Hydraulic Oil Filter.....	H-5503
Hydraulic Oil Filter.....	H-55280	D250E (DUMP TRUCKS) S/N: 4PS1-UP		Hydraulic Oil Filter.....	H-55270
Hydraulic Oil Filter.....	H-5526	Hydraulic Oil Filter.....	H-5503	Hydraulic Oil Filter.....	H-5526
Hydraulic Oil Filter.....	H-55270	Hydraulic Oil Filter.....	H-5526	D25D (DUMP TRUCKS) S/N: 3AJ415-UP	
Hydraulic Oil Filter.....	H-5001	Hydraulic Oil Filter.....	H-55280	Hydraulic Oil Filter.....	H-5526
D11R (DOZERS) S/N: 7PZ718-UP		Hydraulic Oil Filter.....	H-5504	Hydraulic Oil Filter.....	H-5504
Hydraulic Oil Filter.....	H-5526	Hydraulic Oil Filter.....	H-5504	Hydraulic Oil Filter.....	H-5503
Hydraulic Oil Filter.....	H-5001	Hydraulic Oil Filter.....	H-55270	Hydraulic Oil Filter.....	H-55270
Hydraulic Oil Filter.....	H-55270	Hydraulic Oil Filter.....	H-55280	Hydraulic Oil Filter.....	H-55280
Hydraulic Oil Filter.....	H-55280	D250E II (CONSTRUCTION & MINING) CAT 3116 (S/N: 4PS1-UP) , 2005-UP		D25D (DUMP TRUCKS) S/N: 9RF1-UP	
D11R (DOZERS) S/N: AAF1-132-UP		Hydraulic Oil Filter.....	H-5503	Hydraulic Oil Filter.....	H-5504
Hydraulic Oil Filter.....	H-5526	Hydraulic Oil Filter.....	H-55270	Hydraulic Oil Filter.....	H-5503
Hydraulic Oil Filter.....	H-5001	Hydraulic Oil Filter.....	H-55280	Hydraulic Oil Filter.....	H-55270
Hydraulic Oil Filter.....	H-55270	Hydraulic Oil Filter.....	H-5504	Hydraulic Oil Filter.....	H-55280
Hydraulic Oil Filter.....	H-55280	Hydraulic Oil Filter.....	H-5526	D250 (DUMP TRUCKS) S/N: 9VA1-UP	
D11R (DOZERS) S/N: AAF437-UP		D250E II (CONSTRUCTION & MINING) CAT 3306 (S/N: 4PS1-UP) , 2005-UP		Hydraulic Oil Filter.....	H-5504
Hydraulic Oil Filter.....	H-5526	Hydraulic Oil Filter.....	H-5503	Hydraulic Oil Filter.....	H-5503
Hydraulic Oil Filter.....	H-55270	Hydraulic Oil Filter.....	H-5504		
Hydraulic Oil Filter.....	H-5001				
Hydraulic Oil Filter.....	H-55280				



ENGINE APPLICATION

MODEL/APPLICATION	SAKURA NO	MODEL/APPLICATION	SAKURA NO	MODEL/APPLICATION	SAKURA NO
CATERPILLAR		CATERPILLAR		CATERPILLAR	
D250B (CONSTRUCTION & MINING) CAT 3306 (S/N: 5WD1-550) , 2005-UP Hydraulic Oil Filter..... H-5503 Hydraulic Oil Filter..... H-5504		D300E (DUMP TRUCKS) S/N: 5KS1-UP Hydraulic Oil Filter..... H-55270 Hydraulic Oil Filter..... H-5503 Hydraulic Oil Filter..... H-5526 Hydraulic Oil Filter..... H-5504 Hydraulic Oil Filter..... H-55280		D30D (DUMP TRUCKS) S/N: 3AJ415-UP Hydraulic Oil Filter..... H-5526 Hydraulic Oil Filter..... H-5504 Hydraulic Oil Filter..... H-5503 Hydraulic Oil Filter..... H-55270 Hydraulic Oil Filter..... H-55280	
D250B (DUMP TRUCKS) S/N: 5WD1-550 Hydraulic Oil Filter..... H-55280 Hydraulic Oil Filter..... H-5504 Hydraulic Oil Filter..... H-5503 Hydraulic Oil Filter..... H-55270 Hydraulic Oil Filter..... H-5526		D300E (DUMP TRUCKS) S/N: 7FN1-UP Hydraulic Oil Filter..... H-5504 Hydraulic Oil Filter..... H-5503 Hydraulic Oil Filter..... H-5526 Hydraulic Oil Filter..... H-55280 Hydraulic Oil Filter..... H-55270		D30D (DUMP TRUCKS) S/N: 9RF1-UP Hydraulic Oil Filter..... H-55270 Hydraulic Oil Filter..... H-5504 Hydraulic Oil Filter..... H-55280 Hydraulic Oil Filter..... H-5526 Hydraulic Oil Filter..... H-5503	
D250D (CONSTRUCTION & MINING) CAT 3116 (S/N: 6NG1-UP) , 2005-UP Hydraulic Oil Filter..... H-5503 Hydraulic Oil Filter..... H-5504		D300E II (CONSTRUCTION & MINING) CAT 3306 (S/N: 5KS1-UP) , 2005-UP Hydraulic Oil Filter..... H-5503 Hydraulic Oil Filter..... H-5504		D3 (DOZERS) S/N: 27Y-UP Hydraulic Oil Filter..... H-5503	
D250D (CONSTRUCTION & MINING) CAT 3116 (S/N: 9MG1-UP) , 2005-UP Hydraulic Oil Filter..... H-5504 Hydraulic Oil Filter..... H-5503		D30C (CONSTRUCTION & MINING) CAT 3306 (S/N: 7ZC1-257) , 2005-UP Hydraulic Oil Filter..... H-5503 Hydraulic Oil Filter..... H-5504		D3 (TRACTORS) S/N: 6N1-UP Hydraulic Oil Filter..... H-5504	
D250D (DUMP TRUCKS) S/N: 6NG1-UP Hydraulic Oil Filter..... H-5526 Hydraulic Oil Filter..... H-55270 Hydraulic Oil Filter..... H-5504 Hydraulic Oil Filter..... H-55280 Hydraulic Oil Filter..... H-5503		D30C (CONSTRUCTION & MINING) CAT 3306 (S/N: 7ZC1-257) , 2005-UP Hydraulic Oil Filter..... H-5503 Hydraulic Oil Filter..... H-5504		D3 (TRACTORS) S/N: 79U1-UP Hydraulic Oil Filter..... H-5504	
D250D (DUMP TRUCKS) S/N: 9MG1-UP Hydraulic Oil Filter..... H-5503 Hydraulic Oil Filter..... H-5504 Hydraulic Oil Filter..... H-55270 Hydraulic Oil Filter..... H-55280 Hydraulic Oil Filter..... H-5526		D30C (DUMP TRUCKS) S/N: 7ZC1-257 Hydraulic Oil Filter..... H-55280 Hydraulic Oil Filter..... H-55270 Hydraulic Oil Filter..... H-5503 Hydraulic Oil Filter..... H-5526 Hydraulic Oil Filter..... H-5504		D300D (CONSTRUCTION & MINING) CAT 3306 (S/N: 5MG1-UP) , 2005-UP Hydraulic Oil Filter..... H-5503 Hydraulic Oil Filter..... H-5504	
D250E SERIES II (DUMP TRUCKS) Hydraulic Oil Filter..... H-5504 Hydraulic Oil Filter..... H-55280 Hydraulic Oil Filter..... H-5526 Hydraulic Oil Filter..... H-55270 Hydraulic Oil Filter..... H-5503		D30D (CONSTRUCTION & MINING) CAT 3306 (S/N: 3AJ1-UP) , 2005-UP Hydraulic Oil Filter..... H-5504 Hydraulic Oil Filter..... H-5503		D300D (DUMP TRUCKS) S/N: 5MG1-UP Hydraulic Oil Filter..... H-5503 Hydraulic Oil Filter..... H-5504	
D275 (DUMP TRUCKS) S/N: 9VA1-UP Hydraulic Oil Filter..... H-5504 Hydraulic Oil Filter..... H-5503		D30D (DUMP TRUCKS) S/N: 1HK1-673 Hydraulic Oil Filter..... H-5504 Hydraulic Oil Filter..... H-5503 Hydraulic Oil Filter..... H-55270 Hydraulic Oil Filter..... H-5526 Hydraulic Oil Filter..... H-55280		D300E SERIES II (DUMP TRUCKS) Hydraulic Oil Filter..... H-5503 Hydraulic Oil Filter..... H-5526 Hydraulic Oil Filter..... H-55280 Hydraulic Oil Filter..... H-55270 Hydraulic Oil Filter..... H-5504	
D300B (CONSTRUCTION & MINING) CAT 3306 (S/N: 4SD1-573) , 2005-UP Hydraulic Oil Filter..... H-5503 Hydraulic Oil Filter..... H-5504		D30D (DUMP TRUCKS) S/N: 1HK674-UP Hydraulic Oil Filter..... H-5526 Hydraulic Oil Filter..... H-55280 Hydraulic Oil Filter..... H-5503 Hydraulic Oil Filter..... H-5504 Hydraulic Oil Filter..... H-55270		D350C (CONSTRUCTION & MINING) CAT 3306 (S/N: 8XC1-404) , 2005-UP Hydraulic Oil Filter..... H-5503 Hydraulic Oil Filter..... H-5504	
D300E (CONSTRUCTION & MINING) CAT 3306 (S/N: 7FN1-UP) , 2005-UP Hydraulic Oil Filter..... H-5503 Hydraulic Oil Filter..... H-5504		D30D (DUMP TRUCKS) S/N: 3AJ1-414 Hydraulic Oil Filter..... H-5526 Hydraulic Oil Filter..... H-5503 Hydraulic Oil Filter..... H-5504 Hydraulic Oil Filter..... H-55280 Hydraulic Oil Filter..... H-55270		D350C (DUMP TRUCKS) S/N: 8XC1-404 Hydraulic Oil Filter..... H-55270 Hydraulic Oil Filter..... H-55280 Hydraulic Oil Filter..... H-5526 Hydraulic Oil Filter..... H-5503 Hydraulic Oil Filter..... H-5504	
		D30D (CONSTRUCTION & MINING) CAT 3306 (S/N: 9RF1-UP) , 2005-UP Hydraulic Oil Filter..... H-5504 Hydraulic Oil Filter..... H-5503		D350D (CONSTRUCTION & MINING) CAT 3306 (S/N: 9RF1-UP) , 2005-UP Hydraulic Oil Filter..... H-5504 Hydraulic Oil Filter..... H-5503	



ENGINE APPLICATION

MODEL/APPLICATION	SAKURA NO	MODEL/APPLICATION	SAKURA NO	MODEL/APPLICATION	SAKURA NO
CATERPILLAR		CATERPILLAR		CATERPILLAR	
D350D (DUMP TRUCKS) S/N: 1HK1-673		Hydraulic Oil Filter.....	H-5526	D3B LGP (DOZERS) S/N: 5MC1-UP	
Hydraulic Oil Filter.....	H-5526	Hydraulic Oil Filter.....	H-5504	Hydraulic Oil Filter.....	H-55270
Hydraulic Oil Filter.....	H-5504	D35C HP (DUMP TRUCKS) S/N: 3FD1-UP		Hydraulic Oil Filter.....	H-5504
Hydraulic Oil Filter.....	H-5503	Hydraulic Oil Filter.....	H-5503	D3C (CRAWLER TRACTORS) w/3204 Eng.	
Hydraulic Oil Filter.....	H-55270	Hydraulic Oil Filter.....	H-5504	Hydraulic Oil Filter.....	H-55320
Hydraulic Oil Filter.....	H-55280	D35HP (DUMP TRUCKS) S/N: 3FD1-79		D3C (DOZERS) S/N: 1PJ1-UP	
D350D (DUMP TRUCKS) S/N: 3AJ1-414		Hydraulic Oil Filter.....	H-5504	Hydraulic Oil Filter.....	H-55270
Hydraulic Oil Filter.....	H-5503	Hydraulic Oil Filter.....	H-5503	Hydraulic Oil Filter.....	H-5504
Hydraulic Oil Filter.....	H-5504	Hydraulic Oil Filter.....	H-55280	D3C (DOZERS) S/N: 3RF1-UP	
Hydraulic Oil Filter.....	H-55280	Hydraulic Oil Filter.....	H-5526	Hydraulic Oil Filter.....	H-5504
Hydraulic Oil Filter.....	H-55270	Hydraulic Oil Filter.....	H-55270	Hydraulic Oil Filter.....	H-55270
Hydraulic Oil Filter.....	H-5526	D3B (CRAWLER TRACTORS) w/3204 Eng.		D3C (DOZERS) S/N: 4HJ1-UP	
D350D (DUMP TRUCKS) S/N: 9RF1-UP		Hydraulic Oil Filter.....	H-55320	Hydraulic Oil Filter.....	H-55270
Hydraulic Oil Filter.....	H-5504	D3B (DOZERS) S/N: 23Y1-UP		Hydraulic Oil Filter.....	H-5504
Hydraulic Oil Filter.....	H-5526	Hydraulic Oil Filter.....	H-5504	D3C (DOZERS) S/N: 4KS1-UP	
Hydraulic Oil Filter.....	H-55270	D3B (DOZERS) S/N: 24Y1-UP		Hydraulic Oil Filter.....	HC-5504
Hydraulic Oil Filter.....	H-55280	Hydraulic Oil Filter.....	H-5504	D3C (DOZERS) S/N: 4TS1-UP	
Hydraulic Oil Filter.....	H-5503	D3B (DOZERS) S/N: 27Y1-UP		Hydraulic Oil Filter.....	HC-5504
D350E (CONSTRUCTION & MINING) CAT 3406 (S/N: 2XW1-UP) , 2005-UP		Hydraulic Oil Filter.....	H-5504	D3C (DOZERS) S/N: 5CJ1-UP	
Hydraulic Oil Filter.....	H-5504	D3B (DOZERS) S/N: 28Y1-UP		Hydraulic Oil Filter.....	H-5504
Hydraulic Oil Filter.....	H-5526	Hydraulic Oil Filter.....	H-5504	Hydraulic Oil Filter.....	H-55270
D350E (CONSTRUCTION & MINING) CAT 3406 (S/N: 9LR1-UP) , 2005-UP		D3B (DOZERS) S/N: 29Y1-UP		D3C (DOZERS) S/N: 5GJ1-UP	
Hydraulic Oil Filter.....	H-5504	Hydraulic Oil Filter.....	H-5504	Hydraulic Oil Filter.....	HC-5504
Hydraulic Oil Filter.....	H-5503	D3B (DOZERS) S/N: 2PC1-245		D3C (DOZERS) S/N: 5KG1-UP	
D350E (DUMP TRUCKS) S/N: 9LR1-UP		Hydraulic Oil Filter.....	H-5501	Hydraulic Oil Filter.....	H-5504
Hydraulic Oil Filter.....	H-55280	D3B (DOZERS) S/N: 2PC1-UP		Hydraulic Oil Filter.....	H-55270
Hydraulic Oil Filter.....	H-5504	Hydraulic Oil Filter.....	H-55270	D3C (DOZERS) S/N: 5ZG1-UP	
Hydraulic Oil Filter.....	H-55270	D3B (DOZERS) S/N: 2PC246-UP		Hydraulic Oil Filter.....	H-55270
Hydraulic Oil Filter.....	H-5503	Hydraulic Oil Filter.....	H-5504	Hydraulic Oil Filter.....	H-5504
Hydraulic Oil Filter.....	H-5526	Hydraulic Oil Filter.....	H-5501	D3C (DOZERS) S/N: 6PF1-UP	
D35C (CONSTRUCTION & MINING) CAT 3306 (S/N: 2GD1-124) , 2005-UP		D3B (DOZERS) S/N: 3YC1-UP		Hydraulic Oil Filter.....	H-55270
Hydraulic Oil Filter.....	H-5503	Hydraulic Oil Filter.....	H-5501	Hydraulic Oil Filter.....	H-5504
Hydraulic Oil Filter.....	H-5504	D3B (DOZERS) S/N: 5MC1-UP		D3C (DOZERS) S/N: 6SL1-UP	
D35C (DUMP TRUCKS) S/N: 2GD1-124		Hydraulic Oil Filter.....	H-5501	Hydraulic Oil Filter.....	H-55270
Hydraulic Oil Filter.....	H-5526	Hydraulic Oil Filter.....	H-5504	Hydraulic Oil Filter.....	H-5504
Hydraulic Oil Filter.....	H-55280	D3B (DOZERS) S/N: 3YC1-UP		D3C (DOZERS) S/N: 7JF1-UP	
Hydraulic Oil Filter.....	H-55270	Hydraulic Oil Filter.....	H-5501	Hydraulic Oil Filter.....	H-5504
Hydraulic Oil Filter.....	H-5503	D3B LGP (DOZERS) S/N: 3YC1-UP		Hydraulic Oil Filter.....	H-55270
Hydraulic Oil Filter.....	H-5504	Hydraulic Oil Filter.....	H-5504	Hydraulic Oil Filter.....	H-5504
D35 HP (CONSTRUCTION & MINING) CAT 3406 (S/N: 3FD1-79) , 2005-UP		Hydraulic Oil Filter.....	H-55270	D3C (DOZERS) S/N: 7JF1-UP	
Hydraulic Oil Filter.....	H-5504	D3B (DOZERS) S/N: 3YC1-UP		Hydraulic Oil Filter.....	H-5504
Hydraulic Oil Filter.....	H-5503	Hydraulic Oil Filter.....	H-5504	Hydraulic Oil Filter.....	H-55270
D350E SERIES II (DUMP TRUCKS) CAT 3406E (S/N: 2XW1-UP)		Hydraulic Oil Filter.....	H-5504		
Hydraulic Oil Filter.....	H-55270				



ENGINE APPLICATION

MODEL/APPLICATION	SAKURA NO	MODEL/APPLICATION	SAKURA NO	MODEL/APPLICATION	SAKURA NO
CATERPILLAR		CATERPILLAR		CATERPILLAR	
D3C (DOZERS) S/N: 7JG1-UP Hydraulic Oil Filter..... H-55270 Hydraulic Oil Filter..... H-5504		D3C SERIES III (DOZERS) S/N: 4KS1-394 Hydraulic Oil Filter..... HC-5504		D3K (CRAWLERS) CAT S/N: LLL1-UP , 2007-UP Hydraulic Oil Filter..... HC-5504	
D3C (DOZERS) S/N: 7XL1-UP Hydraulic Oil Filter..... H-5504 Hydraulic Oil Filter..... H-55270		D3C SERIES III (DOZERS) S/N: 4KS395-UP Hydraulic Oil Filter..... HC-5504		D400 (CONSTRUCTION & MINING) CAT 3406B (S/N: 1MD1-246) , 2005-UP Hydraulic Oil Filter..... H-5504 Hydraulic Oil Filter..... H-5503	
D3C (DOZERS) S/N: 8BF1-UP Hydraulic Oil Filter..... H-5504 Hydraulic Oil Filter..... H-55270		D3C SERIES III (DOZERS) S/N: 5GS1-373 Hydraulic Oil Filter..... HC-5504		D400 (DUMP TRUCKS) CAT 3406 (S/N: 1MD-UP) Hydraulic Oil Filter..... H-5503 Hydraulic Oil Filter..... H-5504 Hydraulic Oil Filter..... H-55270	
D3C (DOZERS) S/N: 8DG1-UP Hydraulic Oil Filter..... H-55270 Hydraulic Oil Filter..... H-5504		D3C SERIES III (DOZERS) S/N: 5GS374-UP Hydraulic Oil Filter..... HC-5504		D400 (DUMP TRUCKS) CAT 3406 (S/N: 2JJ-UP) Hydraulic Oil Filter..... H-5504 Hydraulic Oil Filter..... H-55270 Hydraulic Oil Filter..... H-5503	
D3C LGP (DOZERS) S/N: 1PJ1-UP Hydraulic Oil Filter..... H-5504 Hydraulic Oil Filter..... H-55270		D3C SERIES III (DOZERS) S/N: 6SL1-2555 Hydraulic Oil Filter..... H-55270 Hydraulic Oil Filter..... H-5501		D400 (DUMP TRUCKS) CAT 3406 (S/N: 2YR-UP) Hydraulic Oil Filter..... H-5504 Hydraulic Oil Filter..... H-5503 Hydraulic Oil Filter..... H-55270	
D3C LGP (DOZERS) S/N: 5KG1-UP Hydraulic Oil Filter..... H-55270 Hydraulic Oil Filter..... H-5504		D3C SERIES III (DOZERS) S/N: 6SL2556-UP Hydraulic Oil Filter..... H-5501 Hydraulic Oil Filter..... H-55270		D400 (DUMP TRUCKS) CAT 3406 (S/N: 8TF-UP) Hydraulic Oil Filter..... H-5504 Hydraulic Oil Filter..... H-55270 Hydraulic Oil Filter..... H-5503	
D3C LGP (DOZERS) S/N: 8BF1-UP Hydraulic Oil Filter..... H-5504 Hydraulic Oil Filter..... H-55270		D3C SERIES III (DOZERS) S/N: 7XL1108-UP Hydraulic Oil Filter..... H-5501 Hydraulic Oil Filter..... H-55270		D400 (DUMP TRUCKS) S/N: 1MD1-246 Hydraulic Oil Filter..... H-5504 Hydraulic Oil Filter..... H-55280 Hydraulic Oil Filter..... H-5503 Hydraulic Oil Filter..... H-5526 Hydraulic Oil Filter..... H-55270	
D3C LGP XL SERIES III (DOZERS) S/N: 4KS1-UP Hydraulic Oil Filter..... HC-5504		D3G (TRACTORS) S/N: BYR1-UP Hydraulic Oil Filter..... HC-5504 Hydraulic Oil Filter..... HC-5507		D400D (CONSTRUCTION & MINING) CAT 3406 (S/N: 8TF1-UP) , 2005-UP Hydraulic Oil Filter..... H-5503 Hydraulic Oil Filter..... H-5504	
D3C LGP XL SERIES III (DOZERS) S/N: 4TS1-UP Hydraulic Oil Filter..... HC-5504		D3G (TRACTORS) S/N: CFC1-UP Hydraulic Oil Filter..... HC-5507 Hydraulic Oil Filter..... HC-5504 Hydraulic Oil Filter..... HC-55220		D400D (DUMP TRUCKS) S/N: 8TF1-UP Hydraulic Oil Filter..... H-5503 Hydraulic Oil Filter..... H-5504	
D3C LGP XL SERIES III (DOZERS) S/N: 5GS1-UP Hydraulic Oil Filter..... HC-5504		D3G (TRACTORS) S/N: CFF1-UP Hydraulic Oil Filter..... HC-55220 Hydraulic Oil Filter..... HC-5504 Hydraulic Oil Filter..... HC-5507		D400E (CONSTRUCTION & MINING) CAT 3406 (S/N: 2YR1-UP) , 2005-UP Hydraulic Oil Filter..... H-5504 Hydraulic Oil Filter..... H-5503	
D3C LGP XL SERIES III (DOZERS) S/N: 6SL1-UP Hydraulic Oil Filter..... H-55270 Hydraulic Oil Filter..... H-5504		D3G (TRACTORS) S/N: JMH1-UP Hydraulic Oil Filter..... HC-5507 Hydraulic Oil Filter..... HC-5504		D400E (CONSTRUCTION & MINING) CAT 3406 (S/N: 8PS1-UP) , 2005-UP Hydraulic Oil Filter..... H-5526 Hydraulic Oil Filter..... H-5504	
D3C LGP XL SERIES III (DOZERS) S/N: 7XL1-UP Hydraulic Oil Filter..... H-5504 Hydraulic Oil Filter..... H-55270		D3K (CRAWLERS) CAT S/N: C4E1-49-UP , 2007-UP Hydraulic Oil Filter..... HC-5504		D400E (CONSTRUCTION & MINING) CAT 3406 (S/N: APF00274-UP) , 2005-UP Hydraulic Oil Filter..... H-5526	
D3C SERIES II (CRAWLER TRACTORS) w/3204 Eng. Hydraulic Oil Filter..... H-55320		D3K (CRAWLERS) CAT S/N: C4E50-UP , 2007-UP Hydraulic Oil Filter..... HC-5504			
D3C SERIES II (DOZERS) S/N: 8DG1-UP Hydraulic Oil Filter..... H-55270 Hydraulic Oil Filter..... H-5504					



ENGINE APPLICATION

MODEL/APPLICATION	SAKURA NO	MODEL/APPLICATION	SAKURA NO	MODEL/APPLICATION	SAKURA NO
CATERPILLAR		CATERPILLAR		CATERPILLAR	
D400E (CONSTRUCTION & MINING) CAT 3406 (S/N: APF00274-UP) , 2005-UP Hydraulic Oil Filter.....	H-5504	D4 (DOZERS) S/N: 8431-1389 Hydraulic Oil Filter.....	H-5504	D4C (DOZERS) S/N: 6BS1-UP Hydraulic Oil Filter.....	HC-5504
D400E (DUMP TRUCKS) CAT 3406E (S/N: APF-UP) Hydraulic Oil Filter..... Hydraulic Oil Filter.....	H-5504 H-55270	D4 (DOZERS) S/N: 8431390-UP Hydraulic Oil Filter.....	H-5504	D4C (DOZERS) S/N: 6YL1-UP Hydraulic Oil Filter..... Hydraulic Oil Filter.....	H-5504 H-55270
D400E (DUMP TRUCKS) S/N: 2YR1-UP Hydraulic Oil Filter..... Hydraulic Oil Filter..... Hydraulic Oil Filter..... Hydraulic Oil Filter..... Hydraulic Oil Filter.....	H-5526 H-5503 H-55270 H-55280 H-5504	D400 SERIES II (DUMP TRUCKS) S/N: 2YR-UP Hydraulic Oil Filter..... Hydraulic Oil Filter..... Hydraulic Oil Filter.....	H-5504 H-5503 H-55270	D4C (DOZERS) S/N: 7SL1-UP Hydraulic Oil Filter.....	H-5504
D400E II (CONSTRUCTION & MINING) CAT 3406B (S/N: 8PS1-UP) , 2005-UP Hydraulic Oil Filter..... Hydraulic Oil Filter.....	H-5504 H-5526	D400 SERIES II (DUMP TRUCKS) S/N: 8PS-UP Hydraulic Oil Filter..... Hydraulic Oil Filter..... Hydraulic Oil Filter.....	H-5504 H-55270 H-5503	D4C (DOZERS) S/N: 8CS1-UP Hydraulic Oil Filter.....	HC-5504
D40D (CONSTRUCTION & MINING) CAT 3406 (S/N: 2JJ1-UP) , 2005-UP Hydraulic Oil Filter..... Hydraulic Oil Filter.....	H-5504 H-5503	D400E SERIES II (DUMP TRUCKS) CAT 3406E (S/N: 8PS1-UP) Hydraulic Oil Filter..... Hydraulic Oil Filter..... Hydraulic Oil Filter.....	H-5504 H-5526 H-55270	D4C LGP XL SERIES III (DOZERS) S/N: 6BS1-UP Hydraulic Oil Filter.....	HC-5504
D40D (CONSTRUCTION & MINING) CAT 3406 (S/N: 8TF1-UP) , 2005-UP Hydraulic Oil Filter..... Hydraulic Oil Filter.....	H-5504 H-5503	D44 (DUMP TRUCKS) S/N: 2LD1-UP Hydraulic Oil Filter.....	H-5503	D4C LGP XL SERIES III (DOZERS) S/N: 8CS1-UP Hydraulic Oil Filter.....	HC-5504
D40D (DUMP TRUCKS) S/N: 1TF-UP Hydraulic Oil Filter..... Hydraulic Oil Filter.....	H-5503 H-5504	D44B (CONSTRUCTION & MINING) CAT 3408 (S/N: 8SD1-UP) , 2005-UP Hydraulic Oil Filter..... Hydraulic Oil Filter.....	H-5503 H-5504	D4C SERIES III (DOZERS) S/N: 6BS1-320 Hydraulic Oil Filter.....	HC-5504
D40D (DUMP TRUCKS) S/N: 2JJ-UP Hydraulic Oil Filter..... Hydraulic Oil Filter.....	H-5503 H-5504	D44B (DUMP TRUCKS) S/N: 8SD1-UP Hydraulic Oil Filter..... Hydraulic Oil Filter..... Hydraulic Oil Filter..... Hydraulic Oil Filter..... Hydraulic Oil Filter.....	H-55270 H-55280 H-5503 H-5526 H-5504	D4C SERIES III (DOZERS) S/N: 6BS321-UP Hydraulic Oil Filter.....	HC-5504
D4 (DOZERS) Excluding S/N: 82J3256 Hydraulic Oil Filter.....	H-5504	D4B (CRAWLER TRACTORS) Hydraulic Oil Filter.....	H-55320	D4C SERIES III (DOZERS) S/N: 8CS1-373 Hydraulic Oil Filter.....	HC-5504
D4 (DOZERS) S/N: 82J1-3259 Hydraulic Oil Filter.....	H-5504	D4B (DOZERS) S/N: 15G1-UP Hydraulic Oil Filter..... Hydraulic Oil Filter.....	H-55270 H-5504	D4C SERIES III (DOZERS) S/N: 8CS374-UP Hydraulic Oil Filter.....	HC-5504
D4 (DOZERS) S/N: 82J1811-UP Hydraulic Oil Filter.....	H-5504	D4B (DOZERS) S/N: 2XF1-UP Hydraulic Oil Filter..... Hydraulic Oil Filter.....	H-5504 H-55270	D4D (DOZERS) S/N: 22C1-655 Hydraulic Oil Filter.....	H-5504
D4 (DOZERS) S/N: 82J3256-UP Hydraulic Oil Filter.....	H-5504	D4C (DOZERS) S/N: 1FW1-UP Hydraulic Oil Filter..... Hydraulic Oil Filter.....	H-5504 H-55270	D4D (DOZERS) S/N: 59J1-UP Hydraulic Oil Filter.....	H-5504
D4 (DOZERS) S/N: 82J3260-UP Hydraulic Oil Filter.....	H-5504	D4B (DOZERS) S/N: 8SD1-UP Hydraulic Oil Filter..... Hydraulic Oil Filter.....	H-55270 H-5504	D4D (DOZERS) S/N: 7R1-UP Hydraulic Oil Filter.....	H-5504
D4 (DOZERS) S/N: 83J1-1810 Hydraulic Oil Filter.....	H-5504	D4C (DOZERS) S/N: 4LS1-UP Hydraulic Oil Filter.....	HC-5504	D4D (DOZERS) S/N: 82J1-3443 Hydraulic Oil Filter.....	H-5504
		D4C (DOZERS) S/N: 4LS1-UP Hydraulic Oil Filter.....	HC-5504	D4D (DOZERS) S/N: 82J4151-UP Hydraulic Oil Filter.....	H-5504
				D4D (DOZERS) S/N: 83J1-1810	



ENGINE APPLICATION

MODEL/APPLICATION	SAKURA NO	MODEL/APPLICATION	SAKURA NO	MODEL/APPLICATION	SAKURA NO
CATERPILLAR		CATERPILLAR		CATERPILLAR	
D4D (DOZERS) S/N: 83J1-1810 Hydraulic Oil Filter.....	H-5504	Hydraulic Oil Filter.....	H-5504	D4E (DOZERS) S/N: 69X1-UP Hydraulic Oil Filter.....	H-5504
D4E (CRAWLER TRACTORS) w/3304 Eng. Hydraulic Oil Filter.....	H-55320	D4E (DOZERS) S/N: 31C100-UP Hydraulic Oil Filter.....	H-55270	D4E (DOZERS) S/N: 70X1-UP Hydraulic Oil Filter.....	H-5504
D4E (DOZERS) S/N: 27X1-UP Hydraulic Oil Filter.....	H-5504	Hydraulic Oil Filter.....	H-5504	D4E (DOZERS) S/N: 70X825-902 Hydraulic Oil Filter.....	H-5504
D4E (DOZERS) S/N: 28X1-1726 Hydraulic Oil Filter.....	H-5504	D4E (DOZERS) S/N: 31C314-UP Hydraulic Oil Filter.....	H-55270	D4E (DOZERS) S/N: 70X903-920 Hydraulic Oil Filter.....	H-5504
D4E (DOZERS) S/N: 28X1727-UP Hydraulic Oil Filter.....	H-5504	Hydraulic Oil Filter.....	H-5504	D4E (DOZERS) S/N: 70X921-UP Hydraulic Oil Filter.....	H-5504
D4E (DOZERS) S/N: 28X1-UP Hydraulic Oil Filter.....	H-55270	D4E (DOZERS) S/N: 34C100-UP Hydraulic Oil Filter.....	H-5504	D4E (DOZERS) S/N: 71X1-UP Hydraulic Oil Filter.....	H-5504
Hydraulic Oil Filter.....	H-5504	Hydraulic Oil Filter.....	H-5504	D4E (DOZERS) S/N: 71X426-429 Hydraulic Oil Filter.....	H-5504
D4E (DOZERS) S/N: 29X1-UP Hydraulic Oil Filter.....	H-5504	D4E (DOZERS) S/N: 51X1-841 Hydraulic Oil Filter.....	H-5504	D4E (DOZERS) S/N: 71X430-UP Hydraulic Oil Filter.....	H-5504
D4E (DOZERS) S/N: 2CB1-381 Hydraulic Oil Filter.....	H-5504	D4E (DOZERS) S/N: 51X842-UP Hydraulic Oil Filter.....	H-5504	D4E (DOZERS) S/N: 71X430-UP Hydraulic Oil Filter.....	H-5504
D4E (DOZERS) S/N: 2CB1-UP Hydraulic Oil Filter.....	H-5504	Hydraulic Oil Filter.....	H-55270	D4E (DOZERS) S/N: 72X1-UP Hydraulic Oil Filter.....	H-5504
Hydraulic Oil Filter.....	H-55270	D4E (DOZERS) S/N: 52X1-1162 Hydraulic Oil Filter.....	H-5504	D4E (DOZERS) S/N: 72X639-650 Hydraulic Oil Filter.....	H-5504
D4E (DOZERS) S/N: 2CB382-UP Hydraulic Oil Filter.....	H-5504	D4E (DOZERS) S/N: 52X1163-UP Hydraulic Oil Filter.....	H-5504	D4E (DOZERS) S/N: 72X666-UP Hydraulic Oil Filter.....	H-5504
D4E (DOZERS) S/N: 2DJ1766-1831 Hydraulic Oil Filter.....	HC-5506	Hydraulic Oil Filter.....	H-5504	D4E (DOZERS) S/N: 72W1-2504 Hydraulic Oil Filter.....	H-5504
Hydraulic Oil Filter.....	HC-5503	D4E (DOZERS) S/N: 52X1163-UP Hydraulic Oil Filter.....	H-5504	D4E (DOZERS) S/N: 72W639-650 Hydraulic Oil Filter.....	H-5504
Hydraulic Oil Filter.....	H-5504	Hydraulic Oil Filter.....	H-5504	D4E (DOZERS) S/N: 72W666-UP Hydraulic Oil Filter.....	H-5504
Hydraulic Oil Filter.....	HC-5512	D4E (DOZERS) S/N: 68X1-UP Hydraulic Oil Filter.....	H-5504	D4E (DOZERS) S/N: 72W666-UP Hydraulic Oil Filter.....	H-5504
D4E (DOZERS) S/N: 2DJ1-828 Hydraulic Oil Filter.....	H-5504	Hydraulic Oil Filter.....	H-5504	D4E (DOZERS) S/N: 72W666-UP Hydraulic Oil Filter.....	H-5504
D4E (DOZERS) S/N: 2DJ1832-UP Hydraulic Oil Filter.....	HC-5512	D4E (DOZERS) S/N: 68X852-871 Hydraulic Oil Filter.....	H-5504	D4E (DOZERS) S/N: 72W666-UP Hydraulic Oil Filter.....	H-5504
Hydraulic Oil Filter.....	HC-5503	Hydraulic Oil Filter.....	H-5504	D4E (DOZERS) S/N: 72W666-UP Hydraulic Oil Filter.....	H-5504
Hydraulic Oil Filter.....	HC-5506	D4E (DOZERS) S/N: 68X872-UP Hydraulic Oil Filter.....	H-5504	D4E (DOZERS) S/N: 72W666-UP Hydraulic Oil Filter.....	H-5504
Hydraulic Oil Filter.....	H-5504	Hydraulic Oil Filter.....	H-5504	D4E (DOZERS) S/N: 72W666-UP Hydraulic Oil Filter.....	H-5504
D4E (DOZERS) S/N: 2DJ829-1765 Hydraulic Oil Filter.....	H-5504	D4E (DOZERS) S/N: 69X1504-1531 Hydraulic Oil Filter.....	H-5504	D4E (DOZERS) S/N: 72W666-UP Hydraulic Oil Filter.....	H-5504
D4E (DOZERS) S/N: 31C100-313		Hydraulic Oil Filter.....	H-5504	D4E (DOZERS) S/N: 72W666-UP Hydraulic Oil Filter.....	H-5504
		D4E (DOZERS) S/N: 69X1532-UP Hydraulic Oil Filter.....	H-5504	D4E (DOZERS) S/N: 72W666-UP Hydraulic Oil Filter.....	H-5504
		Hydraulic Oil Filter.....	H-5504	D4E (DOZERS) S/N: 72W666-UP Hydraulic Oil Filter.....	H-5504



ENGINE APPLICATION

MODEL/APPLICATION	SAKURA NO	MODEL/APPLICATION	SAKURA NO	MODEL/APPLICATION	SAKURA NO
CATERPILLAR		CATERPILLAR		CATERPILLAR	
D4E (DOZERS) S/N: 77W1144-1663		Hydraulic Oil Filter.....	H-55270	D4H (CRAWLERS) S/N: 9DB1-3999	
Hydraulic Oil Filter.....	H-55270	Hydraulic Oil Filter.....	H-5504	Hydraulic Oil Filter.....	H-5504
Hydraulic Oil Filter.....	H-5504	D4H (CRAWLERS) S/N: 2AC376-551		Hydraulic Oil Filter.....	H-55270
D4E (DOZERS) S/N: 77W1664-UP		Hydraulic Oil Filter.....	H-55270	D4H (CRAWLERS) S/N: 9DB1-UP	
Hydraulic Oil Filter.....	H-55270	D4H (CRAWLERS) S/N: 2AC4000-UP		Hydraulic Oil Filter.....	H-55270
Hydraulic Oil Filter.....	H-5504	Hydraulic Oil Filter.....	H-5504	D4H (CRAWLERS) S/N: 9DB4000-UP	
D4E (DOZERS) S/N: 77W1-UP		Hydraulic Oil Filter.....	H-55270	Hydraulic Oil Filter.....	H-55270
Hydraulic Oil Filter.....	H-5504	D4H (CRAWLERS) S/N: 2AC5500-UP		Hydraulic Oil Filter.....	H-55270
D4E (DOZERS) S/N: 7PB1-649		Hydraulic Oil Filter.....	H-5504	Hydraulic Oil Filter.....	H-5504
Hydraulic Oil Filter.....	H-5504	Hydraulic Oil Filter.....	H-55270	D4H (CRAWLERS) S/N: 9FB1-UP	
D4E (DOZERS) S/N: 7PB1-UP		D4H (CRAWLERS) S/N: 2AC552-5499		Hydraulic Oil Filter.....	H-5501
Hydraulic Oil Filter.....	H-5504	Hydraulic Oil Filter.....	H-55270	D4H (CRAWLERS) S/N: 9GJ1-UP	
Hydraulic Oil Filter.....	H-55270	Hydraulic Oil Filter.....	H-5504	Hydraulic Oil Filter.....	H-5504
D4E (DOZERS) S/N: 7PB650-UP		D4H (CRAWLERS) S/N: 2CC1-UP		D4H LGP (CRAWLERS) S/N: 2AC1-3999	
Hydraulic Oil Filter.....	H-5504	Hydraulic Oil Filter.....	H-5501	Hydraulic Oil Filter.....	H-5504
D4E SR (CRAWLER TRACTORS) w/3304 Eng.		D4H (CRAWLERS) S/N: 3AC1-388		Hydraulic Oil Filter.....	H-55270
Hydraulic Oil Filter.....	H-55320	Hydraulic Oil Filter.....	H-55270	D4H LGP (CRAWLERS) S/N: 2AC4000-UP	
D4G (TRACTORS) S/N: CFN1-UP		D4H (CRAWLERS) S/N: 3AC1-3999		Hydraulic Oil Filter.....	H-5504
Hydraulic Oil Filter.....	HC-5504	Hydraulic Oil Filter.....	H-55280	Hydraulic Oil Filter.....	H-55270
Hydraulic Oil Filter.....	HC-55220	Hydraulic Oil Filter.....	H-5504	D4H LGP (CRAWLERS) S/N: 3AC1-3999	
Hydraulic Oil Filter.....	HC-5507	D4H (CRAWLERS) S/N: 3AC389-581		Hydraulic Oil Filter.....	H-5504
D4G (TRACTORS) S/N: FDC1-UP		Hydraulic Oil Filter.....	H-55270	Hydraulic Oil Filter.....	H-55270
Hydraulic Oil Filter.....	HC-5504	D4H (CRAWLERS) S/N: 3AC4000-UP		D4H LGP (CRAWLERS) S/N: 4NK1-UP	
Hydraulic Oil Filter.....	HC-55220	Hydraulic Oil Filter.....	H-55270	Hydraulic Oil Filter.....	H-5504
Hydraulic Oil Filter.....	HC-5507	Hydraulic Oil Filter.....	H-5504	Hydraulic Oil Filter.....	H-55270
D4G (TRACTORS) S/N: HYD1-UP		D4H (CRAWLERS) S/N: 3AC582-UP		D4H LGP (CRAWLERS) S/N: 8PB1-3999	
Hydraulic Oil Filter.....	HC-55220	Hydraulic Oil Filter.....	H-5504	Hydraulic Oil Filter.....	H-55270
Hydraulic Oil Filter.....	HC-5504	Hydraulic Oil Filter.....	H-55270	Hydraulic Oil Filter.....	H-5504
Hydraulic Oil Filter.....	HC-5507	D4H (CRAWLERS) S/N: 4NK1-UP		D4H LGP (CRAWLERS) S/N: 9DB1-3999	
D4G (TRACTORS) S/N: TLX1-UP		Hydraulic Oil Filter.....	H-5504	Hydraulic Oil Filter.....	H-55270
Hydraulic Oil Filter.....	HC-5507	D4H (CRAWLERS) S/N: 8PB1-3999		Hydraulic Oil Filter.....	H-5504
Hydraulic Oil Filter.....	HC-55220	Hydraulic Oil Filter.....	H-55270	Hydraulic Oil Filter.....	H-55270
Hydraulic Oil Filter.....	HC-5504	Hydraulic Oil Filter.....	H-5504	D4H LGP SERIES II (CRAWLERS) S/N: 3AC4000-UP	
D4H (CRAWLERS) S/N: 1WB1-UP		D4H (CRAWLERS) S/N: 8PB1-UP		Hydraulic Oil Filter.....	H-5504
Hydraulic Oil Filter.....	H-5501	Hydraulic Oil Filter.....	H-55270	Hydraulic Oil Filter.....	H-55270
D4H (CRAWLERS) S/N: 2AC1-375		Hydraulic Oil Filter.....	H-5504	D4H LGP SERIES II (CRAWLERS) S/N: 8PB4000-UP	
Hydraulic Oil Filter.....	H-55270	D4H (CRAWLERS) S/N: 8PB1-UP		Hydraulic Oil Filter.....	H-5504
D4H (CRAWLERS) S/N: 2AC1-3999		Hydraulic Oil Filter.....	H-55270	Hydraulic Oil Filter.....	H-55270
Hydraulic Oil Filter.....	H-55270	D4H (CRAWLERS) S/N: 8PB4000-UP		D4H LGP SERIES II (CRAWLERS) S/N: 9DB4000-UP	
D4H (CRAWLERS) S/N: 2AC1-3999		Hydraulic Oil Filter.....	H-5504	Hydraulic Oil Filter.....	H-5504



ENGINE APPLICATION

MODEL/APPLICATION	SAKURA NO	MODEL/APPLICATION	SAKURA NO	MODEL/APPLICATION	SAKURA NO
CATERPILLAR		CATERPILLAR		CATERPILLAR	
D4H LGP SERIES II (CRAWLERS) S/N: 9DB4000-UP Hydraulic Oil Filter.....	H-55270	D4H TSK (CRAWLERS) S/N: 8ZF1-UP Hydraulic Oil Filter.....	H-5504	Hydraulic Oil Filter.....	H-5504
D4H LGP SERIES III (CRAWLERS) S/N: 8PJ1-UP Hydraulic Oil Filter.....	H-55270	D4H XL (CRAWLERS) S/N: 8PJ1-UP Hydraulic Oil Filter.....	H-55270	D5 (CRAWLERS) S/N: 81H1-UP Hydraulic Oil Filter.....	H-5504
Hydraulic Oil Filter.....	H-5504	Hydraulic Oil Filter.....	H-5504	D5 (CRAWLERS) S/N: 82H1-UP Hydraulic Oil Filter.....	H-5504
D4H LGP SERIES III (CRAWLERS) S/N: 9GJ1-UP Hydraulic Oil Filter.....	H-5504	D4H XL (CRAWLERS) S/N: 9GJ1-UP Hydraulic Oil Filter.....	H-55270	D5 (CRAWLERS) S/N: 83H1-455 Hydraulic Oil Filter.....	H-5504
Hydraulic Oil Filter.....	H-55270	Hydraulic Oil Filter.....	H-5504	D5 (CRAWLERS) S/N: 84H1-809 Hydraulic Oil Filter.....	H-5504
D4H SERIES II (CRAWLERS) CAT (S/N: 7BG1-UP) Hydraulic Oil Filter.....	H-5501	D4HTKS II (SKIDDERS) CAT S/N: 45V1-UP Hydraulic Oil Filter.....	H-55270	D5 (CRAWLERS) S/N: 93J1-731 Hydraulic Oil Filter.....	H-5504
Hydraulic Oil Filter.....	H-5501	Hydraulic Oil Filter.....	H-5501	D5 (CRAWLERS) S/N: 93J732-904 Hydraulic Oil Filter.....	H-5504
D4H SERIES II (CRAWLERS) S/N: 2AC1-375 Hydraulic Oil Filter.....	H-55270	D4HTKS II (SKIDDERS) CAT S/N: 7BG1-UP Hydraulic Oil Filter.....	H-55270	D5 (CRAWLERS) S/N: 93J905-UP Hydraulic Oil Filter.....	H-5504
Hydraulic Oil Filter.....	H-55270	Hydraulic Oil Filter.....	H-5501	D5 (CRAWLERS) S/N: 94J1-1704 Hydraulic Oil Filter.....	H-5504
D4H SERIES II (CRAWLERS) S/N: 2AC376-551 Hydraulic Oil Filter.....	H-55270	D4HTKS II (SKIDDERS) CAT S/N: 7YJ1-UP Hydraulic Oil Filter.....	H-55270	D5 (CRAWLERS) S/N: 94J1705-2448 Hydraulic Oil Filter.....	H-5504
Hydraulic Oil Filter.....	H-55270	Hydraulic Oil Filter.....	H-55270	D5 (CRAWLERS) S/N: 94J2449-UP Hydraulic Oil Filter.....	H-5504
D4H SERIES II (CRAWLERS) S/N: 2AC552-5499 Hydraulic Oil Filter.....	H-5504	D4HTKS III (SKIDDERS) S/N: 2EJ1-UP Hydraulic Oil Filter.....	H-5501	D5 (CRAWLERS) S/N: 95J1-356 Hydraulic Oil Filter.....	H-5504
Hydraulic Oil Filter.....	H-55270	Hydraulic Oil Filter.....	H-5501	D5 (CRAWLERS) S/N: 95J357-UP Hydraulic Oil Filter.....	H-5504
D4H SERIES II (CRAWLERS) S/N: 3AC1-388 Hydraulic Oil Filter.....	H-55270	D4HTKS III (SKIDDERS) S/N: 7PK1-106-UP Hydraulic Oil Filter.....	H-55270	D5 (CRAWLERS) S/N: 96J1-3587 Hydraulic Oil Filter.....	H-5504
Hydraulic Oil Filter.....	H-55270	Hydraulic Oil Filter.....	H-55270	D5 (CRAWLERS) S/N: 96J3588-5261 Hydraulic Oil Filter.....	H-5504
D4H SERIES II (CRAWLERS) S/N: 3AC389-581 Hydraulic Oil Filter.....	H-55270	D4K (CRAWLERS) CAT S/N: C4E1-49-UP , 2005-UP Hydraulic Oil Filter.....	HC-5504	D5 (CRAWLERS) S/N: 98J1-1133 Hydraulic Oil Filter.....	H-5504
Hydraulic Oil Filter.....	H-55270	Hydraulic Oil Filter.....	HC-5504	D5 (CRAWLERS) S/N: 98J1134-1590 Hydraulic Oil Filter.....	H-5504
D4H SERIES II (CRAWLERS) S/N: 3AC582-UP Hydraulic Oil Filter.....	H-5504	D4K (CRAWLERS) CAT S/N: C4E50-UP , 2005-UP Hydraulic Oil Filter.....	HC-5504	D5 (CRAWLERS) S/N: 98J1591-UP	
Hydraulic Oil Filter.....	H-55270	Hydraulic Oil Filter.....	HC-5504		
D4H SERIES II (CRAWLERS) S/N: 8PB1-UP Hydraulic Oil Filter.....	H-55270	D5 (CRAWLER TRACTORS) w/3306 Eng. Hydraulic Oil Filter.....	H-55320		
Hydraulic Oil Filter.....	H-55270	Hydraulic Oil Filter.....	H-55320		
D4H SERIES II (CRAWLERS) S/N: 9DB1-UP Hydraulic Oil Filter.....	H-55270	D5 (CRAWLERS) S/N: 12R1-UP Hydraulic Oil Filter.....	H-5504		
Hydraulic Oil Filter.....	H-55270	Hydraulic Oil Filter.....	H-5504		
D4H SERIES III (CRAWLERS) CAT S/N: 09Z10600-UP Hydraulic Oil Filter.....	H-55270	D5 (CRAWLERS) S/N: 6R1-UP			
Hydraulic Oil Filter.....	H-5504				
D4H SERIES III (CRAWLERS) CAT S/N: 4NK1-UP Hydraulic Oil Filter.....	H-5504				
Hydraulic Oil Filter.....	H-55270				



ENGINE APPLICATION

MODEL/APPLICATION	SAKURA NO	MODEL/APPLICATION	SAKURA NO	MODEL/APPLICATION	SAKURA NO
CATERPILLAR		CATERPILLAR		CATERPILLAR	
D5 (CRAWLERS) S/N: 98J1591-UP Hydraulic Oil Filter.....	H-5504	Hydraulic Oil Filter.....	H-5504	Hydraulic Oil Filter.....	H-5504
D550 (DUMP TRUCKS) S/N: 4RD1-UP Hydraulic Oil Filter.....	H-5503	D5B (CRAWLERS) S/N: 26X827-UP Hydraulic Oil Filter.....	H-55270	Hydraulic Oil Filter.....	H-55270
Hydraulic Oil Filter.....	H-5504	Hydraulic Oil Filter.....	H-5504	D5C (CRAWLERS) S/N: 5HS1-UP Hydraulic Oil Filter.....	HC-5504
D550B (CONSTRUCTION & MINING) CAT 3408 (S/N: 5ND1-UP) , 2005-UP Hydraulic Oil Filter.....	H-5503	D5B (CRAWLERS) S/N: 27Y1-UP Hydraulic Oil Filter.....	H-5504	D5C (CRAWLERS) S/N: 6CS1-UP Hydraulic Oil Filter.....	HC-5504
Hydraulic Oil Filter.....	H-5504	D5B (CRAWLERS) S/N: 43X1-UP Hydraulic Oil Filter.....	H-5504	D5C (CRAWLERS) S/N: 6PJ1-UP Hydraulic Oil Filter.....	H-55270
D550B (DUMP TRUCKS) S/N: 5ND1-UP Hydraulic Oil Filter.....	H-5504	Hydraulic Oil Filter.....	H-5508	Hydraulic Oil Filter.....	H-5504
Hydraulic Oil Filter.....	H-55270	D5B (CRAWLERS) S/N: 44X1-UP Hydraulic Oil Filter.....	H-5504	D5C (CRAWLERS) S/N: 6ZL1-UP Hydraulic Oil Filter.....	H-55270
Hydraulic Oil Filter.....	H-5503	Hydraulic Oil Filter.....	H-5508	Hydraulic Oil Filter.....	H-5504
Hydraulic Oil Filter.....	H-5526	D5B (CRAWLERS) S/N: 45X1-UP Hydraulic Oil Filter.....	H-5504	D5C (CRAWLERS) S/N: 7PS1-UP Hydraulic Oil Filter.....	HC-5504
Hydraulic Oil Filter.....	H-55280	Hydraulic Oil Filter.....	H-5508	D5C (CRAWLERS) S/N: 8ZS1-UP Hydraulic Oil Filter.....	H-5504
D5B (CRAWLER TRACTORS) w/3306 Eng. Hydraulic Oil Filter.....	H-55320	D5B (CRAWLERS) S/N: 46X1-UP Hydraulic Oil Filter.....	H-5504	Hydraulic Oil Filter.....	H-55270
D5B (CRAWLERS) S/N: 21Y1-557 Hydraulic Oil Filter.....	H-5504	Hydraulic Oil Filter.....	H-5504	D5C (CRAWLERS) S/N: 9DL1-UP Hydraulic Oil Filter.....	H-5504
D5B (CRAWLERS) S/N: 21Y1-UP Hydraulic Oil Filter.....	H-5504	D5B (CRAWLERS) S/N: 47X1-UP Hydraulic Oil Filter.....	H-55270	Hydraulic Oil Filter.....	H-55270
Hydraulic Oil Filter.....	H-5504	Hydraulic Oil Filter.....	H-5508	Hydraulic Oil Filter.....	H-55270
D5B (CRAWLERS) S/N: 21Y558-UP Hydraulic Oil Filter.....	H-5504	Hydraulic Oil Filter.....	H-5504	D5C LGP XL SERIES III (CRAWLERS) S/N: 5HS1-UP Hydraulic Oil Filter.....	HC-5504
D5B (CRAWLERS) S/N: 22X1-UP Hydraulic Oil Filter.....	H-5508	D5B (CRAWLERS) S/N: 48X1-UP Hydraulic Oil Filter.....	H-5508	D5C LGP XL SERIES III (CRAWLERS) S/N: 6ZL1-UP Hydraulic Oil Filter.....	H-5504
Hydraulic Oil Filter.....	H-5504	Hydraulic Oil Filter.....	H-55270	Hydraulic Oil Filter.....	H-55270
D5B (CRAWLERS) S/N: 23X1-UP Hydraulic Oil Filter.....	H-5504	Hydraulic Oil Filter.....	H-5508	D5C LGP XL SERIES III (CRAWLERS) S/N: 7PS1-UP Hydraulic Oil Filter.....	HC-5504
Hydraulic Oil Filter.....	H-5508	D5B (CRAWLERS) S/N: 5LD1-UP Hydraulic Oil Filter.....	H-5504	Hydraulic Oil Filter.....	HC-5504
D5B (CRAWLERS) S/N: 24X1-UP Hydraulic Oil Filter.....	H-5508	Hydraulic Oil Filter.....	H-5508	D5C LGP XL SERIES III (CRAWLERS) S/N: 8ZS1-UP Hydraulic Oil Filter.....	H-55270
Hydraulic Oil Filter.....	H-5504	Hydraulic Oil Filter.....	H-55270	Hydraulic Oil Filter.....	H-5504
D5B (CRAWLERS) S/N: 25X1-UP Hydraulic Oil Filter.....	H-5504	D5B (CRAWLERS) S/N: 8HD1-620 Hydraulic Oil Filter.....	H-55270	D5C LGP XL SERIES III (CRAWLERS) S/N: 9DL1-UP Hydraulic Oil Filter.....	H-55270
Hydraulic Oil Filter.....	H-5508	Hydraulic Oil Filter.....	H-5508	Hydraulic Oil Filter.....	H-5504
D5B (CRAWLERS) S/N: 26X1-826 Hydraulic Oil Filter.....	H-55270	Hydraulic Oil Filter.....	H-5504	D5C LGP XL SERIES III (CRAWLERS) S/N: 7PS1-UP Hydraulic Oil Filter.....	HC-5504
Hydraulic Oil Filter.....	H-5504	D5B (CRAWLERS) S/N: 8MB1-UP Hydraulic Oil Filter.....	H-5508	Hydraulic Oil Filter.....	H-5504
D5B (CRAWLERS) S/N: 26X1-UP Hydraulic Oil Filter.....	H-5504	Hydraulic Oil Filter.....	H-5504	D5C SERIES III (CRAWLERS) S/N: 6CS1-UP Hydraulic Oil Filter.....	HC-5504
Hydraulic Oil Filter.....	H-5508	D5B (CRAWLERS) S/N: 8MB1-UP Hydraulic Oil Filter.....	H-5508	D5C SERIES III (CRAWLERS) S/N: 6ZL1-794 Hydraulic Oil Filter.....	H-5501
D5B (CRAWLERS) S/N: 26X1-UP Hydraulic Oil Filter.....	H-5504	Hydraulic Oil Filter.....	H-55270	Hydraulic Oil Filter.....	H-55270
Hydraulic Oil Filter.....	H-5504	D5C (CRAWLERS) S/N: 3MK1-UP			



ENGINE APPLICATION

MODEL/APPLICATION	SAKURA NO	MODEL/APPLICATION	SAKURA NO	MODEL/APPLICATION	SAKURA NO
CATERPILLAR		CATERPILLAR		CATERPILLAR	
D5C SERIES III (CRAWLERS) S/N: 6ZL795-UP		D5G (CRAWLERS) S/N: WGB1-UP		Hydraulic Oil Filter.....	H-5510
Hydraulic Oil Filter.....	H-5501	Hydraulic Oil Filter.....	HC-5504	D5H (CRAWLERS) S/N: 2SD4079-UP	
Hydraulic Oil Filter.....	H-55270	Hydraulic Oil Filter.....	HC-55220	Hydraulic Oil Filter.....	H-55270
D5C SERIES III (CRAWLERS) S/N: 9DL1-2236		Hydraulic Oil Filter.....	HC-5507	Hydraulic Oil Filter.....	H-5510
Hydraulic Oil Filter.....	H-55270	D5H (CRAWLERS) S/N: 1DD1-3999		Hydraulic Oil Filter.....	H-5504
Hydraulic Oil Filter.....	H-5501	Hydraulic Oil Filter.....	H-55270	D5H (CRAWLERS) S/N: 3MD1-4025	
D5C SERIES III (CRAWLERS) S/N: 9DL2237-UP		Hydraulic Oil Filter.....	H-5504	Hydraulic Oil Filter.....	H-55270
Hydraulic Oil Filter.....	H-55270	D5H (CRAWLERS) S/N: 1DD1-5759		Hydraulic Oil Filter.....	H-5504
Hydraulic Oil Filter.....	H-5501	Hydraulic Oil Filter.....	H-5504	Hydraulic Oil Filter.....	H-5510
D5C SERIES III (CRAWLERS) S/N: 9DL2550-2569		D5H (CRAWLERS) S/N: 1DD4000-UP		D5H (CRAWLERS) S/N: 3MD1-4026	
Hydraulic Oil Filter.....	H-55270	Hydraulic Oil Filter.....	H-5504	Hydraulic Oil Filter.....	H-5510
Hydraulic Oil Filter.....	H-5504	Hydraulic Oil Filter.....	H-55270	Hydraulic Oil Filter.....	H-5504
D5E (CRAWLER TRACTORS) w/3306 Eng.		D5H (CRAWLERS) S/N: 1DD5760-UP		Hydraulic Oil Filter.....	H-5510
Hydraulic Oil Filter.....	H-55320	Hydraulic Oil Filter.....	H-5504	Hydraulic Oil Filter.....	H-55270
D5E (CRAWLERS) S/N: 7KJ1-UP		Hydraulic Oil Filter.....	H-5510	Hydraulic Oil Filter.....	H-5504
Hydraulic Oil Filter.....	H-5508	D5H (CRAWLERS) S/N: 1TD4027-UP		D5H (CRAWLERS) S/N: 3MD4027-UP	
D5E (CRAWLERS) S/N: 9RG1-353		Hydraulic Oil Filter.....	H-55270	Hydraulic Oil Filter.....	H-5504
Hydraulic Oil Filter.....	H-5508	Hydraulic Oil Filter.....	H-5510	Hydraulic Oil Filter.....	H-5510
Hydraulic Oil Filter.....	H-5504	Hydraulic Oil Filter.....	H-5504	D5H (CRAWLERS) S/N: 4KD1-4069	
D5E (CRAWLERS) S/N: 9RG1-UP		D5H (CRAWLERS) S/N: 1WB1-UP		Hydraulic Oil Filter.....	H-55270
Hydraulic Oil Filter.....	H-55270	Hydraulic Oil Filter.....	H-5501	Hydraulic Oil Filter.....	H-5504
Hydraulic Oil Filter.....	H-5504	D5H (CRAWLERS) S/N: 1YD1-4026		Hydraulic Oil Filter.....	H-5510
Hydraulic Oil Filter.....	H-5508	Hydraulic Oil Filter.....	H-5510	Hydraulic Oil Filter.....	H-5504
D5E (CRAWLERS) S/N: 9RG354-UP		Hydraulic Oil Filter.....	H-55270	D5H (CRAWLERS) S/N: 4KD1-4070	
Hydraulic Oil Filter.....	H-5504	D5H (CRAWLERS) S/N: 1YD1-4026		Hydraulic Oil Filter.....	H-5510
D5E DD (CRAWLERS) S/N: 9RG1-UP		D5H (CRAWLERS) S/N: 1YD1-UP		Hydraulic Oil Filter.....	H-5504
Hydraulic Oil Filter.....	H-5508	Hydraulic Oil Filter.....	H-5504	Hydraulic Oil Filter.....	H-5510
Hydraulic Oil Filter.....	H-5504	Hydraulic Oil Filter.....	H-5510	D5H (CRAWLERS) S/N: 4KD4070-UP	
D5G (CRAWLERS) S/N: FDH1-UP		D5H (CRAWLERS) S/N: 2CC1-UP		Hydraulic Oil Filter.....	H-55270
Hydraulic Oil Filter.....	HC-5504	Hydraulic Oil Filter.....	H-5504	Hydraulic Oil Filter.....	H-5504
Hydraulic Oil Filter.....	HC-5507	Hydraulic Oil Filter.....	H-5510	Hydraulic Oil Filter.....	H-5510
Hydraulic Oil Filter.....	HC-55220	D5H (CRAWLERS) S/N: 2EJ1-UP		D5H (CRAWLERS) S/N: 7NC1-3999	
D5G (CRAWLERS) S/N: FDW1-UP		Hydraulic Oil Filter.....	H-5501	Hydraulic Oil Filter.....	H-5504
Hydraulic Oil Filter.....	HC-5507	D5H (CRAWLERS) S/N: 2SD1-4078		Hydraulic Oil Filter.....	H-55270
Hydraulic Oil Filter.....	HC-5504	Hydraulic Oil Filter.....	H-5504	D5H (CRAWLERS) S/N: 7NC1-5499	
Hydraulic Oil Filter.....	HC-55220	Hydraulic Oil Filter.....	H-5510	Hydraulic Oil Filter.....	H-5510
D5G (CRAWLERS) S/N: RKG1-UP		Hydraulic Oil Filter.....	H-55270	Hydraulic Oil Filter.....	H-55270
Hydraulic Oil Filter.....	HC-55220	D5H (CRAWLERS) S/N: 2SD1-UP		Hydraulic Oil Filter.....	H-5504
Hydraulic Oil Filter.....	HC-5504	Hydraulic Oil Filter.....	H-5504	D5H (CRAWLERS) S/N: 7NC4000-UP	
Hydraulic Oil Filter.....	HC-5507				



ENGINE APPLICATION

MODEL/APPLICATION	SAKURA NO	MODEL/APPLICATION	SAKURA NO	MODEL/APPLICATION	SAKURA NO
CATERPILLAR		CATERPILLAR		CATERPILLAR	
D5H (CRAWLERS) S/N: 7NC4000-UP		Hydraulic Oil Filter.....	H-5504	D5H LGP SERIES II (CRAWLERS) S/N: 4KD4070-UP	
Hydraulic Oil Filter.....	H-55270	Hydraulic Oil Filter.....	H-55270	Hydraulic Oil Filter.....	H-5504
Hydraulic Oil Filter.....	H-5504	Hydraulic Oil Filter.....	H-5510	Hydraulic Oil Filter.....	H-55270
D5H (CRAWLERS) S/N: 7NC5500-5524		D5H LGP (CRAWLERS) S/N: 3MD1-UP , T0-2001		D5H LGP SERIES II (CRAWLERS) S/N: 9HC4000-UP	
Hydraulic Oil Filter.....	H-5510	Hydraulic Oil Filter.....	H-5504	Hydraulic Oil Filter.....	H-55270
Hydraulic Oil Filter.....	H-5504	Hydraulic Oil Filter.....	H-5510	Hydraulic Oil Filter.....	H-5504
Hydraulic Oil Filter.....	H-55270	Hydraulic Oil Filter.....	H-55270	D5H SERIES II (CRAWLERS) S/N: 1DD1-5759	
D5H (CRAWLERS) S/N: 7NC5525-UP		D5H LGP (CRAWLERS) S/N: 1DD1-3999		Hydraulic Oil Filter.....	H-5510
Hydraulic Oil Filter.....	H-5504	Hydraulic Oil Filter.....	H-5504	Hydraulic Oil Filter.....	H-5504
Hydraulic Oil Filter.....	H-55270	Hydraulic Oil Filter.....	H-55270	D5H SERIES II (CRAWLERS) S/N: 1DD5760-UP	
Hydraulic Oil Filter.....	H-5510	D5H LGP (CRAWLERS) S/N: 1YD1-UP		Hydraulic Oil Filter.....	H-5510
D5H (CRAWLERS) S/N: 8RC1-3999		Hydraulic Oil Filter.....	H-5504	Hydraulic Oil Filter.....	H-5504
Hydraulic Oil Filter.....	H-55270	Hydraulic Oil Filter.....	H-55270	D5H SERIES II (CRAWLERS) S/N: 2EJ1-UP	
Hydraulic Oil Filter.....	H-5504	Hydraulic Oil Filter.....	H-5510	Hydraulic Oil Filter.....	H-5501
D5H (CRAWLERS) S/N: 8RC1-5846		D5H LGP (CRAWLERS) S/N: 2SD1-UP		D5H SERIES II (CRAWLERS) S/N: 8RC1-5846	
Hydraulic Oil Filter.....	H-5504	Hydraulic Oil Filter.....	H-5510	Hydraulic Oil Filter.....	H-5504
Hydraulic Oil Filter.....	H-5510	Hydraulic Oil Filter.....	H-5504	Hydraulic Oil Filter.....	H-5510
D5H (CRAWLERS) S/N: 8RC4000-UP		D5H LGP (CRAWLERS) S/N: 4KD1-UP		D5H SERIES II (CRAWLERS) S/N: 8RC5847-UP	
Hydraulic Oil Filter.....	H-55270	Hydraulic Oil Filter.....	H-5504	Hydraulic Oil Filter.....	H-5510
Hydraulic Oil Filter.....	H-5504	Hydraulic Oil Filter.....	H-5510	Hydraulic Oil Filter.....	H-5504
D5H (CRAWLERS) S/N: 8RC5847-UP		D5H LGP (CRAWLERS) S/N: 7NC1-3999		D5H SERIES II (CRAWLERS) S/N: 8RJ1-UP	
Hydraulic Oil Filter.....	H-5504	Hydraulic Oil Filter.....	H-55270	Hydraulic Oil Filter.....	H-5504
Hydraulic Oil Filter.....	H-5510	Hydraulic Oil Filter.....	H-5504	Hydraulic Oil Filter.....	H-5510
D5H (CRAWLERS) S/N: 9HC1-3999		D5H LGP (CRAWLERS) S/N: 8RC1-3999		D5H SERIES II (CRAWLERS) S/N: 9HC1-5499	
Hydraulic Oil Filter.....	H-55270	Hydraulic Oil Filter.....	H-5504	Hydraulic Oil Filter.....	H-5504
Hydraulic Oil Filter.....	H-5504	Hydraulic Oil Filter.....	H-55270	Hydraulic Oil Filter.....	H-55270
D5H (CRAWLERS) S/N: 9HC1-5499		D5H LGP (CRAWLERS) S/N: 9HC1-3999		Hydraulic Oil Filter.....	H-5510
Hydraulic Oil Filter.....	H-5504	Hydraulic Oil Filter.....	H-5504	Hydraulic Oil Filter.....	H-55270
Hydraulic Oil Filter.....	H-5510	Hydraulic Oil Filter.....	H-55270	Hydraulic Oil Filter.....	H-5510
Hydraulic Oil Filter.....	H-55270	D5H LGP SERIES II (CRAWLERS) S/N: 1DD4000-UP		D5H SERIES II (CRAWLERS) S/N: 9HC5500-5518	
D5H (CRAWLERS) S/N: 9HC1-UP		Hydraulic Oil Filter.....	H-5504	Hydraulic Oil Filter.....	H-5510
Hydraulic Oil Filter.....	H-5504	Hydraulic Oil Filter.....	H-55270	Hydraulic Oil Filter.....	H-5504
D5H (CRAWLERS) S/N: 9HC4000-UP		D5H LGP SERIES II (CRAWLERS) S/N: 2SD4079-UP		Hydraulic Oil Filter.....	H-55270
Hydraulic Oil Filter.....	H-55270	Hydraulic Oil Filter.....	H-5504	Hydraulic Oil Filter.....	H-5504
Hydraulic Oil Filter.....	H-5504	Hydraulic Oil Filter.....	H-55270	Hydraulic Oil Filter.....	H-5510
D5H (CRAWLERS) S/N: 9HC5500-5518		Hydraulic Oil Filter.....	H-5510	D5H TSK (CRAWLERS) S/N: 7EG1-UP	
Hydraulic Oil Filter.....	H-5504	D5H LGP SERIES II (CRAWLERS) S/N: 3MD4026-UP		Hydraulic Oil Filter.....	H-5510
Hydraulic Oil Filter.....	H-5510	Hydraulic Oil Filter.....	H-5510	D5H XL (CRAWLERS) S/N: 8RJ1-UP	
Hydraulic Oil Filter.....	H-55270	Hydraulic Oil Filter.....	H-5504	Hydraulic Oil Filter.....	H-5504
D5H (CRAWLERS) S/N: 9HC5519-UP		Hydraulic Oil Filter.....	H-55270	Hydraulic Oil Filter.....	H-55270
Hydraulic Oil Filter.....	H-5504	D5H LGP SERIES II (CRAWLERS) S/N: 8R1-UP			
Hydraulic Oil Filter.....	H-5510	Hydraulic Oil Filter.....	H-5504		
Hydraulic Oil Filter.....	H-55270	Hydraulic Oil Filter.....	H-55270		



ENGINE APPLICATION

MODEL/APPLICATION	SAKURA NO	MODEL/APPLICATION	SAKURA NO	MODEL/APPLICATION	SAKURA NO
CATERPILLAR		CATERPILLAR		CATERPILLAR	
D5H XL (CRAWLERS) S/N: 8RJ1-UP		D5M (CRAWLERS) S/N: 6GN1-UP		D5M XL (CRAWLERS) S/N: 6AS1-UP	
D5M (CRAWLERS) S/N: 3CR1033-UP		Hydraulic Oil Filter..... H-5504		Hydraulic Oil Filter..... H-55270	
Hydraulic Oil Filter..... H-5526		Hydraulic Oil Filter..... H-55270		Hydraulic Oil Filter..... H-5526	
Hydraulic Oil Filter..... H-5504		Hydraulic Oil Filter..... H-5526		Hydraulic Oil Filter..... H-5504	
Hydraulic Oil Filter..... H-55270		D5M LGP (CRAWLERS) S/N: 4J51-UP		D5N (CRAWLER TRACTORS) w/3126B Eng.	
Hydraulic Oil Filter..... H-55280		Hydraulic Oil Filter..... H-5504		Hydraulic Oil Filter..... HC-55280	
D5M (CRAWLERS) S/N: 3CR1-1032		Hydraulic Oil Filter..... H-55270		D5N (DOZERS) S/N: AGG1-195-UP	
Hydraulic Oil Filter..... H-55270		Hydraulic Oil Filter..... HC-5507		Hydraulic Oil Filter..... HC-55220	
D5M (CRAWLERS) S/N: 3CR1-UP		Hydraulic Oil Filter..... HC-55220		Hydraulic Oil Filter..... H-5510	
Hydraulic Oil Filter..... H-5526		D5M LGP (CRAWLERS) S/N: 5E51-UP		Hydraulic Oil Filter..... H-5526	
Hydraulic Oil Filter..... H-5504		Hydraulic Oil Filter..... H-55270		Hydraulic Oil Filter..... H-55280	
Hydraulic Oil Filter..... H-55270		Hydraulic Oil Filter..... H-5001		Hydraulic Oil Filter..... HC-5507	
D5M (CRAWLERS) S/N: 3DR1-423		Hydraulic Oil Filter..... H-5504		D5N (DOZERS) S/N: AGG196-331-UP	
Hydraulic Oil Filter..... H-55270		Hydraulic Oil Filter..... H-5526		Hydraulic Oil Filter..... H-5510	
D5M (CRAWLERS) S/N: 3DR424-UP		D5M LGP (CRAWLERS) S/N: 5F51-UP		Hydraulic Oil Filter..... H-5526	
Hydraulic Oil Filter..... H-55280		Hydraulic Oil Filter..... HC-55220		Hydraulic Oil Filter..... HC-55220	
Hydraulic Oil Filter..... H-5504		Hydraulic Oil Filter..... H-55270		Hydraulic Oil Filter..... HC-5507	
Hydraulic Oil Filter..... H-55270		Hydraulic Oil Filter..... HC-5507		D5N (DOZERS) S/N: AGG332-UP	
Hydraulic Oil Filter..... H-5526		Hydraulic Oil Filter..... H-5504		Hydraulic Oil Filter..... H-5526	
D5M (CRAWLERS) S/N: 4BR1-532		D5M LGP (CRAWLERS) S/N: 6AS1-UP		Hydraulic Oil Filter..... H-55280	
Hydraulic Oil Filter..... H-55270		Hydraulic Oil Filter..... H-55270		Hydraulic Oil Filter..... H-5510	
D5M (CRAWLERS) S/N: 4BR1-UP		Hydraulic Oil Filter..... H-5504		D5N (DOZERS) S/N: AKD1-315-UP	
Hydraulic Oil Filter..... H-55270		Hydraulic Oil Filter..... H-5526		Hydraulic Oil Filter..... H-55280	
Hydraulic Oil Filter..... H-5526		Hydraulic Oil Filter..... H-5504		Hydraulic Oil Filter..... H-5510	
Hydraulic Oil Filter..... H-5504		D5M LGP (CRAWLERS) S/N: 6GN1-UP		D5N (DOZERS) S/N: AKD316-411-UP	
D5M (CRAWLERS) S/N: 4BR533-UP		Hydraulic Oil Filter..... H-55270		Hydraulic Oil Filter..... H-5510	
Hydraulic Oil Filter..... H-5526		Hydraulic Oil Filter..... H-5526		Hydraulic Oil Filter..... HC-55220	
Hydraulic Oil Filter..... H-5504		Hydraulic Oil Filter..... H-5504		Hydraulic Oil Filter..... HC-5507	
Hydraulic Oil Filter..... H-55280		D5M LGPXL (CRAWLERS) CAT 3116		Hydraulic Oil Filter..... HC-55220	
Hydraulic Oil Filter..... H-55270		Hydraulic Oil Filter..... HC-5507		Hydraulic Oil Filter..... HC-5507	
D5M (CRAWLERS) S/N: 6DR1-UP		Hydraulic Oil Filter..... H-5504		Hydraulic Oil Filter..... H-5526	
Hydraulic Oil Filter..... H-55270		D5M XL (CRAWLERS) S/N: 4J51-UP		Hydraulic Oil Filter..... H-5510	
Hydraulic Oil Filter..... H-5526		Hydraulic Oil Filter..... HC-55220		D5N (DOZERS) S/N: AKD412-UP	
Hydraulic Oil Filter..... H-5504		Hydraulic Oil Filter..... H-5504		Hydraulic Oil Filter..... H-5526	
D5M (CRAWLERS) S/N: 6GN1-1334		Hydraulic Oil Filter..... HC-5507		Hydraulic Oil Filter..... H-55280	
Hydraulic Oil Filter..... H-55270		Hydraulic Oil Filter..... H-55270		Hydraulic Oil Filter..... H-5510	
D5M (CRAWLERS) S/N: 6GN1335-UP		D5M XL (CRAWLERS) S/N: 5E51-UP		D5 TURBO (CRAWLERS)	
Hydraulic Oil Filter..... H-5526		Hydraulic Oil Filter..... H-55270		Hydraulic Oil Filter..... H-5504	
Hydraulic Oil Filter..... H-5504		Hydraulic Oil Filter..... H-5526		D6 (CRAWLERS) S/N: 10K2691-UP	
Hydraulic Oil Filter..... H-55270		Hydraulic Oil Filter..... H-5504		Hydraulic Oil Filter..... H-5503	
Hydraulic Oil Filter..... H-55280		D5M XL (CRAWLERS) S/N: 5F51-UP		D6 (CRAWLERS) S/N: 1Y1-UP	
		Hydraulic Oil Filter..... H-55270		Hydraulic Oil Filter..... H-5503	
		Hydraulic Oil Filter..... HC-55220			
		Hydraulic Oil Filter..... HC-5507			
		Hydraulic Oil Filter..... H-5504			



ENGINE APPLICATION

MODEL/APPLICATION	SAKURA NO	MODEL/APPLICATION	SAKURA NO	MODEL/APPLICATION	SAKURA NO
CATERPILLAR		CATERPILLAR		CATERPILLAR	
D6 (CRAWLERS) S/N: 33X1-UP		D6C (CRAWLERS) S/N: 3X-UP		Hydraulic Oil Filter.....	H-5503
Hydraulic Oil Filter.....	H-5508	Hydraulic Oil Filter.....	H-5503	D6D (CRAWLERS) S/N: 19X767-UP	
Hydraulic Oil Filter.....	H-5503	D6C (CRAWLERS) S/N: 4X-UP		Hydraulic Oil Filter.....	H-5508
D6 (CRAWLERS) S/N: 74A1-1751		Hydraulic Oil Filter.....	H-5503	Hydraulic Oil Filter.....	H-5503
Hydraulic Oil Filter.....	H-5504	D6C (CRAWLERS) S/N: 5X-UP		D6D (CRAWLERS) S/N: 1Y460-UP	
D6 (CRAWLERS) S/N: 75W1-UP		Hydraulic Oil Filter.....	H-5503	Hydraulic Oil Filter.....	H-5503
Hydraulic Oil Filter.....	H-5503	D6C (CRAWLERS) S/N: 6X-UP		D6D (CRAWLERS) S/N: 20X3042-UP	
Hydraulic Oil Filter.....	H-5508	Hydraulic Oil Filter.....	H-5503	Hydraulic Oil Filter.....	H-5508
D6 (CRAWLERS) S/N: 76A1-2891		D6C (CRAWLERS) S/N: 69U1-UP		Hydraulic Oil Filter.....	H-5503
Hydraulic Oil Filter.....	H-5504	Hydraulic Oil Filter.....	H-5503	D6D (CRAWLERS) S/N: 30X1-UP	
D6 (CRAWLERS) S/N: 99J1593-UP		D6C (CRAWLERS) S/N: 74A1-1751		Hydraulic Oil Filter.....	H-5508
Hydraulic Oil Filter.....	H-5503	Hydraulic Oil Filter.....	H-5504	Hydraulic Oil Filter.....	H-5503
D6B (CRAWLERS) S/N: 37A1-UP		D6C (CRAWLERS) S/N: 74A1752-UP		Hydraulic Oil Filter.....	H-5526
Hydraulic Oil Filter.....	H-5504	Hydraulic Oil Filter.....	H-5504	Hydraulic Oil Filter.....	H-55280
D6B (CRAWLERS) S/N: 44A1-UP		D6C (CRAWLERS) S/N: 76A1-2891		D6D (CRAWLERS) S/N: 30X2070-UP	
Hydraulic Oil Filter.....	H-5504	Hydraulic Oil Filter.....	H-5504	Hydraulic Oil Filter.....	H-5508
D6B (CRAWLERS) S/N: 56A1-UP		D6C (CRAWLERS) S/N: 76A2892-UP		Hydraulic Oil Filter.....	H-5503
Hydraulic Oil Filter.....	H-5504	Hydraulic Oil Filter.....	H-5503	D6D (CRAWLERS) S/N: 31X1497-UP	
D6B (CRAWLERS) S/N: 57A1-UP		D6C (CRAWLERS) S/N: 82A1-UP		Hydraulic Oil Filter.....	H-5508
Hydraulic Oil Filter.....	H-5504	Hydraulic Oil Filter.....	H-5508	Hydraulic Oil Filter.....	H-5503
D6C (CRAWLERS) S/N: 10K11940-UP		D6C (CRAWLERS) S/N: 99J1-1550		D6D (CRAWLERS) S/N: 32X1181-UP	
Hydraulic Oil Filter.....	H-5503	Hydraulic Oil Filter.....	H-5503	Hydraulic Oil Filter.....	H-5508
Hydraulic Oil Filter.....	H-5508	D6C (CRAWLERS) S/N: 99J1551-1592		Hydraulic Oil Filter.....	H-5503
D6C (CRAWLERS) S/N: 10K1-5984		Hydraulic Oil Filter.....	H-5503	D6D (CRAWLERS) S/N: 36C100-UP	
Hydraulic Oil Filter.....	H-5503	D6C (CRAWLERS) S/N: 99J1593-1753		Hydraulic Oil Filter.....	H-5503
D6C (CRAWLERS) S/N: 10K5985-6290		Hydraulic Oil Filter.....	H-5503	Hydraulic Oil Filter.....	H-5508
Hydraulic Oil Filter.....	H-5503	D6C (CRAWLERS) S/N: 99J1754-2534		Hydraulic Oil Filter.....	H-5526
D6C (CRAWLERS) S/N: 10K5985-7952		Hydraulic Oil Filter.....	H-5503	Hydraulic Oil Filter.....	H-55280
Hydraulic Oil Filter.....	H-5503	D6C (CRAWLERS) S/N: 99J2535-UP		D6D (CRAWLERS) S/N: 37C200-UP	
D6C (CRAWLERS) S/N: 10K7953-11939		Hydraulic Oil Filter.....	H-5503	Hydraulic Oil Filter.....	H-5503
Hydraulic Oil Filter.....	H-5503	D6D (CRAWLERS) S/N: 19B400-UP		Hydraulic Oil Filter.....	H-5526
D6C (CRAWLERS) S/N: 17R1284-UP		Hydraulic Oil Filter.....	H-55270	Hydraulic Oil Filter.....	H-5508
Hydraulic Oil Filter.....	H-5503	D6C (CRAWLERS) S/N: 17R465-1283		D6D (CRAWLERS) S/N: 38C100-UP	
D6C (CRAWLERS) S/N: 17R465-1283		Hydraulic Oil Filter.....	H-5504	Hydraulic Oil Filter.....	H-5503
Hydraulic Oil Filter.....	H-5503	Hydraulic Oil Filter.....	H-55280	Hydraulic Oil Filter.....	H-5526
D6C (CRAWLERS) S/N: 17R465-1283		Hydraulic Oil Filter.....	H-5526	Hydraulic Oil Filter.....	H-5504
Hydraulic Oil Filter.....	H-5503	Hydraulic Oil Filter.....	H-5526	Hydraulic Oil Filter.....	H-55270



ENGINE APPLICATION

MODEL/APPLICATION	SAKURA NO	MODEL/APPLICATION	SAKURA NO	MODEL/APPLICATION	SAKURA NO
CATERPILLAR		CATERPILLAR		CATERPILLAR	
D6D (CRAWLERS) S/N: 38C100-UP		D6E (CRAWLERS) S/N: 2M31-UP		Hydraulic Oil Filter.....	H-5526
Hydraulic Oil Filter.....	H-55280	Hydraulic Oil Filter.....	H-5503	Hydraulic Oil Filter.....	HC-5511
D6D (CRAWLERS) S/N: 3X1-UP		Hydraulic Oil Filter.....	H-55280	Hydraulic Oil Filter.....	H-5503
Hydraulic Oil Filter.....	H-5503	Hydraulic Oil Filter.....	H-5508	Hydraulic Oil Filter.....	H-5510
Hydraulic Oil Filter.....	H-5508	Hydraulic Oil Filter.....	H-5526	Hydraulic Oil Filter.....	H-55280
D6D (CRAWLERS) S/N: 4X1-UP		D6E SR (CRAWLERS) S/N: 8F31-UP		D6H (CRAWLERS) S/N: 1FJ4000-5499	
Hydraulic Oil Filter.....	H-5508	Hydraulic Oil Filter.....	H-5508	Hydraulic Oil Filter.....	H-5510
Hydraulic Oil Filter.....	H-5503	D6F SR (CRAWLERS) CAT 3306T (S/N: 5FR1-UP)		Hydraulic Oil Filter.....	H-5503
D6D (CRAWLERS) S/N: 5X1-UP		Hydraulic Oil Filter.....	HC-5512	D6H (CRAWLERS) S/N: 1FJ482-3999	
Hydraulic Oil Filter.....	H-5503	Hydraulic Oil Filter.....	H-55280	Hydraulic Oil Filter.....	H-5510
Hydraulic Oil Filter.....	H-55280	Hydraulic Oil Filter.....	HC-5503	Hydraulic Oil Filter.....	H-5503
Hydraulic Oil Filter.....	H-5526	Hydraulic Oil Filter.....	HC-5506	D6H (CRAWLERS) S/N: 1FJ5500-5540	
Hydraulic Oil Filter.....	H-5526	Hydraulic Oil Filter.....	H-5503	Hydraulic Oil Filter.....	H-5503
D6D (CRAWLERS) S/N: 5YB800-UP		Hydraulic Oil Filter.....	H-5526	Hydraulic Oil Filter.....	H-5510
Hydraulic Oil Filter.....	H-5503	D6G (CRAWLERS) CAT 3306T (S/N: 3SR1-UP)		D6H (CRAWLERS) S/N: 1FJ5541-5541	
Hydraulic Oil Filter.....	H-55280	Hydraulic Oil Filter.....	H-5526	Hydraulic Oil Filter.....	H-5510
Hydraulic Oil Filter.....	H-55280	Hydraulic Oil Filter.....	HC-5512	Hydraulic Oil Filter.....	H-5503
Hydraulic Oil Filter.....	H-5526	Hydraulic Oil Filter.....	H-55280	D6H (CRAWLERS) S/N: 1FJ5542-UP	
D6D (CRAWLERS) S/N: 6H1-UP		Hydraulic Oil Filter.....	HC-5506	Hydraulic Oil Filter.....	H-5503
Hydraulic Oil Filter.....	H-55280	Hydraulic Oil Filter.....	H-5503	Hydraulic Oil Filter.....	H-5510
Hydraulic Oil Filter.....	H-5508	Hydraulic Oil Filter.....	HC-5503	D6H (CRAWLERS) S/N: 1KD1-5499	
Hydraulic Oil Filter.....	H-5526	Hydraulic Oil Filter.....	H-5503	Hydraulic Oil Filter.....	H-5503
Hydraulic Oil Filter.....	H-5503	D6G II (CRAWLERS) CAT S/N: 10Z1-UP		Hydraulic Oil Filter.....	HC-55310
D6D (CRAWLERS) S/N: 6X1-UP		Hydraulic Oil Filter.....	HC-5503	D6H (CRAWLERS) S/N: 1KD1-UP	
Hydraulic Oil Filter.....	H-5503	Hydraulic Oil Filter.....	H-55280	Hydraulic Oil Filter.....	H-55280
Hydraulic Oil Filter.....	H-5508	Hydraulic Oil Filter.....	HC-5506	Hydraulic Oil Filter.....	HC-55310
Hydraulic Oil Filter.....	H-5526	Hydraulic Oil Filter.....	H-5526	Hydraulic Oil Filter.....	HC-5511
Hydraulic Oil Filter.....	H-5503	Hydraulic Oil Filter.....	HC-5512	Hydraulic Oil Filter.....	H-5503
D6D (CRAWLERS) S/N: 74W2561-UP		D6G II (CRAWLERS) CAT S/N: C6G1000-UP		Hydraulic Oil Filter.....	H-5526
Hydraulic Oil Filter.....	H-5503	Hydraulic Oil Filter.....	HC-5512	D6H (CRAWLERS) S/N: 1KD4074-UP	
Hydraulic Oil Filter.....	H-5508	Hydraulic Oil Filter.....	HC-5506	Hydraulic Oil Filter.....	H-5526
Hydraulic Oil Filter.....	H-5526	Hydraulic Oil Filter.....	H-55280	Hydraulic Oil Filter.....	H-5503
Hydraulic Oil Filter.....	H-5526	Hydraulic Oil Filter.....	H-5526	Hydraulic Oil Filter.....	H-55280
D6D (CRAWLERS) S/N: 75W1-UP		Hydraulic Oil Filter.....	H-5526	D6H (CRAWLERS) S/N: 1KD5500-UP	
Hydraulic Oil Filter.....	H-5503	Hydraulic Oil Filter.....	HC-5503	Hydraulic Oil Filter.....	H-5503
Hydraulic Oil Filter.....	H-5508	D6G SR (TRACTORS) S/N: 2M3,3SR-UP		Hydraulic Oil Filter.....	H-55280
Hydraulic Oil Filter.....	H-5526	Hydraulic Oil Filter.....	HC-5503	D6H (CRAWLERS) S/N: 2KD1-UP	
Hydraulic Oil Filter.....	H-55280	Hydraulic Oil Filter.....	H-5503	Hydraulic Oil Filter.....	HC-55310
D6D (CRAWLERS) S/N: 7YK1-UP		Hydraulic Oil Filter.....	HC-5506	Hydraulic Oil Filter.....	HC-5511
Hydraulic Oil Filter.....	H-5503	D6G (CRAWLERS) S/N: 2M3,3SR-UP		Hydraulic Oil Filter.....	H-5503
Hydraulic Oil Filter.....	H-5508	Hydraulic Oil Filter.....	H-5526	Hydraulic Oil Filter.....	H-55280
Hydraulic Oil Filter.....	H-5526	Hydraulic Oil Filter.....	H-5526	D6H (CRAWLERS) S/N: 1KD5500-UP	
Hydraulic Oil Filter.....	H-55280	Hydraulic Oil Filter.....	HC-5503	Hydraulic Oil Filter.....	H-5503
D6D (CRAWLERS) S/N: 9FK1-UP		D6H (CRAWLERS) S/N: 1F31-481		Hydraulic Oil Filter.....	H-55280
Hydraulic Oil Filter.....	H-5503	Hydraulic Oil Filter.....	H-5503	D6H (CRAWLERS) S/N: 2KD1-UP	
Hydraulic Oil Filter.....	H-5508	Hydraulic Oil Filter.....	H-5526	Hydraulic Oil Filter.....	HC-55310
Hydraulic Oil Filter.....	H-5526	D6H (CRAWLERS) S/N: 1F31-481		Hydraulic Oil Filter.....	HC-5511
Hydraulic Oil Filter.....	H-55280	Hydraulic Oil Filter.....	H-5503	Hydraulic Oil Filter.....	H-5526
D6E (CRAWLERS) S/N: 2M31158-2653		Hydraulic Oil Filter.....	H-5503	Hydraulic Oil Filter.....	H-5503
Hydraulic Oil Filter.....	H-5503	D6H (CRAWLERS) S/N: 1F31-UP		Hydraulic Oil Filter.....	H-55280
Hydraulic Oil Filter.....	H-5508	Hydraulic Oil Filter.....	H-5503		
Hydraulic Oil Filter.....	H-5526				
Hydraulic Oil Filter.....	H-55280				



ENGINE APPLICATION

MODEL/APPLICATION	SAKURA NO	MODEL/APPLICATION	SAKURA NO	MODEL/APPLICATION	SAKURA NO
CATERPILLAR		CATERPILLAR		CATERPILLAR	
D6H (CRAWLERS) S/N: 2KD4033-UP		Hydraulic Oil Filter.....	HC-5511	D6H (CRAWLERS) S/N: 3ZF4442-5499	
Hydraulic Oil Filter.....	H-55280	Hydraulic Oil Filter.....	H-55280	Hydraulic Oil Filter.....	HC-55290
Hydraulic Oil Filter.....	H-5526	Hydraulic Oil Filter.....	H-5526	Hydraulic Oil Filter.....	H-5503
Hydraulic Oil Filter.....	H-5503	D6H (CRAWLERS) S/N: 3YG4255-4284		Hydraulic Oil Filter.....	H-5510
Hydraulic Oil Filter.....	H-5510	Hydraulic Oil Filter.....	HC-55290	Hydraulic Oil Filter.....	HC-5511
D6H (CRAWLERS) S/N: 2KD5500-UP		Hydraulic Oil Filter.....	H-5526	Hydraulic Oil Filter.....	H-55280
Hydraulic Oil Filter.....	H-5503	Hydraulic Oil Filter.....	H-5510	Hydraulic Oil Filter.....	H-5526
D6H (CRAWLERS) S/N: 2TG1-3999		Hydraulic Oil Filter.....	HC-5511	D6H (CRAWLERS) S/N: 3ZF5500-5717	
Hydraulic Oil Filter.....	H-55280	Hydraulic Oil Filter.....	HC-55290	Hydraulic Oil Filter.....	HC-5511
Hydraulic Oil Filter.....	H-5503	Hydraulic Oil Filter.....	H-5526	Hydraulic Oil Filter.....	H-5526
Hydraulic Oil Filter.....	HC-5511	Hydraulic Oil Filter.....	H-5503	Hydraulic Oil Filter.....	H-5510
Hydraulic Oil Filter.....	H-5526	Hydraulic Oil Filter.....	H-5510	Hydraulic Oil Filter.....	HC-55290
Hydraulic Oil Filter.....	HC-55310	Hydraulic Oil Filter.....	H-5503	Hydraulic Oil Filter.....	H-55280
D6H (CRAWLERS) S/N: 2TG4000-UP		Hydraulic Oil Filter.....	H-5510	Hydraulic Oil Filter.....	H-5503
Hydraulic Oil Filter.....	H-5503	D6H (CRAWLERS) S/N: 3YG5500-5733		D6H (CRAWLERS) S/N: 3ZF5718-UP	
Hydraulic Oil Filter.....	H-55280	Hydraulic Oil Filter.....	HC-5511	Hydraulic Oil Filter.....	H-55280
Hydraulic Oil Filter.....	H-5510	Hydraulic Oil Filter.....	HC-55290	Hydraulic Oil Filter.....	H-5526
Hydraulic Oil Filter.....	H-5526	Hydraulic Oil Filter.....	H-5526	Hydraulic Oil Filter.....	H-5510
D6H (CRAWLERS) S/N: 3ED1-4082		Hydraulic Oil Filter.....	H-5503	Hydraulic Oil Filter.....	HC-5511
Hydraulic Oil Filter.....	H-5526	Hydraulic Oil Filter.....	H-5510	Hydraulic Oil Filter.....	H-5503
Hydraulic Oil Filter.....	HC-5511	Hydraulic Oil Filter.....	H-5526	Hydraulic Oil Filter.....	H-5526
Hydraulic Oil Filter.....	H-5503	Hydraulic Oil Filter.....	H-5510	Hydraulic Oil Filter.....	HC-5511
Hydraulic Oil Filter.....	H-55280	Hydraulic Oil Filter.....	H-5503	Hydraulic Oil Filter.....	H-5503
Hydraulic Oil Filter.....	HC-55310	Hydraulic Oil Filter.....	H-5510	D6H (CRAWLERS) S/N: 4GG1-UP	
D6H (CRAWLERS) S/N: 3ED4083-UP		Hydraulic Oil Filter.....	H-5526	Hydraulic Oil Filter.....	H-55280
Hydraulic Oil Filter.....	H-55280	Hydraulic Oil Filter.....	HC-5511	Hydraulic Oil Filter.....	H-5503
Hydraulic Oil Filter.....	H-5526	Hydraulic Oil Filter.....	H-5526	Hydraulic Oil Filter.....	H-5510
Hydraulic Oil Filter.....	H-5503	Hydraulic Oil Filter.....	H-5510	Hydraulic Oil Filter.....	H-5526
Hydraulic Oil Filter.....	H-5510	Hydraulic Oil Filter.....	H-5503	Hydraulic Oil Filter.....	HC-5511
D6H (CRAWLERS) S/N: 3YG1-3999		Hydraulic Oil Filter.....	H-55280	D6H (CRAWLERS) S/N: 4LG00603-UP	
Hydraulic Oil Filter.....	H-5526	Hydraulic Oil Filter.....	H-5526	Hydraulic Oil Filter.....	HC-55310
Hydraulic Oil Filter.....	H-55280	Hydraulic Oil Filter.....	H-5510	Hydraulic Oil Filter.....	H-5503
Hydraulic Oil Filter.....	H-5503	Hydraulic Oil Filter.....	H-5526	D6H (CRAWLERS) S/N: 4LG1-3999	
Hydraulic Oil Filter.....	HC-5511	Hydraulic Oil Filter.....	H-5510	Hydraulic Oil Filter.....	H-55280
Hydraulic Oil Filter.....	H-5510	Hydraulic Oil Filter.....	H-5503	Hydraulic Oil Filter.....	H-5503
D6H (CRAWLERS) S/N: 3YG1-4254		Hydraulic Oil Filter.....	H-5526	Hydraulic Oil Filter.....	H-5510
Hydraulic Oil Filter.....	H-55280	Hydraulic Oil Filter.....	H-5510	Hydraulic Oil Filter.....	H-5526
Hydraulic Oil Filter.....	H-5526	Hydraulic Oil Filter.....	HC-5511	Hydraulic Oil Filter.....	HC-5511
D6H (CRAWLERS) S/N: 3YG1-UP		Hydraulic Oil Filter.....	H-5526	D6H (CRAWLERS) S/N: 4LG4000-UP	
Hydraulic Oil Filter.....	H-5503	Hydraulic Oil Filter.....	H-5526	Hydraulic Oil Filter.....	H-55280
Hydraulic Oil Filter.....	H-5510	Hydraulic Oil Filter.....	H-5503	Hydraulic Oil Filter.....	H-5526
D6H (CRAWLERS) S/N: 3YG4000-UP		Hydraulic Oil Filter.....	HC-5511	Hydraulic Oil Filter.....	H-5510
Hydraulic Oil Filter.....	H-5510	Hydraulic Oil Filter.....	H-5526	Hydraulic Oil Filter.....	H-5503
Hydraulic Oil Filter.....	H-5503	D6H (CRAWLERS) S/N: 3ZF4383-4441		D6H (CRAWLERS) S/N: 4RC1050-2444	
Hydraulic Oil Filter.....	H-5503	Hydraulic Oil Filter.....	HC-55290	Hydraulic Oil Filter.....	H-5526
D6H (CRAWLERS) S/N: 3YG4000-UP		Hydraulic Oil Filter.....	H-5526	Hydraulic Oil Filter.....	HC-55310
Hydraulic Oil Filter.....	H-5510	Hydraulic Oil Filter.....	H-5510	Hydraulic Oil Filter.....	H-5510
Hydraulic Oil Filter.....	H-5503	Hydraulic Oil Filter.....	HC-5511	Hydraulic Oil Filter.....	H-55280
Hydraulic Oil Filter.....	H-5503	Hydraulic Oil Filter.....	H-55280		



ENGINE APPLICATION

MODEL/APPLICATION	SAKURA NO
CATERPILLAR	
D6H (CRAWLERS) S/N: 4RC1-1049	
Hydraulic Oil Filter.....	HC-55310
Hydraulic Oil Filter.....	H-5510
D6H (CRAWLERS) S/N: 4RC1-2444	
Hydraulic Oil Filter.....	HC-55310
Hydraulic Oil Filter.....	H-5503
D6H (CRAWLERS) S/N: 4RC2445-2550-UP	
Hydraulic Oil Filter.....	H-5526
Hydraulic Oil Filter.....	HC-55310
Hydraulic Oil Filter.....	H-5510
Hydraulic Oil Filter.....	H-55280
D6H (CRAWLERS) S/N: 4RC2445-3999	
Hydraulic Oil Filter.....	H-5503
D6H (CRAWLERS) S/N: 4RC2551-4050	
Hydraulic Oil Filter.....	H-5510
Hydraulic Oil Filter.....	H-55280
Hydraulic Oil Filter.....	H-5526
Hydraulic Oil Filter.....	HC-55310
D6H (CRAWLERS) S/N: 4RC4000-UP	
Hydraulic Oil Filter.....	H-5510
Hydraulic Oil Filter.....	H-5503
Hydraulic Oil Filter.....	H-5526
Hydraulic Oil Filter.....	H-55280
D6H (CRAWLERS) S/N: 4RC4051-4217	
Hydraulic Oil Filter.....	H-55280
Hydraulic Oil Filter.....	H-5510
Hydraulic Oil Filter.....	H-5526
Hydraulic Oil Filter.....	HC-55310
Hydraulic Oil Filter.....	H-5503
D6H (CRAWLERS) S/N: 4RC4218-4302	
Hydraulic Oil Filter.....	HC-55310
Hydraulic Oil Filter.....	H-5526
Hydraulic Oil Filter.....	H-5510
Hydraulic Oil Filter.....	H-55280
D6H (CRAWLERS) S/N: 4RC4303-5499	
Hydraulic Oil Filter.....	H-55280
Hydraulic Oil Filter.....	HC-55310
Hydraulic Oil Filter.....	H-5526
Hydraulic Oil Filter.....	H-5510
Hydraulic Oil Filter.....	H-5503
D6H (CRAWLERS) S/N: 4RC5500-UP	
Hydraulic Oil Filter.....	H-55280
Hydraulic Oil Filter.....	H-5510
Hydraulic Oil Filter.....	H-5503

MODEL/APPLICATION	SAKURA NO
CATERPILLAR	
Hydraulic Oil Filter.....	HC-55310
Hydraulic Oil Filter.....	H-5526
D6H (CRAWLERS) S/N: 4RD1-3999	
Hydraulic Oil Filter.....	H-55280
Hydraulic Oil Filter.....	H-5526
Hydraulic Oil Filter.....	HC-55310
Hydraulic Oil Filter.....	HC-5511
Hydraulic Oil Filter.....	H-5510
Hydraulic Oil Filter.....	H-5503
D6H (CRAWLERS) S/N: 4YF1-UP	
Hydraulic Oil Filter.....	H-5526
Hydraulic Oil Filter.....	H-55280
Hydraulic Oil Filter.....	H-5503
Hydraulic Oil Filter.....	HC-5511
Hydraulic Oil Filter.....	H-5510
D6H (CRAWLERS) S/N: 4YF5500-UP	
Hydraulic Oil Filter.....	H-5510
Hydraulic Oil Filter.....	H-5503
D6H (CRAWLERS) S/N: 5HF1-3999	
Hydraulic Oil Filter.....	H-5510
Hydraulic Oil Filter.....	H-5526
Hydraulic Oil Filter.....	HC-5511
Hydraulic Oil Filter.....	H-55280
Hydraulic Oil Filter.....	H-5503
D6H (CRAWLERS) S/N: 5HF1-4159	
Hydraulic Oil Filter.....	HC-55290
Hydraulic Oil Filter.....	HC-5511
Hydraulic Oil Filter.....	H-5510
Hydraulic Oil Filter.....	H-5503
D6H (CRAWLERS) S/N: 5HF4000-UP	
Hydraulic Oil Filter.....	H-55280
Hydraulic Oil Filter.....	H-5510
Hydraulic Oil Filter.....	HC-5511
Hydraulic Oil Filter.....	H-5526
Hydraulic Oil Filter.....	H-5503
D6H (CRAWLERS) S/N: 5HF4160-5513	
Hydraulic Oil Filter.....	HC-55290
Hydraulic Oil Filter.....	HC-5511
Hydraulic Oil Filter.....	H-5510
Hydraulic Oil Filter.....	H-5503
D6H (CRAWLERS) S/N: 5HF5514-UP	
Hydraulic Oil Filter.....	H-5510
Hydraulic Oil Filter.....	HC-5511
Hydraulic Oil Filter.....	H-5503
Hydraulic Oil Filter.....	HC-55290

MODEL/APPLICATION	SAKURA NO
CATERPILLAR	
D6H (CRAWLERS) S/N: 6CF1-3999	
Hydraulic Oil Filter.....	H-5526
Hydraulic Oil Filter.....	H-55280
Hydraulic Oil Filter.....	H-5510
Hydraulic Oil Filter.....	HC-5511
Hydraulic Oil Filter.....	H-5503
D6H (CRAWLERS) S/N: 6CF1-4159	
Hydraulic Oil Filter.....	H-5510
Hydraulic Oil Filter.....	HC-5511
Hydraulic Oil Filter.....	HC-55290
Hydraulic Oil Filter.....	H-5503
D6H (CRAWLERS) S/N: 6CF4000-UP	
Hydraulic Oil Filter.....	H-5503
Hydraulic Oil Filter.....	H-55280
Hydraulic Oil Filter.....	HC-5511
Hydraulic Oil Filter.....	H-5510
Hydraulic Oil Filter.....	H-5526
D6H (CRAWLERS) S/N: 6CF4160-5533	
Hydraulic Oil Filter.....	HC-55290
Hydraulic Oil Filter.....	H-5503
Hydraulic Oil Filter.....	H-5510
Hydraulic Oil Filter.....	HC-5511
D6H (CRAWLERS) S/N: 6CF5534-UP	
Hydraulic Oil Filter.....	HC-55290
Hydraulic Oil Filter.....	H-5503
Hydraulic Oil Filter.....	H-5510
Hydraulic Oil Filter.....	HC-5511
D6H (CRAWLERS) S/N: 6FC1-355	
Hydraulic Oil Filter.....	HC-55310
Hydraulic Oil Filter.....	H-5510
D6H (CRAWLERS) S/N: 6FC1-3999	
Hydraulic Oil Filter.....	H-5503
Hydraulic Oil Filter.....	HC-55310
Hydraulic Oil Filter.....	HC-5511
Hydraulic Oil Filter.....	H-5510
Hydraulic Oil Filter.....	H-5526
Hydraulic Oil Filter.....	H-55280
D6H (CRAWLERS) S/N: 6FC1-UP	
Hydraulic Oil Filter.....	H-5503
D6H (CRAWLERS) S/N: 6FC356-691	
Hydraulic Oil Filter.....	H-5510
Hydraulic Oil Filter.....	HC-55310
Hydraulic Oil Filter.....	H-55280
Hydraulic Oil Filter.....	H-5526



ENGINE APPLICATION

MODEL/APPLICATION	SAKURA NO	MODEL/APPLICATION	SAKURA NO	MODEL/APPLICATION	SAKURA NO
CATERPILLAR		CATERPILLAR		CATERPILLAR	
D6H (CRAWLERS) S/N: 6FC4000-UP Hydraulic Oil Filter..... HC-55310 Hydraulic Oil Filter..... H-5503 Hydraulic Oil Filter..... H-5526 Hydraulic Oil Filter..... H-5510 Hydraulic Oil Filter..... H-55280		D6H (CRAWLERS) S/N: 8FC4092-UP Hydraulic Oil Filter..... H-5503 Hydraulic Oil Filter..... H-5510 Hydraulic Oil Filter..... H-55280 Hydraulic Oil Filter..... H-5526 D6H (CRAWLERS) S/N: 8FC5500-UP Hydraulic Oil Filter..... H-5510 Hydraulic Oil Filter..... H-5503 D6H (CRAWLERS) S/N: 8KB1-440 Hydraulic Oil Filter..... HC-55310 D6H (CRAWLERS) S/N: 8KB1-UP Hydraulic Oil Filter..... HC-5511 Hydraulic Oil Filter..... HC-55310 Hydraulic Oil Filter..... H-5526 Hydraulic Oil Filter..... H-55280 Hydraulic Oil Filter..... H-5503 D6H (CRAWLERS) S/N: 8YC1-UP Hydraulic Oil Filter..... H-5503 Hydraulic Oil Filter..... H-55280 Hydraulic Oil Filter..... H-5526 Hydraulic Oil Filter..... HC-55310 Hydraulic Oil Filter..... HC-5511 D6H (CRAWLERS) S/N: TO-8KB441 Hydraulic Oil Filter..... HC-55310 Hydraulic Oil Filter..... H-5526 Hydraulic Oil Filter..... H-55280 D6H LGP (CRAWLERS) S/N: 1KD1-UP Hydraulic Oil Filter..... H-55280 Hydraulic Oil Filter..... HC-55310 Hydraulic Oil Filter..... HC-5511 Hydraulic Oil Filter..... H-5526 Hydraulic Oil Filter..... H-5503 D6H LGP (CRAWLERS) S/N: 2KD1-UP Hydraulic Oil Filter..... H-55280 Hydraulic Oil Filter..... H-5503 Hydraulic Oil Filter..... HC-5511 Hydraulic Oil Filter..... HC-55310 Hydraulic Oil Filter..... H-5526 D6H LGP (CRAWLERS) S/N: 2TG1-3999 Hydraulic Oil Filter..... H-5503 Hydraulic Oil Filter..... H-55280 Hydraulic Oil Filter..... HC-5511 Hydraulic Oil Filter..... HC-55310 Hydraulic Oil Filter..... H-5526		D6H LGP (CRAWLERS) S/N: 3ED1-UP Hydraulic Oil Filter..... H-5503 Hydraulic Oil Filter..... H-5526 Hydraulic Oil Filter..... HC-5511 Hydraulic Oil Filter..... HC-55310 Hydraulic Oil Filter..... H-55280 D6H LGP (CRAWLERS) S/N: 3YG1-3999 Hydraulic Oil Filter..... H-5526 Hydraulic Oil Filter..... HC-5511 Hydraulic Oil Filter..... H-5503 Hydraulic Oil Filter..... H-5510 Hydraulic Oil Filter..... H-55280 D6H LGP (CRAWLERS) S/N: 3ZF1-3999 Hydraulic Oil Filter..... H-5503 Hydraulic Oil Filter..... H-5526 Hydraulic Oil Filter..... H-5510 Hydraulic Oil Filter..... HC-5511 Hydraulic Oil Filter..... H-55280 D6H LGP (CRAWLERS) S/N: 4LG1-3999 Hydraulic Oil Filter..... HC-55310 Hydraulic Oil Filter..... H-5503 Hydraulic Oil Filter..... H-5526 Hydraulic Oil Filter..... HC-5511 Hydraulic Oil Filter..... H-55280 D6H LGP (CRAWLERS) S/N: 4RC1-3999 Hydraulic Oil Filter..... HC-55310 Hydraulic Oil Filter..... H-5510 Hydraulic Oil Filter..... H-5503 Hydraulic Oil Filter..... HC-5511 Hydraulic Oil Filter..... H-5526 Hydraulic Oil Filter..... H-55280 D6H LGP (CRAWLERS) S/N: 6FC1-3999 Hydraulic Oil Filter..... H-55280 Hydraulic Oil Filter..... H-5503 Hydraulic Oil Filter..... H-5526 Hydraulic Oil Filter..... HC-55310 Hydraulic Oil Filter..... HC-5511 Hydraulic Oil Filter..... H-5510 D6H LGP (CRAWLERS) S/N: 7PC1-UP Hydraulic Oil Filter..... H-55280 Hydraulic Oil Filter..... HC-55310 Hydraulic Oil Filter..... HC-5511 Hydraulic Oil Filter..... H-5510 D6H LGP (CRAWLERS) S/N: 8FC1-UP Hydraulic Oil Filter..... H-55280 Hydraulic Oil Filter..... HC-5511 Hydraulic Oil Filter..... HC-55310 Hydraulic Oil Filter..... H-5526 Hydraulic Oil Filter..... H-5503	



ENGINE APPLICATION

MODEL/APPLICATION	SAKURA NO	MODEL/APPLICATION	SAKURA NO	MODEL/APPLICATION	SAKURA NO
CATERPILLAR		CATERPILLAR		CATERPILLAR	
D6H LGP (CRAWLERS) S/N: 8FC1-UP		Hydraulic Oil Filter.....	H-5526	Hydraulic Oil Filter.....	H-55280
Hydraulic Oil Filter.....	HC-5511	Hydraulic Oil Filter.....	H-5503	Hydraulic Oil Filter.....	H-5526
Hydraulic Oil Filter.....	H-5526	Hydraulic Oil Filter.....	H-5510		
Hydraulic Oil Filter.....	HC-55310	Hydraulic Oil Filter.....	H-55280	D6H LS (CRAWLERS)	
				Hydraulic Oil Filter.....	HC-5511
D6H LGP (CRAWLERS) S/N: 8YC1-UP		D6H LGP SERIES II (CRAWLERS) S/N: 4GG5500-UP		Hydraulic Oil Filter.....	H-5510
Hydraulic Oil Filter.....	H-5503	Hydraulic Oil Filter.....	H-5526	Hydraulic Oil Filter.....	H-5503
Hydraulic Oil Filter.....	HC-55310	Hydraulic Oil Filter.....	H-5510		
Hydraulic Oil Filter.....	H-55280	Hydraulic Oil Filter.....	H-5503	D6H LS SERIES II (CRAWLERS) S/N: 2DK5500-UP	
Hydraulic Oil Filter.....	HC-5511	Hydraulic Oil Filter.....	HC-5511	Hydraulic Oil Filter.....	H-5526
Hydraulic Oil Filter.....	H-5526	Hydraulic Oil Filter.....	H-55280	Hydraulic Oil Filter.....	HC-5511
				Hydraulic Oil Filter.....	H-5503
D6H LGP SERIES II (CRAWLERS) S/N: 4YF5500-UP , TO-2001		D6H LGP SERIES II (CRAWLERS) S/N: 4LG4000-UP		Hydraulic Oil Filter.....	H-5510
Hydraulic Oil Filter.....	H-55280	Hydraulic Oil Filter.....	H-55280	Hydraulic Oil Filter.....	H-55280
Hydraulic Oil Filter.....	H-5510	Hydraulic Oil Filter.....	H-5503		
Hydraulic Oil Filter.....	H-5526	Hydraulic Oil Filter.....	H-5510	D6H SERIES II (CRAWLERS) S/N: 1F31-481	
Hydraulic Oil Filter.....	H-5503	Hydraulic Oil Filter.....	H-5526	Hydraulic Oil Filter.....	H-5503
Hydraulic Oil Filter.....	HC-5511				
		D6H LGP SERIES II (CRAWLERS) S/N: 4RC4000-UP		D6H SERIES II (CRAWLERS) S/N: 1F34000-5499	
D6H LGP SERIES II (CRAWLERS) S/N: 1KD4074-UP		Hydraulic Oil Filter.....	H-5526	Hydraulic Oil Filter.....	H-5510
Hydraulic Oil Filter.....	H-5510	Hydraulic Oil Filter.....	H-5510	Hydraulic Oil Filter.....	H-5503
Hydraulic Oil Filter.....	H-5526	Hydraulic Oil Filter.....	H-55280		
Hydraulic Oil Filter.....	H-5503	Hydraulic Oil Filter.....	H-5503	D6H SERIES II (CRAWLERS) S/N: 1F34000-UP	
Hydraulic Oil Filter.....	HC-5511			Hydraulic Oil Filter.....	H-5510
		D6H LGP SERIES II (CRAWLERS) S/N: 5HF4000-UP		Hydraulic Oil Filter.....	H-5503
D6H LGP SERIES II (CRAWLERS) S/N: 2KD4033-UP		Hydraulic Oil Filter.....	H-5510	Hydraulic Oil Filter.....	H-55280
Hydraulic Oil Filter.....	H-55280	Hydraulic Oil Filter.....	H-5503	Hydraulic Oil Filter.....	H-5526
Hydraulic Oil Filter.....	H-5526	Hydraulic Oil Filter.....	HC-5511		
Hydraulic Oil Filter.....	H-5503	Hydraulic Oil Filter.....	H-55280	D6H SERIES II (CRAWLERS) S/N: 1F3482-3999	
Hydraulic Oil Filter.....	H-5510	Hydraulic Oil Filter.....	H-5526	Hydraulic Oil Filter.....	H-5510
				Hydraulic Oil Filter.....	H-5503
D6H LGP SERIES II (CRAWLERS) S/N: 2TG4000-UP		D6H LGP SERIES II (CRAWLERS) S/N: 6CF4000-UP		D6H SERIES II (CRAWLERS) S/N: 1F3500-5540	
Hydraulic Oil Filter.....	H-5510	Hydraulic Oil Filter.....	H-5503	Hydraulic Oil Filter.....	H-5510
Hydraulic Oil Filter.....	H-5526	Hydraulic Oil Filter.....	HC-5511	Hydraulic Oil Filter.....	H-5503
Hydraulic Oil Filter.....	H-55280	Hydraulic Oil Filter.....	H-5510		
Hydraulic Oil Filter.....	H-5503	Hydraulic Oil Filter.....	H-5526	D6H SERIES II (CRAWLERS) S/N: 1F3541-5541	
		Hydraulic Oil Filter.....	H-55280	Hydraulic Oil Filter.....	H-5503
D6H LGP SERIES II (CRAWLERS) S/N: 2TL1-UP				Hydraulic Oil Filter.....	H-5510
Hydraulic Oil Filter.....	HC-5511	D6H LGP SERIES II (CRAWLERS) S/N: 6FC4000-UP			
Hydraulic Oil Filter.....	H-5503	Hydraulic Oil Filter.....	H-55280	D6H SERIES II (CRAWLERS) S/N: 1F3542-UP	
Hydraulic Oil Filter.....	H-5510	Hydraulic Oil Filter.....	H-5510	Hydraulic Oil Filter.....	H-5503
Hydraulic Oil Filter.....	H-55280	Hydraulic Oil Filter.....	H-5526	Hydraulic Oil Filter.....	H-5503
Hydraulic Oil Filter.....	H-5503	Hydraulic Oil Filter.....	H-5503		
		Hydraulic Oil Filter.....	HC-55310	D6H SERIES II (CRAWLERS) S/N: 1Y11-318	
D6H LGP SERIES II (CRAWLERS) S/N: 3YG4000-UP				Hydraulic Oil Filter.....	H-5503
Hydraulic Oil Filter.....	H-5510	D6H LGP SERIES II (CRAWLERS) S/N: 85K1-UP		Hydraulic Oil Filter.....	HC-55290
Hydraulic Oil Filter.....	HC-5511	Hydraulic Oil Filter.....	H-5503	Hydraulic Oil Filter.....	HC-5511
Hydraulic Oil Filter.....	H-5526	Hydraulic Oil Filter.....	H-5526	Hydraulic Oil Filter.....	H-5510
Hydraulic Oil Filter.....	H-55280	Hydraulic Oil Filter.....	H-5510		
Hydraulic Oil Filter.....	H-5503	Hydraulic Oil Filter.....	H-55280	D6H SERIES II (CRAWLERS) S/N: 1YL319-UP	
				Hydraulic Oil Filter.....	HC-5511
D6H LGP SERIES II (CRAWLERS) S/N: 3ZF4000-UP				Hydraulic Oil Filter.....	H-5503
Hydraulic Oil Filter.....	HC-5511				



ENGINE APPLICATION

MODEL/APPLICATION	SAKURA NO	MODEL/APPLICATION	SAKURA NO	MODEL/APPLICATION	SAKURA NO
CATERPILLAR		CATERPILLAR		CATERPILLAR	
D6H SERIES II (CRAWLERS) S/N: 1YL319-UP		Hydraulic Oil Filter.....	HC-55290	Hydraulic Oil Filter.....	HC-55290
Hydraulic Oil Filter.....	H-5510	Hydraulic Oil Filter.....	H-5526	Hydraulic Oil Filter.....	HC-5511
Hydraulic Oil Filter.....	HC-55290	Hydraulic Oil Filter.....	H-5510	Hydraulic Oil Filter.....	H-5526
D6H SERIES II (CRAWLERS) S/N: 2BL1-343		D6H SERIES II (CRAWLERS) S/N: 3YG4285-5499		D6H SERIES II (CRAWLERS) S/N: 3ZF5718-UP	
Hydraulic Oil Filter.....	H-5510	Hydraulic Oil Filter.....	H-5510	Hydraulic Oil Filter.....	H-5510
Hydraulic Oil Filter.....	H-5503	Hydraulic Oil Filter.....	HC-5511	Hydraulic Oil Filter.....	H-55280
D6H SERIES II (CRAWLERS) S/N: 2BL344-UP		Hydraulic Oil Filter.....	H-5503	Hydraulic Oil Filter.....	HC-5511
Hydraulic Oil Filter.....	H-5503	Hydraulic Oil Filter.....	HC-55290	Hydraulic Oil Filter.....	HC-55290
Hydraulic Oil Filter.....	H-5510	Hydraulic Oil Filter.....	H-55280	Hydraulic Oil Filter.....	H-5503
D6H SERIES II (CRAWLERS) S/N: 2DK1-UP		Hydraulic Oil Filter.....	H-5526	D6H SERIES II (CRAWLERS) S/N: 4LG1-934	
Hydraulic Oil Filter.....	H-55280	Hydraulic Oil Filter.....	H-5510	Hydraulic Oil Filter.....	H-5503
Hydraulic Oil Filter.....	H-5510	Hydraulic Oil Filter.....	H-5526	D6H SERIES II (CRAWLERS) S/N: 4LG4000-4410	
Hydraulic Oil Filter.....	H-5526	Hydraulic Oil Filter.....	H-5503	Hydraulic Oil Filter.....	H-5510
Hydraulic Oil Filter.....	H-5503	Hydraulic Oil Filter.....	HC-55290	Hydraulic Oil Filter.....	H-5503
Hydraulic Oil Filter.....	HC-5511	Hydraulic Oil Filter.....	HC-5511	D6H SERIES II (CRAWLERS) S/N: 4LG4411-5499	
D6H SERIES II (CRAWLERS) S/N: 2TG1-524		D6H SERIES II (CRAWLERS) S/N: 3YG5734-UP		Hydraulic Oil Filter.....	H-5510
Hydraulic Oil Filter.....	H-5503	Hydraulic Oil Filter.....	H-55280	Hydraulic Oil Filter.....	H-5503
D6H SERIES II (CRAWLERS) S/N: 2TG4000-4094		Hydraulic Oil Filter.....	HC-5511	D6H SERIES II (CRAWLERS) S/N: 4LG5500-5536	
Hydraulic Oil Filter.....	H-5503	Hydraulic Oil Filter.....	H-5526	Hydraulic Oil Filter.....	H-5503
Hydraulic Oil Filter.....	H-5510	Hydraulic Oil Filter.....	H-5510	Hydraulic Oil Filter.....	H-5510
D6H SERIES II (CRAWLERS) S/N: 2TG495-5499		Hydraulic Oil Filter.....	H-5503	D6H SERIES II (CRAWLERS) S/N: 4LG5537-5592	
Hydraulic Oil Filter.....	H-5510	Hydraulic Oil Filter.....	H-5526	Hydraulic Oil Filter.....	H-5503
Hydraulic Oil Filter.....	H-5503	Hydraulic Oil Filter.....	H-5503	Hydraulic Oil Filter.....	H-5510
D6H SERIES II (CRAWLERS) S/N: 2TG525-3999		D6H SERIES II (CRAWLERS) S/N: 3ZF1-1319		D6H SERIES II (CRAWLERS) S/N: 4LG5593-UP	
Hydraulic Oil Filter.....	H-5510	Hydraulic Oil Filter.....	H-55280	Hydraulic Oil Filter.....	H-5503
Hydraulic Oil Filter.....	H-5503	Hydraulic Oil Filter.....	H-5526	Hydraulic Oil Filter.....	H-5510
D6H SERIES II (CRAWLERS) S/N: 2TG5500-5587		D6H SERIES II (CRAWLERS) S/N: 3ZF4383-4441		D6H SERIES II (CRAWLERS) S/N: 4LG935-3999	
Hydraulic Oil Filter.....	H-5503	Hydraulic Oil Filter.....	HC-5511	Hydraulic Oil Filter.....	H-5503
Hydraulic Oil Filter.....	H-5510	Hydraulic Oil Filter.....	H-5526	Hydraulic Oil Filter.....	H-5510
D6H SERIES II (CRAWLERS) S/N: 2TG5588-5592		Hydraulic Oil Filter.....	H-55280	D6H SERIES II (CRAWLERS) S/N: 4RC1050-2444	
Hydraulic Oil Filter.....	H-5503	Hydraulic Oil Filter.....	H-5510	Hydraulic Oil Filter.....	H-5526
Hydraulic Oil Filter.....	H-5510	Hydraulic Oil Filter.....	HC-55290	Hydraulic Oil Filter.....	H-55310
D6H SERIES II (CRAWLERS) S/N: 2TG5593-UP		D6H SERIES II (CRAWLERS) S/N: 3ZF4442-5499		Hydraulic Oil Filter.....	H-55280
Hydraulic Oil Filter.....	H-5510	Hydraulic Oil Filter.....	HC-55290	Hydraulic Oil Filter.....	H-5510
Hydraulic Oil Filter.....	H-5503	Hydraulic Oil Filter.....	H-5510	D6H SERIES II (CRAWLERS) S/N: 4RC1-1049	
D6H SERIES II (CRAWLERS) S/N: 3YG1-4254		Hydraulic Oil Filter.....	HC-5511	Hydraulic Oil Filter.....	H-5510
Hydraulic Oil Filter.....	H-55280	Hydraulic Oil Filter.....	H-5526	Hydraulic Oil Filter.....	HC-55310
Hydraulic Oil Filter.....	H-5526	Hydraulic Oil Filter.....	H-5503	D6H SERIES II (CRAWLERS) S/N: 4RC2445-2550	
D6H SERIES II (CRAWLERS) S/N: 3YG4255-4284		Hydraulic Oil Filter.....	H-55280	Hydraulic Oil Filter.....	H-55280
Hydraulic Oil Filter.....	H-55280	Hydraulic Oil Filter.....	H-5510	Hydraulic Oil Filter.....	H-5526
		Hydraulic Oil Filter.....	H-5503	Hydraulic Oil Filter.....	HC-55310



ENGINE APPLICATION

MODEL/APPLICATION	SAKURA NO	MODEL/APPLICATION	SAKURA NO	MODEL/APPLICATION	SAKURA NO
CATERPILLAR		CATERPILLAR		CATERPILLAR	
D6H SERIES II (CRAWLERS) S/N: 4RC2445-2550		D6H SERIES II (CRAWLERS) S/N: 5KK1-UP		Hydraulic Oil Filter.....	H-5503
Hydraulic Oil Filter.....	H-5510	Hydraulic Oil Filter.....	H-55280	Hydraulic Oil Filter.....	H-5510
D6H SERIES II (CRAWLERS) S/N: 4RC2551-4050		Hydraulic Oil Filter.....	H-5526	D6H SERIES II (CRAWLERS) S/N: 6FC4077-4088	
Hydraulic Oil Filter.....	H-5526	Hydraulic Oil Filter.....	H-5510	Hydraulic Oil Filter.....	H-55280
Hydraulic Oil Filter.....	H-55280	Hydraulic Oil Filter.....	H-5503	Hydraulic Oil Filter.....	H-5510
Hydraulic Oil Filter.....	HC-55310	D6H SERIES II (CRAWLERS) S/N: 6CF1-4159		Hydraulic Oil Filter.....	H-5526
Hydraulic Oil Filter.....	H-5510	Hydraulic Oil Filter.....	H-5503	Hydraulic Oil Filter.....	HC-55310
D6H SERIES II (CRAWLERS) S/N: 4RC4051-4217		Hydraulic Oil Filter.....	HC-5511	D6H SERIES II (CRAWLERS) S/N: 6FC4089-5499	
Hydraulic Oil Filter.....	H-5510	Hydraulic Oil Filter.....	H-5510	Hydraulic Oil Filter.....	H-55280
Hydraulic Oil Filter.....	HC-55310	Hydraulic Oil Filter.....	H-5510	Hydraulic Oil Filter.....	H-5510
Hydraulic Oil Filter.....	H-5503	Hydraulic Oil Filter.....	HC-55290	Hydraulic Oil Filter.....	H-5503
Hydraulic Oil Filter.....	H-5526	D6H SERIES II (CRAWLERS) S/N: 6CF4160-5533		Hydraulic Oil Filter.....	H-5526
Hydraulic Oil Filter.....	H-55280	Hydraulic Oil Filter.....	HC-55290	Hydraulic Oil Filter.....	HC-55310
D6H SERIES II (CRAWLERS) S/N: 4RC4218-4302		Hydraulic Oil Filter.....	H-5510	D6H SERIES II (CRAWLERS) S/N: 6FC5500-UP	
Hydraulic Oil Filter.....	H-55280	Hydraulic Oil Filter.....	HC-5511	Hydraulic Oil Filter.....	HC-55310
Hydraulic Oil Filter.....	HC-55310	Hydraulic Oil Filter.....	H-5503	Hydraulic Oil Filter.....	H-5503
Hydraulic Oil Filter.....	H-5526	D6H SERIES II (CRAWLERS) S/N: 6CF5534-UP		Hydraulic Oil Filter.....	H-55280
Hydraulic Oil Filter.....	H-5510	Hydraulic Oil Filter.....	H-5503	Hydraulic Oil Filter.....	H-5526
D6H SERIES II (CRAWLERS) S/N: 4RC4303-5499		Hydraulic Oil Filter.....	H-5510	Hydraulic Oil Filter.....	H-5510
Hydraulic Oil Filter.....	H-5526	Hydraulic Oil Filter.....	HC-5511	D6H SERIES II (CRAWLERS) S/N: 6FC692-4033	
Hydraulic Oil Filter.....	HC-55310	Hydraulic Oil Filter.....	H-5503	Hydraulic Oil Filter.....	H-55280
Hydraulic Oil Filter.....	H-5510	Hydraulic Oil Filter.....	HC-5511	Hydraulic Oil Filter.....	H-5510
Hydraulic Oil Filter.....	H-5503	Hydraulic Oil Filter.....	HC-55290	Hydraulic Oil Filter.....	HC-55310
Hydraulic Oil Filter.....	H-55280	D6H SERIES II (CRAWLERS) S/N: 6CK1-347		Hydraulic Oil Filter.....	H-5526
D6H SERIES II (CRAWLERS) S/N: 4RC5500-UP		Hydraulic Oil Filter.....	HC-55290	Hydraulic Oil Filter.....	H-5510
Hydraulic Oil Filter.....	H-5503	Hydraulic Oil Filter.....	H-5510	Hydraulic Oil Filter.....	H-5510
Hydraulic Oil Filter.....	HC-55310	Hydraulic Oil Filter.....	HC-5511	D6H SERIES II (CRAWLERS) S/N: 7ZK1-UP	
Hydraulic Oil Filter.....	H-55280	Hydraulic Oil Filter.....	H-5503	Hydraulic Oil Filter.....	H-55280
Hydraulic Oil Filter.....	H-5526	Hydraulic Oil Filter.....	H-5526	Hydraulic Oil Filter.....	H-5510
Hydraulic Oil Filter.....	H-5510	Hydraulic Oil Filter.....	H-55280	Hydraulic Oil Filter.....	H-5526
D6H SERIES II (CRAWLERS) S/N: 5HF1-4159		D6H SERIES II (CRAWLERS) S/N: 6CK348-UP		Hydraulic Oil Filter.....	H-5503
Hydraulic Oil Filter.....	H-5503	Hydraulic Oil Filter.....	H-5510	D6H SERIES II (CRAWLERS) S/N: 8KK1-311	
Hydraulic Oil Filter.....	HC-55290	Hydraulic Oil Filter.....	HC-5511	Hydraulic Oil Filter.....	H-5510
Hydraulic Oil Filter.....	H-5510	Hydraulic Oil Filter.....	H-5503	Hydraulic Oil Filter.....	H-5503
Hydraulic Oil Filter.....	HC-5511	Hydraulic Oil Filter.....	H-55280	D6H SERIES II (CRAWLERS) S/N: 8KK312-313	
D6H SERIES II (CRAWLERS) S/N: 5HF4160-5513		D6H SERIES II (CRAWLERS) S/N: 6FC1-355		Hydraulic Oil Filter.....	H-5503
Hydraulic Oil Filter.....	H-5510	Hydraulic Oil Filter.....	H-5510	Hydraulic Oil Filter.....	H-5510
Hydraulic Oil Filter.....	HC-5511	Hydraulic Oil Filter.....	H-5526	D6H SERIES II (CRAWLERS) S/N: 8KK314-UP	
Hydraulic Oil Filter.....	H-5503	Hydraulic Oil Filter.....	HC-55290	Hydraulic Oil Filter.....	H-5503
Hydraulic Oil Filter.....	HC-55290	D6H SERIES II (CRAWLERS) S/N: 6FC356-691		Hydraulic Oil Filter.....	H-5510
D6H SERIES II (CRAWLERS) S/N: 5HF5514-UP		Hydraulic Oil Filter.....	H-5526	Hydraulic Oil Filter.....	H-5510
Hydraulic Oil Filter.....	HC-55290	Hydraulic Oil Filter.....	H-55280	D6H SERIES II (CRAWLERS) S/N: 8ZJ1-UP	
Hydraulic Oil Filter.....	H-5510	Hydraulic Oil Filter.....	H-5510	Hydraulic Oil Filter.....	H-5503
Hydraulic Oil Filter.....	HC-5511	Hydraulic Oil Filter.....	HC-55310	Hydraulic Oil Filter.....	H-5510
Hydraulic Oil Filter.....	H-5503	D6H SERIES II (CRAWLERS) S/N: 6FC4034-4076		Hydraulic Oil Filter.....	H-55280
D6H SERIES II (CRAWLERS) S/N: 5HF5514-UP		Hydraulic Oil Filter.....	H-55280	Hydraulic Oil Filter.....	H-55280
Hydraulic Oil Filter.....	HC-55290	Hydraulic Oil Filter.....	H-5526	Hydraulic Oil Filter.....	H-5526
Hydraulic Oil Filter.....	H-5510	Hydraulic Oil Filter.....	HC-55310	D6H SERIES II (CRAWLERS) S/N: 9KJ1-429	
Hydraulic Oil Filter.....	HC-5511	Hydraulic Oil Filter.....	H-5503		
Hydraulic Oil Filter.....	H-5503				



ENGINE APPLICATION

MODEL/APPLICATION	SAKURA NO	MODEL/APPLICATION	SAKURA NO	MODEL/APPLICATION	SAKURA NO
CATERPILLAR		CATERPILLAR		CATERPILLAR	
D6H SERIES II (CRAWLERS) S/N: 9KJ1-429		D6H XL (CRAWLERS) S/N: 9LK1-UP		Hydraulic Oil Filter.....	H-55280
Hydraulic Oil Filter.....	H-55280	Hydraulic Oil Filter.....	H-5510	Hydraulic Oil Filter.....	H-5526
Hydraulic Oil Filter.....	H-5503	Hydraulic Oil Filter.....	H-5503	Hydraulic Oil Filter.....	H-5510
Hydraulic Oil Filter.....	H-5510	Hydraulic Oil Filter.....	HC-5511	Hydraulic Oil Filter.....	H-5503
Hydraulic Oil Filter.....	HC-55290			D6H XR SERIES II (CRAWLERS) S/N: 6CK1-UP	
Hydraulic Oil Filter.....	HC-5511	D6H XL SERIES II (CRAWLERS) S/N: 8KK1-UP		Hydraulic Oil Filter.....	H-5503
Hydraulic Oil Filter.....	H-5526	Hydraulic Oil Filter.....	H-5510	Hydraulic Oil Filter.....	H-5510
		Hydraulic Oil Filter.....	H-5526	Hydraulic Oil Filter.....	HC-5511
D6H SERIES II (CRAWLERS) S/N: 9KJ430-UP		Hydraulic Oil Filter.....	H-5503	Hydraulic Oil Filter.....	H-55280
Hydraulic Oil Filter.....	HC-5511	Hydraulic Oil Filter.....	H-55280	Hydraulic Oil Filter.....	H-5526
Hydraulic Oil Filter.....	H-5503			D6K (CRAWLERS) CAT S/N: C6E1-UP , 2007-UP	
Hydraulic Oil Filter.....	H-5526	D6H XL SERIES II (CRAWLERS) S/N: 8ZJ1-UP		Hydraulic Oil Filter.....	HC-5504
Hydraulic Oil Filter.....	H-55280	Hydraulic Oil Filter.....	H-5510		
Hydraulic Oil Filter.....	H-5510	Hydraulic Oil Filter.....	H-5526	D6K (CRAWLERS) CAT S/N: FBH1-UP , 2007-UP	
Hydraulic Oil Filter.....	HC-55290	Hydraulic Oil Filter.....	H-55280	Hydraulic Oil Filter.....	HC-5504
		Hydraulic Oil Filter.....	H-5503		
D6H SERIES II (CRAWLERS) S/N: 9LK1-360		D6H XL SERIES II (CRAWLERS) S/N: 9LK1-UP		D6M (CRAWLERS) S/N: 5WF1-UP	
Hydraulic Oil Filter.....	H-5510	Hydraulic Oil Filter.....	H-55280	Hydraulic Oil Filter.....	H-5510
Hydraulic Oil Filter.....	H-5503	Hydraulic Oil Filter.....	H-5503		
Hydraulic Oil Filter.....	HC-55290	Hydraulic Oil Filter.....	HC-5511	D6M LGP (CRAWLERS) S/N: 2YS1-UP	
Hydraulic Oil Filter.....	HC-5511	Hydraulic Oil Filter.....	H-5526	Hydraulic Oil Filter.....	H-5510
		Hydraulic Oil Filter.....	H-5510	Hydraulic Oil Filter.....	HC-55220
D6H SERIES II (CRAWLERS) S/N: 9LK361-UP		D6H XR (CRAWLERS) S/N: 1YL1-UP		Hydraulic Oil Filter.....	HC-5507
Hydraulic Oil Filter.....	HC-55290	Hydraulic Oil Filter.....	H-5503		
Hydraulic Oil Filter.....	H-5510	D6H XR (CRAWLERS) S/N: 2BL1-UP		D6M LGP (CRAWLERS) S/N: 4GS1-UP	
Hydraulic Oil Filter.....	H-5503	Hydraulic Oil Filter.....	H-5503	Hydraulic Oil Filter.....	H-5510
Hydraulic Oil Filter.....	HC-5511			Hydraulic Oil Filter.....	HC-55220
		D6H XR (CRAWLERS) S/N: 5KK1-UP		Hydraulic Oil Filter.....	HC-5507
D6H SERIES II (CRAWLERS) S/N: 9RK1-UP		Hydraulic Oil Filter.....	H-5510	Hydraulic Oil Filter.....	HC-55220
Hydraulic Oil Filter.....	H-5503	D6H XR SERIES II (CRAWLERS) S/N: 1YL1-UP		Hydraulic Oil Filter.....	HC-5507
Hydraulic Oil Filter.....	H-5510	Hydraulic Oil Filter.....	H-5503		
Hydraulic Oil Filter.....	H-5526	Hydraulic Oil Filter.....	H-55280	D6M LGP (CRAWLERS) S/N: 4HS1-UP	
Hydraulic Oil Filter.....	H-55280	Hydraulic Oil Filter.....	HC-5511	Hydraulic Oil Filter.....	H-5510
		Hydraulic Oil Filter.....	H-5526	Hydraulic Oil Filter.....	HC-5507
D6H XL (CRAWLERS) S/N: 1YL,5KK,6CK,8KK,8ZJ,9KJ,9LK-UP		Hydraulic Oil Filter.....	H-5510	Hydraulic Oil Filter.....	HC-55220
Hydraulic Oil Filter.....	H-5510			Hydraulic Oil Filter.....	HC-55220
Hydraulic Oil Filter.....	H-5503	D6H XR (CRAWLERS) S/N: 6CK1-UP		Hydraulic Oil Filter.....	H-5510
Hydraulic Oil Filter.....	HC-5511	Hydraulic Oil Filter.....	H-5503		
		Hydraulic Oil Filter.....	H-5510	D6M LGP (CRAWLERS) S/N: 5NR1-UP	
D6H XL (CRAWLERS) S/N: 8KK1-UP		D6H XR SERIES II (CRAWLERS) S/N: 1YL1-UP		Hydraulic Oil Filter.....	HC-5507
Hydraulic Oil Filter.....	H-5510	Hydraulic Oil Filter.....	H-5503	Hydraulic Oil Filter.....	H-5526
Hydraulic Oil Filter.....	H-5503	Hydraulic Oil Filter.....	H-55280	Hydraulic Oil Filter.....	HC-55220
Hydraulic Oil Filter.....	HC-5511	Hydraulic Oil Filter.....	HC-5511	Hydraulic Oil Filter.....	H-5510
		Hydraulic Oil Filter.....	H-5526		
D6H XL (CRAWLERS) S/N: 8ZJ1-UP		Hydraulic Oil Filter.....	H-5510	D6M LGP (CRAWLERS) S/N: 9ZM1-UP	
Hydraulic Oil Filter.....	H-5503			Hydraulic Oil Filter.....	H-5510
Hydraulic Oil Filter.....	H-5510	D6H XR SERIES II (CRAWLERS) S/N: 2BL1-UP		Hydraulic Oil Filter.....	H-5526
		Hydraulic Oil Filter.....	H-5510	Hydraulic Oil Filter.....	HC-5507
D6H XL (CRAWLERS) S/N: 9KJ1-UP		Hydraulic Oil Filter.....	H-5526	Hydraulic Oil Filter.....	HC-55220
Hydraulic Oil Filter.....	H-55280	Hydraulic Oil Filter.....	H-55280		
Hydraulic Oil Filter.....	HC-5511	Hydraulic Oil Filter.....	H-5503	D6M XL (CRAWLERS) S/N: 2YS1-UP	
Hydraulic Oil Filter.....	H-5526	Hydraulic Oil Filter.....	H-5510	Hydraulic Oil Filter.....	H-5510
Hydraulic Oil Filter.....	H-5503	Hydraulic Oil Filter.....	H-5526	Hydraulic Oil Filter.....	HC-5507
Hydraulic Oil Filter.....	H-5510			Hydraulic Oil Filter.....	HC-55220
		D6H XR SERIES II (CRAWLERS) S/N: 5KK1-UP			
		Hydraulic Oil Filter.....	H-5510	D6M XL (CRAWLERS) S/N: 4GS1-UP	
		Hydraulic Oil Filter.....	H-5526	Hydraulic Oil Filter.....	H-5510
		Hydraulic Oil Filter.....	H-55280	Hydraulic Oil Filter.....	HC-5507
		Hydraulic Oil Filter.....	H-5503	Hydraulic Oil Filter.....	HC-55220



ENGINE APPLICATION

MODEL/APPLICATION	SAKURA NO	MODEL/APPLICATION	SAKURA NO	MODEL/APPLICATION	SAKURA NO
CATERPILLAR		CATERPILLAR		CATERPILLAR	
D6M XL (CRAWLERS) S/N: 4GS1-UP		Hydraulic Oil Filter.....	H-55280	D6N (CRAWLERS) S/N: CBJ260-399-UP	
Hydraulic Oil Filter.....	HC-55220	Hydraulic Oil Filter.....	H-5526	Hydraulic Oil Filter.....	H-5510
D6M XL (CRAWLERS) S/N: 4HS1-UP		Hydraulic Oil Filter.....	H-5510	Hydraulic Oil Filter.....	HC-55220
Hydraulic Oil Filter.....	H-5510	D6N (CRAWLERS) S/N: ALH347-UP		D6N (CRAWLERS) S/N: CBJ400-504-UP	
Hydraulic Oil Filter.....	HC-5507	Hydraulic Oil Filter.....	H-5510	Hydraulic Oil Filter.....	H-5510
Hydraulic Oil Filter.....	HC-55220	D6N (CRAWLERS) S/N: ALR1-219-UP		Hydraulic Oil Filter.....	HC-55220
D6M XL (CRAWLERS) S/N: 5NR1-UP		Hydraulic Oil Filter.....	H-5526	Hydraulic Oil Filter.....	HC-5507
Hydraulic Oil Filter.....	H-5510	Hydraulic Oil Filter.....	H-55280	D6N (CRAWLERS) S/N: CBJ505-UP	
Hydraulic Oil Filter.....	HC-5507	Hydraulic Oil Filter.....	HC-55220	Hydraulic Oil Filter.....	H-5510
Hydraulic Oil Filter.....	HC-55220	Hydraulic Oil Filter.....	HC-5507	Hydraulic Oil Filter.....	H-5510
D6N (CRAWLER TRACTORS) w/3126B Eng.		Hydraulic Oil Filter.....	H-5510	Hydraulic Oil Filter.....	HC-5507
Hydraulic Oil Filter.....	HC-55280	D6N (CRAWLERS) S/N: ALR220-251-UP		Hydraulic Oil Filter.....	HC-55220
D6N (CRAWLER TRACTORS) w/C9 Eng.		Hydraulic Oil Filter.....	HC-55220	D6N (CRAWLERS) S/N: CCK1-366-UP	
Hydraulic Oil Filter.....	HC-55280	Hydraulic Oil Filter.....	HC-5507	Hydraulic Oil Filter.....	H-5510
D6N (CRAWLERS) S/N: AKM1-675-UP		Hydraulic Oil Filter.....	H-5526	Hydraulic Oil Filter.....	H-55280
Hydraulic Oil Filter.....	H-55280	Hydraulic Oil Filter.....	H-5510	Hydraulic Oil Filter.....	HC-5504
Hydraulic Oil Filter.....	HC-5504	Hydraulic Oil Filter.....	H-5526	Hydraulic Oil Filter.....	H-5510
Hydraulic Oil Filter.....	H-5510	D6N (CRAWLERS) S/N: ALR324-UP		D6N (CRAWLERS) S/N: CCK367-691-UP	
Hydraulic Oil Filter.....	H-5526	Hydraulic Oil Filter.....	H-5510	Hydraulic Oil Filter.....	HC-5504
D6N (CRAWLERS) S/N: AKM1794-1821-UP		D6N (CRAWLERS) S/N: ALY1-705-UP		Hydraulic Oil Filter.....	H-5510
Hydraulic Oil Filter.....	HC-5504	Hydraulic Oil Filter.....	H-55280	Hydraulic Oil Filter.....	HC-5504
Hydraulic Oil Filter.....	H-5510	Hydraulic Oil Filter.....	H-5510	D6N (CRAWLERS) S/N: CCK702-708-UP	
D6N (CRAWLERS) S/N: AKM1822-UP		Hydraulic Oil Filter.....	H-5526	Hydraulic Oil Filter.....	H-5510
Hydraulic Oil Filter.....	H-5510	Hydraulic Oil Filter.....	HC-5504	D6N (CRAWLERS) S/N: DJA1-UP	
Hydraulic Oil Filter.....	HC-5504	D6N (CRAWLERS) S/N: ALY2066-2102-UP		Hydraulic Oil Filter.....	HC-5504
D6N (CRAWLERS) S/N: AKM676-1793-UP		Hydraulic Oil Filter.....	HC-5504	Hydraulic Oil Filter.....	H-5510
Hydraulic Oil Filter.....	HC-5504	Hydraulic Oil Filter.....	H-5510	D6N (CRAWLERS) S/N: DJY1-UP	
Hydraulic Oil Filter.....	H-5510	D6N (CRAWLERS) S/N: ALY706-2065-UP		Hydraulic Oil Filter.....	HC-5504
D6N (CRAWLERS) S/N: ALH1-197-UP		Hydraulic Oil Filter.....	HC-5504	Hydraulic Oil Filter.....	H-5510
Hydraulic Oil Filter.....	H-55280	D6N (CRAWLERS) S/N: CBJ1-259-UP		D6N (CRAWLERS) S/N: DJY1-UP	
Hydraulic Oil Filter.....	H-5510	Hydraulic Oil Filter.....	H-55280	Hydraulic Oil Filter.....	HC-5504
Hydraulic Oil Filter.....	HC-55220	Hydraulic Oil Filter.....	H-5526	Hydraulic Oil Filter.....	H-5510
Hydraulic Oil Filter.....	H-5526	Hydraulic Oil Filter.....	HC-55220	D6N (CRAWLER TRACTORS) w/3126B Eng.	
Hydraulic Oil Filter.....	H-55280	Hydraulic Oil Filter.....	HC-5507	Hydraulic Oil Filter.....	HC-55280
Hydraulic Oil Filter.....	HC-5507	Hydraulic Oil Filter.....	H-5510	D6N (CRAWLER TRACTORS) w/3126B Eng.	
D6N (CRAWLERS) S/N: ALH198-253-UP		D6N (CRAWLERS) S/N: ALY706-2065-UP		Hydraulic Oil Filter.....	HC-55280
Hydraulic Oil Filter.....	H-5510	Hydraulic Oil Filter.....	HC-5504	D6N (CRAWLER TRACTORS) w/3126B Eng.	
Hydraulic Oil Filter.....	HC-55220	Hydraulic Oil Filter.....	H-5510	Hydraulic Oil Filter.....	HC-55280
Hydraulic Oil Filter.....	H-5526	Hydraulic Oil Filter.....	H-5526	D6N (CRAWLER TRACTORS) w/3126B Eng.	
Hydraulic Oil Filter.....	H-55280	Hydraulic Oil Filter.....	HC-55220	Hydraulic Oil Filter.....	HC-55280
Hydraulic Oil Filter.....	HC-5507	Hydraulic Oil Filter.....	HC-5507	D6N (CRAWLER TRACTORS) w/3126B Eng.	
D6N (CRAWLERS) S/N: ALH254-346-UP		Hydraulic Oil Filter.....	H-5510	Hydraulic Oil Filter.....	HC-55280
Hydraulic Oil Filter.....	H-5510	D6N (CRAWLERS) S/N: ALY706-2065-UP		D6N (CRAWLER TRACTORS) w/3126B Eng.	
Hydraulic Oil Filter.....	HC-55220	Hydraulic Oil Filter.....	HC-5504	Hydraulic Oil Filter.....	HC-55280
Hydraulic Oil Filter.....	H-5526	Hydraulic Oil Filter.....	H-5510	D6N (CRAWLER TRACTORS) w/3126B Eng.	
Hydraulic Oil Filter.....	H-55280	Hydraulic Oil Filter.....	H-5510	Hydraulic Oil Filter.....	HC-55280
Hydraulic Oil Filter.....	HC-5507	Hydraulic Oil Filter.....	H-5510	D6N (CRAWLER TRACTORS) w/3126B Eng.	
D6N (CRAWLERS) S/N: ALH254-346-UP		Hydraulic Oil Filter.....	H-5510	Hydraulic Oil Filter.....	HC-55280
Hydraulic Oil Filter.....	H-5510	Hydraulic Oil Filter.....	H-5510	Hydraulic Oil Filter.....	HC-55280



ENGINE APPLICATION

MODEL/APPLICATION	SAKURA NO
CATERPILLAR	
D6N XL (CRAWLER TRACTORS) w/3126B Eng.	
D6R (CRAWLERS) CAT C9 (S/N: 1RW1-UP)	
Hydraulic Oil Filter.....	H-5526
Hydraulic Oil Filter.....	H-5510
Hydraulic Oil Filter.....	HC-5511
D6R (CRAWLERS) CAT C9 (S/N: 2HM1-UP)	
Hydraulic Oil Filter.....	HC-5511
Hydraulic Oil Filter.....	H-5510
Hydraulic Oil Filter.....	H-5526
D6R (CRAWLERS) CAT C9 (S/N: 2YN1-UP)	
Hydraulic Oil Filter.....	H-5510
Hydraulic Oil Filter.....	H-5526
Hydraulic Oil Filter.....	HC-5511
D6R (CRAWLERS) CAT C9 (S/N: 3ZN1-UP)	
Hydraulic Oil Filter.....	HC-5511
Hydraulic Oil Filter.....	H-5526
Hydraulic Oil Filter.....	H-5510
D6R (CRAWLERS) CAT C9 (S/N: 4FM1-UP)	
Hydraulic Oil Filter.....	H-5510
Hydraulic Oil Filter.....	H-5526
Hydraulic Oil Filter.....	HC-5511
D6R (CRAWLERS) CAT C9 (S/N: 4JRI-UP)	
Hydraulic Oil Filter.....	H-5510
Hydraulic Oil Filter.....	HC-5511
Hydraulic Oil Filter.....	H-5526
D6R (CRAWLERS) CAT C9 (S/N: 4TR1-UP)	
Hydraulic Oil Filter.....	HC-5511
Hydraulic Oil Filter.....	H-5526
Hydraulic Oil Filter.....	H-5510
D6R (CRAWLERS) CAT C9 (S/N: 4WF1-UP)	
Hydraulic Oil Filter.....	H-5526
Hydraulic Oil Filter.....	H-5510
Hydraulic Oil Filter.....	HC-5511
D6R (CRAWLERS) CAT C9 (S/N: 5LN1-UP)	
Hydraulic Oil Filter.....	HC-5511
Hydraulic Oil Filter.....	H-5526
Hydraulic Oil Filter.....	H-5510

MODEL/APPLICATION	SAKURA NO
CATERPILLAR	
D6R (CRAWLERS) CAT C9 (S/N: 5PR1-UP)	
Hydraulic Oil Filter.....	H-5526
Hydraulic Oil Filter.....	HC-5511
Hydraulic Oil Filter.....	H-5510
D6R (CRAWLERS) CAT C9 (S/N: 6FR1-UP)	
Hydraulic Oil Filter.....	H-5526
Hydraulic Oil Filter.....	H-5510
Hydraulic Oil Filter.....	HC-5511
D6R (CRAWLERS) CAT C9 (S/N: 6MR1-UP)	
Hydraulic Oil Filter.....	H-5510
Hydraulic Oil Filter.....	H-5526
Hydraulic Oil Filter.....	HC-5511
D6R (CRAWLERS) CAT C9 (S/N: 7DR1-UP)	
Hydraulic Oil Filter.....	HC-5511
Hydraulic Oil Filter.....	H-5526
Hydraulic Oil Filter.....	H-5510
D6R (CRAWLERS) CAT C9 (S/N: 7GR1-UP)	
Hydraulic Oil Filter.....	H-5526
Hydraulic Oil Filter.....	HC-5511
Hydraulic Oil Filter.....	H-5510
D6R (CRAWLERS) CAT C9 (S/N: 7KN1-UP)	
Hydraulic Oil Filter.....	H-5510
Hydraulic Oil Filter.....	H-5526
Hydraulic Oil Filter.....	HC-5511
D6R (CRAWLERS) CAT C9 (S/N: 8LN1-UP)	
Hydraulic Oil Filter.....	H-5526
Hydraulic Oil Filter.....	HC-5511
Hydraulic Oil Filter.....	H-5510
D6R (CRAWLERS) CAT C9 (S/N: 9BM1-UP)	
Hydraulic Oil Filter.....	H-5526
Hydraulic Oil Filter.....	HC-5511
Hydraulic Oil Filter.....	H-5510
D6R (CRAWLERS) CAT C9 (S/N: 9MN1-UP)	
Hydraulic Oil Filter.....	H-5510
Hydraulic Oil Filter.....	H-5526
Hydraulic Oil Filter.....	HC-5511
D6R (CRAWLERS) CAT C9 (S/N: 9PN1-UP)	
Hydraulic Oil Filter.....	H-5526
Hydraulic Oil Filter.....	HC-5511
Hydraulic Oil Filter.....	H-5510
D6R (CRAWLERS) CAT C9 (S/N: 9ZS1-UP)	
Hydraulic Oil Filter.....	H-5510

MODEL/APPLICATION	SAKURA NO
CATERPILLAR	
Hydraulic Oil Filter.....	HC-5511
Hydraulic Oil Filter.....	H-5526
D6R (CRAWLERS) S/N: 1RW1-UP	
Hydraulic Oil Filter.....	HC-55290
Hydraulic Oil Filter.....	H-55280
Hydraulic Oil Filter.....	HC-5511
Hydraulic Oil Filter.....	H-5510
Hydraulic Oil Filter.....	H-5526
D6R (CRAWLERS) S/N: 2HM1-UP	
Hydraulic Oil Filter.....	H-5510
Hydraulic Oil Filter.....	HC-5511
Hydraulic Oil Filter.....	H-55280
Hydraulic Oil Filter.....	H-5526
Hydraulic Oil Filter.....	HC-55290
D6R (CRAWLERS) S/N: 2YN1-UP	
Hydraulic Oil Filter.....	HC-5511
Hydraulic Oil Filter.....	H-5526
Hydraulic Oil Filter.....	HC-55290
Hydraulic Oil Filter.....	H-5510
Hydraulic Oil Filter.....	H-55280
D6R (CRAWLERS) S/N: 3ZN1-UP	
Hydraulic Oil Filter.....	H-55280
Hydraulic Oil Filter.....	HC-55290
Hydraulic Oil Filter.....	H-5526
Hydraulic Oil Filter.....	HC-5511
Hydraulic Oil Filter.....	H-5510
D6R (CRAWLERS) S/N: 4FM1-UP	
Hydraulic Oil Filter.....	H-5510
Hydraulic Oil Filter.....	HC-5511
Hydraulic Oil Filter.....	HC-55290
Hydraulic Oil Filter.....	H-55280
Hydraulic Oil Filter.....	H-5526
D6R (CRAWLERS) S/N: 4HN1-UP	
Hydraulic Oil Filter.....	HC-55290
Hydraulic Oil Filter.....	H-5510
Hydraulic Oil Filter.....	H-55280
Hydraulic Oil Filter.....	H-5526
Hydraulic Oil Filter.....	HC-5511
D6R (CRAWLERS) S/N: 4JRI-UP	
Hydraulic Oil Filter.....	HC-55290
Hydraulic Oil Filter.....	H-5510
Hydraulic Oil Filter.....	H-55280
Hydraulic Oil Filter.....	H-5526
Hydraulic Oil Filter.....	HC-5511
D6R (CRAWLERS) S/N: 4MN1-UP	
Hydraulic Oil Filter.....	H-5526
Hydraulic Oil Filter.....	H-5510



ENGINE APPLICATION

MODEL/APPLICATION	SAKURA NO	MODEL/APPLICATION	SAKURA NO	MODEL/APPLICATION	SAKURA NO
CATERPILLAR		CATERPILLAR		CATERPILLAR	
D6R (CRAWLERS) S/N: 4MN1-UP		D6R (CRAWLERS) S/N: 8XN1-UP		Hydraulic Oil Filter.....	HC-5511
Hydraulic Oil Filter.....	H-55280	Hydraulic Oil Filter.....	H-5526	D6R II (CRAWLERS) S/N: ADE1-UP	
Hydraulic Oil Filter.....	HC-55290	Hydraulic Oil Filter.....	H-5510	Hydraulic Oil Filter.....	HC-55290
Hydraulic Oil Filter.....	HC-5511	Hydraulic Oil Filter.....	HC-5511	Hydraulic Oil Filter.....	H-55280
D6R (CRAWLERS) S/N: 5LN1-UP		Hydraulic Oil Filter.....	HC-55290	Hydraulic Oil Filter.....	H-5510
Hydraulic Oil Filter.....	H-55280	Hydraulic Oil Filter.....	H-55280	Hydraulic Oil Filter.....	HC-5511
Hydraulic Oil Filter.....	H-5510	D6R (CRAWLERS) S/N: 9BM1-UP		Hydraulic Oil Filter.....	H-5526
Hydraulic Oil Filter.....	HC-55290	Hydraulic Oil Filter.....	HC-55290	D6R II (CRAWLERS) S/N: AEM1-UP	
Hydraulic Oil Filter.....	HC-5511	Hydraulic Oil Filter.....	H-5526	Hydraulic Oil Filter.....	H-5510
Hydraulic Oil Filter.....	H-5526	Hydraulic Oil Filter.....	HC-5511	Hydraulic Oil Filter.....	HC-5511
D6R (CRAWLERS) S/N: 6JN1-UP		Hydraulic Oil Filter.....	H-55280	Hydraulic Oil Filter.....	H-55280
Hydraulic Oil Filter.....	H-55280	Hydraulic Oil Filter.....	H-5510	Hydraulic Oil Filter.....	H-5526
Hydraulic Oil Filter.....	HC-5511	D6R (CRAWLERS) S/N: 9MN1-UP		Hydraulic Oil Filter.....	HC-55290
Hydraulic Oil Filter.....	HC-55290	Hydraulic Oil Filter.....	HC-55290	D6R II (CRAWLERS) S/N: AEP1-UP	
Hydraulic Oil Filter.....	H-5526	Hydraulic Oil Filter.....	H-5526	Hydraulic Oil Filter.....	H-5526
Hydraulic Oil Filter.....	H-5510	Hydraulic Oil Filter.....	H-55280	Hydraulic Oil Filter.....	HC-5511
D6R (CRAWLERS) S/N: 6MR1-UP		Hydraulic Oil Filter.....	HC-55290	Hydraulic Oil Filter.....	H-5510
Hydraulic Oil Filter.....	HC-55290	Hydraulic Oil Filter.....	HC-5511	Hydraulic Oil Filter.....	HC-55290
Hydraulic Oil Filter.....	H-55280	D6R (CRAWLERS) S/N: 9PN1-UP		Hydraulic Oil Filter.....	H-55280
Hydraulic Oil Filter.....	H-5510	Hydraulic Oil Filter.....	HC-5511	D6R II (CRAWLERS) S/N: AFM1-UP	
Hydraulic Oil Filter.....	HC-5511	Hydraulic Oil Filter.....	HC-55290	Hydraulic Oil Filter.....	HC-55290
Hydraulic Oil Filter.....	H-5526	Hydraulic Oil Filter.....	H-5510	Hydraulic Oil Filter.....	H-5510
D6R (CRAWLERS) S/N: 7GR1-UP		Hydraulic Oil Filter.....	H-55280	Hydraulic Oil Filter.....	HC-5511
Hydraulic Oil Filter.....	H-5526	Hydraulic Oil Filter.....	H-5526	Hydraulic Oil Filter.....	H-55280
Hydraulic Oil Filter.....	HC-55290	D6R (CRAWLERS) S/N: 9ZS1-UP		Hydraulic Oil Filter.....	H-5526
Hydraulic Oil Filter.....	H-55280	Hydraulic Oil Filter.....	H-55280	D6R II (CRAWLERS) S/N: AGM1-UP	
Hydraulic Oil Filter.....	H-5510	Hydraulic Oil Filter.....	HC-55290	Hydraulic Oil Filter.....	H-5526
Hydraulic Oil Filter.....	HC-5511	Hydraulic Oil Filter.....	H-5526	Hydraulic Oil Filter.....	H-5510
D6R (CRAWLERS) S/N: 7KN1-UP		Hydraulic Oil Filter.....	H-5510	Hydraulic Oil Filter.....	H-55280
Hydraulic Oil Filter.....	HC-5511	Hydraulic Oil Filter.....	HC-5511	Hydraulic Oil Filter.....	HC-5511
Hydraulic Oil Filter.....	H-5526	D6R (CRAWLERS) S/N: 9MP1-UP		Hydraulic Oil Filter.....	HC-55290
Hydraulic Oil Filter.....	HC-55290	Hydraulic Oil Filter.....	H-5526	D6R II (CRAWLERS) S/N: BLE1-UP	
Hydraulic Oil Filter.....	H-5510	Hydraulic Oil Filter.....	H-55280	Hydraulic Oil Filter.....	H-55280
Hydraulic Oil Filter.....	H-55280	Hydraulic Oil Filter.....	H-5510	Hydraulic Oil Filter.....	HC-55290
D6R (CRAWLERS) S/N: 8LN1-UP		Hydraulic Oil Filter.....	HC-55290	Hydraulic Oil Filter.....	HC-5511
Hydraulic Oil Filter.....	H-5526	Hydraulic Oil Filter.....	HC-5511	Hydraulic Oil Filter.....	H-5526
Hydraulic Oil Filter.....	H-5510	D6R II (CRAWLERS) S/N: AAX1-UP		D6R II (CRAWLERS) S/N: BLT1-UP	
Hydraulic Oil Filter.....	H-55280	Hydraulic Oil Filter.....	H-55280	Hydraulic Oil Filter.....	H-55280
Hydraulic Oil Filter.....	HC-55290	Hydraulic Oil Filter.....	H-5510	Hydraulic Oil Filter.....	HC-5511
Hydraulic Oil Filter.....	HC-5511	Hydraulic Oil Filter.....	HC-5511	Hydraulic Oil Filter.....	H-5526
D6R (CRAWLERS) S/N: 8TM1-UP		Hydraulic Oil Filter.....	H-5526	Hydraulic Oil Filter.....	H-55280
Hydraulic Oil Filter.....	HC-55290	Hydraulic Oil Filter.....	HC-55290	D6R II (CRAWLERS) S/N: BMJ1-UP	
Hydraulic Oil Filter.....	H-5510	Hydraulic Oil Filter.....	HC-5511	Hydraulic Oil Filter.....	HC-55290
Hydraulic Oil Filter.....	H-55280	Hydraulic Oil Filter.....	H-5510	Hydraulic Oil Filter.....	HC-5511
Hydraulic Oil Filter.....	HC-5511	Hydraulic Oil Filter.....	H-55280	Hydraulic Oil Filter.....	H-55280
Hydraulic Oil Filter.....	H-5526	Hydraulic Oil Filter.....	HC-55290	Hydraulic Oil Filter.....	H-5526
D6R II (CRAWLERS) S/N: ACJ1-UP		Hydraulic Oil Filter.....	H-5526		
Hydraulic Oil Filter.....	H-5510				
Hydraulic Oil Filter.....	H-55280				
Hydraulic Oil Filter.....	HC-55290				
Hydraulic Oil Filter.....	H-5526				



ENGINE APPLICATION

MODEL/APPLICATION	SAKURA NO	MODEL/APPLICATION	SAKURA NO	MODEL/APPLICATION	SAKURA NO
CATERPILLAR		CATERPILLAR		CATERPILLAR	
D6R II (CRAWLERS) S/N: BMY1-UP		Hydraulic Oil Filter.....	H-5510	D7 (CRAWLERS) S/N: 45W1-UP	
Hydraulic Oil Filter.....	H-55280	D6R III (CRAWLERS) S/N: GMT1-UP		Hydraulic Oil Filter.....	H-5503
Hydraulic Oil Filter.....	H-5526	Hydraulic Oil Filter.....	H-5510	Hydraulic Oil Filter.....	H-5506
Hydraulic Oil Filter.....	HC-5511	D6R III (CRAWLERS) S/N: HCD1-UP		D7 (CRAWLERS) S/N: 65V1-UP	
Hydraulic Oil Filter.....	HC-55290	Hydraulic Oil Filter.....	H-5510	Hydraulic Oil Filter.....	H-5506
D6R II (CRAWLERS) S/N: BNC1-UP		D6R III (CRAWLERS) S/N: HDC1-UP		Hydraulic Oil Filter.....	H-5503
Hydraulic Oil Filter.....	HC-55290	Hydraulic Oil Filter.....	H-5510	D7 (CRAWLERS) S/N: 93N1-961	
Hydraulic Oil Filter.....	H-5526	D6R III (CRAWLERS) S/N: HKE1-UP		Hydraulic Oil Filter.....	H-5503
Hydraulic Oil Filter.....	HC-5511	Hydraulic Oil Filter.....	H-5510	D7 (CRAWLERS) S/N: 94N1-3356	
Hydraulic Oil Filter.....	H-55280	D6R III (CRAWLERS) S/N: JDL1-UP		Hydraulic Oil Filter.....	H-5503
D6R II (CRAWLERS) S/N: BPM1-UP		Hydraulic Oil Filter.....	H-5510	D7E (CRAWLERS) S/N: 47A1-3395	
Hydraulic Oil Filter.....	HC-55290	D6R III (CRAWLERS) S/N: LFM1-UP		Hydraulic Oil Filter.....	H-5504
Hydraulic Oil Filter.....	HC-5511	Hydraulic Oil Filter.....	H-5510	D7E (CRAWLERS) S/N: 47A3396-3677	
Hydraulic Oil Filter.....	H-5526	D6R III (CRAWLERS) S/N: MRT1-UP		Hydraulic Oil Filter.....	H-5503
Hydraulic Oil Filter.....	H-55280	Hydraulic Oil Filter.....	H-5510	D7E (CRAWLERS) S/N: 47A3678-UP	
D6R II (CRAWLERS) S/N: BRJ1-UP		D6R III (CRAWLERS) S/N: MTJ1-UP		Hydraulic Oil Filter.....	H-5503
Hydraulic Oil Filter.....	H-5526	Hydraulic Oil Filter.....	H-5510	D7E (CRAWLERS) S/N: 48A1-6392	
Hydraulic Oil Filter.....	HC-55290	D6R III (CRAWLERS) S/N: RFC1-UP		Hydraulic Oil Filter.....	H-5504
Hydraulic Oil Filter.....	H-55280	Hydraulic Oil Filter.....	H-5510	D7F (CRAWLERS) S/N: 93N1-1174	
Hydraulic Oil Filter.....	HC-5511	D6R III (CRAWLERS) S/N: TBC1-UP		Hydraulic Oil Filter.....	H-5503
D6R II (CRAWLERS) S/N: DAE1-UP		Hydraulic Oil Filter.....	H-5510	D7F (CRAWLERS) S/N: 93N1175-UP	
Hydraulic Oil Filter.....	HC-55290	D6R III (CRAWLERS) S/N: WCB1-UP		Hydraulic Oil Filter.....	H-5503
Hydraulic Oil Filter.....	HC-5511	Hydraulic Oil Filter.....	H-5510	D7F (CRAWLERS) S/N: 94N1-5191	
Hydraulic Oil Filter.....	H-5526	D6R III (CRAWLERS) S/N: WRG1-UP		Hydraulic Oil Filter.....	H-5503
Hydraulic Oil Filter.....	H-55280	Hydraulic Oil Filter.....	H-5510	D7F (CRAWLERS) S/N: 94N5192-UP	
Hydraulic Oil Filter.....	H-55280	D6R XL (TRACTORS) CAT 3306		Hydraulic Oil Filter.....	H-5503
D6R II (CRAWLERS) S/N: FDT1-UP		Hydraulic Oil Filter.....	HC-5511	D7G (CRAWLERS) CAT 3306T (S/N: 35N1-UP)	
Hydraulic Oil Filter.....	H-5526	Hydraulic Oil Filter.....	H-5510	Hydraulic Oil Filter.....	H-5503
Hydraulic Oil Filter.....	HC-5511	D6R XW (CRAWLERS) CAT C9 (S/N: DMP1-UP)		Hydraulic Oil Filter.....	H-55280
Hydraulic Oil Filter.....	H-55280	Hydraulic Oil Filter.....	HC-5511	Hydraulic Oil Filter.....	H-5526
Hydraulic Oil Filter.....	HC-55290	Hydraulic Oil Filter.....	H-5510	Hydraulic Oil Filter.....	H-5506
D6R III (CRAWLERS) S/N: DLM1-UP		D6R III (CRAWLERS) S/N: DMK1-UP		D7G (CRAWLERS) CAT 3306T (S/N: 3GF1-UP)	
Hydraulic Oil Filter.....	H-5510	Hydraulic Oil Filter.....	H-5510	Hydraulic Oil Filter.....	H-55280
D6R III (CRAWLERS) S/N: DPS1-UP		Hydraulic Oil Filter.....	H-5526	Hydraulic Oil Filter.....	H-5503
Hydraulic Oil Filter.....	H-5510	Hydraulic Oil Filter.....	H-5510	Hydraulic Oil Filter.....	H-5506
D6R III (CRAWLERS) S/N: GJB1-UP		D6R2 (DOZERS) CAT C9		Hydraulic Oil Filter.....	H-5526
Hydraulic Oil Filter.....	H-5510	Hydraulic Oil Filter.....	HC-5511	D7G (CRAWLERS) CAT 3306T (S/N: 3ZD1-UP)	
D6R III (CRAWLERS) S/N: GJB1-UP		Hydraulic Oil Filter.....	H-5526	Hydraulic Oil Filter.....	H-5503
Hydraulic Oil Filter.....	H-5510			Hydraulic Oil Filter.....	H-5506
				Hydraulic Oil Filter.....	H-5526



ENGINE APPLICATION

MODEL/APPLICATION	SAKURA NO	MODEL/APPLICATION	SAKURA NO	MODEL/APPLICATION	SAKURA NO
CATERPILLAR		CATERPILLAR		CATERPILLAR	
D7G (CRAWLERS) CAT 3306T (S/N: 3ZD1-UP)		Hydraulic Oil Filter.....	H-5526	D7H (CRAWLERS) S/N: 4FG5632-UP	
Hydraulic Oil Filter.....	H-5506	Hydraulic Oil Filter.....	H-5503	Hydraulic Oil Filter.....	H-5526
Hydraulic Oil Filter.....	H-55280	Hydraulic Oil Filter.....	H-55280	Hydraulic Oil Filter.....	H-55280
Hydraulic Oil Filter.....	H-5526	Hydraulic Oil Filter.....	HC-5511	Hydraulic Oil Filter.....	H-5503
Hydraulic Oil Filter.....	H-5503				
D7G (CRAWLERS) CAT 3306T (S/N: 44W1-440)		D7H (CRAWLERS) S/N: 2SB1-UP		D7H (CRAWLERS) S/N: 5BF1-3999	
Hydraulic Oil Filter.....	H-5503	Hydraulic Oil Filter.....	H-55280	Hydraulic Oil Filter.....	HC-5511
		Hydraulic Oil Filter.....	H-5510	Hydraulic Oil Filter.....	H-5503
		Hydraulic Oil Filter.....	H-5526	Hydraulic Oil Filter.....	H-55280
		Hydraulic Oil Filter.....	H-5503	Hydraulic Oil Filter.....	H-5526
D7G (CRAWLERS) CAT 3306T (S/N: 44W441-UP)		D7H (CRAWLERS) S/N: 3XG1-UP		D7H (CRAWLERS) S/N: 5BF1-613	
Hydraulic Oil Filter.....	H-5506	Hydraulic Oil Filter.....	H-5526	Hydraulic Oil Filter.....	H-5503
Hydraulic Oil Filter.....	H-5503	Hydraulic Oil Filter.....	H-5503	Hydraulic Oil Filter.....	H-5526
Hydraulic Oil Filter.....	H-55280	Hydraulic Oil Filter.....	HC-5511	Hydraulic Oil Filter.....	H-55280
Hydraulic Oil Filter.....	H-5526	Hydraulic Oil Filter.....	H-55280	Hydraulic Oil Filter.....	H-55280
D7G (CRAWLERS) CAT 3306T (S/N: 45W407-UP)		D7H (CRAWLERS) S/N: 4AB1-UP		D7H (CRAWLERS) S/N: 5BF4000-UP	
Hydraulic Oil Filter.....	H-5506	Hydraulic Oil Filter.....	H-5503	Hydraulic Oil Filter.....	H-5503
		Hydraulic Oil Filter.....	H-5526		
D7G (CRAWLERS) CAT 3306T (S/N: 65V1-UP)		Hydraulic Oil Filter.....	H-55280	D7H (CRAWLERS) S/N: 5BF5500-6032	
Hydraulic Oil Filter.....	H-5506	Hydraulic Oil Filter.....	H-5510	Hydraulic Oil Filter.....	H-5503
Hydraulic Oil Filter.....	H-5503	Hydraulic Oil Filter.....	H-5503	Hydraulic Oil Filter.....	H-5526
		Hydraulic Oil Filter.....	H-55280	Hydraulic Oil Filter.....	H-55280
D7G (CRAWLERS) CAT 3306T (S/N: 72W1-UP)		Hydraulic Oil Filter.....	H-5510	Hydraulic Oil Filter.....	H-55280
Hydraulic Oil Filter.....	H-5503	Hydraulic Oil Filter.....	H-5503		
		Hydraulic Oil Filter.....	H-5526	D7H (CRAWLERS) S/N: 5BF6033-UP	
D7G (CRAWLERS) CAT 3306T (S/N: 91V1-UP)		D7H (CRAWLERS) S/N: 4FG1-328		Hydraulic Oil Filter.....	H-5526
Hydraulic Oil Filter.....	H-5503	Hydraulic Oil Filter.....	H-55280	Hydraulic Oil Filter.....	H-55280
		Hydraulic Oil Filter.....	H-5503	Hydraulic Oil Filter.....	H-5503
D7G (CRAWLERS) CAT 3306T (S/N: 92V1-UP)		Hydraulic Oil Filter.....	H-5526	D7H (CRAWLERS) S/N: 5BF614-5499	
Hydraulic Oil Filter.....	H-5503	D7H (CRAWLERS) S/N: 4FG1-UP		Hydraulic Oil Filter.....	H-55280
		Hydraulic Oil Filter.....	H-55280	Hydraulic Oil Filter.....	H-5526
D7G (CRAWLERS) CAT 3306T (S/N: 93N962-UP)		Hydraulic Oil Filter.....	HC-5511	Hydraulic Oil Filter.....	H-5503
Hydraulic Oil Filter.....	H-5503	Hydraulic Oil Filter.....	H-5526		
		Hydraulic Oil Filter.....	H-5503	D7H (CRAWLERS) S/N: 5WB1-UP	
D7G (CRAWLERS) CAT 3306T (S/N: 94N3357-UP)		D7H (CRAWLERS) S/N: 4FG329-5499		Hydraulic Oil Filter.....	H-55280
Hydraulic Oil Filter.....	H-5503	Hydraulic Oil Filter.....	H-5503	Hydraulic Oil Filter.....	H-5503
		Hydraulic Oil Filter.....	H-55280	Hydraulic Oil Filter.....	H-5510
D7G (CRAWLERS) CAT 3606		Hydraulic Oil Filter.....	H-5526	Hydraulic Oil Filter.....	H-5526
Hydraulic Oil Filter.....	H-5503	Hydraulic Oil Filter.....	H-5526		
		D7H (CRAWLERS) S/N: 4FG4000-UP		D7H (CRAWLERS) S/N: 5WB5500-UP	
D7G LGP (CRAWLERS) S/N: 44W1-547		Hydraulic Oil Filter.....	HC-5511	Hydraulic Oil Filter.....	H-5503
Hydraulic Oil Filter.....	H-55280	Hydraulic Oil Filter.....	H-55280	Hydraulic Oil Filter.....	H-5510
Hydraulic Oil Filter.....	H-5503	Hydraulic Oil Filter.....	H-5526		
Hydraulic Oil Filter.....	H-5526	Hydraulic Oil Filter.....	H-5503	D7H (CRAWLERS) S/N: 77Z1-UP	
D7G LGP (CRAWLERS) S/N: 45W1-UP		D7H (CRAWLERS) S/N: 4FG5500-5631		Hydraulic Oil Filter.....	H-5503
Hydraulic Oil Filter.....	H-5503	Hydraulic Oil Filter.....	H-55280	Hydraulic Oil Filter.....	H-5510
Hydraulic Oil Filter.....	H-55280	Hydraulic Oil Filter.....	H-5503	Hydraulic Oil Filter.....	H-5526
Hydraulic Oil Filter.....	H-5526	Hydraulic Oil Filter.....	H-5526	Hydraulic Oil Filter.....	H-55280
D7H (CRAWLERS) S/N: 2RG1-UP		Hydraulic Oil Filter.....	H-5503	D7H (CRAWLERS) S/N: 79Z1-3999	
		Hydraulic Oil Filter.....	H-5526	Hydraulic Oil Filter.....	H-5503



ENGINE APPLICATION

MODEL/APPLICATION	SAKURA NO	MODEL/APPLICATION	SAKURA NO	MODEL/APPLICATION	SAKURA NO
CATERPILLAR		CATERPILLAR		CATERPILLAR	
D7H (CRAWLERS) S/N: 79Z1-3999		Hydraulic Oil Filter.....	H-55280	D7H LGP (CRAWLERS) S/N: 80Z1-3999	
Hydraulic Oil Filter.....	H-5510	Hydraulic Oil Filter.....	H-5503	Hydraulic Oil Filter.....	H-5510
		Hydraulic Oil Filter.....	H-5506	Hydraulic Oil Filter.....	H-5503
D7H (CRAWLERS) S/N: 79Z2304-2304		D7H (CRAWLERS) S/N: 80Z5500-5525		Hydraulic Oil Filter.....	H-5526
Hydraulic Oil Filter.....	H-5526	Hydraulic Oil Filter.....	H-5506	Hydraulic Oil Filter.....	H-5506
Hydraulic Oil Filter.....	H-55280	Hydraulic Oil Filter.....	H-55280	Hydraulic Oil Filter.....	H-55280
Hydraulic Oil Filter.....	H-5506	Hydraulic Oil Filter.....	H-5526		
D7H (CRAWLERS) S/N: 79Z2305-2315		D7H (CRAWLERS) S/N: 80Z5526-UP		D7H LGP (CRAWLERS) S/N: 82Z1-UP	
Hydraulic Oil Filter.....	H-55280	Hydraulic Oil Filter.....	H-5526	Hydraulic Oil Filter.....	H-55280
Hydraulic Oil Filter.....	H-5526	Hydraulic Oil Filter.....	H-55280	Hydraulic Oil Filter.....	H-5503
		Hydraulic Oil Filter.....	H-5506	Hydraulic Oil Filter.....	H-5526
D7H (CRAWLERS) S/N: 79Z2316-5499		D7H (CRAWLERS) S/N: 80Z641-801		Hydraulic Oil Filter.....	H-5510
Hydraulic Oil Filter.....	H-5526	Hydraulic Oil Filter.....	H-55280		
Hydraulic Oil Filter.....	H-5506	Hydraulic Oil Filter.....	H-5526	D7H LGP SERIES II (CRAWLERS) S/N: 4FG4000-UP	
Hydraulic Oil Filter.....	H-55280			Hydraulic Oil Filter.....	HC-5511
D7H (CRAWLERS) S/N: 79Z4000-UP		D7H (CRAWLERS) S/N: 80Z802-5499		Hydraulic Oil Filter.....	H-5503
Hydraulic Oil Filter.....	H-5503	Hydraulic Oil Filter.....	H-5526	Hydraulic Oil Filter.....	HC-5511
Hydraulic Oil Filter.....	H-5526	Hydraulic Oil Filter.....	H-55280	Hydraulic Oil Filter.....	H-55280
Hydraulic Oil Filter.....	H-5506	Hydraulic Oil Filter.....	H-5506	Hydraulic Oil Filter.....	H-5526
Hydraulic Oil Filter.....	H-55280	D7H (CRAWLERS) S/N: 82Z4000-UP		D7H LGP SERIES II (CRAWLERS) S/N: 5BF4000-UP	
D7H (CRAWLERS) S/N: 79Z5500-5925		Hydraulic Oil Filter.....	H-5503	Hydraulic Oil Filter.....	H-5503
Hydraulic Oil Filter.....	H-5526	Hydraulic Oil Filter.....	H-55280	Hydraulic Oil Filter.....	HC-5511
Hydraulic Oil Filter.....	H-55280	Hydraulic Oil Filter.....	H-5510	Hydraulic Oil Filter.....	H-5526
Hydraulic Oil Filter.....	H-5506	Hydraulic Oil Filter.....	H-5526	Hydraulic Oil Filter.....	H-55280
D7H (CRAWLERS) S/N: 79Z5926-UP		D7H LGP (CRAWLERS) S/N: 3XG1-UP		D7H LGP SERIES II (CRAWLERS) S/N: 79Z4000-UP	
Hydraulic Oil Filter.....	H-5526	Hydraulic Oil Filter.....	H-5503	Hydraulic Oil Filter.....	H-5503
Hydraulic Oil Filter.....	H-5506	Hydraulic Oil Filter.....	HC-5511	Hydraulic Oil Filter.....	H-5526
Hydraulic Oil Filter.....	H-55280	Hydraulic Oil Filter.....	H-5526	Hydraulic Oil Filter.....	H-5506
		Hydraulic Oil Filter.....	H-55280	Hydraulic Oil Filter.....	H-55280
D7H (CRAWLERS) S/N: 79Z745-2303		D7H LGP (CRAWLERS) S/N: 4FG1-3999		D7H LGP SERIES II (CRAWLERS) S/N: 80Z4000-UP	
Hydraulic Oil Filter.....	H-5526	Hydraulic Oil Filter.....	HC-5511	Hydraulic Oil Filter.....	H-5503
Hydraulic Oil Filter.....	H-55280	Hydraulic Oil Filter.....	H-5503	Hydraulic Oil Filter.....	H-55280
		Hydraulic Oil Filter.....	H-5526	Hydraulic Oil Filter.....	H-5506
D7H (CRAWLERS) S/N: 79ZF-3999		Hydraulic Oil Filter.....	H-55280	Hydraulic Oil Filter.....	H-5526
Hydraulic Oil Filter.....	H-5526	D7H LGP (CRAWLERS) S/N: 5BF1-3999		Hydraulic Oil Filter.....	H-55280
Hydraulic Oil Filter.....	H-5510	Hydraulic Oil Filter.....	H-5526	Hydraulic Oil Filter.....	H-5503
Hydraulic Oil Filter.....	H-55280	Hydraulic Oil Filter.....	HC-5511	Hydraulic Oil Filter.....	H-5510
Hydraulic Oil Filter.....	H-5503	Hydraulic Oil Filter.....	H-55280	D7R (CRAWLERS) S/N: 2EN1-UP	
Hydraulic Oil Filter.....	H-5506	Hydraulic Oil Filter.....	H-5503	Hydraulic Oil Filter.....	H-55280
D7H (CRAWLERS) S/N: 80Z1-3999		D7H LGP (CRAWLERS) S/N: 79Z1-3999		Hydraulic Oil Filter.....	H-5526
Hydraulic Oil Filter.....	H-5503	Hydraulic Oil Filter.....	H-5503	Hydraulic Oil Filter.....	H-55280
Hydraulic Oil Filter.....	H-5526	Hydraulic Oil Filter.....	H-5506	Hydraulic Oil Filter.....	HC-5511
Hydraulic Oil Filter.....	H-55280	Hydraulic Oil Filter.....	H-5526	Hydraulic Oil Filter.....	H-5503
Hydraulic Oil Filter.....	H-5510	Hydraulic Oil Filter.....	H-5506	Hydraulic Oil Filter.....	HC-55290
Hydraulic Oil Filter.....	H-5506	Hydraulic Oil Filter.....	H-5526	D7R (CRAWLERS) S/N: 2HR1-UP	
D7H (CRAWLERS) S/N: 80Z4000-UP		Hydraulic Oil Filter.....	H-55280	Hydraulic Oil Filter.....	H-55280
Hydraulic Oil Filter.....	H-5526	Hydraulic Oil Filter.....	H-5510	Hydraulic Oil Filter.....	H-5503



ENGINE APPLICATION

MODEL/APPLICATION	SAKURA NO	MODEL/APPLICATION	SAKURA NO	MODEL/APPLICATION	SAKURA NO
CATERPILLAR		CATERPILLAR		CATERPILLAR	
D7R (CRAWLERS) S/N: 2HR1-UP		Hydraulic Oil Filter.....	HC-55290	D7R II (CRAWLERS) S/N: AGN1500-UP	
Hydraulic Oil Filter.....	H-5526	Hydraulic Oil Filter.....	HC-5511	Hydraulic Oil Filter.....	H-5510
D7R (CRAWLERS) S/N: 3DN1-UP		Hydraulic Oil Filter.....	H-5503	D7R LGP (CRAWLERS) CAT 3176C (S/N: 3DN1-UP)	
Hydraulic Oil Filter.....	HC-55290	Hydraulic Oil Filter.....	H-5526	Hydraulic Oil Filter.....	H-5526
Hydraulic Oil Filter.....	HC-5511	Hydraulic Oil Filter.....	H-55280	Hydraulic Oil Filter.....	HC-5511
Hydraulic Oil Filter.....	H-5526	Hydraulic Oil Filter.....	H-5503	Hydraulic Oil Filter.....	H-5503
Hydraulic Oil Filter.....	H-55280	Hydraulic Oil Filter.....	H-5526	Hydraulic Oil Filter.....	H-55280
Hydraulic Oil Filter.....	H-5503	Hydraulic Oil Filter.....	H-55280	D7RXL (CRAWLERS) CAT 3306	
D7R (CRAWLERS) S/N: 3ZR1-UP		D7R II (CRAWLERS) S/N: ABJ1-1499		Hydraulic Oil Filter.....	HC-5511
Hydraulic Oil Filter.....	H-5503	Hydraulic Oil Filter.....	HC-55290	Hydraulic Oil Filter.....	H-5503
Hydraulic Oil Filter.....	H-55280	Hydraulic Oil Filter.....	HC-5511	D8 (CRAWLERS) S/N: 36A4469-4648	
Hydraulic Oil Filter.....	H-5526	Hydraulic Oil Filter.....	H-5503	Hydraulic Oil Filter.....	H-5503
D7R (CRAWLERS) S/N: 4SR1-UP		Hydraulic Oil Filter.....	H-5526	D8D (TRACTORS)	
Hydraulic Oil Filter.....	H-5526	Hydraulic Oil Filter.....	HC-55290	Hydraulic Oil Filter.....	H-5503
Hydraulic Oil Filter.....	H-55280	Hydraulic Oil Filter.....	H-5526	Hydraulic Oil Filter.....	H-5504
Hydraulic Oil Filter.....	H-5503	Hydraulic Oil Filter.....	HC-5511	D8E (TRACTORS)	
D7R (CRAWLERS) S/N: 5KZ1-UP		Hydraulic Oil Filter.....	H-55280	Hydraulic Oil Filter.....	H-5504
Hydraulic Oil Filter.....	H-55280	D7R II (CRAWLERS) S/N: ADW1-UP		D8G (TRACTORS)	
Hydraulic Oil Filter.....	HC-5511	Hydraulic Oil Filter.....	H-5503	Hydraulic Oil Filter.....	H-5504
Hydraulic Oil Filter.....	H-5526	Hydraulic Oil Filter.....	HC-55290	Hydraulic Oil Filter.....	H-5503
Hydraulic Oil Filter.....	HC-55290	Hydraulic Oil Filter.....	HC-5511	D8H (CRAWLERS) S/N: 35A1-UP	
Hydraulic Oil Filter.....	H-5503	Hydraulic Oil Filter.....	H-5526	Hydraulic Oil Filter.....	H-5504
D7R (CRAWLERS) S/N: 5MR1-UP		Hydraulic Oil Filter.....	H-55280	D8H (CRAWLERS) S/N: 68A1-UP	
Hydraulic Oil Filter.....	H-5526	D7R II (CRAWLERS) S/N: AEC1-1499		Hydraulic Oil Filter.....	H-5504
Hydraulic Oil Filter.....	H-5503	Hydraulic Oil Filter.....	H-5503	D8K (CRAWLERS) S/N: 66V1-UP	
Hydraulic Oil Filter.....	H-55280	Hydraulic Oil Filter.....	H-5526	Hydraulic Oil Filter.....	H-5503
Hydraulic Oil Filter.....	HC-5511	Hydraulic Oil Filter.....	HC-55290	D8K (CRAWLERS) S/N: 76V1-UP	
D7R (CRAWLERS) S/N: 9HM1-UP		Hydraulic Oil Filter.....	H-55280	Hydraulic Oil Filter.....	H-5503
Hydraulic Oil Filter.....	H-5526	Hydraulic Oil Filter.....	HC-5511	D8K (CRAWLERS) S/N: 77V1-UP	
Hydraulic Oil Filter.....	H-55280	D7R II (CRAWLERS) S/N: AFG1-UP		Hydraulic Oil Filter.....	H-5503
Hydraulic Oil Filter.....	H-5503	Hydraulic Oil Filter.....	H-55280	D8L (CRAWLERS) CAT 3408 (S/N: 53Y1-UP)	
D7R (CRAWLERS) S/N: ACS1-UP		Hydraulic Oil Filter.....	H-5503	Hydraulic Oil Filter.....	H-5503
Hydraulic Oil Filter.....	HC-5511	Hydraulic Oil Filter.....	H-5526	Hydraulic Oil Filter.....	H-5504
Hydraulic Oil Filter.....	H-5526	Hydraulic Oil Filter.....	HC-55290	D8L (CRAWLERS) S/N: 22A1-UP	
Hydraulic Oil Filter.....	HC-55290	Hydraulic Oil Filter.....	H-55280	Hydraulic Oil Filter.....	H-5504
Hydraulic Oil Filter.....	H-5503	Hydraulic Oil Filter.....	HC-5511	D8L (CRAWLERS) S/N: 35A1-UP	
Hydraulic Oil Filter.....	H-55280	Hydraulic Oil Filter.....	H-5526	Hydraulic Oil Filter.....	H-5504
Hydraulic Oil Filter.....	HC-5511	D7R II (CRAWLERS) S/N: AGN1-1499		D8L (CRAWLERS) S/N: 35A1-UP	
Hydraulic Oil Filter.....	H-5526	Hydraulic Oil Filter.....	HC-5511	Hydraulic Oil Filter.....	H-5504
Hydraulic Oil Filter.....	H-5503	Hydraulic Oil Filter.....	H-5526	D8L (CRAWLERS) S/N: 35A1-UP	
Hydraulic Oil Filter.....	HC-55290	Hydraulic Oil Filter.....	H-55280	Hydraulic Oil Filter.....	H-5504
Hydraulic Oil Filter.....	H-5503	Hydraulic Oil Filter.....	H-5503		
Hydraulic Oil Filter.....	H-5526	Hydraulic Oil Filter.....	HC-55290		



ENGINE APPLICATION

MODEL/APPLICATION	SAKURA NO	MODEL/APPLICATION	SAKURA NO	MODEL/APPLICATION	SAKURA NO
CATERPILLAR		CATERPILLAR		CATERPILLAR	
D8L (CRAWLERS) S/N: 36A4649-5383 Hydraulic Oil Filter.....	H-5503	Hydraulic Oil Filter.....	H-5509	D8R (CRAWLERS) CAT 3406C TA (S/N: AKA1-UP) Hydraulic Oil Filter.....	H-5526
D8L (CRAWLERS) S/N: 36A5384-5524 Hydraulic Oil Filter.....	H-5503	Hydraulic Oil Filter.....	H-55270	Hydraulic Oil Filter.....	H-5503
D8L (CRAWLERS) S/N: 36A525-UP Hydraulic Oil Filter.....	H-5503	Hydraulic Oil Filter.....	H-5504	Hydraulic Oil Filter.....	H-5510
D8L (CRAWLERS) S/N: 46A10725-12884 Hydraulic Oil Filter.....	H-5503	D8L (CRAWLERS) S/N: 7YB1573-UP Hydraulic Oil Filter.....	H-55270	D8R (CRAWLERS) Hydraulic Oil Filter.....	H-5503
D8L (CRAWLERS) S/N: 46A12885-25737 Hydraulic Oil Filter.....	H-5503	D8L (CRAWLERS) S/N: 7YB1-UP Hydraulic Oil Filter.....	H-5504	Hydraulic Oil Filter.....	H-5510
D8L (CRAWLERS) S/N: 46A25738-25740 Hydraulic Oil Filter.....	H-5503	D8N (CRAWLERS) S/N: 1XJ1-UP Hydraulic Oil Filter.....	H-5526	D8R SERIES II (CRAWLERS) CAT 3406E TA Hydraulic Oil Filter.....	H-5503
D8L (CRAWLERS) S/N: 46A25746-28136 Hydraulic Oil Filter.....	H-5503	Hydraulic Oil Filter.....	HC-5511	Hydraulic Oil Filter.....	H-55280
D8L (CRAWLERS) S/N: 46A28137-29449 Hydraulic Oil Filter.....	H-5503	Hydraulic Oil Filter.....	H-55280	D8R SERIES II (CRAWLERS) S/N: 6YZ1-UP Hydraulic Oil Filter.....	H-55270
D8L (CRAWLERS) S/N: 46A29450-UP Hydraulic Oil Filter.....	H-5503	Hydraulic Oil Filter.....	H-5503	Hydraulic Oil Filter.....	H-5526
D8L (CRAWLERS) S/N: 4FB1-UP Hydraulic Oil Filter.....	H-55270	D8N (CRAWLERS) S/N: 5TJ00754-00751 Hydraulic Oil Filter.....	H-55270	Hydraulic Oil Filter.....	H-55280
Hydraulic Oil Filter.....	H-5509	D8N (CRAWLERS) S/N: 5TJ1-UP Hydraulic Oil Filter.....	H-5510	Hydraulic Oil Filter.....	H-5510
Hydraulic Oil Filter.....	H-5504	Hydraulic Oil Filter.....	H-55270	Hydraulic Oil Filter.....	H-5503
D8L (CRAWLERS) S/N: 52A1-UP Hydraulic Oil Filter.....	H-5504	D8N (CRAWLERS) S/N: 7TK1-UP Hydraulic Oil Filter.....	H-5510	Hydraulic Oil Filter.....	H-5526
D8L (CRAWLERS) S/N: 53Y1-UP Hydraulic Oil Filter.....	H-55270	Hydraulic Oil Filter.....	H-55270	Hydraulic Oil Filter.....	H-5510
Hydraulic Oil Filter.....	H-5509	D8N (CRAWLERS) S/N: 9TC1-2453 Hydraulic Oil Filter.....	H-5526	Hydraulic Oil Filter.....	H-5510
Hydraulic Oil Filter.....	H-5504	Hydraulic Oil Filter.....	H-55280	Hydraulic Oil Filter.....	H-5503
D8L (CRAWLERS) S/N: 68A1-UP Hydraulic Oil Filter.....	H-5504	Hydraulic Oil Filter.....	H-5503	Hydraulic Oil Filter.....	HC-55170
D8L (CRAWLERS) S/N: 76V1-UP Hydraulic Oil Filter.....	H-5503	D8N (CRAWLERS) S/N: 9TC1-UP Hydraulic Oil Filter.....	H-5503	Hydraulic Oil Filter.....	H-55280
D8L (CRAWLERS) S/N: 77V1-UP Hydraulic Oil Filter.....	H-5503	Hydraulic Oil Filter.....	H-5526	D8T (CRAWLERS) S/N: 38B1-UP Hydraulic Oil Filter.....	H-5526
D8L (CRAWLERS) S/N: 73C1-UP		Hydraulic Oil Filter.....	H-5526	Hydraulic Oil Filter.....	HC-55170
		D8N (CRAWLERS) S/N: 9TC2454-UP Hydraulic Oil Filter.....	H-55280	Hydraulic Oil Filter.....	H-5503
		Hydraulic Oil Filter.....	H-5503	Hydraulic Oil Filter.....	HC-5504
		Hydraulic Oil Filter.....	H-5526	Hydraulic Oil Filter.....	H-55280
		D8R (CRAWLERS) CAT 3406C TA (S/N: 7XM1-UP) Hydraulic Oil Filter.....	H-5526	D8T (CRAWLERS) S/N: KPZ1-UP Hydraulic Oil Filter.....	H-5510
		Hydraulic Oil Filter.....	H-55270	Hydraulic Oil Filter.....	H-5526
		Hydraulic Oil Filter.....	H-55280	Hydraulic Oil Filter.....	HC-55170
		D8R (CRAWLERS) CAT 3406C TA (S/N: 9EM1-UP) Hydraulic Oil Filter.....	H-5510	Hydraulic Oil Filter.....	H-5503
		Hydraulic Oil Filter.....	H-55270	Hydraulic Oil Filter.....	HC-5504
		Hydraulic Oil Filter.....	H-55280	Hydraulic Oil Filter.....	H-55280
		D9 (CRAWLERS) S/N: 66A11908-UP Hydraulic Oil Filter.....	H-5503	D9 (CRAWLERS) S/N: 66A9418-9949 Hydraulic Oil Filter.....	H-5503
				D9 (CRAWLERS) S/N: 66A9950-11907 Hydraulic Oil Filter.....	H-5503
				D9 (CRAWLERS) S/N: 90V1-UP Hydraulic Oil Filter.....	H-5503



ENGINE APPLICATION

MODEL/APPLICATION	SAKURA NO	MODEL/APPLICATION	SAKURA NO	MODEL/APPLICATION	SAKURA NO
CATERPILLAR		CATERPILLAR		CATERPILLAR	
D9R (CRAWLERS) CAT 3408E TA (S/N: ACL1-UP)		E200B (EXCAVATORS) MITSUBISHI 56K-T (S/N: 6KF1-00233-UP)		E300B (EXCAVATORS) CAT 3306T (S/N: 3FJ1-UP)	
Hydraulic Oil Filter.....	H-55270	Hydraulic Oil Filter.....	H-5505	Hydraulic Oil Filter.....	HC-5801
Hydraulic Oil Filter.....	H-5504			Hydraulic Oil Filter.....	H-5505
D9T (DOZERS) CAT S/N: RHX1-UP , 2008-UP		E200B (EXCAVATORS) MITSUBISHI 56K-T (S/N: 7DF1-UP)		E450 (EXCAVATORS) MITSUBISHI 4D32 DIESEL (S/N: 3HG9201-UP)	
Hydraulic Oil Filter.....	HC-55170	Hydraulic Oil Filter.....	H-5505	Hydraulic Oil Filter.....	HC-5801
Hydraulic Oil Filter.....	H-5506				
D9T (DOZERS) CAT S/N: RJS1-689-UP , 2008-UP		E200B (EXCAVATORS) S/N: 6KF1-UP		E450 (EXCAVATORS) MITSUBISHI 6D22TC (S/N: 3HG1-UP)	
Hydraulic Oil Filter.....	H-5506	Hydraulic Oil Filter.....	HC-5801	Hydraulic Oil Filter.....	H-5505
Hydraulic Oil Filter.....	HC-55170	Hydraulic Oil Filter.....	H-5505	Hydraulic Oil Filter.....	HC-5801
D9T (DOZERS) CAT S/N: RJS690-UP , 2008-UP		E240 (EXCAVATORS) CAT 3304 (S/N: 1FG1-UP)		E650 (EXCAVATORS) MITSUBISHI 56B-TA (S/N: 3KG1-UP)	
Hydraulic Oil Filter.....	H-5506	Hydraulic Oil Filter.....	H-5505	Hydraulic Oil Filter.....	H-5505
		Hydraulic Oil Filter.....	HC-5801	Hydraulic Oil Filter.....	HC-5801
E110 (EXCAVATORS) MITSUBISHI 4D31T (S/N: 3FG1-UP)		E240 (EXCAVATORS) CAT 3304 (S/N: 4JF1-UP)		E70 3BG-ON (EXCAVATORS) w/Mitsubishi 4D31 Eng	
Hydraulic Oil Filter.....	HC-5801	Hydraulic Oil Filter.....	H-5505	Hydraulic Oil Filter.....	H-5519
E110B (EXCAVATORS) MITSUBISHI 54K-T (S/N: 8MF1-UP)		E240 (EXCAVATORS) MITSUBISHI 4D32 DIESEL (S/N: 1FG1-UP)		E70B 5TG-ON (EXCAVATORS) w/Mitsubishi 4D32 Eng	
Hydraulic Oil Filter.....	HC-5801	Hydraulic Oil Filter.....	H-5505	Hydraulic Oil Filter.....	H-5519
E120 (EXCAVATORS) MITSUBISHI 4D32 DIESEL (S/N: 1LF9251-UP)		E240/EL240 (EXCAVATORS) S/N: 4JF1-UP		EL180 (EXCAVATORS) S/N: 1RF1-100	
Hydraulic Oil Filter.....	HC-5801	Hydraulic Oil Filter.....	HC-5801	Hydraulic Oil Filter.....	HC-5801
E120 (EXCAVATORS) MITSUBISHI 6D14 (S/N: 1LF1-UP)		E240B (EXCAVATORS) CAT 3116 (S/N: 5WG1-UP) , TO-2001		EL180 (EXCAVATORS) S/N: 4EF101-UP	
Hydraulic Oil Filter.....	HC-5801	Hydraulic Oil Filter.....	H-5505	Hydraulic Oil Filter.....	HC-5801
E120B (EXCAVATORS) MITSUBISHI 54K-T (S/N: 6JF1-UP)		E240B (EXCAVATORS) CAT 3116 (S/N: 8SF1-UP)		EL180 (EXCAVATORS) S/N: 4EF1-100	
Hydraulic Oil Filter.....	HC-5801	Hydraulic Oil Filter.....	H-5505	Hydraulic Oil Filter.....	HC-5801
E140 (EXCAVATORS) MITSUBISHI 4D32 DIESEL (S/N: 1NF9011-UP)		Hydraulic Oil Filter.....	HC-5801	EL200B (EXCAVATORS) MITSUBISHI 56K-T (S/N: 7DF00688-UP)	
Hydraulic Oil Filter.....	HC-5801	E240C (EXCAVATORS) CAT 3116 (S/N: 2RL1-UP)		Hydraulic Oil Filter.....	HC-5801
E140 (EXCAVATORS) MITSUBISHI 6D14 (S/N: 1NF09041-UP)		Hydraulic Oil Filter.....	H-5505	EL200B (EXCAVATORS) S/N: 6FK1-UP	
Hydraulic Oil Filter.....	HC-5801	E240C (EXCAVATORS) CAT 3116 (S/N: 9PK1-UP)		Hydraulic Oil Filter.....	H-5505
E180 (EXCAVATORS) CAT 3204 (S/N: 1RF1-UP)		Hydraulic Oil Filter.....	H-5505	Hydraulic Oil Filter.....	HC-5801
Hydraulic Oil Filter.....	H-5505	E300 (EXCAVATORS) CAT 3306 (S/N: 2CF1-UP)		EL200B (EXCAVATORS) S/N: 7DF1-UP	
Hydraulic Oil Filter.....	HC-5801	Hydraulic Oil Filter.....	HC-5801	Hydraulic Oil Filter.....	HC-5801
E180 (EXCAVATORS) CAT 3204 (S/N: 4EF1-UP)		Hydraulic Oil Filter.....	H-5505	EL240B (EXCAVATORS) CAT 3116 (S/N: 5WG1-UP)	
Hydraulic Oil Filter.....	H-5505	E300 (EXCAVATORS) CAT 3306 (S/N: 4NF1-UP)		Hydraulic Oil Filter.....	HC-5801
E180 (EXCAVATORS) MITSUBISHI 4D32 DIESEL (S/N: 1RF101-UP)		Hydraulic Oil Filter.....	H-5505	Hydraulic Oil Filter.....	H-5505
Hydraulic Oil Filter.....	HC-5801	E300B (EXCAVATORS) MITSUBISHI 4D32 DIESEL (S/N: 2CF101-UP)		EL240B (EXCAVATORS) CAT 3116 (S/N: 8SF1-UP)	
E200B (EXCAVATORS) MITSUBISHI 56K-T (S/N: 6KF00234-UP)		Hydraulic Oil Filter.....	HC-5801	Hydraulic Oil Filter.....	H-5505
Hydraulic Oil Filter.....	HC-5801	E300B (EXCAVATORS) CAT 3306T (S/N: 1WJ1-UP)		EL300 (EXCAVATORS) CAT 3306 (S/N: 2CF1-UP)	
Hydraulic Oil Filter.....	H-5505	Hydraulic Oil Filter.....	H-5505	Hydraulic Oil Filter.....	HC-5801
		Hydraulic Oil Filter.....	HC-5801	Hydraulic Oil Filter.....	H-5505



ENGINE APPLICATION

MODEL/APPLICATION	SAKURA NO	MODEL/APPLICATION	SAKURA NO	MODEL/APPLICATION	SAKURA NO
CATERPILLAR		CATERPILLAR		CATERPILLAR	
EL300 (EXCAVATORS) CAT 3306 (S/N: 4NF1-UP)		IT12F (INTEGRATED TOOL-CARRIERS) CAT 3054 (S/N: 1KF1-UP)		IT12 (INTEGRATED TOOL-CARRIERS) S/N: 4NC1-UP	
Hydraulic Oil Filter.....	HC-5801	Hydraulic Oil Filter.....	H-5510	Hydraulic Oil Filter.....	H-55270
Hydraulic Oil Filter.....	H-5505			Hydraulic Oil Filter.....	H-5504
EL70B 5TG-ON (EXCAVATORS) w/Mitsubishi 4D32 Eng		IT12F (INTEGRATED TOOL-CARRIERS) S/N: 1KF820-UP		IT12B (INTEGRATED TOOL-CARRIERS) S/N: 1KF1-UP	
Hydraulic Oil Filter.....	H-5519	Hydraulic Oil Filter.....	HC-5504	Hydraulic Oil Filter.....	H-5510
		Hydraulic Oil Filter.....	H-5510	Hydraulic Oil Filter.....	HC-5504
G916 (LOADERS) S/N: 15D-UP		IT14G (INTEGRATED TOOL-CARRIERS) CAT 3054 (S/N: 1WN01379-UP)		IT14B (INTEGRATED TOOL-CARRIERS) CAT 3114 (S/N: 3NJ1-UP)	
Hydraulic Oil Filter.....	H-5506	Hydraulic Oil Filter.....	HC-5504	Hydraulic Oil Filter.....	H-5510
G916 (LOADERS) S/N: 5GD1-45-UP		IT14G (INTEGRATED TOOL-CARRIERS) CAT 3054 (S/N: 1MN1-659)		IT14B (INTEGRATED TOOL-CARRIERS) CAT 3114 (S/N: 9SF1-UP)	
Hydraulic Oil Filter.....	H-5501	Hydraulic Oil Filter.....	HC-5504	Hydraulic Oil Filter.....	H-5510
Hydraulic Oil Filter.....	H-5506			Hydraulic Oil Filter.....	H-5510
G916 (LOADERS) S/N: 5GD1-47		IT14G (INTEGRATED TOOL-CARRIERS) CAT 3054 (S/N: 1WN660-1378)		IT14F (INTEGRATED TOOL-CARRIERS) S/N: 4EL1-UP	
Hydraulic Oil Filter.....	H-5506	Hydraulic Oil Filter.....	HC-5504	Hydraulic Oil Filter.....	H-5510
G916 (LOADERS) S/N: 5GD46-UP		IT14G (INTEGRATED TOOL-CARRIERS) CAT 3054 (S/N: 8ZM1-331)		Hydraulic Oil Filter.....	HC-5504
Hydraulic Oil Filter.....	H-5501	Hydraulic Oil Filter.....	HC-5504	IT14G US (INTEGRATED TOOL-CARRIERS) CAT 3054 (S/N: 8ZM1-UP)	
Hydraulic Oil Filter.....	H-5506			Hydraulic Oil Filter.....	HC-5504
G916 (LOADERS) S/N: 5GD-UP		IT14G (INTEGRATED TOOL-CARRIERS) CAT 3054 (S/N: 8ZM332-UP)		IT18 (INTEGRATED TOOL-CARRIERS) CAT 3204 (S/N: 7ZB1-UP) , 2005-UP	
Hydraulic Oil Filter.....	H-5506	Hydraulic Oil Filter.....	HC-5504	Hydraulic Oil Filter.....	H-5506
G916 (LOADERS) S/N: 8GD-UP		IT14G (INTEGRATED TOOL-CARRIERS) CAT 3054C DIT (S/N: 1WN660-UP)		IT18 (INTEGRATED TOOL-CARRIERS) CAT 3204 (S/N: 9NB1-UP) , 2005-UP	
Hydraulic Oil Filter.....	H-5506	Hydraulic Oil Filter.....	HC-5504	Hydraulic Oil Filter.....	H-5506
G910 (LOADERS) S/N: 3SD1-UP		IT18F (INTEGRATED TOOL-CARRIERS) CAT 3114 (S/N: 5EJ1-UP) , 2005-UP		IT18 (INTEGRATED TOOL-CARRIERS) S/N: 4ZD-UP	
Hydraulic Oil Filter.....	H-55270	Hydraulic Oil Filter.....	H-5506	Hydraulic Oil Filter.....	H-55270
Hydraulic Oil Filter.....	H-5504	Hydraulic Oil Filter.....	HC-5504	IT18 (INTEGRATED TOOL-CARRIERS) S/N: 9NB1-9NB1	
G910 (LOADERS) S/N: 8GD1-UP		IT18F (INTEGRATED TOOL-CARRIERS) CAT 3114 (S/N: 6ZF1-UP) , 2005-UP		Hydraulic Oil Filter.....	H-5506
Hydraulic Oil Filter.....	H-55270	Hydraulic Oil Filter.....	H-5506	IT18B (INTEGRATED TOOL-CARRIERS) CAT 3204 (S/N: 1DF1-UP) , 2005-UP	
Hydraulic Oil Filter.....	H-5504	Hydraulic Oil Filter.....	HC-5504	Hydraulic Oil Filter.....	H-5506
G936 (LOADERS) S/N: 3HD1-UP		IT18F (INTEGRATED TOOL-CARRIERS) CAT 3114 (S/N: 8GJ1-UP) , 2005-UP		IT18B (INTEGRATED TOOL-CARRIERS) CAT 3204 (S/N: 2NJ340-UP) , 2005-UP	
Hydraulic Oil Filter.....	H-5506	Hydraulic Oil Filter.....	H-5506	Hydraulic Oil Filter.....	H-5506
G936 (LOADERS) S/N: 4ND1-UP		IT18F (INTEGRATED TOOL-CARRIERS) S/N: 5EJ1-UP		IT18B (INTEGRATED TOOL-CARRIERS) CAT 3204 (S/N: 4ZD1-UP)	
Hydraulic Oil Filter.....	H-5506	Hydraulic Oil Filter.....	HC-5508	Hydraulic Oil Filter.....	H-5506
G936 (LOADERS) S/N: 45B-UP		Hydraulic Oil Filter.....	H-5506	IT18B (INTEGRATED TOOL-CARRIERS) S/N: 1DF1-UP	
Hydraulic Oil Filter.....	H-5506			Hydraulic Oil Filter.....	H-5506
G936 (LOADERS) S/N: 45Z-UP		IT18F (INTEGRATED TOOL-CARRIERS) S/N: 6ZF1-UP		IT18B (INTEGRATED TOOL-CARRIERS) S/N: 1DF-UP	
Hydraulic Oil Filter.....	H-5506	Hydraulic Oil Filter.....	HC-5508	Hydraulic Oil Filter.....	H-5506
G936 (LOADERS) S/N: 8ED1-UP		Hydraulic Oil Filter.....	H-5506	Hydraulic Oil Filter.....	H-5506
Hydraulic Oil Filter.....	H-5506			IT18B (INTEGRATED TOOL-CARRIERS) S/N: 2NJ340-UP	
		IT12 (INTEGRATED TOOL-CARRIERS) S/N: 2YC1-UP		Hydraulic Oil Filter.....	H-5506
		Hydraulic Oil Filter.....	H-5504	IT18B (INTEGRATED TOOL-CARRIERS) S/N: 2NJ340-UP	
		Hydraulic Oil Filter.....	H-55270	Hydraulic Oil Filter.....	H-5506



ENGINE APPLICATION

MODEL/APPLICATION	SAKURA NO	MODEL/APPLICATION	SAKURA NO	MODEL/APPLICATION	SAKURA NO
CATERPILLAR		CATERPILLAR		CATERPILLAR	
IT18B (INTEGRATED TOOL-CARRIERS) S/N: 2NS-UP		IT28G (INTEGRATED TOOL-CARRIERS) CAT 3056E		IT28G US (INTEGRATED TOOL-CARRIERS) CAT 3056E (S/N: 8CR1-UP) , 2005-UP	
Hydraulic Oil Filter.....	H-5506	Hydraulic Oil Filter.....	HC-5504	Hydraulic Oil Filter.....	HC-5504
IT18B (INTEGRATED TOOL-CARRIERS) S/N: 4ZD-UP		IT24F (INTEGRATED TOOL-CARRIERS) CAT 3114 (S/N: 4NN1-UP)		Hydraulic Oil Filter.....	H-5506
Hydraulic Oil Filter.....	H-5506	Hydraulic Oil Filter.....	HC-5504	IT38F (INTEGRATED TOOL-CARRIERS) CAT 3116 (S/N: 5DR1-270) , 2005-UP	
IT28 (INTEGRATED TOOL-CARRIERS) CAT 3204 (S/N: 2KC1-UP) , 2005-UP		Hydraulic Oil Filter.....	H-5506	Hydraulic Oil Filter.....	H-5506
Hydraulic Oil Filter.....	H-5506	IT24F (INTEGRATED TOOL-CARRIERS) CAT 3114 (S/N: 6KN1-UP)		Hydraulic Oil Filter.....	HC-5504
IT28 (INTEGRATED TOOL-CARRIERS) CAT 3204 (S/N: 8JB1-UP) , 2005-UP		Hydraulic Oil Filter.....	H-5506	IT38F (INTEGRATED TOOL-CARRIERS) CAT 3116 (S/N: 5DR271-UP) , 2005-UP	
Hydraulic Oil Filter.....	H-5506	Hydraulic Oil Filter.....	HC-5504	Hydraulic Oil Filter.....	H-5506
IT28 (INTEGRATED TOOL-CARRIERS) S/N: 1HF1-UP		IT24F (INTEGRATED TOOL-CARRIERS) S/N: 4NN1-UP		Hydraulic Oil Filter.....	HC-5504
Hydraulic Oil Filter.....	H-5506	Hydraulic Oil Filter.....	H-5506	IT38F (INTEGRATED TOOL-CARRIERS) CAT 3116 (S/N: 6FN1-UP) , 2005-UP	
IT28 (INTEGRATED TOOL-CARRIERS) S/N: 2KC1-UP		Hydraulic Oil Filter.....	HC-5508	Hydraulic Oil Filter.....	HC-5504
Hydraulic Oil Filter.....	H-5506	IT24F (INTEGRATED TOOL-CARRIERS) S/N: 6KN1-UP		Hydraulic Oil Filter.....	H-5506
IT28 (INTEGRATED TOOL-CARRIERS) S/N: 5SD1-UP		Hydraulic Oil Filter.....	H-5506	IT38F (INTEGRATED TOOL-CARRIERS) S/N: 6NF1-UP	
Hydraulic Oil Filter.....	H-5506	Hydraulic Oil Filter.....	HC-5508	Hydraulic Oil Filter.....	HC-5508
IT28B (INTEGRATED TOOL-CARRIERS) CAT 3204 (S/N: 5SD1-UP)		IT24F UK (INTEGRATED TOOL-CARRIERS) CAT 3056E (S/N: 6KN1-UP) , 2005-UP		Hydraulic Oil Filter.....	H-5506
Hydraulic Oil Filter.....	H-5506	Hydraulic Oil Filter.....	H-5506	Hydraulic Oil Filter.....	HC-5504
IT28B (INTEGRATED TOOL-CARRIERS) S/N: 17K430-UP		Hydraulic Oil Filter.....	HC-5504	IT38G (INTEGRATED TOOL-CARRIERS) CAT 3126 (S/N: 1CW1-328) , 2005-UP	
Hydraulic Oil Filter.....	H-5506	IT28F (INTEGRATED TOOL-CARRIERS) CAT 3116 (S/N: 1JL1-UP) , 2005-UP		Hydraulic Oil Filter.....	H-5506
IT28B (INTEGRATED TOOL-CARRIERS) S/N: 17K430-UP		Hydraulic Oil Filter.....	HC-5504	Hydraulic Oil Filter.....	HC-5504
Hydraulic Oil Filter.....	H-5506	Hydraulic Oil Filter.....	H-5506	IT38G (INTEGRATED TOOL-CARRIERS) CAT 3126 (S/N: 1CW329-UP) , 2005-UP	
IT28B (INTEGRATED TOOL-CARRIERS) S/N: 5SD1302-UP		IT28F (INTEGRATED TOOL-CARRIERS) CAT 3116 (S/N: 3CL1-1199) , 2005-UP		Hydraulic Oil Filter.....	HC-5504
Hydraulic Oil Filter.....	H-5506	Hydraulic Oil Filter.....	HC-5504	Hydraulic Oil Filter.....	H-5506
IT28G (INTEGRATED TOOL-CARRIERS) CAT 3116 (S/N: 8CR1-UP) , 2005-UP		Hydraulic Oil Filter.....	H-5506	IT38G (INTEGRATED TOOL-CARRIERS) S/N: 1CW329-UP	
Hydraulic Oil Filter.....	HC-5504	Hydraulic Oil Filter.....	HC-5508	Hydraulic Oil Filter.....	H-5506
IT28G (INTEGRATED TOOL-CARRIERS) CAT 3116 (S/N: 9AR1-UP) , 2005-UP		IT28F (INTEGRATED TOOL-CARRIERS) S/N: 1JL1-UP		Hydraulic Oil Filter.....	HC-5504
Hydraulic Oil Filter.....	HC-5504	Hydraulic Oil Filter.....	H-5506	IT38G (INTEGRATED TOOL-CARRIERS) CAT 3126 (S/N: CSX1-UP) , 2005-UP	
IT28G (INTEGRATED TOOL-CARRIERS) CAT 3116 (S/N: DBT1-UP) , 2005-UP		Hydraulic Oil Filter.....	HC-5504	Hydraulic Oil Filter.....	H-5506
Hydraulic Oil Filter.....	HC-5504	IT28F (INTEGRATED TOOL-CARRIERS) S/N: 3CL1200-UP		Hydraulic Oil Filter.....	HC-5504
IT28G (INTEGRATED TOOL-CARRIERS) CAT 3116 (S/N: WAC1-UP) , 2005-UP		Hydraulic Oil Filter.....	H-5506	IT38G (INTEGRATED TOOL-CARRIERS) S/N: 7BS1-UP	
Hydraulic Oil Filter.....	HC-5504	Hydraulic Oil Filter.....	HC-5504	Hydraulic Oil Filter.....	H-5506
IT28G (INTEGRATED TOOL-CARRIERS) CAT 3116 (S/N: DBT1-UP) , 2005-UP		IT28F (INTEGRATED TOOL-CARRIERS) S/N: 3CL1-UP		Hydraulic Oil Filter.....	HC-5504
Hydraulic Oil Filter.....	HC-5504	Hydraulic Oil Filter.....	H-5506	IT38G II (INTEGRATED TOOL-CARRIERS) S/N: CSX1-UP	
IT28G (INTEGRATED TOOL-CARRIERS) CAT 3116 (S/N: WAC1-UP) , 2005-UP		Hydraulic Oil Filter.....	HC-5508	Hydraulic Oil Filter.....	HC-5504
Hydraulic Oil Filter.....	HC-5504	IT28G EN (INTEGRATED TOOL-CARRIERS) CAT 3056E (S/N: 9AR1-UP)		Hydraulic Oil Filter.....	H-5506
IT28G (INTEGRATED TOOL-CARRIERS) CAT 3116		Hydraulic Oil Filter.....	H-5506	Hydraulic Oil Filter.....	HC-5504
Hydraulic Oil Filter.....	HC-5504	Hydraulic Oil Filter.....	HC-5504		



ENGINE APPLICATION

MODEL/APPLICATION	SAKURA NO	MODEL/APPLICATION	SAKURA NO	MODEL/APPLICATION	SAKURA NO
CATERPILLAR		CATERPILLAR		CATERPILLAR	
IT38G II (INTEGRATED TOOL-CARRIERS) S/N: JAN1-UP Hydraulic Oil Filter..... H-5506 Hydraulic Oil Filter..... HC-5504		M325D (EXCAVATORS) S/N: EDC1-UP Hydraulic Oil Filter..... H-5522 Hydraulic Oil Filter..... HC-5801		PF-300B (PAVING EQUIPMENT) S/N: 6HM83-195-UP Hydraulic Oil Filter..... HC-5504	
IT38H (INTEGRATED TOOL-CARRIERS) w/C6.6 Eng. Hydraulic Oil Filter..... HC-55280		M325D (EXCAVATORS) S/N: EDF1-UP Hydraulic Oil Filter..... H-5522 Hydraulic Oil Filter..... HC-5801		PF300 (PAVING EQUIPMENT) S/N: 7WD1-UP Hydraulic Oil Filter..... HC-7913	
IT62G (INTEGRATED TOOL-CARRIERS) CAT 3126 (S/N: 6PS1-UP) , 2005-UP Hydraulic Oil Filter..... HC-5504		M325D (EXCAVATORS) S/N: KAE1-UP Hydraulic Oil Filter..... H-5522 Hydraulic Oil Filter..... HC-5801		PM-201 (PAVING EQUIPMENT) CAT S/N: PNM1-UP Hydraulic Oil Filter..... H-55270 Hydraulic Oil Filter..... HC-5504	
IT62G (INTEGRATED TOOL-CARRIERS) CAT 3126 (S/N: AKP1-UP) , 2005-UP Hydraulic Oil Filter..... HC-5504		M325D (EXCAVATORS) S/N: KAY1-UP Hydraulic Oil Filter..... HC-5801 Hydraulic Oil Filter..... H-5522		PM-201 (PAVING EQUIPMENT) CAT S/N: RHX1-UP Hydraulic Oil Filter..... HC-5504 Hydraulic Oil Filter..... H-55270	
IT62G (INTEGRATED TOOL-CARRIERS) CAT 3126 (S/N: AYA1-UP) , 2005-UP Hydraulic Oil Filter..... HC-5504		M325D (EXCAVATORS) S/N: KGG1-UP Hydraulic Oil Filter..... H-5522 Hydraulic Oil Filter..... HC-5801		PM-465 (ASPHALT FINISHERS) CAT S/N: 41Z4926-UP , 2004-UP Hydraulic Oil Filter..... HC-5504 Hydraulic Oil Filter..... HC-5503 Hydraulic Oil Filter..... HC-5512 Hydraulic Oil Filter..... HC-5506	
IT62G II (INTEGRATED TOOL-CARRIERS) S/N: AKP1-UP Hydraulic Oil Filter..... HC-5504		M325D (EXCAVATORS) S/N: KGG212-UP Hydraulic Oil Filter..... HC-5801 Hydraulic Oil Filter..... H-5522		PM-465 (ASPHALT FINISHERS) CAT S/N: 5ZS146-UP , 2004-UP Hydraulic Oil Filter..... HC-5504 Hydraulic Oil Filter..... HC-5506 Hydraulic Oil Filter..... HC-5512 Hydraulic Oil Filter..... HC-5503	
IT62H (INTEGRATED TOOL-CARRIERS) CAT S/N: C7C1-UP Hydraulic Oil Filter..... HC-5504		M325B MH (MATERIAL HANDLERS) CAT 3056 (S/N: BGN1-UP) Hydraulic Oil Filter..... HC-5505 Hydraulic Oil Filter..... HC-5801 Hydraulic Oil Filter..... H-7942		PM-565B (PAVING EQUIPMENT) CAT 3408E HEUI Hydraulic Oil Filter..... H-5504 Hydraulic Oil Filter..... HC-5504 Hydraulic Oil Filter..... H-55270	
IT62H (INTEGRATED TOOL-CARRIERS) CAT S/N: M5G1-UP Hydraulic Oil Filter..... HC-5504		(ENGINES) CAT 345 B Hydraulic Oil Filter..... HC-5801 Hydraulic Oil Filter..... H-7942		PM800 (PAVING EQUIPMENT) Hydraulic Oil Filter..... H-5517	
IT62H (INTEGRATED TOOL-CARRIERS) w/C7 Eng. Hydraulic Oil Filter..... HC-55280		(ENGINES) CAT 345 BL Hydraulic Oil Filter..... HC-5801 Hydraulic Oil Filter..... H-7942		PR105 (PAVING EQUIPMENT) S/N: 5NC1-UP Hydraulic Oil Filter..... H-51170 Hydraulic Oil Filter..... H-79411	
M325C (EXCAVATORS) CAT S/N: BMA1-UP Hydraulic Oil Filter..... HC-55170 Hydraulic Oil Filter..... H-7942 Hydraulic Oil Filter..... HC-5801 Hydraulic Oil Filter..... H-5522		(ENGINES) CAT D330 (S/N: 9VA1-UP) Hydraulic Oil Filter..... H-5504 Hydraulic Oil Filter..... H-5503		PS-150B (PAVING EQUIPMENT) S/N: 3XR1-69 Hydraulic Oil Filter..... HC-5504	
M325C (EXCAVATORS) CAT S/N: PAN1-UP Hydraulic Oil Filter..... HC-5801 Hydraulic Oil Filter..... HC-55170 Hydraulic Oil Filter..... H-5522 Hydraulic Oil Filter..... H-7942		(ENGINES) CAT D330C (S/N: 5B1-UP) Hydraulic Oil Filter..... H-5503 Hydraulic Oil Filter..... H-5504		PS-150C (PAVING EQUIPMENT) CAT S/N: CRS1600-UP Hydraulic Oil Filter..... HC-5504	
M325C (EXCAVATORS) CAT S/N: XJA1-UP Hydraulic Oil Filter..... H-5522 Hydraulic Oil Filter..... H-7942 Hydraulic Oil Filter..... HC-55170 Hydraulic Oil Filter..... HC-5801		(EXCAVATORS) CAT 3406 Hydraulic Oil Filter..... HC-5511 Hydraulic Oil Filter..... H-5505		PS-150C (PAVING EQUIPMENT) CAT S/N: FPS1-UP Hydraulic Oil Filter..... HC-5504	
		PF-290B (PAVING EQUIPMENT) CAT 3054 Hydraulic Oil Filter..... HC-5504		PS-200B (PAVING EQUIPMENT) CAT 3054 Hydraulic Oil Filter..... HC-5504	
				PS-300B (PAVING EQUIPMENT) CAT 3054T (S/N: 4NP81-UP)	



ENGINE APPLICATION

MODEL/APPLICATION	SAKURA NO	MODEL/APPLICATION	SAKURA NO	MODEL/APPLICATION	SAKURA NO
CATERPILLAR		CATERPILLAR		CATERPILLAR	
PS-300B (PAVING EQUIPMENT) CAT 3054T (S/N: 4NP81-UP) Hydraulic Oil Filter.....	HC-5504	Hydraulic Oil Filter.....	HC-5501	Hydraulic Oil Filter.....	HC-5507
PS-300B (PAVING EQUIPMENT) CAT 3054T (S/N: 6HM1-UP) Hydraulic Oil Filter.....	HC-5504	RH62 (HANDLER TELESCOPIC) PERKINS Hydraulic Oil Filter.....	HC-5506	RM-500 (PAVING EQUIPMENT) CAT S/N: ASW110-UP , 2006-UP Hydraulic Oil Filter.....	HC-5506
PS-360C (PAVING EQUIPMENT) CAT S/N: CRS2700-UP Hydraulic Oil Filter.....	HC-5504	Hydraulic Oil Filter.....	HC-5503	Hydraulic Oil Filter.....	H-5517
PS-360C (PAVING EQUIPMENT) CAT S/N: G4D1-UP Hydraulic Oil Filter.....	HC-5504	RH82 (HANDLER TELESCOPIC) PERKINS Hydraulic Oil Filter.....	HC-5503	Hydraulic Oil Filter.....	HC-5503
PS-360C (PAVING EQUIPMENT) CAT S/N: PJF1-UP Hydraulic Oil Filter.....	HC-5504	Hydraulic Oil Filter.....	HC-5506	Hydraulic Oil Filter.....	HC-5512
PS300 (PAVING EQUIPMENT) DEUTZ F6L912 Hydraulic Oil Filter.....	HC-7913	RM-300 (PAVING EQUIPMENT) CAT S/N: BWR1-UP Hydraulic Oil Filter.....	HC-5507	Hydraulic Oil Filter.....	HC-5507
PS300 (PAVING EQUIPMENT) S/N: 7TD1-UP Hydraulic Oil Filter.....	HC-7913	Hydraulic Oil Filter.....	H-5517	Hydraulic Oil Filter.....	HC-55220
R40 THRU RC60 (FORKLIFTS) PERKINS 4.236 (S/N: 16A-UP) Hydraulic Oil Filter.....	HC-5501	Hydraulic Oil Filter.....	HC-55220	Hydraulic Oil Filter.....	HC-5503
Hydraulic Oil Filter.....	H-5517	RM-300 (PAVING EQUIPMENT) CAT S/N: RSX1-UP Hydraulic Oil Filter.....	HC-5507	Hydraulic Oil Filter.....	HC-5512
R40 THRU RC60 (FORKLIFTS) PERKINS 4.236 (S/N: 26A-UP) Hydraulic Oil Filter.....	HC-5501	Hydraulic Oil Filter.....	H-5517	Hydraulic Oil Filter.....	H-5517
Hydraulic Oil Filter.....	H-5517	RM-350B (PAVING EQUIPMENT) CAT 3406C Hydraulic Oil Filter.....	HC-5516	Hydraulic Oil Filter.....	HC-5506
R40 THRU RC60 (FORKLIFTS) PERKINS 4.236 DIESEL (S/N: 21A-UP) Hydraulic Oil Filter.....	H-5517	Hydraulic Oil Filter.....	HC-5516	RR250B (PAVING EQUIPMENT) Hydraulic Oil Filter.....	H-5517
Hydraulic Oil Filter.....	HC-5501	RM350 (PAVING EQUIPMENT) CAT S/N: 11N7919-UP Hydraulic Oil Filter.....	HC-5507	Hydraulic Oil Filter.....	HC-5501
R40 THRU RC60 (FORKLIFTS) PERKINS 4.236 DIESEL (S/N: 31A-UP) Hydraulic Oil Filter.....	H-5517	Hydraulic Oil Filter.....	HC-5516	RT40 THRU RTC60 (FORKLIFTS) PERKINS 4.236 DIESEL (S/N: 4XG-UP) Hydraulic Oil Filter.....	HC-5501
Hydraulic Oil Filter.....	HC-5501	Hydraulic Oil Filter.....	H-5517	Hydraulic Oil Filter.....	H-5517
R60 THRU R80 (FORKLIFTS) PERKINS 4.236 (S/N: 32A-UP) Hydraulic Oil Filter.....	H-5517	Hydraulic Oil Filter.....	HC-55300	RT50 (HANDLER TELESCOPIC) S/N: 4XG1-UP Hydraulic Oil Filter.....	HC-5501
Hydraulic Oil Filter.....	HC-5501	Hydraulic Oil Filter.....	HC-5516	Hydraulic Oil Filter.....	HC-5501
R60 THRU R80 (FORKLIFTS) PERKINS 4.236 (S/N: 38A-38A) Hydraulic Oil Filter.....	HC-5501	RM350 (PAVING EQUIPMENT) CAT S/N: 412257-UP Hydraulic Oil Filter.....	HC-5507	RT50/SA (HANDLER TELESCOPIC) Hydraulic Oil Filter.....	HC-5501
Hydraulic Oil Filter.....	H-5517	Hydraulic Oil Filter.....	HC-55300	RT505A (HANDLER TELESCOPIC) Hydraulic Oil Filter.....	HC-5501
R60 THRU R80 (FORKLIFTS) PERKINS 4.236 (S/N: 39A-UP) Hydraulic Oil Filter.....	H-5517	Hydraulic Oil Filter.....	H-5506	RT60 (FORKLIFTS) PERKINS 4.236 DIESEL (S/N: 5DG-UP) Hydraulic Oil Filter.....	H-5517
Hydraulic Oil Filter.....	HC-5501	Hydraulic Oil Filter.....	HC-5507	Hydraulic Oil Filter.....	HC-5501
R60 THRU R80 (FORKLIFTS) PERKINS 4.236 DIESEL (S/N: 1KK-UP) Hydraulic Oil Filter.....	H-5517	RM350 (PAVING EQUIPMENT) CAT S/N: 5FK104-UP Hydraulic Oil Filter.....	HC-55220	RT80 (HANDLER TELESCOPIC) S/N: 3JN1-UP Hydraulic Oil Filter.....	HC-5503
Hydraulic Oil Filter.....	H-5517	Hydraulic Oil Filter.....	H-5517	Hydraulic Oil Filter.....	HC-5503
		Hydraulic Oil Filter.....	HC-5516	RT80 (HANDLER TELESCOPIC) S/N: 3NN1-UP Hydraulic Oil Filter.....	HC-5503
		Hydraulic Oil Filter.....	HC-5507	Hydraulic Oil Filter.....	HC-5503
		Hydraulic Oil Filter.....	H-5517	RT80 (HANDLER TELESCOPIC) S/N: 3RN1-UP Hydraulic Oil Filter.....	HC-5503
		Hydraulic Oil Filter.....	HC-55220	Hydraulic Oil Filter.....	HC-5503
		RM350 (PAVING EQUIPMENT) CAT S/N: 5FK41-103-UP Hydraulic Oil Filter.....	H-5517	RT80 (HANDLER TELESCOPIC) S/N: 5WM1-UP Hydraulic Oil Filter.....	HC-5503
		Hydraulic Oil Filter.....	HC-55220	Hydraulic Oil Filter.....	H-5504
		Hydraulic Oil Filter.....	H-5517		
		Hydraulic Oil Filter.....	HC-55220		



ENGINE APPLICATION

MODEL/APPLICATION	SAKURA NO	MODEL/APPLICATION	SAKURA NO	MODEL/APPLICATION	SAKURA NO
CATERPILLAR		CATERPILLAR		CATERPILLAR	
RTC60 (<i>FORKLIFTS</i>)		T30B-T60B (<i>FORKLIFTS</i>) CONTINEL F-163 GAS (S/N: 40N-UP)		T60C (<i>FORKLIFTS</i>) CAT 1404	
Hydraulic Oil Filter.....	HC-5501	Hydraulic Oil Filter.....	H-79411	Hydraulic Oil Filter.....	HC-5501
SF250 (<i>PAVING EQUIPMENT</i>) S/N: 6XC1-UP		T30B-T60B (<i>FORKLIFTS</i>) CONTINEL F-163 GAS (S/N: 42N-UP)		T60C-T120C (<i>FORKLIFTS</i>) CONTINEL F-227 (S/N: 18N-UP)	
Hydraulic Oil Filter.....	H-51170	Hydraulic Oil Filter.....	H-79411	Hydraulic Oil Filter.....	H-79411
SF550 (<i>PAVING EQUIPMENT</i>) S/N: 5PD1-UP		T30B-T60B (<i>FORKLIFTS</i>) CONTINEL F-163 GAS (S/N: 62R-UP)		T60C-T120C (<i>FORKLIFTS</i>) CONTINEL F-227 (S/N: 33L-UP)	
Hydraulic Oil Filter.....	H-51170	Hydraulic Oil Filter.....	H-79411	Hydraulic Oil Filter.....	H-79411
SS-250B (<i>PAVING EQUIPMENT</i>) CAT S/N: 11N13299-UP		T30B-T60B (<i>FORKLIFTS</i>) CONTINEL F-163 GAS (S/N: 64P-UP)		T60C-T120C (<i>FORKLIFTS</i>) CONTINEL F-227 (S/N: 35R-UP)	
Hydraulic Oil Filter.....	HC-5507	Hydraulic Oil Filter.....	H-79411	Hydraulic Oil Filter.....	H-79411
Hydraulic Oil Filter.....	HC-55220				
Hydraulic Oil Filter.....	H-5517				
SS-250B (<i>PAVING EQUIPMENT</i>) CAT S/N: 41Z1-UP		T30B-T60B (<i>FORKLIFTS</i>) PERKINS 3.152 DIESEL (S/N: 48S-UP)		T60C-T120C (<i>FORKLIFTS</i>) CONTINEL F-227 (S/N: 53R-UP)	
Hydraulic Oil Filter.....	HC-55220	Hydraulic Oil Filter.....	H-79411	Hydraulic Oil Filter.....	H-79411
Hydraulic Oil Filter.....	HC-5507				
Hydraulic Oil Filter.....	H-5517				
SS-250B (<i>PAVING EQUIPMENT</i>) CAT S/N: 5GR1-UP		T30C-TC60C (<i>FORKLIFTS</i>) CAT 1404 (S/N: 38Y-UP)		T60C-T120C (<i>FORKLIFTS</i>) CONTINEL F-227 GAS (S/N: 18N-UP)	
Hydraulic Oil Filter.....	HC-55220	Hydraulic Oil Filter.....	HC-5501	Hydraulic Oil Filter.....	H-79411
Hydraulic Oil Filter.....	HC-5507				
Hydraulic Oil Filter.....	H-5517				
SS-250B (<i>PAVING EQUIPMENT</i>) CAT S/N: 5GR1-UP		T30C-TC60C (<i>FORKLIFTS</i>) CAT 1404 (S/N: 93W-UP)		T60C-T120C (<i>FORKLIFTS</i>) CONTINEL F-227 GAS (S/N: 33L-UP)	
Hydraulic Oil Filter.....	H-5517	Hydraulic Oil Filter.....	H-79411	Hydraulic Oil Filter.....	H-79411
Hydraulic Oil Filter.....	HC-5507				
Hydraulic Oil Filter.....	HC-55220				
T100D-T150D (<i>FORKLIFTS</i>) PERKINS 4.236 GAS (S/N: 5MB-UP)		T30C-TC60C (<i>FORKLIFTS</i>) PERKINS 4.2032 (S/N: 66S-UP)		T60C-T120C (<i>FORKLIFTS</i>) CONTINEL F-227 GAS (S/N: 35R-UP)	
Hydraulic Oil Filter.....	HC-5501	Hydraulic Oil Filter.....	HC-5501	Hydraulic Oil Filter.....	H-79411
T100D-T150D (<i>FORKLIFTS</i>) PERKINS 4.2482 DIESEL (S/N: 5NB-UP)		T30-T60 (<i>FORKLIFTS</i>) CONTINEL F-163 (S/N: 07N-UP)		T60C-T120C (<i>FORKLIFTS</i>) CONTINEL F-227 GAS (S/N: 53R-UP)	
Hydraulic Oil Filter.....	HC-5501	Hydraulic Oil Filter.....	H-79411	Hydraulic Oil Filter.....	H-79411
T25D-TC40D (<i>FORKLIFTS</i>) PEUGEOT XN1P (S/N: 5GB-UP)		T30-T60 (<i>FORKLIFTS</i>) PERKINS 3.152 DIESEL (S/N: 95H-UP)		T60D-TC120D (<i>FORKLIFTS</i>) PERKINS 4.236 (S/N: 5KB-UP)	
Hydraulic Oil Filter.....	HC-5501	Hydraulic Oil Filter.....	H-79411	Hydraulic Oil Filter.....	HC-5501
T25D-TC40D (<i>FORKLIFTS</i>) PEUGEOT XN1P GAS (S/N: 5GB-UP)		T40D-TC60D (<i>FORKLIFTS</i>) PEUGEOT XD3P DIESEL (S/N: 2YB-UP)		T60D-TC120D (<i>FORKLIFTS</i>) PERKINS 4.236 (S/N: 5RB-UP)	
Hydraulic Oil Filter.....	HC-5501	Hydraulic Oil Filter.....	HC-5501	Hydraulic Oil Filter.....	H-79411
T25-TC30 (<i>FORKLIFTS</i>) CONTINEL F-163 (S/N: 11X-UP)		T40D-TC60D (<i>FORKLIFTS</i>) PEUGEOT XN1P (S/N: 8EB-UP)		T60D-TC120D (<i>FORKLIFTS</i>) PERKINS 4.236 GAS (S/N: 5KB-UP)	
Hydraulic Oil Filter.....	H-79411	Hydraulic Oil Filter.....	HC-5501	Hydraulic Oil Filter.....	HC-5501
T25-TC30 (<i>FORKLIFTS</i>) CONTINEL F-163 (S/N: 22Y-UP)		T40D-TC60D SA (<i>FORKLIFTS</i>) CAT 1404 (S/N: 2LC-UP)		T60D-TC120D (<i>FORKLIFTS</i>) PERKINS 4.236 GAS (S/N: 5RB-UP)	
Hydraulic Oil Filter.....	H-79411	Hydraulic Oil Filter.....	HC-5501	Hydraulic Oil Filter.....	H-79411
T25-TC30 (<i>FORKLIFTS</i>) CONTINEL F-163 (S/N: 71V-UP)		T40D-TC60D SA (<i>FORKLIFTS</i>) CAT 1404 (S/N: 9PB-UP)		T60D-TC120D (<i>FORKLIFTS</i>) PERKINS 4.2482 DIESEL (S/N: 5LB-UP)	
Hydraulic Oil Filter.....	HC-5501	Hydraulic Oil Filter.....	HC-5501	Hydraulic Oil Filter.....	HC-5501
T30B-T60B (<i>FORKLIFTS</i>) CAT 1404 (S/N: 13Y-UP)		T40D-TC60D SA (<i>FORKLIFTS</i>) CAT 1404 GAS (S/N: 2LC-UP)		T60D-TC120D (<i>FORKLIFTS</i>) PERKINS 4.2482 DIESEL (S/N: 5PB-UP)	
Hydraulic Oil Filter.....	H-79411	Hydraulic Oil Filter.....	HC-5501	Hydraulic Oil Filter.....	H-79411
T30B-T60B (<i>FORKLIFTS</i>) CAT 1404 (S/N: 16Y-UP)		T40D-TC60D SA (<i>FORKLIFTS</i>) CAT 1404 GAS (S/N: 9PB-UP)		TH103 (<i>HANDLER TELESCOPIC</i>) CAT 3054 (S/N: 3PN2500-UP)	
Hydraulic Oil Filter.....	H-79411	Hydraulic Oil Filter.....	HC-5501	Hydraulic Oil Filter.....	HC-5512
T30B-T60B (<i>FORKLIFTS</i>) CAT 1404 (S/N: 16Y-UP)		T40D-TC60D SA (<i>FORKLIFTS</i>) CAT 1404		TH220B (<i>HANDLER TELESCOPIC</i>) CAT 3054 (S/N: SLA1-UP)	
Hydraulic Oil Filter.....	H-79411	Hydraulic Oil Filter.....	HC-5501	Hydraulic Oil Filter.....	HC-5504



ENGINE APPLICATION

MODEL/APPLICATION	SAKURA NO	MODEL/APPLICATION	SAKURA NO	MODEL/APPLICATION	SAKURA NO
CATERPILLAR		CATERPILLAR		CATERPILLAR	
TH340B (HANDLER TELESCOPIC) CAT 3054 (S/N: SLC1-UP) , 2004-UP		Hydraulic Oil Filter.....	HC-5506	TK741 (FOREST EQUIPMENTS) S/N: 2021-224-UP	
Hydraulic Oil Filter.....	HC-5504	TH62 (HANDLER TELESCOPIC) S/N: 4TM1-UP		Hydraulic Oil Filter.....	H-5509
TH350B (HANDLER TELESCOPIC) S/N: SLD1-00531-UP		Hydraulic Oil Filter.....	HC-5506	Hydraulic Oil Filter.....	HC-5801
Hydraulic Oil Filter.....	HC-5504	Hydraulic Oil Filter.....	HC-5512	Hydraulic Oil Filter.....	HC-55170
TH355B (HANDLER TELESCOPIC) CATERPILLAR		TH63 (HANDLER TELESCOPIC) S/N: 5WM-06021-99999-UP		TK741 (FOREST EQUIPMENTS) S/N: 202225-UP	
Hydraulic Oil Filter.....	HC-5504	Hydraulic Oil Filter.....	HC-5512	Hydraulic Oil Filter.....	H-5509
TH355B (HANDLER TELESCOPIC) CAT S/N: CRX1-647-UP		TH82 (HANDLER TELESCOPIC) S/N: 3JN-01510-99999-UP		Hydraulic Oil Filter.....	HC-5801
Hydraulic Oil Filter.....	HC-5504	Hydraulic Oil Filter.....	HC-5512	Hydraulic Oil Filter.....	HC-55170
TH355B (HANDLER TELESCOPIC) CAT S/N: JRK1-UP		TH82 EN (HANDLER TELESCOPIC) S/N: 3KN1-UP		TK751 (FOREST EQUIPMENTS) S/N: 3011-324-UP	
Hydraulic Oil Filter.....	HC-5504	Hydraulic Oil Filter.....	HC-5506	Hydraulic Oil Filter.....	H-5509
TH360B (HANDLER TELESCOPIC) S/N: SLE1-01250-UP		Hydraulic Oil Filter.....	HC-5503	Hydraulic Oil Filter.....	HC-55170
Hydraulic Oil Filter.....	HC-5504	Hydraulic Oil Filter.....	HC-5506	Hydraulic Oil Filter.....	HC-5801
TH330B (HANDLER TELESCOPIC) CAT 3054 (S/N: SLB1-UP) , 2004-UP		TH82 EN (HANDLER TELESCOPIC) S/N: 3NN1-UP		TK751 (FOREST EQUIPMENTS) S/N: 301325-UP	
Hydraulic Oil Filter.....	HC-5504	Hydraulic Oil Filter.....	HC-5503	Hydraulic Oil Filter.....	HC-55170
TH460B (HANDLER TELESCOPIC) CAT C4.4 (S/N: SLF1-00791-UP)		Hydraulic Oil Filter.....	HC-5506	Hydraulic Oil Filter.....	H-5509
Hydraulic Oil Filter.....	HC-5504	TK1051 (FOREST EQUIPMENTS) CAT S/N: 3PD1-UP		Hydraulic Oil Filter.....	HC-5801
TH560B (HANDLER TELESCOPIC) S/N: SLG1-UP		Hydraulic Oil Filter.....	HC-5505	TK751 (FOREST EQUIPMENTS) S/N: 3021-424-UP	
Hydraulic Oil Filter.....	HC-5504	Hydraulic Oil Filter.....	HC-55170	Hydraulic Oil Filter.....	H-5509
TH580B (FORKLIFTS) CAT S/N: CRX107-647-UP , 2004-UP		Hydraulic Oil Filter.....	HC-5801	Hydraulic Oil Filter.....	HC-55170
Hydraulic Oil Filter.....	HC-5504	TK1051 (FOREST EQUIPMENTS) S/N: 9HZ1-UP		Hydraulic Oil Filter.....	HC-5801
TH580B (FORKLIFTS) CAT S/N: CRX1-106-UP , 2004-UP		Hydraulic Oil Filter.....	HC-5801	TK751 (FOREST EQUIPMENTS) S/N: 302425-UP	
Hydraulic Oil Filter.....	HC-5504	Hydraulic Oil Filter.....	HC-5505	Hydraulic Oil Filter.....	HC-55170
TH580B (FORKLIFTS) CAT S/N: CRX1-206-UP , 2004-UP		Hydraulic Oil Filter.....	HC-55170	Hydraulic Oil Filter.....	HC-5801
Hydraulic Oil Filter.....	HC-5504	TK370 (FOREST EQUIPMENTS) CAT 3126 (S/N: WBD1-UP)		Hydraulic Oil Filter.....	H-5509
TH580B (FORKLIFTS) CAT S/N: CRX1207-647-UP , 2004-UP		Hydraulic Oil Filter.....	HC-55300	V100F-VC110F (FORKLIFTS) PERKINS 4.236 (S/N: 6LG-UP)	
Hydraulic Oil Filter.....	HC-5504	TK371 (FOREST EQUIPMENTS) CAT S/N: 55K12201-UP		Hydraulic Oil Filter.....	HC-5501
TH580B (FORKLIFTS) CAT S/N: CRX1-647-UP , 2004-UP		Hydraulic Oil Filter.....	HC-5504	V100F-VC110F (FORKLIFTS) PERKINS 4.236 GAS (S/N: 6LG-UP)	
Hydraulic Oil Filter.....	HC-5504	Hydraulic Oil Filter.....	HC-55300	Hydraulic Oil Filter.....	HC-5501
TH580B (FORKLIFTS) CAT S/N: CRX648-UP , 2004-UP		TK371 (FOREST EQUIPMENTS) CAT S/N: WBG1-UP		V100F-VC110F (FORKLIFTS) PERKINS 4.2482 DIESEL (S/N: 1FK-UP)	
Hydraulic Oil Filter.....	HC-5504	Hydraulic Oil Filter.....	HC-5504	Hydraulic Oil Filter.....	HC-5501
TH580B (FORKLIFTS) CAT S/N: SLG1-UP , 2004-UP		Hydraulic Oil Filter.....	HC-55300	V100-V150 (FORKLIFTS) PERKINS 4.236 DIESEL (S/N: 60D-UP)	
Hydraulic Oil Filter.....	HC-5504	TK381 (FOREST EQUIPMENTS) CAT S/N: 55K12115-UP		Hydraulic Oil Filter.....	H-5640
TH580B (FORKLIFTS) CAT S/N: SLH1-UP , 2004-UP		Hydraulic Oil Filter.....	HC-5504	V100-V150 (FORKLIFTS) PERKINS 4.236 DIESEL (S/N: 8EF-UP)	
Hydraulic Oil Filter.....	HC-5504	Hydraulic Oil Filter.....	HC-55300	Hydraulic Oil Filter.....	HC-5501
TH62 (HANDLER TELESCOPIC) S/N: 3LN1-UP		TK381 (FOREST EQUIPMENTS) CAT S/N: WBH1-UP		Hydraulic Oil Filter.....	H-5517
Hydraulic Oil Filter.....	HC-5512	Hydraulic Oil Filter.....	HC-5504	V100-V150 (FORKLIFTS) PERKINS 4.236 GAS (S/N: 59W-UP)	
		Hydraulic Oil Filter.....	HC-5504	Hydraulic Oil Filter.....	H-5517
		TK711 (FOREST EQUIPMENTS) CAT C9 (S/N: 101-1-UP)		V100-V150 (FORKLIFTS) PERKINS 4.236 GAS (S/N: 60W-UP)	
		Hydraulic Oil Filter.....	H-5509	Hydraulic Oil Filter.....	HC-5501
		Hydraulic Oil Filter.....	HC-5801	Hydraulic Oil Filter.....	H-5517
		Hydraulic Oil Filter.....	HC-55170		



ENGINE APPLICATION

MODEL/APPLICATION	SAKURA NO	MODEL/APPLICATION	SAKURA NO	MODEL/APPLICATION	SAKURA NO
CATERPILLAR		CATERPILLAR		CATERPILLAR	
V100-V150 (<i>FORKLIFTS</i>) PERKINS 4.236 GAS (S/N: 60W-UP)		V30B-V60B (<i>FORKLIFTS</i>) CONTINEL F-163 (S/N: 81M00788-81M01316) Hydraulic Oil Filter..... H-79411		V30B-V60B (<i>FORKLIFTS</i>) CONTINEL F-227 (S/N: 89M00641-89M00942) Hydraulic Oil Filter..... H-79411	
V1100 CTH (<i>FORKLIFTS</i>) CAT 3208DSL (S/N: 6BF-UP) Hydraulic Oil Filter..... H-5504 Hydraulic Oil Filter..... H-5517		V30B-V60B (<i>FORKLIFTS</i>) CONTINEL F-163 (S/N: 81M01317-81M02459) Hydraulic Oil Filter..... H-79411		V30B-V60B (<i>FORKLIFTS</i>) CONTINEL F-227 (S/N: TO-36N00427) Hydraulic Oil Filter..... H-79411	
V110B-V155B (<i>FORKLIFTS</i>) PERKINS 4.236 DIESEL (S/N: 3WG-UP) Hydraulic Oil Filter..... H-5517		V30B-V60B (<i>FORKLIFTS</i>) CONTINEL F-163 (S/N: TO-32N00445) Hydraulic Oil Filter..... H-79411		V30B-V60B (<i>FORKLIFTS</i>) CONTINEL F-227 (S/N: TO-87M00736) Hydraulic Oil Filter..... H-79411	
V160B-V200B (<i>FORKLIFTS</i>) CAT 3208 (S/N: 67Y-UP) Hydraulic Oil Filter..... H-5517		V30B-V60B (<i>FORKLIFTS</i>) CONTINEL F-163 (S/N: TO-33N00531) Hydraulic Oil Filter..... H-79411		V30B-V60B (<i>FORKLIFTS</i>) CONTINEL F-227 GAS (S/N: 35N00474-UP) Hydraulic Oil Filter..... H-79411	
V160B-V200B (<i>FORKLIFTS</i>) CAT 3208 (S/N: 84Y-UP) Hydraulic Oil Filter..... H-5504		V30B-V60B (<i>FORKLIFTS</i>) CONTINEL F-163 (S/N: TO-36N00427) Hydraulic Oil Filter..... H-79411		V30B-V60B (<i>FORKLIFTS</i>) CONTINEL F-227 GAS (S/N: 36N00428-36N00473) Hydraulic Oil Filter..... H-79411	
V160B-V200B (<i>FORKLIFTS</i>) CAT 3208 (S/N: 9AF-UP) Hydraulic Oil Filter..... H-5517 Hydraulic Oil Filter..... H-5504		V30B-V60B (<i>FORKLIFTS</i>) CONTINEL F-163 (S/N: TO-79M00948) Hydraulic Oil Filter..... H-79411		V30B-V60B (<i>FORKLIFTS</i>) CONTINEL F-227 GAS (S/N: 37N00564-37N00662) Hydraulic Oil Filter..... H-79411	
V200B-V225B (<i>FORKLIFTS</i>) CAT 3208 (S/N: 69Y-UP) Hydraulic Oil Filter..... H-5517		V30B-V60B (<i>FORKLIFTS</i>) CONTINEL F-163 GAS (S/N: 32N00446-UP) Hydraulic Oil Filter..... H-79411		V30B-V60B (<i>FORKLIFTS</i>) CONTINEL F-227 GAS (S/N: 75P-75P) Hydraulic Oil Filter..... H-79411	
V200B-V225B (<i>FORKLIFTS</i>) CAT 3208 (S/N: 85Y-UP) Hydraulic Oil Filter..... H-5504		V30B-V60B (<i>FORKLIFTS</i>) CONTINEL F-163 GAS (S/N: 33N00532-UP) Hydraulic Oil Filter..... H-79411		V30B-V60B (<i>FORKLIFTS</i>) CONTINEL F-227 GAS (S/N: 87M00764-UP) Hydraulic Oil Filter..... H-79411	
V250B-V330B (<i>FORKLIFTS</i>) CAT 3208 (S/N: 71Y-UP) Hydraulic Oil Filter..... H-5517		V30B-V60B (<i>FORKLIFTS</i>) CONTINEL F-163 GAS (S/N: 54R-54R) Hydraulic Oil Filter..... H-79411		V30B-V60B (<i>FORKLIFTS</i>) CONTINEL F-227 GAS (S/N: 89M00943-89M01751) Hydraulic Oil Filter..... H-79411	
V250B-V330B (<i>FORKLIFTS</i>) CAT 3208 (S/N: 86Y-UP) Hydraulic Oil Filter..... H-5504 Hydraulic Oil Filter..... H-5517		V30B-V60B (<i>FORKLIFTS</i>) CONTINEL F-163 GAS (S/N: 79M00949-UP) Hydraulic Oil Filter..... H-79411		V30B-V60B (<i>FORKLIFTS</i>) PERKINS 4.236 DIESEL (S/N: 52J00616-UP) Hydraulic Oil Filter..... H-79411	
V25D-VC40D (<i>FORKLIFTS</i>) PEUGEOT XD3P DIESEL (S/N: 5JB-UP) Hydraulic Oil Filter..... HC-5501		V30B-V60B (<i>FORKLIFTS</i>) CONTINEL F-163 GAS (S/N: 81M00788-81M01316) Hydraulic Oil Filter..... H-79411		V30B-V60B (<i>FORKLIFTS</i>) PERKINS 4.236 DIESEL (S/N: 77P-77P) Hydraulic Oil Filter..... H-79411	
V25D-VC40D (<i>FORKLIFTS</i>) PEUGEOT XN1P (S/N: 5HB-UP) Hydraulic Oil Filter..... HC-5501		V30B-V60B (<i>FORKLIFTS</i>) CONTINEL F-163 GAS (S/N: 81M01317-81M02459) Hydraulic Oil Filter..... H-79411		V30B-V60B (<i>FORKLIFTS</i>) PERKINS 4.236 DIESEL (S/N: 83M00457-UP) Hydraulic Oil Filter..... H-79411	
V25D-VC40D (<i>FORKLIFTS</i>) PEUGEOT XN1P GAS (S/N: 5HB-UP) Hydraulic Oil Filter..... HC-5501		V30B-V60B (<i>FORKLIFTS</i>) CONTINEL F-163 GAS (S/N: TO-32N00445) Hydraulic Oil Filter..... H-79411		V30B-V60B (<i>FORKLIFTS</i>) PERKINS 4.236 DIESEL (S/N: TO-52J00615) Hydraulic Oil Filter..... H-79411	
V30B-V60B (<i>FORKLIFTS</i>) CONTINEL F-163 (S/N: 32N00446-UP) Hydraulic Oil Filter..... H-79411		V30B-V60B (<i>FORKLIFTS</i>) CONTINEL F-163 GAS (S/N: TO-33N00531) Hydraulic Oil Filter..... H-79411		V30B-V60B (<i>FORKLIFTS</i>) PERKINS 4.236 DIESEL (S/N: TO-83M00456) Hydraulic Oil Filter..... H-79411	
V30B-V60B (<i>FORKLIFTS</i>) CONTINEL F-163 (S/N: 33N00532-UP) Hydraulic Oil Filter..... H-79411		V30B-V60B (<i>FORKLIFTS</i>) CONTINEL F-163 GAS (S/N: TO-79M00948) Hydraulic Oil Filter..... H-79411		V30C-VC60C (<i>FORKLIFTS</i>) CAT 1404 GAS (S/N: 10U-UP) Hydraulic Oil Filter..... HC-5501	
V30B-V60B (<i>FORKLIFTS</i>) CONTINEL F-163 (S/N: 79M00949-UP) Hydraulic Oil Filter..... H-79411		V30B-V60B (<i>FORKLIFTS</i>) CONTINEL F-227 (S/N: 37N00462-37N00563) Hydraulic Oil Filter..... H-79411		V30C-VC60C (<i>FORKLIFTS</i>) CAT 1404 GAS (S/N: 75Y-UP) Hydraulic Oil Filter..... H-79411	
		V30B-V60B (<i>FORKLIFTS</i>) CONTINEL F-227 (S/N: 84M-84M) Hydraulic Oil Filter..... H-79411		V30C-VC60C (<i>FORKLIFTS</i>) CAT 1404 GAS (S/N: 96P-UP) Hydraulic Oil Filter..... H-79411	



ENGINE APPLICATION

MODEL/APPLICATION	SAKURA NO	MODEL/APPLICATION	SAKURA NO	MODEL/APPLICATION	SAKURA NO
CATERPILLAR		CATERPILLAR		CATERPILLAR	
V30C-VC60C (<i>FORKLIFTS</i>) CONTINEL F-227 (S/N: 77U-UP)	H-79411	Hydraulic Oil Filter.....	H-5517	Hydraulic Oil Filter.....	H-7942
V30C-VC60C (<i>FORKLIFTS</i>) CONTINEL F-227 GAS (S/N: 39U-UP)	HC-5501	V550-V620 (<i>FORKLIFTS</i>) CAT 3208 (S/N: 95C-UP)	H-5517	Hydraulic Oil Filter.....	HC-5801
V30C-VC60C (<i>FORKLIFTS</i>) CONTINEL F-227 GAS (S/N: 77U-UP)	H-79411	Hydraulic Oil Filter.....	H-5504	Hydraulic Oil Filter.....	H-5522
V30C-VC60C (<i>FORKLIFTS</i>) PERKINS 4.2032 DIESEL (S/N: 48Y-UP)	H-79411	V700-V800 (<i>FORKLIFTS</i>) CAT 3208DSL (S/N: 5LC-UP)	H-5517	Hydraulic Oil Filter.....	HC-5504
V30C-VC60C (<i>FORKLIFTS</i>) PERKINS 4.2032 DIESEL (S/N: 95W-UP)	HC-5501	Hydraulic Oil Filter.....	H-5504	W345C (<i>EXCAVATORS</i>) CAT S/N: MHX300-UP	H-5522
V30C-VC60C (<i>FORKLIFTS</i>) PERKINS 4.236 DIESEL (S/N: 43U-UP)	H-79411	V70F-V90F (<i>FORKLIFTS</i>) PERKINS 4.236 (S/N: 9NF-UP)	H-5517	Hydraulic Oil Filter.....	HC-5801
V30-V60 (<i>FORKLIFTS</i>) CONTINEL F-163 (S/N: 76M-UP)	H-79411	Hydraulic Oil Filter.....	H-5517	Hydraulic Oil Filter.....	HC-55170
V30-V60 (<i>FORKLIFTS</i>) PERKINS 3.152 DIESEL (S/N: 57W-UP)	H-79411	V70F-V90F (<i>FORKLIFTS</i>) PERKINS 4.2482 DIESEL (S/N: 2GJ-UP)	HC-5501	Hydraulic Oil Filter.....	H-7942
V40D THRU VC60D SA (<i>FORKLIFTS</i>) CAT 1404	HC-5501	Hydraulic Oil Filter.....	HC-5501	W345C (<i>EXCAVATORS</i>) CAT S/N: RSK1-UP	HC-5504
V40D THRU VC60D SA (<i>FORKLIFTS</i>) PERKINS 4.2032	HC-5501	V900 CH (<i>FORKLIFTS</i>) CAT 3208DSL (S/N: 3WD-UP)	H-5517	Hydraulic Oil Filter.....	H-7942
V40D-VC60D (<i>FORKLIFTS</i>) CAT 1404 (S/N: 95B-UP)	HC-5501	Hydraulic Oil Filter.....	H-5504	Hydraulic Oil Filter.....	HC-5801
V40D-VC60D (<i>FORKLIFTS</i>) CAT 1404 GAS (S/N: 95B-UP)	HC-5501	V925 (<i>FORKLIFTS</i>) CAT 3208DSL (S/N: 8FB-UP)	H-5517	Hydraulic Oil Filter.....	HC-5504
V40D-VC60D (<i>FORKLIFTS</i>) PERKINS 4.2032 DIESEL (S/N: 5BC-UP)	HC-5501	Hydraulic Oil Filter.....	H-5517	W345B II (<i>EXCAVATORS</i>) S/N: ANJ1-UP	H-7942
V40D-VC60D (<i>FORKLIFTS</i>) PEUGEOT XD3P DIESEL (S/N: 9RB-UP)	HC-5501	V925 LH (<i>FORKLIFTS</i>) CAT 3208DSL (S/N: 8NF-UP)	H-5517	Hydraulic Oil Filter.....	HC-5505
V40D-VC60D (<i>FORKLIFTS</i>) PEUGEOT XN1P (S/N: 3EC-UP)	HC-5501	Hydraulic Oil Filter.....	H-5504	Hydraulic Oil Filter.....	HC-55170
V40D-VC60D (<i>FORKLIFTS</i>) PEUGEOT XN1P GAS (S/N: 3EC-UP)	HC-5501	VC60C (<i>FORKLIFTS</i>)	HC-5501	Hydraulic Oil Filter.....	HC-5801
V550-V620 (<i>FORKLIFTS</i>) CAT 3208 (S/N: 2DD-UP)	H-5504	Hydraulic Oil Filter.....	HC-5501	W345B MH (<i>MATERIAL HANDLERS</i>) CAT 3176C (S/N: CDY1-UP)	H-7942
		VC60D SA (<i>FORKLIFTS</i>) CAT 1404	HC-5501	Hydraulic Oil Filter.....	HC-5801
		Hydraulic Oil Filter.....	HC-5501	Hydraulic Oil Filter.....	HC-5505
		VC60D SA (<i>FORKLIFTS</i>) PERKINS 4.2032	HC-5501	W345B II MH (<i>MATERIAL HANDLERS</i>) CAT 3176C (S/N: ANJ1-UP)	HC-5505
		Hydraulic Oil Filter.....	HC-5501	Hydraulic Oil Filter.....	HC-5801
		W330B (<i>MATERIAL HANDLERS</i>) CAT 3306 (S/N: AME1-UP)	HC-5801	Hydraulic Oil Filter.....	H-7942
		Hydraulic Oil Filter.....	H-7942	W345BII MH (<i>MATERIAL HANDLERS</i>) CAT 3176C (S/N: ANJ1-UP)	HC-5505
		Hydraulic Oil Filter.....	HC-5505	Hydraulic Oil Filter.....	HC-5801
		W330B MH (<i>MATERIAL HANDLERS</i>) CAT 3306 (S/N: AME1-UP)	H-7942	Hydraulic Oil Filter.....	H-7942
		Hydraulic Oil Filter.....	H-7942	CHALLENGER	
		Hydraulic Oil Filter.....	HC-5801	45 (<i>TRACTORS</i>) CAT 3116 ATAAC , 2002-UP	
		W345C (<i>EXCAVATORS</i>) CAT S/N: M3M1-UP	HC-55170	Hydraulic Oil Filter.....	HC-5504
		Hydraulic Oil Filter.....	HC-55170	Hydraulic Oil Filter.....	HC-5506
				55 (<i>TRACTORS</i>) CAT 3126 ATAAC , 2002-UP	
				Hydraulic Oil Filter.....	HC-5506
				Hydraulic Oil Filter.....	HC-5503
				Hydraulic Oil Filter.....	HC-5504
				65 (<i>TRACTORS</i>) CAT 3306	
				Hydraulic Oil Filter.....	HC-5508
				Hydraulic Oil Filter.....	HC-5506



ENGINE APPLICATION

MODEL/APPLICATION	SAKURA NO	MODEL/APPLICATION	SAKURA NO	MODEL/APPLICATION	SAKURA NO
CHALLENGER		CHEVROLET		CLAAS	
65 (TRACTORS) CAT 3306		KODIAK C6500 (LIGHT COMMERCIALS) ISUZU 7.8L DURAMAX		COMMANDOR 228CS (COMBINES) MERCEDES OM443	
Hydraulic Oil Filter.....	HC-5503	Hydraulic Oil Filter Transmission..	H-8537-S	Hydraulic Oil Filter.....	HC-55240
65C (TRACTORS) CAT 3306		Hydraulic Oil Filter Transmission....	H-8538	Hydraulic Oil Filter.....	HC-57020
Hydraulic Oil Filter.....	HC-5503	KODIAK C7500 (LIGHT COMMERCIALS) CAT C7		Commandor / Dominator CS-Serie (HARVESTERS) CO 114 CS DB OM 421	
Hydraulic Oil Filter.....	HC-5506	Hydraulic Oil Filter Transmission....	H-8538	Hydraulic Oil Filter.....	HC-62020
65E (TRACTORS) CAT 3176 CATAAC , 2002-UP		Hydraulic Oil Filter Transmission..	H-8537-S	Commandor / Dominator CS-Serie (HARVESTERS) CO 115 CS DB OM 421 A	
Hydraulic Oil Filter.....	HC-5503	KODIAK C7500 (LIGHT COMMERCIALS) CAT 3126E		Hydraulic Oil Filter.....	HC-62020
Hydraulic Oil Filter.....	HC-5506	Hydraulic Oil Filter.....	HC-69031	DOMINATOR 88 SL (COMBINES) PERKINS 1006.6 , 6600	
70C (TRACTORS) CAT 3306		KODIAK C7500 (LIGHT COMMERCIALS) GMC V8 496 8.1L VORTEC		Hydraulic Oil Filter.....	HC-55240
Hydraulic Oil Filter.....	HC-5506	Hydraulic Oil Filter Transmission..	H-8537-S	DOMINATOR 88 SL (COMBINES) CLAAS T6.354.4	
Hydraulic Oil Filter.....	HC-5503	Hydraulic Oil Filter Transmission....	H-8538	Hydraulic Oil Filter.....	HC-57020
75 (TRACTORS) CAT 3176		KODIAK C7500 (LIGHT COMMERCIALS) ISUZU 7.8L DURAMAX		DOMINATOR 88 SL (COMBINES) MERCEDES OM366A	
Hydraulic Oil Filter.....	HC-5503	Hydraulic Oil Filter Transmission....	H-8538	Hydraulic Oil Filter.....	HC-55240
Hydraulic Oil Filter.....	HC-5506	Hydraulic Oil Filter Transmission..	H-8537-S	Hydraulic Oil Filter.....	HC-57020
Hydraulic Oil Filter.....	HC-5508	KODIAK C8500 (LIGHT COMMERCIALS) CAT C7		DOMINATOR 88 SL (COMBINES) PERKINS 1006.6	
75C (TRACTORS) CAT 3176		Hydraulic Oil Filter Transmission....	H-8538	Hydraulic Oil Filter.....	HC-57020
Hydraulic Oil Filter.....	HC-5503	Hydraulic Oil Filter Transmission..	H-8537-S	DOMINATOR 88 SL (COMBINES) PERKINS T1006-6	
Hydraulic Oil Filter.....	HC-5506	KODIAK C8500 (LIGHT COMMERCIALS) GMC V8 496 8.1L VORTEC		Hydraulic Oil Filter.....	HC-57020
85C (TRACTORS) CAT 3176		Hydraulic Oil Filter Transmission....	H-8538	DOMINATOR 88 VX (COMBINES) PERKINS 1006-6T , 6600	
Hydraulic Oil Filter.....	HC-5503	Hydraulic Oil Filter Transmission..	H-8537-S	Hydraulic Oil Filter.....	HC-55240
Hydraulic Oil Filter.....	HC-5506	KODIAK C8500 (LIGHT COMMERCIALS) ISUZU 7.8L DURAMAX		DOMINATOR 88 VX (COMBINES) PERKINS 1006-60TW , 6600	
85D (TRACTORS) CAT 3196		Hydraulic Oil Filter Transmission..	H-8537-S	Hydraulic Oil Filter.....	HC-55240
Hydraulic Oil Filter.....	HC-5503	Hydraulic Oil Filter Transmission....	H-8538	DOMINATOR 88 VX (COMBINES) PERKINS 1006-60TW , 6600	
Hydraulic Oil Filter.....	HC-5506	KODIAK C8500 (LIGHT COMMERCIALS) ISUZU 7.8L DURAMAX		Hydraulic Oil Filter.....	HC-57020
85E (TRACTORS) CAT 3196 ATAAC , 2002-UP		Hydraulic Oil Filter Transmission..	H-8537-S	DOMINATOR 88 VX (COMBINES) MERCEDES OM352A	
Hydraulic Oil Filter.....	HC-5506	Hydraulic Oil Filter Transmission....	H-8538	Hydraulic Oil Filter.....	HC-57020
Hydraulic Oil Filter.....	HC-5503	CITROEN		DOMINATOR 98 (COMBINES) MERCEDES OM366A	
CHASESIDE ENGINEERING		CLAAS		Hydraulic Oil Filter.....	HC-55240
3000 AL (LOADERS) DORMAN		CC1400 (COMBINES)		Hydraulic Oil Filter.....	HC-57020
Hydraulic Oil Filter Transmission...	H-65030	Hydraulic Oil Filter.....	HC-6217	DOMINATOR 98 SL (COMBINES) MERCEDES OM366A	
3000 AL (LOADERS) LEYLAND 0.68		CHALLENGER 35 (TRACTORS) CAT 3116 ATAAC		Hydraulic Oil Filter.....	HC-55240
Hydraulic Oil Filter Transmission...	H-65030	Hydraulic Oil Filter.....	HC-5504	DOMINATOR 98 SL (COMBINES) MERCEDES OM366A	
CHEVROLET		CHALLENGER 45 (TRACTORS) CAT 3116 ATAAC		Hydraulic Oil Filter.....	HC-55240
KODIAK C6500 (LIGHT COMMERCIALS) CAT C7		Hydraulic Oil Filter.....	HC-5504	DOMINATOR 98 SL (COMBINES) MERCEDES OM366A	
Hydraulic Oil Filter Transmission..	H-8537-S	CHALLENGER 55 (TRACTORS) CAT 3126 ATAAC		Hydraulic Oil Filter.....	HC-55240
Hydraulic Oil Filter Transmission....	H-8538	Hydraulic Oil Filter.....	HC-5504	DOMINATOR 98 SL (COMBINES) MERCEDES OM352A	
KODIAK C6500 (LIGHT COMMERCIALS) GMC V8 496 8.1L VORTEC		CHALLENGER 95E (TRACTORS) CAT 3196 ATAAC		Hydraulic Oil Filter.....	HC-55240
Hydraulic Oil Filter Transmission..	H-8537-S	Hydraulic Oil Filter.....	HC-5503		
Hydraulic Oil Filter Transmission....	H-8538				



ENGINE APPLICATION

MODEL/APPLICATION	SAKURA NO	MODEL/APPLICATION	SAKURA NO	MODEL/APPLICATION	SAKURA NO
CLAAS		CLAAS		CLAAS	
DOMINATOR 98 SL (COMBINES) MERCEDES OM360 Hydraulic Oil Filter.....	HC-55240	Hydraulic Oil Filter.....	HC-55240	Hydraulic Oil Filter.....	HC-55240
DOMINATOR 98 VX (COMBINES) PERKINS 1006-60TW , 6600 Hydraulic Oil Filter.....	HC-55240	LEXION 460 (COMBINES) MERCEDES OM401LA Hydraulic Oil Filter.....	HC-55240	LEXION 440 (COMBINES) PERKINS 1306.9TA , 6900 Hydraulic Oil Filter.....	HC-55240
DOMINATOR 98 VX (COMBINES) MERCEDES OM366LA Hydraulic Oil Filter.....	HC-55240	LEXION 470 (COMBINES) CAT C9 , 2001-2003 Hydraulic Oil Filter.....	HC-57020	LEXION 440 (COMBINES) CAT 3126B , 2001-UP Hydraulic Oil Filter.....	HC-57020
DOMINATOR 98 VX (COMBINES) MERCEDES OM366LA Hydraulic Oil Filter.....	HC-57020	LEXION 470 (COMBINES) CAT C9 Hydraulic Oil Filter.....	HC-55240	LEXION 440 (COMBINES) PERKINS 1306.9TA5 , 1996-2001 Hydraulic Oil Filter.....	HC-57020
DOMINATOR 98 VX (COMBINES) PERKINS 1006-60TW Hydraulic Oil Filter.....	HC-57020	LEXION 480 (COMBINES) CAT C12 , 2001-2003 Hydraulic Oil Filter.....	HC-57020	LEXION 440 (COMBINES) CAT 3126B Hydraulic Oil Filter.....	HC-55240
DOMINATOR 98SL MAXI (COMBINES) MERCEDES OM366A Hydraulic Oil Filter.....	HC-57020	LEXION 480 (COMBINES) MERCEDES OM441LA , 1996-2001 Hydraulic Oil Filter.....	HC-57020	LEXION 440 (COMBINES) MERCEDES OM401LA Hydraulic Oil Filter.....	HC-55240
Dominator (6) (HARVESTERS) 106, 106 SL DB OM 401.901 Hydraulic Oil Filter.....	HC-62020	LEXION 480 (COMBINES) CAT C12 Hydraulic Oil Filter.....	HC-55240	LEXION 440 (COMBINES) PERKINS 1306-E87TA Hydraulic Oil Filter.....	HC-55240
Dominator (6) (HARVESTERS) 106, 106 SL DB OM 421 Hydraulic Oil Filter.....	HC-62020	LEXION 480 (COMBINES) MERCEDES OM441LA Hydraulic Oil Filter.....	HC-55240	LEXION 460 EVOLUTION (COMBINES) CAT C9 , 2001-2003 Hydraulic Oil Filter.....	HC-57020
Dominator (8) (HARVESTERS) 108 SL DB OM 421 Hydraulic Oil Filter.....	HC-62020	LEXION 410 (COMBINES) PERKINS 1006.6TA , 6600 Hydraulic Oil Filter.....	HC-55240	LEXION 460 EVOLUTION (COMBINES) CAT C9 Hydraulic Oil Filter.....	HC-55240
Dominator (8) (HARVESTERS) 118 SL DB OM 441A Hydraulic Oil Filter.....	HC-62020	LEXION 410 (COMBINES) PERKINS 1006.6TA , 1996-2001 Hydraulic Oil Filter.....	HC-57020	LEXION 415 (COMBINES) PERKINS 1006.6TA , 6600 Hydraulic Oil Filter.....	HC-55240
Dominator (8) (HARVESTERS) 98 SL DB OM 360 Hydraulic Oil Filter.....	HC-62020	LEXION 410 (COMBINES) CAT 3126B Hydraulic Oil Filter.....	HC-55240	LEXION 430 (COMBINES) CAT 3126B Hydraulic Oil Filter.....	HC-55240
Dominator VX (HARVESTERS) 98 SL DB OM 360 Hydraulic Oil Filter.....	HC-62020	LEXION 405 (COMBINES) PERKINS 1006.6TW , 6600 Hydraulic Oil Filter.....	HC-55240	LEXION 430 (COMBINES) MERCEDES OM366LA Hydraulic Oil Filter.....	HC-55240
LEXION 450 (COMBINES) CAT C9 , 2001-2003 Hydraulic Oil Filter.....	HC-57020	LEXION 405 (COMBINES) PERKINS 1006-60TW , 6600 Hydraulic Oil Filter.....	HC-55240	LEXION 460 MTS (COMBINES) CAT C9 Hydraulic Oil Filter.....	HC-55240
LEXION 450 (COMBINES) MERCEDES OM401LA , 1996-2001 Hydraulic Oil Filter.....	HC-57020	LEXION 420 (COMBINES) MERCEDES OM366LA , 1996-2001 Hydraulic Oil Filter.....	HC-57020	LEXION 480 MTS (COMBINES) CAT C12 Hydraulic Oil Filter.....	HC-55240
LEXION 450 (COMBINES) CAT C9 Hydraulic Oil Filter.....	HC-55240	LEXION 420 (COMBINES) CAT 3126B Hydraulic Oil Filter.....	HC-55240	MEGA 202 (COMBINES) MERCEDES OM366A Hydraulic Oil Filter.....	HC-57020
LEXION 450 (COMBINES) MERCEDES OM401LA Hydraulic Oil Filter.....	HC-55240	LEXION 420 (COMBINES) MERCEDES OM366LA Hydraulic Oil Filter.....	HC-55240	MEGA 202 (COMBINES) PERKINS T1006-6 Hydraulic Oil Filter.....	HC-57020
LEXION 460 (COMBINES) CAT C9 , 2001-2003 Hydraulic Oil Filter.....	HC-57020	LEXION 430 EVOLUTION (COMBINES) CAT 3126B , 2001-UP Hydraulic Oil Filter.....	HC-57020	MEGA 204 (COMBINES) MERCEDES OM366LA Hydraulic Oil Filter.....	HC-57020
LEXION 460 (COMBINES) CAT C9 Hydraulic Oil Filter.....	HC-57020	LEXION 430 EVOLUTION (COMBINES) CAT 3126B Hydraulic Oil Filter.....	HC-57020	MEGA II 204 (COMBINES) MERCEDES OM366LA Hydraulic Oil Filter.....	HC-57020



ENGINE APPLICATION

MODEL/APPLICATION	SAKURA NO	MODEL/APPLICATION	SAKURA NO	MODEL/APPLICATION	SAKURA NO
CLAAS		CLARK		CLARK	
MEGA II 204 (COMBINES) MERCEDES OM366LA Hydraulic Oil Filter.....	HC-57020	125A SERIES I (BACKHOE LOADERS) DETROITD 4-71 Hydraulic Oil Filter Transmission...	H-65030	210 SERIES I (SCRAPERS) DETROITD 8V-71 Hydraulic Oil Filter Transmission...	H-65030
MEGA II 350 (COMBINES) MERCEDES OM906LA , 2003-UP Hydraulic Oil Filter.....	HC-62020	125A SERIES I (BACKHOE LOADERS) Hydraulic Oil Filter Transmission...	H-65030	210 SERIES III & HANCOCK (SCRAPERS) DETROITD 8V-71N Hydraulic Oil Filter Transmission...	H-65030
MEGA 218 II (COMBINES) MERCEDES OM441A Hydraulic Oil Filter.....	HC-55240	125A SERIES II (BACKHOE LOADERS) CUMMINS Hydraulic Oil Filter Transmission...	H-65030	210 SERIES IIIH (SCRAPERS) Hydraulic Oil Filter Transmission...	H-65030
RANGER 911 T (LOADERS) PERKINS 4.236T , 1993-1997 Hydraulic Oil Filter.....	HC-7913	125A SERIES II (BACKHOE LOADERS) DETROITD 6V-53 Hydraulic Oil Filter Transmission...	H-65030	222 (SCRAPERS) Hydraulic Oil Filter.....	H-5405
TUCANO 440 (COMBINES) MERCEDES OM906LA , 2007-UP Hydraulic Oil Filter.....	HC-62020	175A SERIES I (BACKHOE LOADERS) CUMMINS TURBO Hydraulic Oil Filter Transmission...	H-65030	275A SERIES I (BACKHOE LOADERS) CUMMINS Hydraulic Oil Filter Transmission...	H-65030
TUCANO 450 (COMBINES) MERCEDES OM926LA , 2007-UP Hydraulic Oil Filter.....	HC-62020	175A SERIES I (BACKHOE LOADERS) DETROITD 4-71 Hydraulic Oil Filter Transmission...	H-65030	275A SERIES I (BACKHOE LOADERS) DETROITD 8V-71 Hydraulic Oil Filter Transmission...	H-65030
CLARK		175A SERIES I (BACKHOE LOADERS) DETROITD 6V-53 Hydraulic Oil Filter Transmission...	H-65030	275A SERIES II (BACKHOE LOADERS) CUMMINS Hydraulic Oil Filter Transmission...	H-65030
110 SERIES III (SCRAPERS) CUMMINS C-175 Hydraulic Oil Filter Transmission...	H-65030	175A SERIES I (BACKHOE LOADERS) WAUKESHA 135DKB DIESEL Hydraulic Oil Filter Transmission...	H-65030	275A SERIES II (BACKHOE LOADERS) DETROITD 8V-71N Hydraulic Oil Filter Transmission...	H-65030
110 SERIES III (SCRAPERS) DETROITD 6V-53 Hydraulic Oil Filter Transmission...	H-65030	175A SERIES I (BACKHOE LOADERS) WAUKESHA 135GKB GAS Hydraulic Oil Filter Transmission...	H-65030	275C (BACKHOE LOADERS) CUMMINS KT-1150 Hydraulic Oil Filter.....	HC-5503
110-11 (SCRAPERS) DETROIT DIESEL Hydraulic Oil Filter.....	H-5405	175A SERIES II (BACKHOE LOADERS) CUMMINS Hydraulic Oil Filter Transmission...	H-65030	275C (LOADERS) w/Cummins KT1150C Eng. Hydraulic Oil Filter.....	HC-55250
Hydraulic Oil Filter.....	H-51170	175A SERIES III (BACKHOE LOADERS) CUMMINS Hydraulic Oil Filter Transmission...	H-65030	280 SERIES I (DOZERS) CUMMINS Hydraulic Oil Filter Transmission...	H-65030
110-11B (SCRAPERS) Hydraulic Oil Filter.....	H-51170	175A SERIES III (BACKHOE LOADERS) DETROITD 6V-71N Hydraulic Oil Filter Transmission...	H-65030	280 SERIES I (DOZERS) DETROITD 8V-71 Hydraulic Oil Filter Transmission...	H-65030
110-12 SERIES III-H (SCRAPERS) DETROITD 6V-53 Hydraulic Oil Filter Transmission...	H-65030	180 SERIES I (DOZERS) CUMMINS Hydraulic Oil Filter Transmission...	H-65030	280 SERIES III (DOZERS) CUMMINS Hydraulic Oil Filter Transmission...	H-65030
110-15 (SCRAPERS) Hydraulic Oil Filter.....	H-51170	180 SERIES I (DOZERS) DETROITD 6V-53 Hydraulic Oil Filter Transmission...	H-65030	280C (DOZERS) Hydraulic Oil Filter.....	HC-5503
110-9B (SCRAPERS) Hydraulic Oil Filter.....	H-51170	180 SERIES III (DOZERS) CUMMINS Hydraulic Oil Filter Transmission...	H-65030	292C (SCRAPERS) Hydraulic Oil Filter.....	H-51170
Hydraulic Oil Filter Transmission....	H-5109	180 SERIES III (DOZERS) DETROITD 6V-53 Hydraulic Oil Filter Transmission...	H-65030	Hydraulic Oil Filter.....	H-5405
110H-T (SCRAPERS) Hydraulic Oil Filter.....	H-51170	210 SERIES I (SCRAPERS) CUMMINS Hydraulic Oil Filter Transmission...	H-65030	292B 292 & 292B (SCRAPERS)	
110HTB (SCRAPERS) Hydraulic Oil Filter.....	H-51170				
11E4 (SCRAPERS) Hydraulic Oil Filter.....	H-5405				



ENGINE APPLICATION

MODEL/APPLICATION	SAKURA NO	MODEL/APPLICATION	SAKURA NO	MODEL/APPLICATION	SAKURA NO
CLARK		CLARK		CLARK	
292B 292 & 292B (SCRAPERS)		Hydraulic Oil Filter.....	HC-5503	Hydraulic Oil Filter Transmission...	H-65030
Hydraulic Oil Filter.....	H-5405	475C (BACKHOE LOADERS) CUMMINS VT-1710		75 SERIES II (BACKHOE LOADERS) WAUKESHA F283G	
292E (SCRAPERS)		Hydraulic Oil Filter.....	HC-5503	Hydraulic Oil Filter Transmission...	H-65030
Hydraulic Oil Filter.....	H-51170	475C (LOADERS) w/Cummins 1710 Eng.		85 SERIES II (BACKHOE LOADERS) CUMMINS	
294 (SCRAPERS)		Hydraulic Oil Filter.....	HC-55250	Hydraulic Oil Filter Transmission...	H-65030
Hydraulic Oil Filter.....	H-5405	480TD (DOZERS) CUMMINS		85 SERIES II (BACKHOE LOADERS) DETROITD 4-53	
Hydraulic Oil Filter.....	H-51170	Hydraulic Oil Filter Transmission...	H-65030	Hydraulic Oil Filter Transmission...	H-65030
35C (BACKHOE LOADERS) DETROITD 472A		480TD (DOZERS) DETROITD 16V-71		85 SERIES II (BACKHOE LOADERS) WAUKESHA 1356Z DIESEL	
Hydraulic Oil Filter.....	HC-5503	Hydraulic Oil Filter Transmission...	H-65030	Hydraulic Oil Filter Transmission...	H-65030
Hydraulic Oil Filter.....	HC-7913	55AWS (BACKHOE LOADERS) PERKINS 6.354		85 SERIES IIIA (BACKHOE LOADERS) GMC	
35C (BACKHOE LOADERS) PERKINS 458A		Hydraulic Oil Filter Transmission...	H-65030	Hydraulic Oil Filter Transmission...	H-65030
Hydraulic Oil Filter.....	HC-5503	55C (BACKHOE LOADERS) CUMMINS V-378		BL60 (BACKHOE LOADERS) CONTINEL F-244 GAS	
Hydraulic Oil Filter.....	HC-7913	Hydraulic Oil Filter.....	HC-5503	Hydraulic Oil Filter.....	H-7983
375 SERIES (BACKHOE LOADERS) CUMMINS		55C (BACKHOE LOADERS) DETROITD 4-53N		Hydraulic Oil Filter.....	H-5405
Hydraulic Oil Filter Transmission...	H-65030	Hydraulic Oil Filter.....	HC-5503	BL700 (BACKHOE LOADERS) CLARK F224-388	
375A (BACKHOE LOADERS) CUMMINS		55C (LOADERS) w/Cummins V378C Eng.		Hydraulic Oil Filter.....	H-51170
Hydraulic Oil Filter Transmission...	H-65030	Hydraulic Oil Filter.....	HC-55250	BL700 (BACKHOE LOADERS) CONTINEL CONTINENTAL GAS	
380B (DOZERS) CUMMINS VT-1710		55 SERIES II (BACKHOE LOADERS) CONTINEL CONTINENTAL GAS		Hydraulic Oil Filter.....	H-51170
Hydraulic Oil Filter.....	HC-5503	Hydraulic Oil Filter Transmission...	H-65030	BL700 (BACKHOE LOADERS) DETROITD 3-53	
380B (DOZERS) DETROITD 16V-71N		55 SERIES II (BACKHOE LOADERS) DETROITD 3-53		Hydraulic Oil Filter.....	H-51170
Hydraulic Oil Filter.....	HC-5503	Hydraulic Oil Filter Transmission...	H-65030	CLARK DCS-251 (FORKLIFTS)	
380 SERIES II (DOZERS) CUMMINS		65R (BACKHOE LOADERS) PERKINS T6.354		Hydraulic Oil Filter.....	HC-7913
Hydraulic Oil Filter Transmission...	H-65030	Hydraulic Oil Filter Transmission...	H-65030	Hydraulic Oil Filter.....	HC-7941
380 SERIES II (DOZERS) DETROITD 12V-71		667D (SKIDDERS) DETROITD 4-53		DCS251 (FORKLIFTS)	
Hydraulic Oil Filter Transmission...	H-65030	Hydraulic Oil Filter.....	H-7983	Hydraulic Oil Filter.....	HC-7913
380B Dozer (SHOVELS) w/Cummins VT1710 Eng.		667 (SKIDDERS) DETROITD 4-53		Hydraulic Oil Filter.....	HC-7941
Hydraulic Oil Filter.....	HC-55250	Hydraulic Oil Filter.....	H-7983	GCS20-30/MB (FORKLIFTS) MITSUBISI 4G54 (S/N: 5520-6831)	
392 (SCRAPERS)		667FWD (SKIDDERS) DETROITD 4-53		Hydraulic Oil Filter.....	HC-7913
Hydraulic Oil Filter.....	H-51170	Hydraulic Oil Filter.....	H-7983	Hydraulic Oil Filter.....	HC-7941
45C (BACKHOE LOADERS) DETROITD 3-53T		667GR (SKIDDERS) DETROITD 4-53		GCS20-30/MB (FORKLIFTS) MITSUBISI 4G54 (S/N: 5536-6835)	
Hydraulic Oil Filter.....	HC-5503	Hydraulic Oil Filter.....	H-7983	Hydraulic Oil Filter.....	HC-7941
45C (BACKHOE LOADERS) DETROITD 473A		75 SERIES II (BACKHOE LOADERS) DETROITD 4-53		Hydraulic Oil Filter.....	HC-7913
Hydraulic Oil Filter.....	HC-7913	Hydraulic Oil Filter Transmission...	H-65030	GCS20-30/MC (FORKLIFTS) MITSUBISI 4G54 (S/N: 5516-6820)	
Hydraulic Oil Filter.....	HC-5503	75 SERIES II (BACKHOE LOADERS) WAUKESHA F283 GAS		Hydraulic Oil Filter.....	HC-7913
45C (BACKHOE LOADERS) PERKINS 459A				GCS20-30/MC (FORKLIFTS) MITSUBISI 4G54 (S/N: 5531-6320)	
Hydraulic Oil Filter.....	HC-7913			Hydraulic Oil Filter.....	HC-7913



ENGINE APPLICATION

MODEL/APPLICATION	SAKURA NO	MODEL/APPLICATION	SAKURA NO	MODEL/APPLICATION	SAKURA NO
CLARK		CLARK		CLEVELAND	
GCS20-30/MC (FORKLIFTS) MITSUBISI 4G54 (S/N: 5531-6320)		RANGER 664 (SKIDDERS) DETROITD 3-53		740A (GRADERS) CUMMINS LT10	
Hydraulic Oil Filter.....	HC-7941	Hydraulic Oil Filter.....	H-7983	Hydraulic Oil Filter.....	HC-5503
GCS20-30/WC (FORKLIFTS) WAUKESHA D176 (S/N: 5510-6086)		RANGER 666 (SKIDDERS) CUMMINS C-352		760 (GRADERS)	
Hydraulic Oil Filter.....	HC-7941	Hydraulic Oil Filter.....	H-7983	Hydraulic Oil Filter Transmission....	H-65030
Hydraulic Oil Filter.....	HC-7913				
GPS20-30/WC (FORKLIFTS) WAUKESHA D176 (S/N: 5526-6091)		RANGER 666 (SKIDDERS) DETROITD 4-53		780 (GRADERS) CUMMINS LT10	
Hydraulic Oil Filter.....	HC-7941	Hydraulic Oil Filter.....	H-7983	Hydraulic Oil Filter.....	HC-5503
IT-50BP (FORKLIFTS) PERKINS		RANGER 667 (SKIDDERS) CUMMINS		780A (GRADERS) CUMMINS LT10	
Hydraulic Oil Filter.....	H-5405	Hydraulic Oil Filter.....	H-7983	Hydraulic Oil Filter.....	HC-5503
L190 (SHOVELS) w/Cummins Eng.		RANGER 668 (SKIDDERS) CUMMINS V-504		D-160 (TRENCHERS) ALLISCHA 282	
Hydraulic Oil Filter.....	HC-55250	Hydraulic Oil Filter.....	H-7983	Hydraulic Oil Filter Transmission....	H-65030
L190 LOADING SHOVELO (BACKHOE LOADERS) CUMMINS		RANGER 668 (SKIDDERS) DETROITD 6V-53		CMC	
Hydraulic Oil Filter.....	HC-5503	Hydraulic Oil Filter.....	H-7983	5800 (EQUIPMENT) 2008-UP	
L190B (BACKHOE LOADERS) CUMMINS		RANGER 664 GR (SKIDDERS) DETROITD 3-53		Hydraulic Oil Filter.....	H-7602
Hydraulic Oil Filter.....	HC-5503	Hydraulic Oil Filter.....	H-7983	COMPAIR	
L270 (BACKHOE LOADERS)		RANGER 666GR (SKIDDERS) DETROITD 4-53		175 (CONSTRUCTION & MINING) DEUTZ F3L912	
Hydraulic Oil Filter.....	HC-5503	Hydraulic Oil Filter.....	H-7983	Hydraulic Oil Filter.....	HC-7905
L270B (BACKHOE LOADERS)		W380 (DOZERS) CUMMINS		6010 (CONSTRUCTION & MINING)	
Hydraulic Oil Filter.....	HC-5503	Hydraulic Oil Filter.....	HC-5503	Hydraulic Oil Filter.....	HC-7905
L320 (BACKHOE LOADERS)		CLEVELAND		C110-9 (AIR COMPRESSORS) DEUTZ BF4M2012EC	
Hydraulic Oil Filter.....	HC-5503	710 (GRADERS) CUMMINS 6BT5.9		Hydraulic Oil Filter.....	HC-5502
PACER & SUPER 100 & 200 (GRADERS) CUMMINS		Hydraulic Oil Filter.....	HC-5503	C190TS-10 (AIR COMPRESSORS) CUMMINS 6BTTAA5.9 , 2001-UP	
Hydraulic Oil Filter.....	HC-1903	710A (GRADERS) CUMMINS 6BT5.9		Hydraulic Oil Filter.....	HC-5502
PACER & SUPER 100 & 200 (GRADERS) DETROITD 3-71		Hydraulic Oil Filter.....	HC-5503	C200TS-10 (AIR COMPRESSORS) CUMMINS 6BTTAA5.9 , 2001-UP	
Hydraulic Oil Filter.....	HC-1903	720 (GRADERS) CUMMINS 6CT8.3		Hydraulic Oil Filter.....	HC-5502
PACER & SUPER 300 (GRADERS) CUMMINS		Hydraulic Oil Filter.....	HC-5503	C210TS-9 (AIR COMPRESSORS)	
Hydraulic Oil Filter.....	H-7936	720A (GRADERS) CUMMINS 6CT8.3		Hydraulic Oil Filter.....	HC-5502
Hydraulic Oil Filter.....	HC-1903	Hydraulic Oil Filter.....	HC-5503	C220TS-10 (AIR COMPRESSORS) CUMMINS 6BTTAA5.9 , 2001-UP	
PACER & SUPER 300 (GRADERS) DETROITD 4-71		730 (GRADERS) CUMMINS 6CT8.3		Hydraulic Oil Filter.....	HC-5502
Hydraulic Oil Filter.....	H-7936	Hydraulic Oil Filter.....	HC-5503	C50 DLT 0407 (AIR COMPRESSORS) CUMMINS (S/N: 10692494-UP) , 2008-UP	
Hydraulic Oil Filter.....	HC-1903	730A (GRADERS) CUMMINS 6CT8.3		Hydraulic Oil Filter.....	HC-6802
PACER & SUPER 400 & 500 (GRADERS) GMC 4-71		Hydraulic Oil Filter.....	HC-5503	C55-14 (AIR COMPRESSORS) DEUTZ BF4M2011	
Hydraulic Oil Filter.....	HC-1903	740 (GRADERS) CUMMINS LT10		Hydraulic Oil Filter.....	HC-6802
RANGER 662 (SKIDDERS)		Hydraulic Oil Filter.....	HC-5503	Z190S (AIR COMPRESSORS)	
Hydraulic Oil Filter.....	H-7983			Hydraulic Oil Filter.....	HC-6802



ENGINE APPLICATION

MODEL/APPLICATION	SAKURA NO	MODEL/APPLICATION	SAKURA NO	MODEL/APPLICATION	SAKURA NO
COMPAIR		DAEWOO		DAEWOO	
ZITAIR 250 (AIR COMPRESSORS) DEUTZ F4L912		DH200LC (EXCAVATORS) RENAULTV D0846 HM		Hydraulic Oil Filter.....	H-2704
Hydraulic Oil Filter.....	HC-1822	Hydraulic Oil Filter.....	H-2704	MEGA 400-3 (LOADERS)	
Hydraulic Oil Filter.....	HC-6802			Hydraulic Oil Filter.....	H-7911
CUMMINS		DH200W (EXCAVATORS) DAEWOO D1146		Hydraulic Oil Filter.....	HC-6802
(ENGINES) CUMMINS MTA11		Hydraulic Oil Filter.....	H-2704	MEGA 400V (LOADERS) DAEWOO DE12T	
Hydraulic Oil Filter.....	H-5618	DH210W/V (EXCAVATORS)		Hydraulic Oil Filter.....	H-7911
Hydraulic Oil Filter.....	H-5609	Hydraulic Oil Filter.....	H-2704	MEGA 250 (LOADERS)	
CURBMASTER		DH220ED (EXCAVATORS)		Hydraulic Oil Filter Transmission...	HC-76130
MARK I (TRACTORS) DEUTZ		Hydraulic Oil Filter.....	H-2704	MEGA 400-III (LOADERS) DAEWOO D2366T	
Hydraulic Oil Filter.....	HC-62010	DH220LC (EXCAVATORS)		Hydraulic Oil Filter.....	HC-5503
CURTISS-WRIGHT		Hydraulic Oil Filter.....	H-2704	MK111 S 220 (LOADERS)	
CW-220 (SCRAPERS) DETROIT 6-110		DH280 (EXCAVATORS) DAEWOO D2366		Hydraulic Oil Filter.....	H-2704
Hydraulic Oil Filter Transmission...	H-65030	Hydraulic Oil Filter.....	H-2704	S220LC-III (EXCAVATORS)	
CW-226 (SCRAPERS) DETROIT 6-110		DH280ED (EXCAVATORS)		Hydraulic Oil Filter.....	H-2704
Hydraulic Oil Filter Transmission...	H-65030	Hydraulic Oil Filter.....	H-2704	S330-III (EXCAVATORS)	
CWD-221 (SCRAPERS) DETROIT 6-110		DH220 (EXCAVATORS)		Hydraulic Oil Filter.....	H-7911
Hydraulic Oil Filter Transmission...	H-65030	Hydraulic Oil Filter.....	H-2704	S400LC-III (EXCAVATORS)	
DAEWOO		DH320 (EXCAVATORS) DAEWOO D2366		Hydraulic Oil Filter.....	H-7911
170 5 SERIES (CONSTRUCTION & MINING)		Hydraulic Oil Filter.....	H-2704	S450-III (EXCAVATORS)	
170 5 SERIES		DH450 (EXCAVATORS) DAEWOO D2848T		Hydraulic Oil Filter.....	H-7911
Hydraulic Oil Filter.....	H-4101	Hydraulic Oil Filter.....	H-2704	SOLAR 130V (EXCAVATORS)	
Hydraulic Oil Filter.....	H-7923	Hydraulic Oil Filter.....	H-7911	Hydraulic Oil Filter.....	H-2704
170 5 SERIES (LOADERS)		DX300LC (EXCAVATORS) DOOSAN DL08 , 2005-UP		SOLAR 130W (EXCAVATORS)	
Hydraulic Oil Filter.....	H-7911	Hydraulic Oil Filter.....	H-2719	Hydraulic Oil Filter.....	H-2704
DH130 (EXCAVATORS) ISUZU 6BB1		M400 (LOADERS)		SOLAR 130W-III (EXCAVATORS) DAEWOO DB58T	
Hydraulic Oil Filter.....	H-2704	Hydraulic Oil Filter.....	H-2704	Hydraulic Oil Filter.....	H-2704
DH130-2 (EXCAVATORS) DAEWOO DB58		MEGA 200 (LOADERS) DAEWOO DB58T , 2004-UP		SOLAR 170-III (EXCAVATORS) DAEWOO DB58T	
Hydraulic Oil Filter.....	H-2704	Hydraulic Oil Filter.....	H-2704	Hydraulic Oil Filter.....	H-7911
DH130-II (EXCAVATORS)		MEGA 200-III (LOADERS)		Hydraulic Oil Filter.....	H-2719
Hydraulic Oil Filter.....	H-2704	Hydraulic Oil Filter.....	H-2704	Hydraulic Oil Filter.....	H-2704
DH130W (EXCAVATORS)		MEGA 300 (LOADERS) DAEWOO D2366T , 2004-UP		SOLAR 170LCV (EXCAVATORS) DAEWOO DB58T	
Hydraulic Oil Filter.....	H-2704	Hydraulic Oil Filter.....	H-2704	Hydraulic Oil Filter.....	H-7911
DH170 (EXCAVATORS) PERKINS 1006-6 6HR		MEGA 300 (LOADERS)		SOLAR 170W-III (EXCAVATORS) DAEWOO D1146N	
Hydraulic Oil Filter.....	H-2704	Hydraulic Oil Filter.....	H-2704	Hydraulic Oil Filter.....	H-2704
DH180LC (EXCAVATORS) RENAULTV D0846 HM		MEGA 400 (LOADERS)		SOLAR 170WV (EXCAVATORS) DAEWOO DB58TI	
Hydraulic Oil Filter.....	H-2704	Hydraulic Oil Filter.....	H-2704	Hydraulic Oil Filter.....	H-7911



ENGINE APPLICATION

MODEL/APPLICATION	SAKURA NO	MODEL/APPLICATION	SAKURA NO	MODEL/APPLICATION	SAKURA NO
DAEWOO		DAF		DAVIS	
SOLAR 170WV (EXCAVATORS) DAEWOO DB58TI		85CF (TRUCKS) DAF XF.M TYPE , 2000-UP Hydraulic Oil Filter Transmission.... H-7102		12+4 (CONSTRUCTION & MINING) WISCONSIN V-461 Hydraulic Oil Filter..... HC-7932 Hydraulic Oil Filter..... HC-7932	
SOLAR 200W-III (EXCAVATORS) DAEWOO D1146 Hydraulic Oil Filter..... H-2704		85CF.480 (TRUCKS) DAF XE355C - EURO 3 , 2002-UP Hydraulic Oil Filter Transmission.... H-7102		40+4 (CONSTRUCTION & MINING) WISCONSIN WISCONSIN Hydraulic Oil Filter..... HC-7932	
SOLAR 200WV (EXCAVATORS) DAEWOO DB58TI Hydraulic Oil Filter..... H-7911		95XF (TRUCKS) DAF XF TYPE , TO-2002 Hydraulic Oil Filter Transmission.... H-7102		40+4 (TRENCHERS) WISCONSIN Hydraulic Oil Filter..... HC-7932	
SOLAR 220III (EXCAVATORS) Hydraulic Oil Filter..... H-2704		95XF (TRUCKS) DAF XE-C EURO 3 , 1999-2002 Hydraulic Oil Filter Transmission.... H-7102		70+4 (CONSTRUCTION & MINING) FORD 201 Hydraulic Oil Filter..... HC-7932 Hydraulic Oil Filter..... HC-7932	
SOLAR 220LCIII (EXCAVATORS) DAEWOO D1146 Hydraulic Oil Filter..... H-2704		95XF 380 (TRUCKS) DAF XE355C , 1999-2002 Hydraulic Oil Filter Transmission.... H-7102		800 (CONSTRUCTION & MINING) WISCONSIN V-465D Hydraulic Oil Filter..... HC-7932 Hydraulic Oil Filter..... HC-7932	
SOLAR 220V (EXCAVATORS) Hydraulic Oil Filter..... H-2704		CF75 (TRUCKS) DAF PE SERIES , 2001-UP Hydraulic Oil Filter Transmission.... H-7102		MINI-SNEAKER (TRENCHERS) ONAN Hydraulic Oil Filter..... HC-7932	
SOLAR 280LC-III (EXCAVATORS) DAEWOO D2366 Hydraulic Oil Filter..... H-7911		CF85 (TRUCKS) DAF XE TYPE , 2001-UP Hydraulic Oil Filter Transmission.... H-7102		ROAD RUNNER (TRENCHERS) CASE 188D Hydraulic Oil Filter..... HC-7932	
SOLAR 290LCV (EXCAVATORS) DAEWOO D1146TI Hydraulic Oil Filter..... H-2709		CF85 340 (TRUCKS) DAF XE250C (S/N: EURO 3-UP) , 2001-UP Hydraulic Oil Filter Transmission.... H-7102		SCATBACK (TRENCHERS) WISCONSIN VH-4D Hydraulic Oil Filter..... HC-7932	
SOLAR 290LL (EXCAVATORS) DAEWOO D1146T Hydraulic Oil Filter..... H-2704		CF85 340 (TRUCKS) DAF XE250E (S/N: EURO 3-UP) , 2001-UP Hydraulic Oil Filter Transmission.... H-7102		DEMAG	
SOLAR 300LCV (EXCAVATORS) DAEWOO , 2005-UP Hydraulic Oil Filter..... H-2709 Hydraulic Oil Filter..... H-2719		CF85 430 (TRUCKS) DAF XE315C (S/N: EURO 3-UP) , 2001-UP Hydraulic Oil Filter Transmission.... H-7102		140DS (AIR COMPRESSORS) KHD BF6L913C Hydraulic Oil Filter..... HC-5502	
SOLAR 340LCV (EXCAVATORS) DAEWOO DE12TIS (S/N: 1041-UP) , 2002-UP Hydraulic Oil Filter..... H-2719		CF85 480 (TRUCKS) DAF XE315E (S/N: EURO 3-UP) , 2001-UP Hydraulic Oil Filter Transmission.... H-7102		141DS (AIR COMPRESSORS) KHD F6L413F Hydraulic Oil Filter..... HC-5502	
SOLAR 70 III (EXCAVATORS) Hydraulic Oil Filter..... H-2704		CF85 480 (TRUCKS) DAF XE355C (S/N: EURO 3-UP) , 2002-UP Hydraulic Oil Filter Transmission.... H-7102		142DS (AIR COMPRESSORS) KHD BF6L913C Hydraulic Oil Filter..... HC-5502	
SOLAR LC320 (EXCAVATORS) DAEWOO D1146TI Hydraulic Oil Filter..... H-2704		CF85 480 (TRUCKS) DAF XE355E (S/N: EURO 3-UP) , 2002-UP Hydraulic Oil Filter Transmission.... H-7102		170DS (AIR COMPRESSORS) KHD BF6L913C Hydraulic Oil Filter..... HC-5502	
SOLAR 400LC-V (EXCAVATORS) DAEWOO DE12 Hydraulic Oil Filter..... H-2719		F75 (TRUCKS) DAF RS SERIES Hydraulic Oil Filter Transmission.... H-7102		171DS (AIR COMPRESSORS) KHD BF6L913C Hydraulic Oil Filter..... HC-5502	
DAF		F85 (TRUCKS) DAF WS SERIES Hydraulic Oil Filter Transmission.... H-7102		172DS (AIR COMPRESSORS) KHD BF6L913C Hydraulic Oil Filter..... HC-5502	
75CF (TRUCKS) DAF PF-M 9.2L Hydraulic Oil Filter Transmission.... H-7102		F95 (TRUCKS) DAF WS TYPE Hydraulic Oil Filter Transmission.... H-7102		174DS (AIR COMPRESSORS) KHD BF6L913C Hydraulic Oil Filter..... HC-5502	
75CF 250 (TRUCKS) DAF PF100M SERIES (S/N: EURO 2/3-UP) , 1998-2000 Hydraulic Oil Filter Transmission.... H-7102		XF105 460 (TRUCKS) PACCAR MX340S (S/N: EURO 4-UP) , 2006-UP Hydraulic Oil Filter Transmission.... H-7102		230DS (AIR COMPRESSORS) KHD F8L513	



ENGINE APPLICATION

MODEL/APPLICATION	SAKURA NO	MODEL/APPLICATION	SAKURA NO	MODEL/APPLICATION	SAKURA NO
DEMAG		DEMAG		DEMAG	
230DS (AIR COMPRESSORS) KHD F8L513 Hydraulic Oil Filter.....	HC-5502	JOCKEY 012 (AIR COMPRESSORS) S/N: 7.4 / 8.0 M3-UP Hydraulic Oil Filter.....	HC-6802	SC17DS (AIR COMPRESSORS) DEUTZ F6L413 Hydraulic Oil Filter.....	HC-6217
231DS (AIR COMPRESSORS) KHD F8L513 Hydraulic Oil Filter.....	HC-5502	JOCKEY 20 (AIR COMPRESSORS) S/N: TO-16M3 Hydraulic Oil Filter.....	HC-5502	SC 101 D (AIR COMPRESSORS) DEUTZ F6L912 Hydraulic Oil Filter.....	HC-5502
AC150 30T (CRANES) S/N: 36024-UP Hydraulic Oil Filter Transmission...	HC-2701	MARATHON 220 UP TO 222 (AIR COMPRESSORS) Hydraulic Oil Filter.....	HC-5502	SC 140 DS (AIR COMPRESSORS) DEUTZ BF6L913 Hydraulic Oil Filter.....	HC-5502
AC155 (CRANES) MERCEDES OM401LA , 1996-UP Hydraulic Oil Filter Transmission...	HC-2701	MARATHON 250 UP TO 302 (AIR COMPRESSORS) Hydraulic Oil Filter.....	HC-5502	SC 170 DS (AIR COMPRESSORS) DEUTZ BF6L913C Hydraulic Oil Filter.....	HC-5502
AC50-1 (CRANES) MERCEDES OM926LA , 2000-UP Hydraulic Oil Filter Transmission..	HC-76130	MARATHON 350 UP TO 422 (AIR COMPRESSORS) Hydraulic Oil Filter.....	HC-5502	SC20DS (AIR COMPRESSORS) DEUTZ F2L208F , 1990-UP Hydraulic Oil Filter.....	HC-6801
DF12C (PAVING EQUIPMENT) DEUTZ F3L912 Hydraulic Oil Filter.....	HC-7906	RALLYE 70 UP TO 112 (AIR COMPRESSORS) Hydraulic Oil Filter.....	HC-5502	SC20DS2 (AIR COMPRESSORS) DEUTZ F2L208F , 1990-UP Hydraulic Oil Filter.....	HC-6801
DF12C (PAVING EQUIPMENT) DEUTZ F4L912 Hydraulic Oil Filter.....	HC-7906	RALLYE 70 UP TO 112 (AIR COMPRESSORS) S/N: 446-UP Hydraulic Oil Filter.....	HC-5502	SC23D (AIR COMPRESSORS) DEUTZ F8L413 Hydraulic Oil Filter.....	HC-5502
DS100 (AIR COMPRESSORS) MERCEDES OM364A , 1994-UP Hydraulic Oil Filter.....	HC-6802	REGATA 140 UP TO 200 (AIR COMPRESSORS) Hydraulic Oil Filter.....	HC-5502	SC 20 DS-1 (AIR COMPRESSORS) DEUTZ Hydraulic Oil Filter.....	HC-6801
DS101 (AIR COMPRESSORS) MERCEDES OM364A , 1994-UP Hydraulic Oil Filter.....	HC-6802	SC10 (AIR COMPRESSORS) DEUTZ F6L912 Hydraulic Oil Filter.....	HC-6802	SC 20 DS-3 (AIR COMPRESSORS) DEUTZ F2L208F , 1995-UP Hydraulic Oil Filter.....	HC-6801
DS130 (AIR COMPRESSORS) MERCEDES OM366A , 1994-UP Hydraulic Oil Filter.....	HC-5502	SC10 (AIR COMPRESSORS) Hydraulic Oil Filter.....	HC-6217	SC3 (AIR COMPRESSORS) DEUTZ F2L912 Hydraulic Oil Filter.....	HC-6802
DS131 (AIR COMPRESSORS) MERCEDES OM366A , 1994-UP Hydraulic Oil Filter.....	HC-5502	SC100D (AIR COMPRESSORS) Hydraulic Oil Filter.....	HC-5502	SC30ES (AIR COMPRESSORS) Hydraulic Oil Filter.....	HC-6217
DS70 (AIR COMPRESSORS) KHD BF4L1011 , 1994-UP Hydraulic Oil Filter.....	HC-6802	SC100DW (AIR COMPRESSORS) PERKINS 6.354.4 Hydraulic Oil Filter.....	HC-5502	SC30ES-1 (AIR COMPRESSORS) Hydraulic Oil Filter.....	HC-6217
DS72 (AIR COMPRESSORS) KHD BF4L1011 , 1994-UP Hydraulic Oil Filter.....	HC-6802	SC10D (AIR COMPRESSORS) DEUTZ F6L912 Hydraulic Oil Filter.....	HC-5502	SC38DS (AIR COMPRESSORS) DEUTZ F2L912 Hydraulic Oil Filter.....	HC-6802
DS74 (AIR COMPRESSORS) KHD BF4L1011 , 1994-UP Hydraulic Oil Filter.....	HC-6802	SC10DS (AIR COMPRESSORS) DEUTZ BF6L912 Hydraulic Oil Filter.....	HC-6802	SC3DS (AIR COMPRESSORS) DEUTZ F2L912 Hydraulic Oil Filter.....	HC-6802
H285 (EXCAVATORS) CUMMINS KTTA3067 Hydraulic Oil Filter.....	H-62110	SC10ES (AIR COMPRESSORS) Hydraulic Oil Filter.....	HC-5502	SC3ES (AIR COMPRESSORS) Hydraulic Oil Filter.....	HC-6802
H65 (EXCAVATORS) Hydraulic Oil Filter.....	HC-5502	SC121D (AIR COMPRESSORS) DEUTZ F6L413 Hydraulic Oil Filter.....	HC-5502	SC40DS (AIR COMPRESSORS) DEUTZ Hydraulic Oil Filter.....	HC-6802
JOCKEY 012 (AIR COMPRESSORS) S/N: 5.2 / 6.1 M3-UP Hydraulic Oil Filter.....	HC-6802	SC14 (AIR COMPRESSORS) DEUTZ F6L413 Hydraulic Oil Filter.....	HC-6802	SC40DS1 (AIR COMPRESSORS) DEUTZ F2L511D	



ENGINE APPLICATION

MODEL/APPLICATION	SAKURA NO	MODEL/APPLICATION	SAKURA NO	MODEL/APPLICATION	SAKURA NO
DEMAG		DEMAG		DEMAG	
SC40DS1 (AIR COMPRESSORS) DEUTZ F2L511D Hydraulic Oil Filter.....	HC-6802	SE10S (AIR COMPRESSORS) Hydraulic Oil Filter.....	HC-6802	SE 61 S (AIR COMPRESSORS) Hydraulic Oil Filter.....	HC-5502
SC40ES (AIR COMPRESSORS) Hydraulic Oil Filter.....	HC-6217	SE16 (AIR COMPRESSORS) Hydraulic Oil Filter.....	HC-5502	SE 71 S (AIR COMPRESSORS) Hydraulic Oil Filter.....	HC-5502
SC40ES1 (AIR COMPRESSORS) Hydraulic Oil Filter.....	HC-6217	SE 111 S (AIR COMPRESSORS) Hydraulic Oil Filter.....	HC-5502	SE80 (AIR COMPRESSORS) Hydraulic Oil Filter.....	HC-6802
SC5 (AIR COMPRESSORS) DEUTZ F3L912 Hydraulic Oil Filter.....	HC-6802	SE 116 S UP TO 155 S (AIR COMPRESSORS) Hydraulic Oil Filter.....	HC-5502	SIRIUS 132 UP TO 160 (AIR COMPRESSORS) Hydraulic Oil Filter.....	HC-5502
SC50D (AIR COMPRESSORS) DEUTZ F3L912 Hydraulic Oil Filter.....	HC-6802	SE 116 S UP TO 155 S NORMAL TYPE (AIR COMPRESSORS) Hydraulic Oil Filter.....	HC-5502	SIRIUS 200 UP TO 250 (AIR COMPRESSORS) Hydraulic Oil Filter.....	HC-5502
SC50DS (AIR COMPRESSORS) DEUTZ Hydraulic Oil Filter.....	HC-6802	SE 116 S UP TO 155 S OLD TYPE (AIR COMPRESSORS) Hydraulic Oil Filter.....	HC-5502	SPRINT 2 025 UP TO 047 (AIR COMPRESSORS) Hydraulic Oil Filter.....	HC-6802
SC50DS (AIR COMPRESSORS) DEUTZ F3L912 Hydraulic Oil Filter.....	HC-6802	SE 12 (AIR COMPRESSORS) Hydraulic Oil Filter.....	HC-5502	SPRINT 3 050 UP TO 057 (AIR COMPRESSORS) Hydraulic Oil Filter.....	HC-6802
SC50DS1 (AIR COMPRESSORS) DEUTZ F4L1011 , 1990-UP Hydraulic Oil Filter.....	HC-6802	SE 180AS/WS UP TO 255AS/WS (AIR COMPRESSORS) Hydraulic Oil Filter.....	HC-5502	SZ350WES UP TO 353WES (AIR COMPRESSORS) Hydraulic Oil Filter.....	HC-5502
SC50DS1 (AIR COMPRESSORS) DEUTZ F3L912 Hydraulic Oil Filter.....	HC-6802	SE 191 WS UP TO 221 WS (AIR COMPRESSORS) Hydraulic Oil Filter.....	HC-5502	SZ400 HORIZONTAL TANK (AIR COMPRESSORS) Hydraulic Oil Filter.....	HC-5502
SC50DS2B (AIR COMPRESSORS) DEUTZ F4L1011 Hydraulic Oil Filter.....	HC-6802	SE20 (AIR COMPRESSORS) Hydraulic Oil Filter.....	HC-6802	SZ400 VERTICAL TANK (AIR COMPRESSORS) Hydraulic Oil Filter.....	HC-5502
SC5DS (AIR COMPRESSORS) DEUTZ F3L912 Hydraulic Oil Filter.....	HC-6802	SE26S (AIR COMPRESSORS) Hydraulic Oil Filter.....	HC-6802	DENNIS	
SC5ES (AIR COMPRESSORS) Hydraulic Oil Filter.....	HC-6802	SE 20 EKS (AIR COMPRESSORS) Hydraulic Oil Filter.....	HC-6802	Dart (BUSES) CUMMINS 6BTA5.9 Hydraulic Oil Filter.....	
SC 50 DT-1 (AIR COMPRESSORS) Hydraulic Oil Filter.....	HC-6802	SE30 (AIR COMPRESSORS) Hydraulic Oil Filter.....	HC-6802	DEUTZ-FAHR	
SC7 (AIR COMPRESSORS) DEUTZ F4L912 Hydraulic Oil Filter.....	HC-6802	SE 31 S UP TO 40 S (AIR COMPRESSORS) Hydraulic Oil Filter.....	HC-6802	5670 H (COMBINES) DEUTZ BF6L913 , 1999-UP Hydraulic Oil Filter.....	
SC70D (AIR COMPRESSORS) DEUTZ F4L912 Hydraulic Oil Filter.....	HC-6802	SE 350 WES (AIR COMPRESSORS) Hydraulic Oil Filter.....	HC-5502	5690 HTS (COMBINES) DEUTZ BF6M1013C , 1999-UP Hydraulic Oil Filter.....	
SC70DW (AIR COMPRESSORS) PERKINS 4.236 Hydraulic Oil Filter.....	HC-6802	SE41S (AIR COMPRESSORS) Hydraulic Oil Filter.....	HC-6802	AGROPLUS 80 (TRACTORS) DEUTZ F4L913 , 2001-UP Hydraulic Oil Filter.....	
SC7DS (AIR COMPRESSORS) DEUTZ F4L912 Hydraulic Oil Filter.....	HC-5502	SE50 (AIR COMPRESSORS) Hydraulic Oil Filter.....	HC-6802	DX3.10 V (TRACTORS) DEUTZ F4L913 , 1986-UP Hydraulic Oil Filter.....	
				DX4.56 A (TRACTORS) DEUTZ BF4L913 , 1991-UP Hydraulic Oil Filter.....	



ENGINE APPLICATION

MODEL/APPLICATION	SAKURA NO	MODEL/APPLICATION	SAKURA NO	MODEL/APPLICATION	SAKURA NO
DEUTZ - FAHR		DITCH WITCH		DOOSAN	
DX4.61 (TRACTORS)		JT4020 (DRILLING) JDEERE 6068TF , 2004-UP		DX360 (EXCAVATORS)	
Hydraulic Oil Filter.....	HC-1822	Hydraulic Oil Filter.....	HC-57020	Hydraulic Oil Filter.....	H-89060
M1600H (COMBINES) DEUTZ F8L413		JT420 (DRILLING) JDEERE 6068 POWERTECH		Hydraulic Oil Filter Pilot.....	H-89070
Hydraulic Oil Filter.....	HC-6801	Hydraulic Oil Filter.....	HC-55290	DX340LC (EXCAVATORS) DOOSAN DL08 , 2006-UP	
M600 (TRACTORS) DEUTZ F3L912		Hydraulic Oil Filter.....	HC-57020	Hydraulic Oil Filter.....	H-2719
Hydraulic Oil Filter.....	HC-1822	R100 (TRENCHERS) DITCHWIT DIESEL		DX300-3 (EXCAVATORS)	
M750 (TRACTORS) DEUTZ F3L912		Hydraulic Oil Filter.....	HC-5511	Hydraulic Oil Filter Pilot.....	H-89070
Hydraulic Oil Filter.....	HC-1822	R 30 (TRENCHERS) WISCONSIN VH-4D		Hydraulic Oil Filter.....	H-89060
SFH3008 (EQUIPMENT) DEUTZ F8L413F		Hydraulic Oil Filter.....	HC-19040	DX420LC (EXCAVATORS) DOOSAN DV11 , 2006-UP	
Hydraulic Oil Filter.....	HC-62020	R60 (TRENCHERS) DITCHWIT 60 HORSEPOWER		Hydraulic Oil Filter.....	H-2719
SFH4010 (EQUIPMENT) DEUTZ F10L413F		Hydraulic Oil Filter.....	HC-19040	SOLAR 160WV (EXCAVATORS) DAEWOO DB58TIS , 2006-UP	
Hydraulic Oil Filter.....	HC-62020	R65 (TRENCHERS) FORD 4-192		Hydraulic Oil Filter.....	H-2704
DEUTZ AG		Hydraulic Oil Filter.....	HC-19040	Hydraulic Oil Filter.....	H-7911
(ENGINES) DEUTZ F4L913		R65 (TRENCHERS) WISCONSIN V-465D		Hydraulic Oil Filter.....	H-2719
Hydraulic Oil Filter.....	HC-1822	Hydraulic Oil Filter.....	HC-19040	SOLAR 175LCV (EXCAVATORS) DAEWOO DB58TIS	
(ENGINES) DEUTZ F3L912		VP-12 (TRENCHERS) ONAN NH-MS		Hydraulic Oil Filter.....	H-7911
Hydraulic Oil Filter.....	HC-1822	Hydraulic Oil Filter.....	HC-19040	SOLAR 75V (EXCAVATORS) YANMAR 4TNE98	
(ENGINES) DEUTZ F4L912		DOOSAN		Hydraulic Oil Filter.....	H-2704
Hydraulic Oil Filter.....	HC-1822	DD80 (TRACTORS) DOOSAN DB85		DRESSER	
DIAMOND REO		Hydraulic Oil Filter.....	HC-55240	165 (LOADERS) IHC D310	
(ENGINES) DIAMOND SOME MODELS WITH		DX140 (EXCAVATORS)		Hydraulic Oil Filter Transmission...	H-65030
Hydraulic Oil Filter Power steering..	H-71160	Hydraulic Oil Filter.....	H-89060	175B (LOADERS) IHC D361	
DIAMOND T		Hydraulic Oil Filter Pilot.....	H-89070	Hydraulic Oil Filter.....	H-5405
(ENGINES) DIAMOND SOME MODELS WITH		DX210W (EXCAVATORS) DOOSAN DL06 , 2007-UP		175B (LOADERS) IHC DT407	
Hydraulic Oil Filter Power steering..	H-71160	Hydraulic Oil Filter.....	H-2719	Hydraulic Oil Filter.....	H-5405
DITCH WITCH		DX255LC (EXCAVATORS) DOOSAN DL06 , 2007-UP		175B (LOADERS) IHC UD-407	
2300 (CONSTRUCTION & MINING) WISCONSIN VH-4D		Hydraulic Oil Filter.....	H-2719	Hydraulic Oil Filter.....	H-5405
Hydraulic Oil Filter.....	HC-7932	DX255LCV (EXCAVATORS) 2006-UP		175C (LOADERS) INTERNL DT466	
Hydraulic Oil Filter.....	HC-7932	Hydraulic Oil Filter.....	H-2719	Hydraulic Oil Filter.....	H-5405
HT100 (TRENCHERS) JDEERE 4045T		DX210 (EXCAVATORS)		Hydraulic Oil Filter.....	H-5406
Hydraulic Oil Filter.....	HC-19040	Hydraulic Oil Filter Pilot.....	H-89070	250B (LOADERS) IHC DT429	
J20 (TRENCHERS) WISCONSIN TJD		Hydraulic Oil Filter.....	H-89060	Hydraulic Oil Filter.....	H-5405
Hydraulic Oil Filter.....	HC-19040	DX350 (EXCAVATORS)		250C (LOADERS) IHC DVT-573B	
JT2720 (DRILLING) JDEERE 4045TF , 2004-UP		Hydraulic Oil Filter Pilot.....	H-89070	Hydraulic Oil Filter.....	H-5403
Hydraulic Oil Filter.....	HC-57020	Hydraulic Oil Filter.....	H-89060	Hydraulic Oil Filter.....	H-5406



ENGINE APPLICATION

MODEL/APPLICATION	SAKURA NO	MODEL/APPLICATION	SAKURA NO	MODEL/APPLICATION	SAKURA NO
DRESSER		DRESSER		DRESSER	
250E (LOADERS) CUMMINS LTA10		970 (DOZERS)		TD20B (DOZERS)	
Hydraulic Oil Filter.....	H-5405	Hydraulic Oil Filter.....	H-5403	Hydraulic Oil Filter.....	H-5405
Hydraulic Oil Filter.....	H-5406				
Hydraulic Oil Filter.....	H-5403	A450E (GRADERS) DRESSER D359T		TD20C (DOZERS) IHC DVT-573B	
		Hydraulic Oil Filter.....	HC-69030	Hydraulic Oil Filter.....	H-5405
510 (LOADERS) KOMATSU 4D92		A500E (GRADERS) CUMMINS D505T		Hydraulic Oil Filter.....	H-5406
Hydraulic Oil Filter.....	H-5618	Hydraulic Oil Filter.....	HC-69030		
		A566E (GRADERS) IHC D505T		TD20E (DOZERS) IHC DVT-800	
510C (LOADERS) IHC D240T		Hydraulic Oil Filter.....	HC-69030	Hydraulic Oil Filter.....	H-5406
Hydraulic Oil Filter.....	H-5403			Hydraulic Oil Filter.....	H-5403
Hydraulic Oil Filter.....	HC-5402	SP780 (INDUSTRIAL EQUIPMENTS, ENGINES) DETROITD 6V-92TA		TD20E (DOZERS) IHC V-800	
		Hydraulic Oil Filter Transmission...	H-65030	Hydraulic Oil Filter.....	H-5406
515B (LOADERS)		TD12 (DOZERS) IHC D466		Hydraulic Oil Filter.....	H-5403
Hydraulic Oil Filter.....	HC-5402	Hydraulic Oil Filter.....	H-5403		
Hydraulic Oil Filter.....	H-5403	TD12C (DOZERS)		TD20G (DOZERS) CUMMINS	
		Hydraulic Oil Filter.....	H-5403	Hydraulic Oil Filter.....	H-5403
515C (LOADERS) IHC D358		TD15B (DOZERS) IHC DT466		TD25B (DOZERS) IHC DT817	
Hydraulic Oil Filter.....	H-5403	Hydraulic Oil Filter.....	H-5405	Hydraulic Oil Filter Transmission...	H-65030
Hydraulic Oil Filter.....	HC-5402	Hydraulic Oil Filter.....	H-5406		
		TD15B (DOZERS) IHC DT361		TD25C (DOZERS) IHC DT817B	
518B (LOADERS)		Hydraulic Oil Filter.....	H-5405	Hydraulic Oil Filter Transmission...	H-65030
Hydraulic Oil Filter.....	H-5618	Hydraulic Oil Filter.....	H-5406	Hydraulic Oil Filter.....	H-5403
Hydraulic Oil Filter.....	H-5607	TD15B (DOZERS) IHC DT407		Hydraulic Oil Filter.....	H-5406
		Hydraulic Oil Filter.....	H-5406	Hydraulic Oil Filter.....	H-5406
520B (LOADERS) IHC D359T		Hydraulic Oil Filter.....	H-5406	TD25C (DOZERS) IHC DT817C	
Hydraulic Oil Filter.....	H-5403	Hydraulic Oil Filter.....	H-5406	Hydraulic Oil Filter Transmission...	H-65030
		TD15C (DOZERS) IHC DT407		Hydraulic Oil Filter.....	H-5403
530 (LOADERS) IHC		Hydraulic Oil Filter.....	H-5406	Hydraulic Oil Filter.....	H-5406
Hydraulic Oil Filter.....	H-5403	Hydraulic Oil Filter.....	H-5406		
		TD15C (DOZERS) IHC DT466		TD25E (DOZERS) IHC DT817C	
530 (LOADERS) KOMATSU S6D105		Hydraulic Oil Filter.....	H-5406	Hydraulic Oil Filter Transmission...	H-65030
Hydraulic Oil Filter.....	H-5618	Hydraulic Oil Filter.....	H-5406	Hydraulic Oil Filter.....	H-5403
		TD15C (DOZERS) IHC DT407		Hydraulic Oil Filter.....	H-5406
540 (LOADERS) IHC		Hydraulic Oil Filter.....	H-5406		
Hydraulic Oil Filter.....	H-5403	Hydraulic Oil Filter.....	H-5406	TD25G (DOZERS) CUMMINS KT-1150	
		TD15C (DOZERS) INTERNTL DT466		Hydraulic Oil Filter.....	H-5403
540 (LOADERS) KOMATSU SA6D110-1		Hydraulic Oil Filter.....	H-5403	TD30 (DOZERS)	
Hydraulic Oil Filter.....	H-5618	Hydraulic Oil Filter.....	H-5406	Hydraulic Oil Filter Transmission...	H-65030
		Hydraulic Oil Filter.....	H-5406		
550 (LOADERS) CUMMINS NTA-855		TD15E (DOZERS) INTERNTL DT466C		TD40 (DOZERS) CUMMINS KTA-1150	
Hydraulic Oil Filter.....	H-5403	Hydraulic Oil Filter.....	H-5403	Hydraulic Oil Filter.....	H-5403
		TD15E (DOZERS) INTERNTL DT466E		TD40C (DOZERS)	
550 (LOADERS) IHC DVT-800		Hydraulic Oil Filter.....	H-5403	Hydraulic Oil Filter.....	H-5403
Hydraulic Oil Filter.....	H-5403	TD20B (DOZERS) IHC DT429		Hydraulic Oil Filter.....	HC-76080
		Hydraulic Oil Filter.....	H-5405		
570 (LOADERS)				TD8G (DOZERS) IHC D240T	
Hydraulic Oil Filter.....	H-5403			Hydraulic Oil Filter.....	H-5403
580 (LOADERS)					
Hydraulic Oil Filter Transmission...	H-65030				
Hydraulic Oil Filter.....	H-5403				



ENGINE APPLICATION

MODEL/APPLICATION	SAKURA NO	MODEL/APPLICATION	SAKURA NO	MODEL/APPLICATION	SAKURA NO
DRESSER		DROTT		DROTT	
TD9B (DOZERS) IHC D282		Hydraulic Oil Filter Transmission...	H-65030	35EC (CRANES) CASE	
Hydraulic Oil Filter Transmission...	H-65030	Hydraulic Oil Filter.....	H-79411	Hydraulic Oil Filter.....	H-79411
TD9B (DOZERS) IHC DT282		160CK CRAWLER (CRANES) DEUTZ		35EC (CRANES) DROTT DETROIT	
Hydraulic Oil Filter Transmission...	H-65030	Hydraulic Oil Filter.....	H-71140	Hydraulic Oil Filter.....	H-79411
VOS84A (COMPACTORS) GMC		Hydraulic Oil Filter.....	H-85110	35EC SERIES A CRAWLER (EXCAVATORS) GMC 4-53N	
Hydraulic Oil Filter.....	HC-69030	170B CRAWLER (CRANES) DEUTZ		Hydraulic Oil Filter.....	H-79411
VOSA84A (COMPACTORS)		Hydraulic Oil Filter.....	H-85110	35EC SERIES A CRAWLER (EXCAVATORS) GMC 3-53N	
Hydraulic Oil Filter.....	HC-69030	170C (CRANES) DEUTZ		Hydraulic Oil Filter.....	H-79411
VOSD84A (COMPACTORS)		Hydraulic Oil Filter.....	H-85110	35EC SERIES B CRAWLER (EXCAVATORS) GMC	
Hydraulic Oil Filter Transmission...	H-65030	200RF2 (CRANES) GMC 4-53		Hydraulic Oil Filter.....	H-79411
VOSPD84A (COMPACTORS)		Hydraulic Oil Filter Transmission...	H-65030	40 (CRANES) GMC 4-71	
Hydraulic Oil Filter Transmission...	H-65030	220B (EXCAVATORS) DEUTZ F10L413		Hydraulic Oil Filter Transmission...	H-65030
DRIL TECH		Hydraulic Oil Filter.....	H-71140	40 (CRANES) GMC 4-53N	
D25K (DRILLING) CATERPILLAR		300 CRAWLER (EXCAVATORS) DEUTZ F12L413		Hydraulic Oil Filter Transmission...	H-65030
Hydraulic Oil Filter.....	H-51170	Hydraulic Oil Filter.....	H-85110	40 (CRANES) GMC 6V-53N	
D40K (DRILLING) CAT 3406		30EC (CRANES) IHC UC301 GAS		Hydraulic Oil Filter Transmission...	H-65030
Hydraulic Oil Filter.....	H-5517	Hydraulic Oil Filter.....	H-79411	400 CRAWLER (EXCAVATORS) DEUTZ F12L413	
Hydraulic Oil Filter.....	HC-7932	30EC (CRANES) PERKINS 6.354		Hydraulic Oil Filter.....	H-85110
Hydraulic Oil Filter.....	H-7983	Hydraulic Oil Filter.....	H-79411	40A WHEEL (EXCAVATORS) S/N: 100-2199	
PRIME MOVER (DRILLING) CAT 3208		30EC (EXCAVATORS) DETROITD 3-53		Hydraulic Oil Filter.....	H-79411
Hydraulic Oil Filter.....	H-5517	Hydraulic Oil Filter.....	H-79411	40B LOGGER (CRANES) CASE	
PRIME MOVER (DRILLING) DRILTECH 3306NA		30EC (EXCAVATORS) DROTT UD282 DIESEL		Hydraulic Oil Filter.....	H-79411
Hydraulic Oil Filter.....	H-5517	Hydraulic Oil Filter.....	H-79411	40B LOGGER (EXCAVATORS) DROTT DETROIT	
PRIME MOVER (DRILLING) IHC RD549		30EC (EXCAVATORS) IHC UC263 GAS		Hydraulic Oil Filter.....	H-79411
Hydraulic Oil Filter.....	H-5517	Hydraulic Oil Filter.....	H-79411	40B WHEEL (CRANES) DROTT DETROIT (S/N: 2200-6292775)	
DROTT		30EC SERIES A CRAWLER (EXCAVATORS) DETROITD 4-53N		Hydraulic Oil Filter.....	H-79411
115 (CRANES)		Hydraulic Oil Filter.....	H-79411	40B WHEEL (EXCAVATORS) DETROIT DIESEL (S/N: 2200-6292775)	
Hydraulic Oil Filter.....	H-71140	30EC SERIES A CRAWLER (EXCAVATORS) GMC 3-53N		Hydraulic Oil Filter.....	H-79411
Hydraulic Oil Filter.....	H-76050	Hydraulic Oil Filter.....	H-79411	40D (EXCAVATORS) DETROITD 4-53	
120CK SERIES B CRAWLER (CRANES)		30YM (EXCAVATORS) GMC		Hydraulic Oil Filter Transmission...	H-65030
Hydraulic Oil Filter.....	H-76050	Hydraulic Oil Filter.....	H-79411	Hydraulic Oil Filter.....	H-79411
Hydraulic Oil Filter.....	H-71140	30YM (EXCAVATORS) IHC UD-236		40D (EXCAVATORS) DETROITD 4-71	
125PB (CRANES) DEUTZ		Hydraulic Oil Filter.....	H-79411	Hydraulic Oil Filter Transmission...	H-65030
Hydraulic Oil Filter.....	H-76050	30YM (EXCAVATORS) IHC UC-221		Hydraulic Oil Filter.....	H-79411
Hydraulic Oil Filter.....	H-71140	Hydraulic Oil Filter.....	H-79411	Hydraulic Oil Filter.....	H-79411
1500 (CRANES) DETROITD 4-71					



ENGINE APPLICATION

MODEL/APPLICATION	SAKURA NO	MODEL/APPLICATION	SAKURA NO	MODEL/APPLICATION	SAKURA NO
DROTT		DROTT		DYNAPAC	
40D WHEEL (CRANES) S/N: 6292576-UP		75C (CRANES) DEUTZ		CA25 SERIES II (ROLLERS) DEUTZ F6L912	
Hydraulic Oil Filter.....	H-79411	Hydraulic Oil Filter.....	H-71140	Hydraulic Oil Filter.....	HC-5511
40EC (CRANES) DETROIT DIESEL		75P (CRANES)		CA251 (ROLLERS) CUMMINS 6BT5.9 , 1994-UP	
Hydraulic Oil Filter.....	H-79411	Hydraulic Oil Filter.....	H-85110	Hydraulic Oil Filter.....	HC-55260
40EC (CRANES) PERKINS 6.354 DIESEL		85CKB (CRANES) DEUTZ		CA251 (ROLLERS) CUMMINS 6BT5.9	
Hydraulic Oil Filter.....	H-79411	Hydraulic Oil Filter.....	H-71140	Hydraulic Oil Filter.....	HC-5511
40EC (EXCAVATORS) ALLISCHA 2900		90P (CRANES) DEUTZ		CA30 (ROLLERS) CAT 3208	
Hydraulic Oil Filter.....	H-79411	Hydraulic Oil Filter.....	H-85110	Hydraulic Oil Filter.....	HC-5511
40EC (EXCAVATORS) CASE 504BD		DURATECH		CA30 SERIES II (ROLLERS) CAT 3208	
Hydraulic Oil Filter.....	H-79411			Hydraulic Oil Filter.....	HC-5511
40EC (EXCAVATORS) CUMMINS 6V-352		H1100 (EQUIPMENT)		CA30 SERIES II (ROLLERS) DETROIT DIESEL	
Hydraulic Oil Filter.....	H-79411	Hydraulic Oil Filter.....	HC-19040	Hydraulic Oil Filter.....	HC-5511
40EC (EXCAVATORS) DETROIT 4-53		DYNAHOE		CA30 SERIES II (ROLLERS) DEUTZ F6L912	
Hydraulic Oil Filter.....	H-79411			Hydraulic Oil Filter.....	HC-5511
40EC (EXCAVATORS) DETROIT 4-71		140 (CONSTRUCTION EQUIPMENTS) GMC 3-53		CA301 (ROLLERS) CUMMINS 6BT5.9	
Hydraulic Oil Filter.....	H-79411	Hydraulic Oil Filter Transmission...	H-65030	Hydraulic Oil Filter.....	HC-5511
40EC SERIES B CRAWLER (EXCAVATORS)		190-4 (LOADERS) GMC 4-53N		CA50 (ROLLERS) CAT 3208	
Hydraulic Oil Filter.....	H-79411	Hydraulic Oil Filter Transmission...	H-65030	Hydraulic Oil Filter.....	H-51170
50D CRAWLER (CRANES) CASE (S/N: 6279926-UP)		200 (CONSTRUCTION EQUIPMENTS) GMC 4-53		CA51 (ROLLERS)	
Hydraulic Oil Filter.....	H-57030	Hydraulic Oil Filter Transmission...	H-65030	Hydraulic Oil Filter.....	HC-5511
50D CRAWLER (CRANES) DROTT DETROIT (S/N: 6279926-UP)		220E (EXCAVATORS) GMC 6V-53		CA511D (ROLLERS) DEUTZ	
Hydraulic Oil Filter.....	H-57030	Hydraulic Oil Filter Transmission...	H-65030	Hydraulic Oil Filter.....	HC-5511
50E CRAWLER (CRANES) DROTT DETROIT		300 C (CRANES) GMC 4-53N		CA512D (ROLLERS) CUMMINS 6BTAS.9 , 1996-UP	
Hydraulic Oil Filter.....	H-57030	Hydraulic Oil Filter Transmission...	H-65030	Hydraulic Oil Filter.....	HC-55190
50EC SERIES B CRAWLER (CRANES) CASE		AD (CONSTRUCTION EQUIPMENTS) GMC 3-53		CC21 (ROLLERS) DEUTZ F4L912	
Hydraulic Oil Filter.....	H-79411	Hydraulic Oil Filter.....	H-79411	Hydraulic Oil Filter.....	HC-5511
50EC SERIES B CRAWLER (CRANES) CASE (S/N: 550-UP)		Hydraulic Oil Filter.....	H-5405	CC21 SERIES II (ROLLERS) DEUTZ F4L912	
Hydraulic Oil Filter.....	H-79411	Hydraulic Oil Filter Transmission...	H-65030	Hydraulic Oil Filter.....	HC-5511
50EC SERIES B CRAWLER (CRANES) DROTT DETROIT		DYNAPAC		CC21 SERIES II (ROLLERS) DEUTZ F4L912	
Hydraulic Oil Filter.....	H-79411			Hydraulic Oil Filter.....	HC-5511
50EC SERIES B CRAWLER (CRANES) DROTT DETROIT (S/N: 550-UP)		CA12 (ROLLERS) DEUTZ F3L912		CC223 (ROLLERS)	
Hydraulic Oil Filter.....	H-79411	Hydraulic Oil Filter.....	HC-1822	Hydraulic Oil Filter.....	HC-55190
60C (CRANES) DEUTZ		CA25 (ROLLERS) CAT 3145		CC232 (ROLLERS) 1997	
Hydraulic Oil Filter.....	H-71140	Hydraulic Oil Filter.....	H-79411	Hydraulic Oil Filter.....	HC-55190
		Hydraulic Oil Filter.....	H-51170	CC42 (ROLLERS) CAT 3145	
		CA25 SERIES II (ROLLERS) CAT 3208		Hydraulic Oil Filter.....	H-51170
		Hydraulic Oil Filter.....	HC-5511		



ENGINE APPLICATION

MODEL/APPLICATION	SAKURA NO	MODEL/APPLICATION	SAKURA NO	MODEL/APPLICATION	SAKURA NO
DYNAPAC		EIMCO		EUCLID	
CC42 SERIES II (ROLLERS) CAT 3208		125 (LOADERS) GMC 4-71		43LDT (SCRAPERS)	
Hydraulic Oil Filter.....	HC-5511	Hydraulic Oil Filter Transmission...	H-65030	Hydraulic Oil Filter Transmission...	H-65030
CC42 SERIES II (ROLLERS) CUMMINS 6BT5.9		126 (LOADERS) GMC 6V-71		45LDT (SCRAPERS)	
Hydraulic Oil Filter.....	HC-5511	Hydraulic Oil Filter Transmission...	H-65030	Hydraulic Oil Filter Transmission...	H-65030
CC42 SERIES II (ROLLERS) DEUTZ F6L912		133B (LOADERS) GMC 4-71		49LDT (SCRAPERS) GMC 12V-71	
Hydraulic Oil Filter.....	HC-5511	Hydraulic Oil Filter Transmission...	H-65030	Hydraulic Oil Filter Transmission...	H-65030
CC422 (ROLLERS) CUMMINS 4BTA3.9 , 1995-UP		136 (LOADERS) GMC 6V-71		4LLD (SCRAPERS)	
Hydraulic Oil Filter.....	HC-55190	Hydraulic Oil Filter Transmission...	H-65030	Hydraulic Oil Filter Transmission...	H-65030
CC422C (ROLLERS) S/N: 62610431-UP		143 (LOADERS) GMC 4-53		5LLD (SCRAPERS) GMC DIESEL	
Hydraulic Oil Filter.....	HC-55190	Hydraulic Oil Filter Transmission...	H-65030	Hydraulic Oil Filter Transmission...	H-65030
CC42A (ROLLERS) CAT 3208		143B (LOADERS) GMC 4-71		65TD (SCRAPERS) EUCLID 6-110	
Hydraulic Oil Filter.....	H-51170	Hydraulic Oil Filter Transmission...	H-65030	Hydraulic Oil Filter Transmission...	H-65030
CC50 (ROLLERS) CAT 3208		165 (LOADERS) GMC 6V-53		65TD (SCRAPERS) EUCLID V-12	
Hydraulic Oil Filter.....	H-51170	Hydraulic Oil Filter Transmission...	H-65030	Hydraulic Oil Filter Transmission...	H-65030
CC50A (ROLLERS) CAT 3150		ERICKSON		66TD (SCRAPERS) CUMMINS	
Hydraulic Oil Filter.....	H-51170	LITTLE ERIC II 2542 (LOADERS) ONAN NHC		Hydraulic Oil Filter Transmission...	H-65030
CF43 (ROLLERS) DEUTZ F3L912		Hydraulic Oil Filter.....	HC-7932	6LLD (SCRAPERS) CUMMINS	
Hydraulic Oil Filter.....	HC-1822	EUCLID		Hydraulic Oil Filter Transmission...	H-65030
CT262 (COMPACTORS) CUMMINS 6CT8.3 , 1992-UP		10LD (SCRAPERS)		82FD (SCRAPERS)	
Hydraulic Oil Filter.....	H-51170	Hydraulic Oil Filter Transmission...	H-65030	Hydraulic Oil Filter Transmission...	H-65030
EIMCO		27LOT (SCRAPERS) GMC		91FD SERIES A (SCRAPERS)	
103 (LOADERS) GMC 4-53		Hydraulic Oil Filter Transmission...	H-65030	Hydraulic Oil Filter Transmission...	H-65030
Hydraulic Oil Filter Transmission...	H-65030	301TD (SCRAPERS) GMC		B100 (DUMP TRUCKS) GMC 16V-71N	
103B (LOADERS) GMC 4-71		Hydraulic Oil Filter Transmission...	H-65030	Hydraulic Oil Filter Transmission...	H-65030
Hydraulic Oil Filter Transmission...	H-65030	30LOT (SCRAPERS) GMC		C6 (DUMP TRUCKS) GMC 6-71	
106 (LOADERS) GMC 6V-71		Hydraulic Oil Filter Transmission...	H-65030	Hydraulic Oil Filter Transmission...	H-65030
Hydraulic Oil Filter Transmission...	H-65030	33LDT (SCRAPERS)		Hydraulic Oil Filter.....	H-7983
115 (LOADERS) GMC 4-71		Hydraulic Oil Filter Transmission...	H-65030	CH120 (DUMP TRUCKS) CUMMINS VT-1710	
Hydraulic Oil Filter Transmission...	H-65030	34LDT (SCRAPERS)		Hydraulic Oil Filter Transmission...	H-65030
123 (LOADERS) GMC 4-53		Hydraulic Oil Filter Transmission...	H-65030	R105 (DUMP TRUCKS) GMC 12V-149T	
Hydraulic Oil Filter Transmission...	H-65030	37LDT (SCRAPERS)		Hydraulic Oil Filter Transmission...	H-65030
123B (LOADERS) GMC 4-71		Hydraulic Oil Filter Transmission...	H-65030	R-22 SERIES FD (DUMP TRUCKS) GMC 6-71	
Hydraulic Oil Filter Transmission...	H-65030	3LLD (SCRAPERS)		Hydraulic Oil Filter Transmission...	H-65030
		Hydraulic Oil Filter Transmission...	H-65030	R 25 (DUMP TRUCKS) CUMMINS	



ENGINE APPLICATION

MODEL/APPLICATION	SAKURA NO	MODEL/APPLICATION	SAKURA NO	MODEL/APPLICATION	SAKURA NO
EUCLID		EUCLID		FAI (KOMATSU UTILITY EUROPE)	
R 25 (DUMP TRUCKS) CUMMINS Hydraulic Oil Filter Transmission...	H-65030	SS-40 (SCRAPERS) Hydraulic Oil Filter Transmission...	H-65030	215 (EXCAVATORS) YANMAR 3TNC78E Hydraulic Oil Filter.....	H-5608
R-27 SERIES TD (DUMP TRUCKS) GMC 6-110 Hydraulic Oil Filter Transmission...	H-65030	TC6 (LOADERS) GMC 6-71 Hydraulic Oil Filter Transmission...	H-65030	338 (CONSTRUCTION & MINING) Hydraulic Oil Filter.....	HC-7906
R 30 (DUMP TRUCKS) CUMMINS NT-335 Hydraulic Oil Filter Transmission...	H-65030	Hydraulic Oil Filter.....	H-7983	Hydraulic Oil Filter.....	HC-7906
R 30 (DUMP TRUCKS) GMC 12V-71 Hydraulic Oil Filter Transmission...	H-65030	EOBUS		692 (CONSTRUCTION & MINING) Hydraulic Oil Filter.....	HC-7906
R 30 (DUMP TRUCKS) GMC 6-110 Hydraulic Oil Filter Transmission...	H-65030	CAPACITY O 530 GL (BUSES) MERCEDES OM457HLA (S/N: EURO 4-UP) , 2007-UP Hydraulic Oil Filter Transmission....	H-7102	Hydraulic Oil Filter.....	HC-7906
R 30 (DUMP TRUCKS) GMC 6-110 Hydraulic Oil Filter Transmission...	H-65030	CITARO CNG O 530 (BUSES) MERCEDES M447 HLAG , 2001-UP Hydraulic Oil Filter Transmission....	H-7102	Hydraulic Oil Filter.....	HC-7906
R-35 SERIES (DUMP TRUCKS) GMC 16V-71 Hydraulic Oil Filter Transmission...	H-65030	CITARO K O 530 (BUSES) MERCEDES OM906LA , 2006-UP Hydraulic Oil Filter Transmission....	H-7102	698 (CONSTRUCTION & MINING) Hydraulic Oil Filter.....	HC-7906
R40 (DUMP TRUCKS) CUMMINS NT-6 (QTY 2) Hydraulic Oil Filter Transmission...	H-65030	CITARO LE O 530 (BUSES) MERCEDES OM457HLA , 2005-UP Hydraulic Oil Filter Transmission....	H-7102	898 (CONSTRUCTION & MINING) PERKINS Hydraulic Oil Filter.....	HC-7913
R40 (DUMP TRUCKS) CUMMINS V12-525 Hydraulic Oil Filter Transmission...	H-65030	CITARO O 530 (BUSES) MERCEDES OM457HLA (S/N: EURO 4-UP) , 2006-UP Hydraulic Oil Filter Transmission....	H-7102	Hydraulic Oil Filter.....	HC-7913
R40 (DUMP TRUCKS) GMC 16V-71 Hydraulic Oil Filter Transmission...	H-65030	CITARO O 530 (BUSES) MERCEDES OM457HLA (S/N: EURO4-UP) , 2006-UP Hydraulic Oil Filter Transmission....	H-7102	MIN TRAX 212 (EXCAVATORS) PERKINS Hydraulic Oil Filter.....	HC-7905
R40 (DUMP TRUCKS) GMC 6-71(QTY 2) DIESEL Hydraulic Oil Filter Transmission...	H-65030	CITARO O 530 (BUSES) MERCEDES OM457HLA (S/N: EURO 3-UP) , 2004-UP Hydraulic Oil Filter Transmission....	H-7102	MIN TRAX 218 (EXCAVATORS) YANMAR 3TNC78E Hydraulic Oil Filter.....	H-5608
R50 (DUMP TRUCKS) CUMMINS NRTO-6 OR (QTY 2) Hydraulic Oil Filter Transmission...	H-65030	CITARO O 530 (BUSES) MERCEDES OM457HLA (S/N: EURO 3-UP) , 2004-UP Hydraulic Oil Filter Transmission....	H-7102	PANDA 320B (EXCAVATORS) PERKINS Hydraulic Oil Filter.....	HC-7905
R50 (DUMP TRUCKS) CUMMINS NT-335 (QTY 2) Hydraulic Oil Filter Transmission...	H-65030	CITARO O 530 (BUSES) MERCEDES OM457HLA (S/N: EURO 3-UP) , 2004-UP Hydraulic Oil Filter Transmission....	H-7102	PANDA 330 (EXCAVATORS) PERKINS Hydraulic Oil Filter.....	HC-7906
R50 (DUMP TRUCKS) DETROIT 16V-71N Hydraulic Oil Filter Transmission...	H-65030	CITARO O 530 (BUSES) MERCEDES OM906HLA (S/N: EURO 3-5-UP) , 2004-UP Hydraulic Oil Filter Transmission....	H-7102	PANDA 330B (EXCAVATORS) PERKINS Hydraulic Oil Filter.....	HC-7906
R50 (DUMP TRUCKS) GMC 6-110 (QTY 2) DIESEL Hydraulic Oil Filter Transmission...	H-65030	CITARO O 530 (BUSES) MERCEDES OM906HLA (S/N: EURO 3-5-UP) , 2004-UP Hydraulic Oil Filter Transmission....	H-7102	PANDA 338 (EXCAVATORS) PERKINS Hydraulic Oil Filter.....	HC-7906
RX-105 (DUMP TRUCKS) DETROIT 12V-149T Hydraulic Oil Filter Transmission...	H-65030	CITARO O 530 (BUSES) MERCEDES OM906LA (S/N: EURO 3-5-UP) , 2004-UP Hydraulic Oil Filter Transmission....	H-7102	PANDA 340 (EXCAVATORS) PERKINS Hydraulic Oil Filter.....	HC-7906
S28 (SCRAPERS) GMC 12V-71 Hydraulic Oil Filter Transmission...	H-65030	CITARO O 530 (BUSES) MERCEDES OM906LA (S/N: EURO 3-5-UP) , 2004-UP Hydraulic Oil Filter Transmission....	H-7102	PANDA 340 (EXCAVATORS) PERKINS Hydraulic Oil Filter.....	HC-7906
SS-28 (SCRAPERS) Hydraulic Oil Filter Transmission...	H-65030	CITARO O 530 (BUSES) MERCEDES OM906HLA , 1998-UP Hydraulic Oil Filter Transmission....	H-7102	PANDA 380 (EXCAVATORS) FAI FIAT-AIFO Hydraulic Oil Filter.....	HC-7906
		CITARO O 530 (BUSES) MERCEDES OM906HLA , 1998-UP Hydraulic Oil Filter Transmission....	H-7102	PC10 (EXCAVATORS) YANMAR 3TNE82 Hydraulic Oil Filter.....	H-5607
				Hydraulic Oil Filter.....	H-5608
		EVO		PC20 (EXCAVATORS) YANMAR 3TNE84 Hydraulic Oil Filter.....	H-5607
		TRASH COMPACTOR (COMPACTORS) GMC 6 CYL 292 Hydraulic Oil Filter.....	H-79411	Hydraulic Oil Filter.....	H-5608
		Hydraulic Oil Filter.....	H-51170		
		FAI (KOMATSU UTILITY EUROPE)			



ENGINE APPLICATION

MODEL/APPLICATION	SAKURA NO	MODEL/APPLICATION	SAKURA NO	MODEL/APPLICATION	SAKURA NO
FAI (KOMATSU UTILITY EUROPE)		FAUN-FRISCH		FIAT	
PC45 (EXCAVATORS) YANMAR 4TNE84		K40.4 (DUMP TRUCKS) DEUTZ		Hydraulic Oil Filter.....	HC-45110
Hydraulic Oil Filter.....	H-5608	Hydraulic Oil Filter Transmission...	H-65030	3830 (TRACTORS)	
Hydraulic Oil Filter.....	H-5607	KF400 (CRANE TRACTORS) MTU MB6V331TA40		Hydraulic Oil Filter.....	HC-45110
SYNTHESIS 100DT (LOADERS)		Hydraulic Oil Filter Transmission...	H-65030	4030 (TRACTORS)	
Hydraulic Oil Filter.....	HC-7906	FECON		Hydraulic Oil Filter.....	HC-45110
Hydraulic Oil Filter.....	HC-7913	FTX140-FM (FOREST EQUIPMENTS) JDEERE 4045H		4230 (TRACTORS)	
SYNTHESIS 555 (LOADERS)		Hydraulic Oil Filter.....	HC-55300	Hydraulic Oil Filter.....	HC-45110
Hydraulic Oil Filter.....	HC-7906	FENDT		45-66 (TRACTORS)	
SYNTHESIS 565 (LOADERS)		6280 C (COMBINES) DEUTZ BF6M1013FC , 2002-UP		Hydraulic Oil Filter.....	HC-45110
Hydraulic Oil Filter.....	HC-7906	Hydraulic Oil Filter.....	HC-62020	466 (TRACTORS) FIAT	
SYNTHESIS 575 (LOADERS)		6300 (COMBINES) DEUTZ BF6M1015 , 1999-UP		Hydraulic Oil Filter.....	HC-45110
Hydraulic Oil Filter.....	HC-7906	Hydraulic Oil Filter.....	HC-62020	50-66 (TRACTORS)	
SYNTHESIS 590 (LOADERS)		6330 (COMBINES) DEUTZ BF6M1015 , 1999-UP		Hydraulic Oil Filter.....	HC-45110
Hydraulic Oil Filter.....	HC-7906	Hydraulic Oil Filter.....	HC-62020	55-65 (TRACTORS)	
SYNTHESIS 692 (LOADERS) PERKINS 1004.4T		FIAT		Hydraulic Oil Filter.....	HC-45110
Hydraulic Oil Filter.....	HC-7906	100-90 (TRACTORS) FIAT 8065.05		55-66 (TRACTORS)	
FARMHAND		Hydraulic Oil Filter.....	HC-45110	Hydraulic Oil Filter.....	HC-45110
FORAGE HARVESTER (HARVESTERS) DETROIT 6-71		110-90 (TRACTORS) FIAT 8065.05		55-75 (TRACTORS)	
Hydraulic Oil Filter.....	H-79411	Hydraulic Oil Filter.....	HC-45110	Hydraulic Oil Filter.....	HC-45110
RANCHHAND HAY STACKER (HAY STACKERS)		115-90 (TRACTORS)		55-85 (TRACTORS)	
Hydraulic Oil Filter.....	H-51170	Hydraulic Oil Filter.....	HC-45110	Hydraulic Oil Filter.....	HC-45110
FAUN-FRISCH		1180 (TRACTORS) FIAT 8065		55-90 (TRACTORS) FIAT 8045.05	
2000C (LOADERS)		Hydraulic Oil Filter.....	HC-45110	Hydraulic Oil Filter.....	HC-45110
Hydraulic Oil Filter.....	H-76050	1280 (TRACTORS)		565C (TRACTORS)	
F1310 (LOADERS) DEUTZ F6L913		Hydraulic Oil Filter.....	HC-45110	Hydraulic Oil Filter.....	HC-45110
Hydraulic Oil Filter.....	HC-76110	130-90 (TRACTORS) FIAT 8065		60-56 (TRACTORS)	
F1310 (LOADERS) DEUTZ F6L912		Hydraulic Oil Filter.....	HC-45110	Hydraulic Oil Filter.....	HC-45110
Hydraulic Oil Filter.....	HC-76110	1380 (TRACTORS)		60.66 (TRACTORS) FIAT 8035.06	
F155 (GRADERS) DEUTZ F5L413		Hydraulic Oil Filter.....	HC-45110	Hydraulic Oil Filter.....	HC-45110
Hydraulic Oil Filter.....	H-71140	160-90 (TRACTORS) FIAT 8365		60-65 (TRACTORS)	
F205 (GRADERS) DEUTZ F6L413		Hydraulic Oil Filter.....	HC-45110	Hydraulic Oil Filter.....	HC-45110
Hydraulic Oil Filter.....	HC-6802	180-90 (TRACTORS) FIAT 8365		6075 (TRACTORS)	
K22.2B (DUMP TRUCKS)		Hydraulic Oil Filter.....	HC-45110	Hydraulic Oil Filter.....	HC-45110
Hydraulic Oil Filter Transmission...	H-65030	1880 (TRACTORS)		60-85 (TRACTORS)	



ENGINE APPLICATION

MODEL/APPLICATION	SAKURA NO	MODEL/APPLICATION	SAKURA NO	MODEL/APPLICATION	SAKURA NO
FIAT		FIAT		FIAT-AGRI	
60-85 (TRACTORS)		80-65 (TRACTORS) FIAT		110-90 (TRACTORS) FIATAGRI 8065.05 , 1990-UP	
Hydraulic Oil Filter.....	HC-45110	Hydraulic Oil Filter.....	HC-45110	Hydraulic Oil Filter.....	HC-45110
60-90 (TRACTORS) FIAT 8045.05		80-75 (TRACTORS)		115-90 (TRACTORS) FIATAGRI 8065.05 , 1984-UP	
Hydraulic Oil Filter.....	HC-45110	Hydraulic Oil Filter.....	HC-45110	Hydraulic Oil Filter.....	HC-45110
60-93 (TRACTORS)		80-90 (TRACTORS) FIAT 8045.5		1180 (TRACTORS) 1980-UP	
Hydraulic Oil Filter.....	HC-45110	Hydraulic Oil Filter.....	HC-45110	Hydraulic Oil Filter.....	HC-45110
62-85 (TRACTORS)		82-85 (TRACTORS) FIAT		130-90 (TRACTORS) FIATAGRI 8065.25 , 1984-UP	
Hydraulic Oil Filter.....	HC-45110	Hydraulic Oil Filter.....	HC-45110	Hydraulic Oil Filter.....	HC-45110
65-56 (TRACTORS)		82-93 (TRACTORS)		1380 (TRACTORS) FIAT 8065 , 1980-UP	
Hydraulic Oil Filter.....	HC-45110	Hydraulic Oil Filter.....	HC-45110	Hydraulic Oil Filter.....	HC-45110
65-66 (TRACTORS)		85-90 (TRACTORS)		140-90 DT (TRACTORS) FIATAGRI 8065.25 , 1984-UP	
Hydraulic Oil Filter.....	HC-45110	Hydraulic Oil Filter.....	HC-45110	Hydraulic Oil Filter.....	HC-45110
65-90 (TRACTORS)		88-85 (TRACTORS) FIAT		140-90 (TRACTORS)	
Hydraulic Oil Filter.....	HC-45110	Hydraulic Oil Filter.....	HC-45110	Hydraulic Oil Filter.....	HC-45110
665C (TRACTORS) FIAT		88-93 (TRACTORS)		1580 (TRACTORS) FIAT 8365 , 1981-UP	
Hydraulic Oil Filter.....	HC-45110	Hydraulic Oil Filter.....	HC-45110	Hydraulic Oil Filter.....	HC-45110
70-56 (TRACTORS) 1975-UP		88-94 (TRACTORS)		160-90 DT (TRACTORS) FIATAGRI 8365.25 , 1984-UP	
Hydraulic Oil Filter.....	HC-45110	Hydraulic Oil Filter.....	HC-45110	Hydraulic Oil Filter.....	HC-45110
70-66 (TRACTORS) 1975-UP		90-90 (TRACTORS) FIAT 8055.05		160-90 (TRACTORS) 1984-UP	
Hydraulic Oil Filter.....	HC-45110	Hydraulic Oil Filter.....	HC-45110	Hydraulic Oil Filter.....	HC-45110
70-65 (TRACTORS) FIAT 3 CYL DIESEL , 1975-UP		DUCATO (VANS) 1.8 169 B , 1800, 1982-1988		180-90 (TRACTORS) FIATAGRI 8365.25 , 1984-UP	
Hydraulic Oil Filter.....	HC-45110	Hydraulic Oil Filter Transmission..	HC-45150	Hydraulic Oil Filter.....	HC-45110
70-66F (TRACTORS) 1975-UP		DUCATO (VANS) 1.8 XM7T , 1800, 1982-1988		1880 (TRACTORS) 1982-UP	
Hydraulic Oil Filter.....	HC-45110	Hydraulic Oil Filter Transmission..	HC-45150	Hydraulic Oil Filter.....	HC-45110
70-75 (TRACTORS) FIAT 8045-06 , 1975-UP		DUCATO (VANS) 2.0 XN 1T , 2000, 1982-1990		55-46 (TRACTORS) FIATAGRI 8035.06 , 1984-2002	
Hydraulic Oil Filter.....	HC-45110	Hydraulic Oil Filter Transmission..	HC-45150	Hydraulic Oil Filter.....	HC-45110
70-90 (TRACTORS) FIAT 8045.05 , 1975-UP		DUCATO (VANS) 2.0 XN 1T , 2000, 1982-1985		55.66 (TRACTORS) FIATAGRI 8035.06 , 1985	
Hydraulic Oil Filter.....	HC-45110	Hydraulic Oil Filter Transmission..	HC-45150	Hydraulic Oil Filter.....	HC-45110
72-85 (TRACTORS) FIAT , 1975-UP		FH200-LC (EXCAVATORS) FIAT 8065		55-88 (TRACTORS)	
Hydraulic Oil Filter.....	HC-45110	Hydraulic Oil Filter.....	H-2703	Hydraulic Oil Filter.....	HC-45110
765C (TRACTORS) FIAT , 1975-UP		FIAT-AGRI		55-90 (TRACTORS) FIATAGRI 8045.05 , 1984-UP	
Hydraulic Oil Filter.....	HC-45110			Hydraulic Oil Filter.....	HC-45110
80-66 (TRACTORS) IVECO 8045E		100-90 (TRACTORS) FIATAGRI 8065.06 , 1984-UP		60-76 DT (TRACTORS) FIATAGRI 8035.06 , 1985-UP	
Hydraulic Oil Filter.....	HC-45110	Hydraulic Oil Filter.....	HC-45110	Hydraulic Oil Filter.....	HC-45110



ENGINE APPLICATION

MODEL/APPLICATION	SAKURA NO	MODEL/APPLICATION	SAKURA NO	MODEL/APPLICATION	SAKURA NO
FIAT-AGRI		FIAT-AGRI		FIAT-ALLIS	
60-93 (TRACTORS) FIATAGRI 8045.05 , 1988-1998		L85 (TRACTORS) FIATAGRI 8045.05 , 1990-1998		AD18 (CRAWLERS)	
Hydraulic Oil Filter.....	HC-45110	Hydraulic Oil Filter.....	HC-7001	Hydraulic Oil Filter Transmission...	H-65030
65-66 (TRACTORS) FIATAGRI 8045.05 , 1984-UP		Hydraulic Oil Filter.....	HC-5506	BD10B (CRAWLERS)	
Hydraulic Oil Filter.....	HC-45110	L95 (TRACTORS) FIATAGRI 8045.05 , 1990-1998		Hydraulic Oil Filter Transmission...	H-65030
65-88 (TRACTORS) FIAT 8045-06 , 1984-UP		Hydraulic Oil Filter.....	HC-7001	FD30 (CRAWLERS) FIAT 8285 TURBO	
Hydraulic Oil Filter.....	HC-45110	M135 (TRACTORS)		Hydraulic Oil Filter Transmission...	H-65030
65-93 (TRACTORS) FIAT 8045-06 , 1988-1998		Hydraulic Oil Filter.....	HC-1905	FL20 (CRAWLERS) FIAT 8215.22 TURBO	
Hydraulic Oil Filter.....	HC-45110	Hydraulic Oil Filter.....	HC-5504	Hydraulic Oil Filter Transmission...	H-65030
70-66 (TRACTORS) FIATAGRI 8045.05 , 1984-UP		WINNER F100 (TRACTORS) FIATAGRI 8065.06 , 1991		FL4M (CRAWLERS)	
Hydraulic Oil Filter.....	HC-45110	Hydraulic Oil Filter.....	HC-45110	Hydraulic Oil Filter.....	HC-7913
80-76 (TRACTORS) FIATAGRI 8045.05 , 1985-UP		WINNER F110 HI-LO (TRACTORS) FIATAGRI 8065.05 , 1991		FL5 (CRAWLERS)	
Hydraulic Oil Filter.....	HC-45110	Hydraulic Oil Filter.....	HC-45110	Hydraulic Oil Filter.....	HC-7913
80-88 (TRACTORS) FIATAGRI 8045.05 , 1984-UP		FIAT-ALLIS		FL 7 (CRAWLERS)	
Hydraulic Oil Filter.....	HC-45110	11B (CRAWLERS) S/N: 22976-UP		Hydraulic Oil Filter.....	HC-7913
80-90 (TRACTORS) FIATAGRI 8045.05 , 1984-UP		Hydraulic Oil Filter Transmission...	H-65030	FL 7 (CRAWLERS)	
Hydraulic Oil Filter.....	HC-45110	14C (CRAWLERS) FIAT (S/N: T0-050101)		Hydraulic Oil Filter.....	HC-7913
82-86 (TRACTORS) 1986-UP		Hydraulic Oil Filter Transmission...	H-65030	FR130 (LOADERS) 1993	
Hydraulic Oil Filter.....	HC-45110	16B (CRAWLERS) S/N: 19510301-UP		Hydraulic Oil Filter Transmission...	HC-2701
82-93 (TRACTORS) FIATAGRI 8045.05 , 1988-1998		Hydraulic Oil Filter Transmission...	H-65030	FR160 (TRACTORS) FIATALLS 8365.25 , 1993	
Hydraulic Oil Filter.....	HC-45110	21C (CRAWLERS) IVECO		Hydraulic Oil Filter Transmission...	HC-2701
85-90 (TRACTORS) 1992		Hydraulic Oil Filter.....	H-5503	FR10 (LOADERS) FIAT	
Hydraulic Oil Filter.....	HC-45110	545 (LOADERS)		Hydraulic Oil Filter.....	HC-6501
90-90 (TRACTORS) FIATAGRI 8055.05 , 1984-UP		Hydraulic Oil Filter.....	H-5503	FR10 (LOADERS) FIAT 8065T	
Hydraulic Oil Filter.....	HC-45110	545B (LOADERS) FIATALLS A-C 2900 MKII		Hydraulic Oil Filter.....	HC-6501
Hydraulic Oil Filter.....	HC-5506	Hydraulic Oil Filter.....	H-5503	FR10B (LOADERS) FIAT	
L60 (TRACTORS) FIAT 8045-06 , 1990-1998		745C (LOADERS)		Hydraulic Oil Filter.....	HC-7913
Hydraulic Oil Filter.....	HC-7001	Hydraulic Oil Filter.....	H-5503	FR15 (LOADERS) FIAT 8365 TURBO	
Hydraulic Oil Filter.....	HC-5506	AD14 (CRAWLERS)		Hydraulic Oil Filter.....	HC-6501
L65 (TRACTORS) FIAT 8045-06 , 1990-1998		Hydraulic Oil Filter Transmission...	H-65030	FR20 (LOADERS) FIAT 8215	
Hydraulic Oil Filter.....	HC-7001	AD14B (CRAWLERS)		Hydraulic Oil Filter.....	HC-6501
L75 (TRACTORS) FIAT 8045-06 , 1990-1998		Hydraulic Oil Filter Transmission...	H-65030	Hydraulic Oil Filter.....	H-5503
Hydraulic Oil Filter.....	HC-7001	AD10 (CRAWLERS) FIAT 8365.05		FR20 (LOADERS) FIAT 8215T (S/N: 500951-UP)	
		Hydraulic Oil Filter Transmission...	H-65030	Hydraulic Oil Filter.....	H-5503
		AD14C (CRAWLERS) FIAT 8205.05		FR7 (LOADERS)	
		Hydraulic Oil Filter Transmission...	H-65030	Hydraulic Oil Filter.....	HC-7913



ENGINE APPLICATION

MODEL/APPLICATION	SAKURA NO	MODEL/APPLICATION	SAKURA NO	MODEL/APPLICATION	SAKURA NO
FIAT-ALLIS		FIAT HITACHI		FIAT HITACHI	
FR7B (LOADERS)		Hydraulic Oil Filter.....	H-2719	EX215W (BACKHOE LOADERS)	
Hydraulic Oil Filter.....	HC-7913	EX22 (BACKHOE LOADERS)		IVECO	
FR9 (LOADERS)		S/N: 00536-UP		Hydraulic Oil Filter.....	H-2706
Hydraulic Oil Filter.....	HC-7913	Hydraulic Oil Filter.....	H-2719	Hydraulic Oil Filter.....	H-2703
FR9B (LOADERS)		EX22 (BACKHOE LOADERS)		EX215W (BACKHOE LOADERS)	
Hydraulic Oil Filter.....	HC-7913	S/N: T0-00461		IVECO (S/N: ZEF208MM00000118-UP)	
FR9C (LOADERS)		Hydraulic Oil Filter.....	H-2719	Hydraulic Oil Filter.....	H-2703
Hydraulic Oil Filter.....	HC-7913	EX22 (CONSTRUCTION & MINING)		Hydraulic Oil Filter.....	H-2706
FR9C (LOADERS)		00462-00535		EX355 (BACKHOE LOADERS)	
Hydraulic Oil Filter.....	HC-7913	Hydraulic Oil Filter.....	H-2719	Hydraulic Oil Filter.....	H-2703
FIAT HITACHI		EX22 (CONSTRUCTION & MINING)		EX300R (BACKHOE LOADERS)	
CX500 (EXCAVATORS)		461		Hydraulic Oil Filter.....	H-2719
FIATHTCH H07C-T		Hydraulic Oil Filter.....	H-2719	EX40-2 (BACKHOE LOADERS)	
Hydraulic Oil Filter.....	HC-5602	EX22 (CONSTRUCTION & MINING)		Hydraulic Oil Filter.....	H-2712
Hydraulic Oil Filter.....	H-2706	536		EX455 (BACKHOE LOADERS)	
Hydraulic Oil Filter.....	H-2719	Hydraulic Oil Filter.....	H-2719	Hydraulic Oil Filter Full Flow.....	HC-7901
D150 (DOZERS)		EX25 (BACKHOE LOADERS)		Hydraulic Oil Filter.....	H-2703
CUMMINS 6BTAA5.9		S/N: 00175-UP		Hydraulic Oil Filter.....	HC-76080
Hydraulic Oil Filter.....	HC-5508	Hydraulic Oil Filter.....	H-2719	EX455-5 (BACKHOE LOADERS)	
D255 (DOZERS)		EX25 (CONSTRUCTION & MINING)		ISUZU 6RB1T	
CUMMINS 6CTAA8.3		174		Hydraulic Oil Filter.....	H-2709
Hydraulic Oil Filter.....	HC-5508	Hydraulic Oil Filter.....	H-2719	Hydraulic Oil Filter.....	H-2703
D350 (DOZERS)		EX25 (CONSTRUCTION & MINING)		EX500R (BACKHOE LOADERS)	
CUMMINS QSM11-C		175		Hydraulic Oil Filter.....	H-2703
Hydraulic Oil Filter.....	HC-5508	Hydraulic Oil Filter.....	H-2719	EX60 (BACKHOE LOADERS)	
EX15 (BACKHOE LOADERS)		EX22-2 (BACKHOE LOADERS)		Hydraulic Oil Filter.....	H-2703
Hydraulic Oil Filter.....	HC-5807	Hydraulic Oil Filter.....	H-2712	EX60-2 (BACKHOE LOADERS)	
Hydraulic Oil Filter.....	H-2712	Hydraulic Oil Filter.....	H-2719	Hydraulic Oil Filter.....	H-2714
EX122 (BACKHOE LOADERS)		EX255 (BACKHOE LOADERS)		EX600-2 (BACKHOE LOADERS)	
Hydraulic Oil Filter.....	HC-5807	CUMMINS		Hydraulic Oil Filter.....	H-2703
Hydraulic Oil Filter.....	H-2712	Hydraulic Oil Filter.....	H-2706	EX600R (BACKHOE LOADERS)	
EX135 (BACKHOE LOADERS)		Hydraulic Oil Filter.....	H-2703	Hydraulic Oil Filter.....	H-2703
Hydraulic Oil Filter.....	H-2703	EX215 (BACKHOE LOADERS)		EX600 (BACKHOE LOADERS)	
Hydraulic Oil Filter.....	H-2704	Hydraulic Oil Filter.....	H-2703	Hydraulic Oil Filter.....	H-2703
Hydraulic Oil Filter.....	H-2706	EX235 (BACKHOE LOADERS)		EX600R/URG (BACKHOE LOADERS)	
EX165 (BACKHOE LOADERS)		Hydraulic Oil Filter.....	H-2703	ISUZU 43B1	
ISUZU		EX285 (BACKHOE LOADERS)		Hydraulic Oil Filter.....	H-2703
Hydraulic Oil Filter.....	H-2704	CUMMINS		Hydraulic Oil Filter.....	H-2709
EX165W (BACKHOE LOADERS)		Hydraulic Oil Filter.....	H-2706	EX700 (BACKHOE LOADERS)	
CUMMINS		Hydraulic Oil Filter.....	H-2703	Hydraulic Oil Filter.....	H-2703
Hydraulic Oil Filter.....	H-2704	EX285 (BACKHOE LOADERS)		EX800 (BACKHOE LOADERS)	
EX135W (BACKHOE LOADERS)		ISUZU 6BG1-TRA06		Hydraulic Oil Filter.....	H-2703
CUMMINS		Hydraulic Oil Filter.....	H-2703	Hydraulic Oil Filter.....	H-2703
Hydraulic Oil Filter.....	H-2704	EX22 (BACKHOE LOADERS)		Hydraulic Oil Filter.....	H-2703
EX22 (BACKHOE LOADERS)		S/N: 00462-00535		Hydraulic Oil Filter.....	H-2703



ENGINE APPLICATION

MODEL/APPLICATION	SAKURA NO	MODEL/APPLICATION	SAKURA NO	MODEL/APPLICATION	SAKURA NO
FIAT HITACHI		FIAT HITACHI		FIAT HITACHI	
EX90 (BACKHOE LOADERS)		FH270.3 (EXCAVATORS) CUMMINS 6CT8.3		FR130 (LOADERS) FIAT 8065T , 1990-UP	
Hydraulic Oil Filter.....	H-2703	Hydraulic Oil Filter.....	H-2703	Hydraulic Oil Filter Transmission...	HC-2701
Hydraulic Oil Filter.....	H-2714	Hydraulic Oil Filter.....	H-2706	FR160 (LOADERS) FIAT 8365T , 1990-UP	
Hydraulic Oil Filter.....	H-2704	FH200-LC (EXCAVATORS) FIAT 8065		Hydraulic Oil Filter Transmission...	HC-2701
FB100 (BACKHOE LOADERS) FIAT HITACHI COMPACT LINE		Hydraulic Oil Filter.....	H-2703	FR10B (LOADERS)	
Hydraulic Oil Filter.....	HC-7001	FH22.2 (EXCAVATORS) FIATHTCH COMPACT LINE		Hydraulic Oil Filter.....	HC-7913
FB100 (BACKHOE LOADERS) FIATHTCH COMPACT LINE		Hydraulic Oil Filter.....	H-2712	FR12B (LOADERS)	
Hydraulic Oil Filter.....	HC-5506	FH240 (EXCAVATORS)		Hydraulic Oil Filter.....	H-5503
FB110 (BACKHOE LOADERS) FIAT HITACHI COMPACT LINE		Hydraulic Oil Filter.....	H-2703	Hydraulic Oil Filter.....	HC-6501
Hydraulic Oil Filter.....	HC-7001	FH300 (EXCAVATORS) FIATHTCH 8365.SI.11.ALL011 , 1988-UP		FR130-2 (LOADERS) IVECO	
FB110 (BACKHOE LOADERS) FIATHTCH COMPACT LINE		Hydraulic Oil Filter.....	H-2706	Hydraulic Oil Filter Transmission...	HC-2701
Hydraulic Oil Filter.....	HC-5506	Hydraulic Oil Filter.....	H-2703	FR15B (LOADERS)	
FB200-2 (BACKHOE LOADERS)		FH330.3 (EXCAVATORS) ISUZU 6SD1T		Hydraulic Oil Filter.....	HC-6501
Hydraulic Oil Filter.....	HC-5506	Hydraulic Oil Filter.....	H-2703	Hydraulic Oil Filter.....	H-5503
Hydraulic Oil Filter.....	HC-57020	FH30.2 (EXCAVATORS) FIATHTCH COMPACT LINE		FR160-2 (LOADERS) IVECO	
FB90 (BACKHOE LOADERS) FIAT HITACHI COMPACT LINE		Hydraulic Oil Filter.....	H-2712	Hydraulic Oil Filter Transmission...	HC-2701
Hydraulic Oil Filter.....	HC-7001	FH300.3 (EXCAVATORS) 1988-UP		FR20B (LOADERS)	
FB90 (BACKHOE LOADERS) FIATHTCH COMPACT LINE		Hydraulic Oil Filter.....	H-2703	Hydraulic Oil Filter.....	HC-6501
Hydraulic Oil Filter.....	HC-5506	FH330 (EXCAVATORS) ISUZU		Hydraulic Oil Filter.....	H-5503
FD255 (CRAWLER DOZERS)		Hydraulic Oil Filter.....	H-5505	FR220 (LOADERS) IVECO , 1991-UP	
Hydraulic Oil Filter.....	HC-5508	FH35.2 (EXCAVATORS) FIATHTCH COMPACT LINE		Hydraulic Oil Filter Transmission...	HC-2701
FH130 (EXCAVATORS) FIATHTCH 8045.SI.25.ALL001		Hydraulic Oil Filter.....	H-2712	Hydraulic Oil Filter.....	HC-57030
Hydraulic Oil Filter.....	H-2704	FH400 (EXCAVATORS) FIAT 8215.22.400 , 1988-UP		FR220-2 (LOADERS) IVECO	
Hydraulic Oil Filter.....	H-2703	Hydraulic Oil Filter.....	H-2703	Hydraulic Oil Filter Transmission...	HC-2701
FH15.2 (EXCAVATORS) FIATHTCH COMPACT LINE		FH450-3 (EXCAVATORS)		FR70 (LOADERS) 1991-UP	
Hydraulic Oil Filter.....	H-2712	Hydraulic Oil Filter.....	H-2703	Hydraulic Oil Filter.....	HC-7913
Hydraulic Oil Filter.....	HC-5807	FH40.2 (EXCAVATORS) FIATHTCH COMPACT LINE		FR90 (LOADERS) IVECO , 1991-UP	
FH150-3 (EXCAVATORS) IVECO		Hydraulic Oil Filter.....	H-2712	Hydraulic Oil Filter.....	HC-7913
Hydraulic Oil Filter.....	H-2704	FH45.2 (EXCAVATORS) FIATHTCH COMPACT LINE		FR9B (LOADERS)	
Hydraulic Oil Filter.....	H-2703	Hydraulic Oil Filter.....	H-2712	Hydraulic Oil Filter.....	HC-7913
Hydraulic Oil Filter.....	H-2706	FH400 (EXCAVATORS) FIATHTCH 8065.SI.25.ALL006 , 1988-UP		FW350 (LOADERS)	
FH200 (EXCAVATORS) FIATHTCH 8065.SI.25.ALL006 , 1988-UP		Hydraulic Oil Filter.....	H-2703	Hydraulic Oil Filter.....	HC-5508
Hydraulic Oil Filter.....	H-2703	FH450 (EXCAVATORS)		FW450 (LOADERS)	
FH200-3 (EXCAVATORS) IVECO 8065T , 1988-UP		Hydraulic Oil Filter.....	H-2703	Hydraulic Oil Filter.....	HC-5508
Hydraulic Oil Filter.....	H-2703	FR100 (LOADERS) IVECO 8065 , 1991-UP		KH125-3 (CRANES) FIATHTCH EM100	
FH220 (EXCAVATORS) FIATHTCH 8365.SI.11.ALL.010 , 1988-UP		Hydraulic Oil Filter.....	HC-7913		
Hydraulic Oil Filter.....	H-2703				



ENGINE APPLICATION

MODEL/APPLICATION	SAKURA NO	MODEL/APPLICATION	SAKURA NO	MODEL/APPLICATION	SAKURA NO
FIAT HITACHI		FIAT HITACHI		FORD	
KH125-3 (CRANES) FIATHTCH EM100 Hydraulic Oil Filter.....	H-7911	W270 (LOADERS) CUMMINS M11 , 1997-2002 Hydraulic Oil Filter.....	HC-57030	Hydraulic Oil Filter.....	HC-7932
Hydraulic Oil Filter.....	H-2719	W90 (LOADERS) IVECO 8045TE1 Hydraulic Oil Filter.....	HC-57030	205D (AGRICULTURE) NEWHOLLA DIESEL , 1959 Hydraulic Oil Filter.....	HC-7932
KH125-3 (CRANES) FIATHTCH H06CT Hydraulic Oil Filter.....	H-2719	EX40U (EXCAVATORS) ISUZU 4LE1 , 2002-UP Hydraulic Oil Filter.....	H-2712	2310 (TRACTORS) NEWHOLLA 158 CID DIESEL , 1982-UP Hydraulic Oil Filter Transmission...	HC-1902
KH150-2 (CRANES) NISSAN PD604 Hydraulic Oil Filter.....	H-7911	EX455BEH (EXCAVATORS) 2002-UP Hydraulic Oil Filter.....	H-2703	2310 (TRACTORS) NEWHOLLA 158 CID GAS , 1982-UP Hydraulic Oil Filter Transmission...	HC-1902
KH150-3 (CRANES) FIATHTCH BF10L513 Hydraulic Oil Filter.....	H-2719	FB100.2 (LOADERS) NEWHOLLA 5.0 , 2002-UP Hydraulic Oil Filter.....	HC-5506	2600 (TRACTORS) Hydraulic Oil Filter Transmission...	HC-1902
KH150-3 (CRANES) FIATHTCH EM100 Hydraulic Oil Filter.....	H-2719	FB100.2 (LOADERS) NEW HOLLAND 5.0L , 2002 Hydraulic Oil Filter.....	HC-7001	2610 (TRACTORS) TO-1981 Hydraulic Oil Filter Transmission...	HC-1902
KH230-3 (CRANES) FIATHTCH EM100 Hydraulic Oil Filter.....	H-2719	FD255 (CRAWLER DOZERS) FIAT 8465TA , 2002-UP Hydraulic Oil Filter.....	HC-5508	2810 (TRACTORS) Hydraulic Oil Filter Transmission...	HC-1902
KH300-3 (CRANES) FIATHTCH 6RB1 Hydraulic Oil Filter.....	H-2701	W170PL EVOLUTION (LOADERS) 2004 Hydraulic Oil Filter.....	HC-5504	2910 (TRACTORS) 1983-UP Hydraulic Oil Filter Transmission...	HC-1902
Hydraulic Oil Filter.....	H-2719	FODEN		345D (LOADERS) FORD 3CYL , 1992-2000 Hydraulic Oil Filter Transmission...	HC-1902
KH500-3 (CRANES) FIATHTCH 6RBT1 Hydraulic Oil Filter.....	H-2719	4000 SERIES S104, S106, S108 (TRUCKS) CAT 3306 Hydraulic Oil Filter.....	HC-5502	Hydraulic Oil Filter.....	HC-5504
KH850-3 (CRANES) FIATHTCH 6RB1T Hydraulic Oil Filter.....	H-2719	4000 SERIES S104, S106, S108 (TRUCKS) FODEN 3306 ATAAC Hydraulic Oil Filter.....	HC-5502	Hydraulic Oil Filter Full Flow.....	HC-7901
W110 (LOADERS) IVECO 8065T , 1997-UP Hydraulic Oil Filter.....	HC-57030	FORD		3600 (TRACTORS) 1975-UP Hydraulic Oil Filter Transmission...	HC-1902
W170 (LOADERS) CUMMINS 6CT8.3 , 1997-2002 Hydraulic Oil Filter.....	HC-57030	104D (AGRICULTURE) NEWHOLLA DIESEL , 1959 Hydraulic Oil Filter.....	HC-7932	3610 (TRACTORS) 1975-UP Hydraulic Oil Filter Transmission...	HC-1902
Hydraulic Oil Filter.....	HC-76080	105D (AGRICULTURE) NEWHOLLA DIESEL , 1959 Hydraulic Oil Filter.....	HC-7932	3910 (TRACTORS) 1983-UP Hydraulic Oil Filter Transmission...	HC-1902
W230 (LOADERS) CUMMINS Hydraulic Oil Filter.....	HC-76080	106D (AGRICULTURE) NEWHOLLA DIESEL , 1959 Hydraulic Oil Filter.....	HC-7932	404D (AGRICULTURE) NEWHOLLA DIESEL , 1959 Hydraulic Oil Filter.....	HC-7932
Hydraulic Oil Filter.....	HC-57030	1500 (COMBINES) FORD 391 , 1974-1978 Hydraulic Oil Filter.....	H-51170	405D (AGRICULTURE) NEWHOLLA DIESEL , 1959 Hydraulic Oil Filter.....	HC-7932
W230 (LOADERS) CUMMINS 6CTAA8.3 Hydraulic Oil Filter.....	HC-76080	1800D (AGRICULTURE) FORD DIESEL , 1959-1964 Hydraulic Oil Filter.....	HC-7932	4110 (TRACTORS) FORD 201 , 1981-UP Hydraulic Oil Filter Transmission...	HC-1902
W270 (LOADERS) 2005-UP Hydraulic Oil Filter.....	HC-76080	204D (AGRICULTURE) NEWHOLLA DIESEL , 1959		445 (LOADERS) FORD DIESEL Hydraulic Oil Filter Full Flow.....	HC-7901
W270 (LOADERS) CUMMINS QSM11 , 2002-2004 Hydraulic Oil Filter.....	HC-76080			4600 (TRACTORS) FORD 210 DIESEL , 1975-UP Hydraulic Oil Filter Transmission...	HC-1902
W270 (LOADERS) 1998-2001 Hydraulic Oil Filter.....	HC-76080				



ENGINE APPLICATION

MODEL/APPLICATION	SAKURA NO	MODEL/APPLICATION	SAKURA NO	MODEL/APPLICATION	SAKURA NO
FORD					
4600 (TRACTORS) FORD 210 GAS , 1975-UP Hydraulic Oil Filter Transmission...	HC-1902	4600 (TRACTORS) FORD 210 GAS Hydraulic Oil Filter Transmission...	HC-1902	8000 (AGRICULTURE) FORD 401 , 1968-1972 Hydraulic Oil Filter.....	HC-5511
4610 (TRACTORS) FORD 210 GAS Hydraulic Oil Filter Transmission...	HC-1902	6610 (TRACTORS) FORD 268 (S/N: 1981--UP) , 1981-UP Hydraulic Oil Filter Transmission...	HC-1902	8000 (AGRICULTURE) FORD 401 Hydraulic Oil Filter.....	HC-5511
500D (AGRICULTURE) FORD DIESEL , 1959-1964 Hydraulic Oil Filter.....	HC-7932	6640 (TRACTORS) NEWHOLLA 304 CID , 1991-UP Hydraulic Oil Filter.....	HC-76080	8000 (AGRICULTURE) FORD DIESEL , 1959-1964 Hydraulic Oil Filter.....	HC-7932
501D (TRACTORS) FORD DIESEL Hydraulic Oil Filter.....	HC-1903	6700 (TRACTORS) FORD 256 Hydraulic Oil Filter.....	HC-1905	8260 (TRACTORS) 1991-UP Hydraulic Oil Filter.....	HC-5511
535 (BACKHOES) Hydraulic Oil Filter.....	H-5001	6640 (AGRICULTURE) NEWHOLLA 304 CID , 1991 Hydraulic Oil Filter.....	HC-1905	8260 (AGRICULTURE) 1991 Hydraulic Oil Filter.....	HC-5511
Hydraulic Oil Filter Full Flow.....	HC-7901	6700 (TRACTORS) FORD 256 Hydraulic Oil Filter Transmission...	HC-1902	8630 (AGRICULTURE) 8630 Hydraulic Oil Filter Transmission...	HC-1901
555C (LOADERS) FORD DIESEL Hydraulic Oil Filter.....	H-5001	6700 (TRACTORS) FORD 268 Hydraulic Oil Filter Transmission...	HC-1902	8630 (TRACTORS) Hydraulic Oil Filter Transmission...	HC-1902
Hydraulic Oil Filter.....	HC-5506	6710 (TRACTORS) FORD 256 DIESEL , 1981-UP Hydraulic Oil Filter Transmission...	HC-1902	8700 (TRACTORS) NEWHOLLA 401D Hydraulic Oil Filter Transmission...	HC-1902
Hydraulic Oil Filter Full Flow.....	HC-7901	700D (AGRICULTURE) FORD DIESEL , 1959-1964 Hydraulic Oil Filter.....	HC-7932	8830 (TRACTORS) 1990-UP Hydraulic Oil Filter Transmission...	HC-1902
5600 (TRACTORS) FORD 201 DIESEL Hydraulic Oil Filter Transmission...	HC-1902	713 (BACKHOES) Hydraulic Oil Filter.....	HC-1903	9200 (AGRICULTURE) Hydraulic Oil Filter.....	HC-5511
5600 (TRACTORS) FORD 233 DIESEL Hydraulic Oil Filter Transmission...	HC-1902	7500 (TRACTORS) Hydraulic Oil Filter Transmission....	H-5109	9200 (TRACTORS) FORD DIESEL Hydraulic Oil Filter.....	HC-5511
5610 (TRACTORS) FORD 256 , 1981-UP Hydraulic Oil Filter Transmission...	HC-1902	755 (LOADERS) FORD DIESEL Hydraulic Oil Filter Transmission....	H-5109	9260 (AGRICULTURE) Hydraulic Oil Filter.....	HC-5511
575D (LOADERS) Hydraulic Oil Filter Full Flow.....	HC-7901	755A (LOADERS) FORD DIESEL Hydraulic Oil Filter Transmission....	H-5109	9600 (AGRICULTURE) Hydraulic Oil Filter.....	HC-5511
6000 (TRACTORS) Hydraulic Oil Filter.....	HC-1903	7600 (TRACTORS) 1975-1981 Hydraulic Oil Filter Transmission...	HC-1902	F650 SUPER DUTY (PASSENGER CARS) CAT C7 Hydraulic Oil Filter Transmission..	H-8537-S
600D (AGRICULTURE) FORD DIESEL , 1959-1964 Hydraulic Oil Filter.....	HC-7932	7610 (TRACTORS) 1981-1991 Hydraulic Oil Filter Transmission...	HC-1902	Hydraulic Oil Filter Transmission....	H-8538
6500 (TRACTORS) Hydraulic Oil Filter Transmission....	H-5109	7700 (TRACTORS) 1975-1981 Hydraulic Oil Filter Transmission...	HC-1902	F650 SUPER DUTY (PASSENGER CARS) CUMMINS ISB5.9 Hydraulic Oil Filter Transmission..	H-8537-S
655 (LOADERS) Hydraulic Oil Filter Full Flow.....	HC-7901	7710 (TRACTORS) 1981-1991 Hydraulic Oil Filter Transmission...	HC-1902	Hydraulic Oil Filter Transmission....	H-8538
655C (LOADERS) Hydraulic Oil Filter Full Flow.....	HC-7901	7700 (TRACTORS) 1975-1981 Hydraulic Oil Filter Transmission...	HC-1902	F750 SUPER DUTY (PASSENGER CARS) CAT 3126B Hydraulic Oil Filter Transmission..	H-8537-S
Hydraulic Oil Filter.....	H-5001	7710 (TRACTORS) 1981-1991 Hydraulic Oil Filter Transmission...	HC-1902		
6600 (TRACTORS) FORD 256 DIESEL , 1975-1980					



ENGINE APPLICATION

MODEL/APPLICATION	SAKURA NO	MODEL/APPLICATION	SAKURA NO	MODEL/APPLICATION	SAKURA NO
FORD		FREIGHTLINER		FREIGHTLINER	
F750 SUPER DUTY (PASSENGER CARS) CAT 3126B Hydraulic Oil Filter Transmission....	H-8538	ARGOSY (TRUCKS) w/Cummins ISX Eng. Hydraulic Oil Filter Power steering..	H-55420	Century C112 (TRUCKS) w/Cat C12 Eng. (Australia) Hydraulic Oil Filter Power steering..	H-55420
F750 SUPER DUTY (PASSENGER CARS) CAT C7 Hydraulic Oil Filter Transmission..	H-8537-S	ARGOSY (TRUCKS) w/Detroit Diesel Series 60 Eng. (Australia) Hydraulic Oil Filter Power steering..	H-55420	Century C120 (TRUCKS) w/Cat C15 Eng. (Australia) Hydraulic Oil Filter Power steering..	H-55420
Hydraulic Oil Filter Transmission....	H-8538	ARGOSY (TRUCKS) w/Detroit Diesel Series 60 Eng. (North America) Hydraulic Oil Filter Power steering..	H-55420	Century C120 (TRUCKS) w/Cummins ISX Eng. Hydraulic Oil Filter Power steering..	H-55420
F750 SUPER DUTY (PASSENGER CARS) CUMMINS ISB5.9 Hydraulic Oil Filter Transmission..	H-8537-S	BUSINESS CLASS M2 (TRUCKS) w/Cummins ISB (5.9L) Eng. , 5900 Hydraulic Oil Filter Power steering..	H-55420	Century CST112 (TRUCKS) w/Cat C12 Eng Hydraulic Oil Filter Power steering..	H-55420
Hydraulic Oil Filter Transmission....	H-8538	BUSINESS CLASS M2 (TRUCKS) w/Cummins ISB (6.7L) Eng. , 6700 Hydraulic Oil Filter Power steering..	H-55420	Century CST120 (TRUCKS) w/Cummins N14 Eng Hydraulic Oil Filter Power steering..	H-55420
F750 SUPER DUTY (PASSENGER CARS) CUMMINS ISB6.7 Hydraulic Oil Filter Transmission..	H-8537-S	BUSINESS CLASS M2 (TRUCKS) w/Cat C11 Eng. Hydraulic Oil Filter Power steering..	H-55420	Century CST120 (TRUCKS) w/Cummins ISX Eng. Hydraulic Oil Filter Power steering..	H-55420
Hydraulic Oil Filter Transmission....	H-8538	BUSINESS CLASS M2 (TRUCKS) w/Mercedes-Benz MBE460 Eng. Hydraulic Oil Filter Power steering..	H-55420	Classic (TRUCKS) w/Cat C15 Eng Hydraulic Oil Filter Power steering..	H-55420
FW40 (TRACTORS) CUMMINS V-903 Hydraulic Oil Filter.....	HC-5511	Business Class M2e Hybrid (TRUCKS) w/Cummins ISB Eng. Hydraulic Oil Filter Power steering..	H-55420	Classic (TRUCKS) w/Detroit Diesel Series 60 Eng. Hydraulic Oil Filter Power steering..	H-55420
H41 (EXCAVATORS) FORD 401DF Hydraulic Oil Filter.....	HC-1903	CENTURY CLASS S/T (TRUCKS) w/Cat 3406E Eng Hydraulic Oil Filter Power steering..	H-55420	Classic XL (TRUCKS) w/Cat C15 Eng Hydraulic Oil Filter Power steering..	H-55420
TW24 (TRACTORS) Hydraulic Oil Filter.....	HC-7938	CENTURY CLASS S/T (TRUCKS) w/Cat C12 Eng Hydraulic Oil Filter Power steering..	H-55420	Classic XL (TRUCKS) w/Detroit Diesel Series 60 Eng. Hydraulic Oil Filter Power steering..	H-55420
TX30 (HARVESTERS) FORD 666HT , 1991 Hydraulic Oil Filter.....	HC-7906	CENTURY CLASS S/T (TRUCKS) w/Cummins M11 (10.8L) Eng Hydraulic Oil Filter Power steering..	H-55420	COLUMBIA (TRUCKS) w/Cat C13 Eng Hydraulic Oil Filter Power steering..	H-55420
TX34 (HARVESTERS) FORD 678HT , 1991 Hydraulic Oil Filter.....	HC-7906	CENTURY CLASS S/T (TRUCKS) w/Cat C15 Eng Hydraulic Oil Filter Power steering..	H-55420	COLUMBIA (TRUCKS) w/Cat C12 Eng Hydraulic Oil Filter Power steering..	H-55420
TX34 (HARVESTERS) FORD 678HTA , 1991 Hydraulic Oil Filter.....	HC-7906	CENTURY CLASS S/T (TRUCKS) w/Cummins N14 (14.0L) Eng. Hydraulic Oil Filter Power steering..	H-55420	COLUMBIA (TRUCKS) w/Cummins ISM (10.8L) Eng Hydraulic Oil Filter Power steering..	H-55420
FREEMAN		CENTURY CLASS S/T (TRUCKS) w/Cummins ISX Eng. Hydraulic Oil Filter Power steering..	H-55420	COLUMBIA (TRUCKS) w/Cummins ISX Eng. Hydraulic Oil Filter Power steering..	H-55420
200T (HAY BALERS) Hydraulic Oil Filter.....	H-51170	CENTURY CLASS S/T (TRUCKS) w/Detroit Diesel Series 60 (11.1L) & (12.7L) Eng. Hydraulic Oil Filter Power steering..	H-55420	COLUMBIA (TRUCKS) w/Cummins N14 (14.0L) Eng. Hydraulic Oil Filter Power steering..	H-55420
FREIGHTLINER		CENTURY CLASS S/T (TRUCKS) w/Mercedes-Benz MBE4000 Eng. Hydraulic Oil Filter Power steering..	H-55420		
ARGOSY (TRUCKS) w/Cat C15 Eng Hydraulic Oil Filter Power steering..	H-55420				
ARGOSY (TRUCKS) w/Cat C12 Eng. (New Zealand) Hydraulic Oil Filter Power steering..	H-55420				
ARGOSY (TRUCKS) w/Cat C12 Eng. (North America) Hydraulic Oil Filter Power steering..	H-55420				
ARGOSY (TRUCKS) w/Cummins ISM (10.8L) Eng Hydraulic Oil Filter Power steering..	H-55420				



ENGINE APPLICATION

MODEL/APPLICATION	SAKURA NO	MODEL/APPLICATION	SAKURA NO	MODEL/APPLICATION	SAKURA NO
FREIGHTLINER		FREIGHTLINER		FREIGHTLINER	
COLUMBIA (TRUCKS) w/Detroit Diesel Series 60 Eng. Hydraulic Oil Filter Power steering.	H-55420	FL-50 (TRUCKS) w/Cat C7 (7.2L) Eng. , 7200 Hydraulic Oil Filter Power steering.	H-55420	FLC (TRUCKS) w/Cummins M11 Eng. Hydraulic Oil Filter Power steering.	H-55420
COLUMBIA (TRUCKS) w/Mercedes-Benz MBE4000 Eng. Hydraulic Oil Filter Power steering.	H-55420	FL60 (TRUCKS) w/Cummins ISB (5.9L) Eng. , 5900 Hydraulic Oil Filter Power steering.	H-55420	FLC (TRUCKS) w/Detroit Diesel Series 60 Eng. Hydraulic Oil Filter Power steering.	H-55420
COLUMBIA CL112 (TRUCKS) w/Detroit Diesel Series 60 Eng. Hydraulic Oil Filter Power steering.	H-55420	FL60 (TRUCKS) w/Mercedes-Benz MBE906 (6.4L) Eng. , 6400 Hydraulic Oil Filter Power steering.	H-55420	FLC112 (TRUCKS) w/Cat C12 Eng Hydraulic Oil Filter Power steering.	H-55420
Coronado (TRUCKS) w/Cat C15, C16 Eng. Hydraulic Oil Filter Power steering.	H-55420	FL60 (TRUCKS) w/Cat 3126 (7.2L) Eng. , 7200 Hydraulic Oil Filter Power steering.	H-55420	FLD (TRUCKS) w/Cat C13 Eng Hydraulic Oil Filter Power steering.	H-55420
Coronado (TRUCKS) w/Detroit Diesel Series 60 Eng. Hydraulic Oil Filter Power steering.	H-55420	FL60 (TRUCKS) w/Cat C7 (7.2L) Eng. , 7200 Hydraulic Oil Filter Power steering.	H-55420	FLD (TRUCKS) w/Cat C12 Eng Hydraulic Oil Filter Power steering.	H-55420
Coronado CC132 (TRUCKS) w/Cat C15 Eng Hydraulic Oil Filter Power steering.	H-55420	FL60 (TRUCKS) w/Mercedes-Benz OM906 Eng. Hydraulic Oil Filter Power steering.	H-55420	FLD (TRUCKS) w/Cat C15 Eng Hydraulic Oil Filter Power steering.	H-55420
Coronado CC132 (TRUCKS) w/Detroit Diesel Series 60 Eng. Hydraulic Oil Filter Power steering.	H-55420	FL-70 (TRUCKS) w/Mercedes-Benz MBE906 (6.4L) Eng. , 6400 Hydraulic Oil Filter Power steering.	H-55420	FLD (TRUCKS) w/Cat C10 Eng. Hydraulic Oil Filter Power steering.	H-55420
CST112 (TRUCKS) w/Mercedes-Benz MBE4000 Eng. Hydraulic Oil Filter Power steering.	H-55420	FL-70 (TRUCKS) w/Cat C7 (7.2L), 3126 (7.2L) Eng. , 7200 Hydraulic Oil Filter Power steering.	H-55420	FLD (TRUCKS) w/Cat C9 Eng. Hydraulic Oil Filter Power steering.	H-55420
CST120 (TRUCKS) w/Detroit Diesel Series 60 Eng. Hydraulic Oil Filter Power steering.	H-55420	FL-70 (TRUCKS) w/Cummins C8.3G (8.3L) CNG, LPG Eng. , 8300 Hydraulic Oil Filter Power steering.	H-55420	FLD (TRUCKS) w/Cummins ISM Eng Hydraulic Oil Filter Power steering.	H-55420
CST120 (TRUCKS) w/Mercedes-Benz MBE4000 Eng. Hydraulic Oil Filter Power steering.	H-55420	FL-70 (TRUCKS) w/Cummins ISC (8.3L) Eng. , 8300 Hydraulic Oil Filter Power steering.	H-55420	FLD (TRUCKS) w/Cummins ISX, Signature 600 Eng. Hydraulic Oil Filter Power steering.	H-55420
FL-106 (TRUCKS) w/Detroit Diesel Series 50 (8.5L) Eng. , 8500 Hydraulic Oil Filter Power steering.	H-55420	FL-70 (TRUCKS) w/Detroit Diesel Series 60 Eng. Hydraulic Oil Filter Power steering.	H-55420	FLD (TRUCKS) w/Detroit Diesel Series 60 Eng. Hydraulic Oil Filter Power steering.	H-55420
FL112 (TRUCKS) w/Cat C12 Eng Hydraulic Oil Filter Power steering.	H-55420	FL-80 (TRUCKS) w/Cat 3126 Eng. Hydraulic Oil Filter Power steering.	H-55420	FLD (TRUCKS) w/Mercedes-Benz MBE4000 Eng. Hydraulic Oil Filter Power steering.	H-55420
FL112 (TRUCKS) w/Cat C10 Eng. Hydraulic Oil Filter Power steering.	H-55420	FL-80 (TRUCKS) w/Cat C7 Eng. Hydraulic Oil Filter Power steering.	H-55420	FLD (TRUCKS) w/Mercedes-Benz MBE900 Eng. Hydraulic Oil Filter Power steering.	H-55420
FL112 (TRUCKS) w/Cummins ISM (10.8L) Eng. (North America) Hydraulic Oil Filter Power steering.	H-55420	FL-80 (TRUCKS) w/Mercedes-Benz MBE900 Eng. Hydraulic Oil Filter Power steering.	H-55420	FUCHS	
FL112 (TRUCKS) w/Cummins ISM Eng. (Australia) Hydraulic Oil Filter Power steering.	H-55420	FLC (TRUCKS) w/Cat C12 Eng Hydraulic Oil Filter Power steering.	H-55420	713M (EXCAVATORS) DEUTZ F3L912W Hydraulic Oil Filter..... H-6301	H-6301
FL112 (TRUCKS) w/Mercedes-Benz MBE4000 Eng. Hydraulic Oil Filter Power steering.	H-55420	FLC (TRUCKS) w/Cat 3406 Eng. Hydraulic Oil Filter Power steering.	H-55420	714 (EXCAVATORS) DEUTZ F6L912W Hydraulic Oil Filter..... H-6301	H-6301
FL-50 (TRUCKS) w/Mercedes-Benz MBE906 (6.4L) Eng. , 6400 Hydraulic Oil Filter Power steering.	H-55420	FLC (TRUCKS) w/Cummins N14 Eng Hydraulic Oil Filter Power steering.	H-55420	FULLER	
				R-1750 (TRANSMISSIONS) Hydraulic Oil Filter Transmission... H-65030	H-65030



ENGINE APPLICATION

MODEL/APPLICATION	SAKURA NO	MODEL/APPLICATION	SAKURA NO	MODEL/APPLICATION	SAKURA NO
FULLER		GEHL		GEHL	
RM-1750 (TRANSMISSIONS)		Hydraulic Oil Filter.....	HC-5511	5640E (LOADERS) DEUTZ F4M2011	
Hydraulic Oil Filter Transmission...	H-65030	3200 (CONSTRUCTION & MINING) GEHL L.P.G.		Hydraulic Oil Filter.....	HC-7927
FURUKAWA		Hydraulic Oil Filter.....	HC-5511	6635 (INDUSTRIAL EQUIPMENTS, ENGINES)	
640ELS (LOADERS) FURUKAWA F659TA , 1990-UP		Hydraulic Oil Filter.....	HC-5511	Hydraulic Oil Filter.....	HC-5504
Hydraulic Oil Filter.....	H-62040	3635 DXT (LOADERS) DEUTZ BF3M1011		6640E (LOADERS) DEUTZ BF4M2011	
725ELS (LOADERS) FURUKAWA F439T , 1995-UP		Hydraulic Oil Filter.....	HC-7927	Hydraulic Oil Filter.....	HC-7927
Hydraulic Oil Filter.....	H-76050	3635 SXT (LOADERS) DEUTZ BF4M1011		7800 TURBO (LOADERS) YANMAR 4TNE106	
735ELS (LOADERS) FURUKAWA F659T , 1995-UP		Hydraulic Oil Filter.....	HC-7927	Hydraulic Oil Filter.....	HC-5506
Hydraulic Oil Filter.....	H-76050	3640E (LOADERS) YANMAR 3TNV88		HL2600 (LOADERS) ONAN (S/N: NHC-UP)	
FL120 (LOADERS) HINO		Hydraulic Oil Filter.....	HC-7927	Hydraulic Oil Filter.....	HC-1903
Hydraulic Oil Filter.....	H-5625	4240E (LOADERS) YANMAR 4TNV88		HL4500 (LOADERS) FORD	
FL150-1 (LOADERS)		Hydraulic Oil Filter.....	HC-7927	Hydraulic Oil Filter.....	HC-5511
Hydraulic Oil Filter.....	H-5625	4300 (LOADERS) WISCONSIN VH-4D		HYDROCAT HL-3030 (HARVESTERS) WISCONSIN VH-4D	
GALION		Hydraulic Oil Filter.....	H-51170	Hydraulic Oil Filter.....	HC-1903
830B (GRADERS) IHC D359T		4635SX (LOADERS) DEUTZ F3M1011		R55-19 (LOADERS) DEUTZ TD2009	
Hydraulic Oil Filter.....	HC-76080	Hydraulic Oil Filter.....	HC-7927	Hydraulic Oil Filter.....	HC-7927
850B (GRADERS) IHC D505T		4635SX (LOADERS) DEUTZ BF3M1011		SL3610 (LOADERS) ISUZU QD27	
Hydraulic Oil Filter.....	HC-76080	Hydraulic Oil Filter.....	HC-7927	Hydraulic Oil Filter Full Flow.....	HC-7935
JV100-1+D1515 (ROLLERS) S/N: 10011-UP		4640E (LOADERS) DEUTZ F3M2011		SL3610 (LOADERS) ISUZU QT35	
Hydraulic Oil Filter.....	H-5611	Hydraulic Oil Filter.....	HC-7927	Hydraulic Oil Filter Full Flow.....	HC-7935
GEHL		4640E (LOADERS) DEUTZ BF3M2011		SL4525 (LOADERS) FORD	
1438 (INDUSTRIAL EQUIPMENTS, ENGINES)		Hydraulic Oil Filter.....	HC-7927	Hydraulic Oil Filter.....	HC-7927
Hydraulic Oil Filter.....	HC-5504	4700 (LOADERS) FORD 1600 CC		SL4610 (LOADERS) GEHL 104-19	
1439 (PAVING EQUIPMENT) ISUZU		Hydraulic Oil Filter.....	H-51170	Hydraulic Oil Filter.....	HC-7927
Hydraulic Oil Filter.....	HC-7927	4835XST (INDUSTRIAL EQUIPMENTS, ENGINES)		SL4610 (LOADERS) PERKINS	
1448 (INDUSTRIAL EQUIPMENTS, ENGINES)		Hydraulic Oil Filter.....	HC-5504	Hydraulic Oil Filter.....	HC-5504
Hydraulic Oil Filter.....	HC-5504	4840E (LOADERS) DEUTZ F4M2011		SL4625DX (LOADERS) KUBOTA V2203-B	
1648 (PAVING EQUIPMENT) ISUZU		Hydraulic Oil Filter.....	HC-7927	Hydraulic Oil Filter.....	HC-7927
Hydraulic Oil Filter.....	HC-7927	5240E (LOADERS) DEUTZ TD2009		SL4835DX (LOADERS) DEUTZ BF3M1011	
1649 (INDUSTRIAL EQUIPMENTS, ENGINES)		Hydraulic Oil Filter.....	HC-7927	Hydraulic Oil Filter.....	HC-7927
Hydraulic Oil Filter.....	HC-5504	5625 (LOADERS) PERKINS 4.154		SL5620 (LOADERS) PERKINS 4.154	
3000 (CONSTRUCTION & MINING) ONAN ONAN		Hydraulic Oil Filter.....	HC-5504	Hydraulic Oil Filter.....	HC-7927
Hydraulic Oil Filter.....	HC-5511	5640E (LOADERS) DEUTZ BF4M2011		SL5625DX (LOADERS) PERKINS 4.154	
3000 (LOADERS) ONAN		Hydraulic Oil Filter.....	HC-7927	Hydraulic Oil Filter.....	HC-5504



ENGINE APPLICATION

MODEL/APPLICATION	SAKURA NO	MODEL/APPLICATION	SAKURA NO	MODEL/APPLICATION	SAKURA NO
GEHL		GENIE		GRADALL	
SL5625DX (LOADERS) PERKINS 4.154 Hydraulic Oil Filter.....	HC-7927	Hydraulic Oil Filter.....	HC-6802	300-3 (INDUSTRIAL EQUIPMENTS, ENGINES)	
SL5635DX (LOADERS) DEUTZ BF4M1011F Hydraulic Oil Filter.....	HC-7927	Z60/34 RT (FORKLIFTS)		Hydraulic Oil Filter.....	HC-6802
SL5635DX (LOADERS) DEUTZ F4M1011F Hydraulic Oil Filter.....	HC-7927	Hydraulic Oil Filter.....	HC-7939	GREGOIRE	
SL6620 (LOADERS) PERKINS 4.154 Hydraulic Oil Filter.....	HC-7927	GMC		6130 (AGRICULTURE)	
SL6625SX (LOADERS) PERKINS Hydraulic Oil Filter.....	HC-7927	Topkick C5500 (LIGHT COMMERCIALS) GMC V8 400 6.6L TURBO DSL DURAMAX Hydraulic Oil Filter Transmission... H-8537-S		Hydraulic Oil Filter.....	HC-7906
SL6635SX (LOADERS) DEUTZ BF4M1011F Hydraulic Oil Filter.....	HC-7927	Hydraulic Oil Filter Transmission.... H-8538		G130 (HARVESTERS) DEUTZ	
SL7600 (LOADERS) YANMAR 4TNE106 Hydraulic Oil Filter.....	HC-5506	Topkick C5500 (LIGHT COMMERCIALS) GMC V8 496 8.1L VORTEC Hydraulic Oil Filter Transmission... H-8537-S		Hydraulic Oil Filter.....	HC-7906
SL7600 (LOADERS) YANMAR 4TNE106T Hydraulic Oil Filter.....	HC-5506	Hydraulic Oil Filter Transmission.... H-8538		GRESEN	
SP-188 (HARVESTERS) GMC Hydraulic Oil Filter Transmission... H-65030		TOPKICK C6500 (LIGHT COMMERCIALS) CAT C7 Hydraulic Oil Filter Transmission.... H-8538		F-200 SERIES (HYDRAULIC SYSTEMS)	
V270 (LOADERS) YANMAR Hydraulic Oil Filter.....	HC-7927	Hydraulic Oil Filter Transmission... H-8537-S		Hydraulic Oil Filter.....	H-51170
GENIE		TOPKICK C6500 (LIGHT COMMERCIALS) CAT 3126E Hydraulic Oil Filter.....	HC-69031	F-400 (HYDRAULIC SYSTEMS)	
G4390 (FORKLIFTS) DEUTZ F4L1011 Hydraulic Oil Filter.....	HC-62010	TOPKICK C6500 (LIGHT COMMERCIALS) GMC V8 496 8.1L TURBO VORTEC Hydraulic Oil Filter Transmission.... H-8538		Hydraulic Oil Filter.....	H-51170
G5390 (FORKLIFTS) DEUTZ F4L1011 Hydraulic Oil Filter.....	HC-62010	Hydraulic Oil Filter Transmission... H-8537-S		LF-200 SERIES (HYDRAULIC SYSTEMS)	
S125 (FORKLIFTS) DEUTZ F4L913 Hydraulic Oil Filter.....	HC-62010	TOPKICK C6500 (LIGHT COMMERCIALS) ISUZU 7.8L DURAMAX Hydraulic Oil Filter Transmission.... H-8538		Hydraulic Oil Filter.....	H-51170
S85 (FORKLIFTS) DEUTZ F4L1011 Hydraulic Oil Filter.....	HC-69031	TOPKICK C7500 (LIGHT COMMERCIALS) GMC V8 496 8.1L MFI Hydraulic Oil Filter Transmission... H-8537-S		GROVE	
S85 (FORKLIFTS) DEUTZ F4L913 Hydraulic Oil Filter.....	HC-62010	Hydraulic Oil Filter Transmission.... H-8538		1012 (CRANES) DETROITD 4-53	
Z34/22 IC (FORKLIFTS) KUBOTA D905E Hydraulic Oil Filter.....	HC-62010	TOPKICK C7500 (LIGHT COMMERCIALS) GMC V8 496 8.1L TURBO VORTEC Hydraulic Oil Filter Transmission... H-8537-S		Hydraulic Oil Filter Transmission... H-65030	
Z45/25 DC (FORKLIFTS)		Hydraulic Oil Filter Transmission.... H-8538		1012B (CRANES) GMC 4-53	
		TOPKICK C8500 (LIGHT COMMERCIALS) CAT C7 Hydraulic Oil Filter Transmission.... H-8538		Hydraulic Oil Filter Transmission... H-65030	
		Hydraulic Oil Filter Transmission... H-8537-S		2535 (CRANES) CAT 320B	
		TOPKICK C8500 (LIGHT COMMERCIALS) GMC V8 496 8.1L VORTEC Hydraulic Oil Filter Transmission... H-8537-S		Hydraulic Oil Filter Transmission... H-65030	
		Hydraulic Oil Filter Transmission.... H-8538		2535 (CRANES) CUMMINS V-555	
		TOPKICK C8500 (LIGHT COMMERCIALS) ISUZU 7.8L DURAMAX Hydraulic Oil Filter Transmission... H-8537-S		Hydraulic Oil Filter Transmission... H-65030	
		Hydraulic Oil Filter Transmission.... H-8538		2535 (CRANES) DETROITD 6V-53	
		TOPKICK C8500 (LIGHT COMMERCIALS) ISUZU 7.8L DURAMAX Hydraulic Oil Filter Transmission... H-8537-S		Hydraulic Oil Filter Transmission... H-65030	
		Hydraulic Oil Filter Transmission.... H-8538		AMZ131XT (CRANES) CUMMINS 4BT3.9 , 1997-UP	
		TOPKICK C8500 (LIGHT COMMERCIALS) ISUZU 7.8L DURAMAX Hydraulic Oil Filter Transmission... H-8537-S		Hydraulic Oil Filter.....	H-7985
		Hydraulic Oil Filter Transmission.... H-8538		HL150T (CRANES) DETROITD 6V-92	
		TOPKICK C8500 (LIGHT COMMERCIALS) GMC V8 496 8.1L VORTEC Hydraulic Oil Filter Transmission... H-8537-S		Hydraulic Oil Filter Transmission... H-65030	
		Hydraulic Oil Filter Transmission.... H-8538		MZ116 (CRANES) WISCONSIN	
		TOPKICK C8500 (LIGHT COMMERCIALS) ISUZU 7.8L DURAMAX Hydraulic Oil Filter Transmission... H-8537-S		Hydraulic Oil Filter Full Flow.....	HC-7935
		Hydraulic Oil Filter Transmission.... H-8538		MZ48B (CRANES) NISSAN A15	
		TOPKICK C8500 (LIGHT COMMERCIALS) ISUZU 7.8L DURAMAX Hydraulic Oil Filter Transmission... H-8537-S		Hydraulic Oil Filter.....	HC-6901
		Hydraulic Oil Filter Transmission.... H-8538		PELICAN 1100 (CRANES)	



ENGINE APPLICATION

MODEL/APPLICATION	SAKURA NO	MODEL/APPLICATION	SAKURA NO	MODEL/APPLICATION	SAKURA NO
GROVE		GROVE		HAMM (WIRTGENGROUP)	
PELICAN 1100 (CRANES) Hydraulic Oil Filter..... HC-7939		RT740 (CRANES) DETROITD 6V-53 Hydraulic Oil Filter Transmission... H-65030		2420 (ROLLERS) KHD F6L912 Hydraulic Oil Filter..... HC-6801	
RT48 (CRANES) FORD 6 CYL 300 Hydraulic Oil Filter Transmission... H-65030		RT755 (CRANES) GMC 6V-53N Hydraulic Oil Filter Transmission... H-65030		2620 (ROLLERS) Hydraulic Oil Filter..... HC-6801	
RT49 (CRANES) GMC 4-53N Hydraulic Oil Filter Transmission... H-65030		RT865 (CRANES) CAT 3306 Hydraulic Oil Filter Transmission... H-65030		3012DS (ROLLERS) KHD BF4L913 , 1994-UP Hydraulic Oil Filter..... HC-6802	
RT500 (CRANES) CUMMINS V-378 Hydraulic Oil Filter Transmission... H-65030		RT865 (CRANES) DETROITD 6-71 Hydraulic Oil Filter Transmission... H-65030		4011D (ROLLERS) KHD BF6M1012 , 1991-UP Hydraulic Oil Filter..... HC-6801	
RT500 (CRANES) DETROITD 4-53 Hydraulic Oil Filter Transmission... H-65030		RT9130E (CRANES) 2009-UP Hydraulic Oil Filter..... HC-5503		4011D (ROLLERS) KHD F6L912 , 1991-UP Hydraulic Oil Filter..... HC-6801	
RT500 (CRANES) DEUTZ F6L912 Hydraulic Oil Filter Transmission... H-65030		RT980 (CRANES) CAT 3306 Hydraulic Oil Filter Transmission... H-65030		DV8 (ROLLERS) Hydraulic Oil Filter..... HC-6801	
RT522 (CRANES) DETROITD 4-53 Hydraulic Oil Filter Transmission... H-65030		RT980 (CRANES) CUMMINS NT-855 SERIES NTC- 250 Hydraulic Oil Filter Transmission... H-65030		RACO 350 (ROLLERS) Hydraulic Oil Filter..... HC-7906	
RT528B (CRANES) CUMMINS 6BT5.9 Hydraulic Oil Filter Transmission... H-65030		RT980 (CRANES) DETROITD 6-71T Hydraulic Oil Filter Transmission... H-65030		HANCOCK	
RT58A (CRANES) CUMMINS Hydraulic Oil Filter Transmission... H-65030		GUANGXI LIUGONG MACHINERY		11E4 (SCRAPERS) Hydraulic Oil Filter..... H-5405	
RT58A (CRANES) DETROITD 4-53N Hydraulic Oil Filter Transmission... H-65030		842 (LOADERS) CUMMINS 6B5.9 , 2005-UP Hydraulic Oil Filter Transmission... HC-2701		14E4 (SCRAPERS) Hydraulic Oil Filter..... H-5405	
RT58A (CRANES) DEUTZ F6L912 Hydraulic Oil Filter Transmission... H-65030		888 (LOADERS) CUMMINS , 2005-UP Hydraulic Oil Filter..... HC-6802		292 (SCRAPERS) DETROITD 4-71 Hydraulic Oil Filter..... H-5405	
RT59 (CRANES) GMC 4-53N Hydraulic Oil Filter Transmission... H-65030		GULDNER		292C (SCRAPERS) Hydraulic Oil Filter..... H-51170	
RT625 (CRANES) CAT 3208 Hydraulic Oil Filter Transmission... H-65030		H35 (FORKLIFTS) DEUTZ F4/6L912 Hydraulic Oil Filter..... HC-62020		Hydraulic Oil Filter..... H-5405	
RT625 (CRANES) DETROITD 4-53T Hydraulic Oil Filter Transmission... H-65030		GURIA		294 (SCRAPERS) DETROITD 4-71 Hydraulic Oil Filter..... H-51170	
RT630B (CRANES) CUMMINS 6BT5.9 Hydraulic Oil Filter..... H-57030		516 (BACKHOE LOADERS) John Deere Hydraulic Oil Filter..... H-85110		Hydraulic Oil Filter..... H-5405	
RT655 (CRANES) GMC 8V-71 Hydraulic Oil Filter Transmission... H-65030		HALLA		BL60 (BACKHOE LOADERS) CONTINEL F-244 Hydraulic Oil Filter..... H-5405	
RT740 (CRANES) CAT 3208 Hydraulic Oil Filter Transmission... H-65030		HA290 (LOADERS) CUMMINS 6CT8.3 Hydraulic Oil Filter Transmission... HC-2701		Hydraulic Oil Filter..... H-7983	
		HAMM (WIRTGENGROUP)		BL700 (BACKHOE LOADERS) CONTINEL F-224 Hydraulic Oil Filter..... H-79411	
		2320D (ROLLERS) DEUTZ F4L912 (S/N: 39890-UP) , 1994-UP Hydraulic Oil Filter..... HC-6801		BL700 (BACKHOE LOADERS) DETROITD 3-53 Hydraulic Oil Filter..... H-79411	
		2420D (ROLLERS) KHD BF6M1012E , 1994-UP Hydraulic Oil Filter..... HC-6801			



ENGINE APPLICATION

MODEL/APPLICATION	SAKURA NO	MODEL/APPLICATION	SAKURA NO	MODEL/APPLICATION	SAKURA NO
HANOMAG-HENSCHEL		HANOMAG-HENSCHEL		HESSTON	
44D (CONSTRUCTION EQUIPMENTS)		K7B (DOZERS)		140-90 (EQUIPMENT)	
Hydraulic Oil Filter.....	HC-6802	Hydraulic Oil Filter.....	H-6301	Hydraulic Oil Filter.....	HC-45110
Hydraulic Oil Filter.....	H-6301				
55D (LOADERS) HANOMAGH D963B		K8 (DOZERS)		1580 (EQUIPMENT)	
Hydraulic Oil Filter.....	HC-6802	Hydraulic Oil Filter.....	H-6301	Hydraulic Oil Filter.....	HC-45110
Hydraulic Oil Filter.....	H-6301				
B11C (CONSTRUCTION EQUIPMENTS)		HANIX		4000 (FORAGE HARVESTERS) CAT 3160	
Hydraulic Oil Filter.....	H-6301	H26B (LOADERS)		Hydraulic Oil Filter.....	H-51170
		Hydraulic Oil Filter.....	HC-5602		
B16 (CONSTRUCTION EQUIPMENTS)		HATRA		466 (EQUIPMENT)	
Hydraulic Oil Filter.....	H-6301	H700L (LOADERS)		Hydraulic Oil Filter.....	HC-45110
		Hydraulic Oil Filter.....	HC-1822		
B18C (CONSTRUCTION EQUIPMENTS)		Hydraulic Oil Filter.....	H-6301	55-66 (EQUIPMENT)	
Hydraulic Oil Filter.....	H-6301	M40 (LOADERS)		Hydraulic Oil Filter.....	HC-45110
		Hydraulic Oil Filter.....	H-6301		
B30C (CONSTRUCTION EQUIPMENTS)		M80 (LOADERS) DEUTZ F6L912		60-90 (EQUIPMENT)	
Hydraulic Oil Filter.....	H-6301	Hydraulic Oil Filter.....	H-6301	Hydraulic Oil Filter.....	HC-45110
B8C (CONSTRUCTION EQUIPMENTS)		R100 (LOADERS) FORD E2703		6450 (AGRICULTURE) CHRYSLER 225	
Hydraulic Oil Filter.....	H-6301	Hydraulic Oil Filter.....	H-6301	Hydraulic Oil Filter.....	HC-7932
C20C (CONSTRUCTION EQUIPMENTS) HANOMAGH D162B		HAUL - PAK		6500AH (AGRICULTURE) PERKINS PERKINS	
Hydraulic Oil Filter.....	H-6301	35 (CONSTRUCTION EQUIPMENTS) CUMMINS NT-380		Hydraulic Oil Filter.....	HC-7906
		Hydraulic Oil Filter Transmission...	H-65030	Hydraulic Oil Filter.....	HC-7905
D600D (DOZERS)		35 (CONSTRUCTION EQUIPMENTS)		6500AH (EQUIPMENT) PERKINS	
Hydraulic Oil Filter.....	H-6301	Hydraulic Oil Filter Transmission...	H-65030	Hydraulic Oil Filter.....	HC-7906
K10 (DOZERS)		35 (CONSTRUCTION EQUIPMENTS)		6550 (AGRICULTURE) CHRYSLER 225	
Hydraulic Oil Filter.....	H-6301	Hydraulic Oil Filter Transmission...	H-65030	Hydraulic Oil Filter.....	HC-7932
K12 (DOZERS)		HAULOTTE		6600 (AGRICULTURE) CHRYSLER 225	
Hydraulic Oil Filter.....	H-6301	HA16PX (CARRY-LIFT)		Hydraulic Oil Filter.....	HC-7932
		Hydraulic Oil Filter.....	HC-6802		
K12C (DOZERS) HANOMAGH D562		HEATHFIELD ENGINEERING		6610 (AGRICULTURE) CHRYSLER 225	
Hydraulic Oil Filter.....	H-6301	DE50 (DUMP TRUCKS) CUMMINS NT-280		Hydraulic Oil Filter.....	HC-7932
		Hydraulic Oil Filter Transmission...	H-65030		
K12D (DOZERS)		HESSTON		6610 (AGRICULTURE) PERKINS PERKINS	
Hydraulic Oil Filter.....	H-6301	100-90 (EQUIPMENT)		Hydraulic Oil Filter.....	HC-5511
		Hydraulic Oil Filter.....	HC-45110		
K15 (DOZERS)		1180 (EQUIPMENT) FIAT		6610 (EQUIPMENT) PERKINS	
Hydraulic Oil Filter.....	H-6301	Hydraulic Oil Filter.....	HC-45110	Hydraulic Oil Filter.....	HC-5511
K18B (DOZERS)		130-90 (EQUIPMENT)		665C (EQUIPMENT)	
Hydraulic Oil Filter.....	H-6301	Hydraulic Oil Filter.....	HC-45110	Hydraulic Oil Filter.....	HC-45110
K18C (DOZERS)				90-90 (EQUIPMENT)	
Hydraulic Oil Filter.....	H-6301			Hydraulic Oil Filter.....	HC-45110



ENGINE APPLICATION

MODEL/APPLICATION	SAKURA NO	MODEL/APPLICATION	SAKURA NO	MODEL/APPLICATION	SAKURA NO
HEULIEZ		HITACHI		HITACHI	
GX317 (BUSES) IVECO CURSOR 8 , 2001-UP Hydraulic Oil Filter Transmission....	H-7102	Hydraulic Oil Filter.....	H-2719	Hydraulic Oil Filter.....	H-2704
GX317 (BUSES) RENAULTV MIDR 06.20.45 , 1995-2000 Hydraulic Oil Filter Transmission....	H-7102	CX900 (CRANES) MITSUBIS 6D24T (S/N: 000101-UP) , 2006 Hydraulic Oil Filter.....	HC-5602	Hydraulic Oil Filter.....	H-2703
HINO		Hydraulic Oil Filter.....	H-2719	Hydraulic Oil Filter.....	H-2714
338 (TRUCKS) HINO J08E , 2005-UP Hydraulic Oil Filter Transmission....	H-8538	CX900GLS (CRANES) MITSUBIS 6D24-TC (S/N: 25DP000123-UP) Hydraulic Oil Filter.....	HC-5602	EX1200-5 (EXCAVATORS) MITSUBIS 56R-Y1TAA1 Hydraulic Oil Filter.....	H-2703
Hydraulic Oil Filter Transmission..	H-8537-S	Hydraulic Oil Filter.....	H-2719	Hydraulic Oil Filter.....	H-2706
SG1J (TRUCKS) HINO J08C , 2004 Hydraulic Oil Filter Transmission..	H-8537-S	CX900HD (CRANES) MITSUBIS 6D24-TC (S/N: HCME 000101-UP) Hydraulic Oil Filter.....	H-2719	Hydraulic Oil Filter.....	H-2709
Hydraulic Oil Filter Transmission....	H-8538	Hydraulic Oil Filter.....	HC-5602	Hydraulic Oil Filter.....	HC-5602
SG3325 (TRUCKS) HINO J08C , 2004 Hydraulic Oil Filter Transmission..	H-8537-S	EX1100-3 (EXCAVATORS) CUMMINS QSK19 Hydraulic Oil Filter.....	HC-5602	EX1200-5C (EXCAVATORS) MITSUBIS 56R-Y1TAA1 Hydraulic Oil Filter.....	H-2706
Hydraulic Oil Filter Transmission....	H-8538	Hydraulic Oil Filter.....	H-2703	Hydraulic Oil Filter.....	H-2703
HITACHI		Hydraulic Oil Filter.....	H-2706	Hydraulic Oil Filter.....	H-2709
CX1100 (CRANES) ISUZU 6RB1T (S/N: 0503-UP) Hydraulic Oil Filter.....	HC-5602	EX1800-3 (EXCAVATORS) CUMMINS QSK19C Hydraulic Oil Filter.....	H-5505	Hydraulic Oil Filter.....	HC-5602
Hydraulic Oil Filter.....	H-2719	Hydraulic Oil Filter.....	H-2701	Hydraulic Oil Filter.....	H-2704
CX400 (CRANES) HINO H07C-TD (S/N: 000101-UP) Hydraulic Oil Filter.....	H-2706	EX100 (EXCAVATORS) ISUZU 4BD1 , 1988 Hydraulic Oil Filter.....	H-2703	EX120-2 (EXCAVATORS) ISUZU 4BD1T Hydraulic Oil Filter.....	H-2704
Hydraulic Oil Filter.....	HC-5602	Hydraulic Oil Filter.....	H-2714	Hydraulic Oil Filter.....	H-2703
Hydraulic Oil Filter.....	H-2719	Hydraulic Oil Filter.....	H-2704	Hydraulic Oil Filter.....	H-2704
CX500 (CRANES) HINO H07CT (S/N: 002003-UP) Hydraulic Oil Filter.....	HC-5602	EX1000 (EXCAVATORS) HITACHI 6RB1T , 1988 Hydraulic Oil Filter.....	H-2704	EX15 (EXCAVATORS) ISUZU 3KC1 , 1990 Hydraulic Oil Filter.....	HC-5807
Hydraulic Oil Filter.....	H-2706	Hydraulic Oil Filter.....	H-2701	Hydraulic Oil Filter.....	H-2712
Hydraulic Oil Filter.....	H-2719	EX100-2 (EXCAVATORS) ISUZU 4BD1 Hydraulic Oil Filter.....	H-2703	EX150 (EXCAVATORS) HITACHI 4BD1T , 1988 Hydraulic Oil Filter.....	H-2704
Hydraulic Oil Filter.....	H-2719	Hydraulic Oil Filter.....	H-2704	Hydraulic Oil Filter.....	H-2703
CX550-C (CRANES) HINO H07CT (S/N: 002141-UP) Hydraulic Oil Filter.....	HC-5602	EX100-2 (EXCAVATORS) ISUZU 4BDL Hydraulic Oil Filter.....	H-2704	EX150-5 (EXCAVATORS) ISUZU 4BG1T Hydraulic Oil Filter.....	H-2703
Hydraulic Oil Filter.....	H-2719	Hydraulic Oil Filter.....	H-2703	Hydraulic Oil Filter.....	H-2704
Hydraulic Oil Filter.....	H-2706	EX100-5 (EXCAVATORS) ISUZU 4BG1 Hydraulic Oil Filter.....	H-2703	EX150-5 (EXCAVATORS) ISUZU 4BG1T Hydraulic Oil Filter.....	H-2704
CX500S (CRANES) HINO H07CT (S/N: 002170-UP) Hydraulic Oil Filter.....	HC-5602	Hydraulic Oil Filter.....	H-2704	EX16-2 (EXCAVATORS) KUBOTA D1105-B Hydraulic Oil Filter.....	H-2712
Hydraulic Oil Filter.....	H-2719	EX1100 (EXCAVATORS) HITACHI KTTA19C Hydraulic Oil Filter.....	H-2703	Hydraulic Oil Filter.....	H-2712
Hydraulic Oil Filter.....	H-2706	Hydraulic Oil Filter.....	H-2706	EX16-2B (EXCAVATORS) KUBOTA D1105-B Hydraulic Oil Filter.....	HC-5807
CX700 (CRANES) HINO H07CT (S/N: 000101-UP) Hydraulic Oil Filter.....	H-2706	EX12 (EXCAVATORS) ISUZU 3KC1 , 1990 Hydraulic Oil Filter.....	H-2712	Hydraulic Oil Filter.....	H-2712
Hydraulic Oil Filter.....	H-2719	Hydraulic Oil Filter.....	HC-5807	EX17-2 (EXCAVATORS) KUBOTA D1105-B Hydraulic Oil Filter.....	HC-5807
Hydraulic Oil Filter.....	HC-5602	EX120 (EXCAVATORS) ISUZU 4BD1T , 1988		Hydraulic Oil Filter.....	H-2712
CX700HD (CRANES) MITSUBIS 6D24T (S/N: HCME 000101-UP) Hydraulic Oil Filter.....	HC-5602			EX17-2B (EXCAVATORS) KUBOTA D1105-B Hydraulic Oil Filter.....	H-2712



ENGINE APPLICATION

MODEL/APPLICATION	SAKURA NO	MODEL/APPLICATION	SAKURA NO	MODEL/APPLICATION	SAKURA NO
HITACHI		HITACHI		HITACHI	
EX1800 (EXCAVATORS) CUMMINS KTA-19C		EX160WD (EXCAVATORS) ISUZU 6BB1		Hydraulic Oil Filter.....	H-2712
Hydraulic Oil Filter.....	H-5505	Hydraulic Oil Filter.....	H-2706	EX255 (EXCAVATORS) CUMMINS	
Hydraulic Oil Filter.....	H-2730	Hydraulic Oil Filter.....	H-2703	Hydraulic Oil Filter.....	H-2706
Hydraulic Oil Filter.....	H-2701			Hydraulic Oil Filter.....	H-2703
EX1900-5 (EXCAVATORS) MITSUBISI S12A2-YTAA1		EX165 (EXCAVATORS) ISUZU 4BG1		EX255 (EXCAVATORS) ISUZU 6BG1T	
Hydraulic Oil Filter.....	H-2709	Hydraulic Oil Filter.....	H-2704	Hydraulic Oil Filter.....	H-2706
		Hydraulic Oil Filter.....	H-2703	Hydraulic Oil Filter.....	H-2703
EX100WD (EXCAVATORS) ISUZU 6BB1		EX165 (EXCAVATORS)		EX270 (EXCAVATORS) CUMMINS	
Hydraulic Oil Filter.....	H-2703	Hydraulic Oil Filter.....	H-2704	Hydraulic Oil Filter.....	H-2703
Hydraulic Oil Filter.....	H-2714	Hydraulic Oil Filter.....	H-2703		
Hydraulic Oil Filter.....	H-2704	EX165W (EXCAVATORS) CUMMINS 6BT5.9-C		EX270 (EXCAVATORS) HITACHI H06C-T	
EX100WD (EXCAVATORS) ISUZU 6BBL		Hydraulic Oil Filter.....	H-2704	Hydraulic Oil Filter.....	H-2706
Hydraulic Oil Filter.....	H-2703	EX22 (EXCAVATORS) ISUZU 3KR1 , 1990		Hydraulic Oil Filter.....	H-2703
Hydraulic Oil Filter.....	H-2714	Hydraulic Oil Filter.....	H-2719	EX27U (EXCAVATORS) ISUZU 3LD1	
Hydraulic Oil Filter.....	H-2704	EX200 (EXCAVATORS) HITACHI 6BD1T , 1988		Hydraulic Oil Filter.....	H-2712
EX100WD-2 (EXCAVATORS) ISUZU 4BD1T		Hydraulic Oil Filter.....	H-2706	EX29UE (EXCAVATORS) ISUZU 3LD1	
Hydraulic Oil Filter.....	H-2704	Hydraulic Oil Filter.....	H-2703	Hydraulic Oil Filter.....	H-2712
Hydraulic Oil Filter.....	H-2703	EX200-2 (EXCAVATORS) ISUZU 6BD1		EX210H-5 (EXCAVATORS) ISUZU 6BG1	
EX100WD-3 (EXCAVATORS) ISUZU		Hydraulic Oil Filter.....	H-2703	Hydraulic Oil Filter.....	H-2703
Hydraulic Oil Filter.....	H-2704	Hydraulic Oil Filter.....	H-2706	Hydraulic Oil Filter.....	H-2706
Hydraulic Oil Filter.....	H-2703	EX200-5 (EXCAVATORS) ISUZU 6BG1		EX215 (EXCAVATORS) IVECO	
EX1200-5D (EXCAVATORS) CUMMINS QSK23 (S/N: 003001-UP)		Hydraulic Oil Filter.....	H-2706	Hydraulic Oil Filter.....	H-2703
Hydraulic Oil Filter.....	HC-5602	Hydraulic Oil Filter.....	H-2703	Hydraulic Oil Filter.....	H-2706
Hydraulic Oil Filter.....	H-2706	EX220 (EXCAVATORS) HITACHI H06C-T		EX225USR (EXCAVATORS) ISUZU 6BG1T	
Hydraulic Oil Filter.....	H-2709	Hydraulic Oil Filter.....	H-2706	Hydraulic Oil Filter.....	H-2703
Hydraulic Oil Filter.....	H-2703	Hydraulic Oil Filter.....	H-2703	Hydraulic Oil Filter.....	H-2706
EX1200BE (EXCAVATORS)		EX220-2 (EXCAVATORS) HITACHI H06C-T		EX230LC-5 (EXCAVATORS) HINO H07C-TD	
Hydraulic Oil Filter.....	H-2706	Hydraulic Oil Filter.....	H-2706	Hydraulic Oil Filter.....	H-2706
Hydraulic Oil Filter.....	H-2703	Hydraulic Oil Filter.....	H-2703	Hydraulic Oil Filter.....	H-2703
Hydraulic Oil Filter.....	H-2709	EX220-5 (EXCAVATORS) HINO H07C-TD		EX235 (EXCAVATORS)	
Hydraulic Oil Filter.....	HC-5602	Hydraulic Oil Filter.....	H-2703	Hydraulic Oil Filter.....	H-2703
EX130 (EXCAVATORS) KUBOTA		Hydraulic Oil Filter.....	H-2706	EX285 (EXCAVATORS) CUMMINS	
Hydraulic Oil Filter.....	H-2719	EX22-2 (EXCAVATORS) KUBOTA D1105-B		Hydraulic Oil Filter.....	H-2706
EX130H-5 (EXCAVATORS) ISUZU 4BG1T		Hydraulic Oil Filter.....	H-2703	Hydraulic Oil Filter.....	H-2703
Hydraulic Oil Filter.....	H-2703	Hydraulic Oil Filter.....	H-2706	EX285 (EXCAVATORS) ISUZU 6BG1-TRA06 (S/N: TIER 2-UP)	
Hydraulic Oil Filter.....	H-2704	EX2500 (EXCAVATORS) CUMMINS KTA25C		Hydraulic Oil Filter.....	H-2706
EX135 (EXCAVATORS)		Hydraulic Oil Filter.....	H-2709	Hydraulic Oil Filter.....	H-2703
Hydraulic Oil Filter.....	H-2703	EX25-2 (EXCAVATORS) KUBOTA D1105-B		EX29U (EXCAVATORS)	
Hydraulic Oil Filter.....	H-2704	Hydraulic Oil Filter.....	H-2730	Hydraulic Oil Filter.....	H-2712
EX135UR (EXCAVATORS) ISUZU 4BG1					
Hydraulic Oil Filter.....	H-2703				
Hydraulic Oil Filter.....	H-2704				



ENGINE APPLICATION

MODEL/APPLICATION	SAKURA NO	MODEL/APPLICATION	SAKURA NO	MODEL/APPLICATION	SAKURA NO
HITACHI		HITACHI		HITACHI	
EX35 (EXCAVATORS) ISUZU 3KR2 , 1991		EX3500 (EXCAVATORS) HITACHI KT38C		Hydraulic Oil Filter.....	H-2703
Hydraulic Oil Filter.....	H-2719	Hydraulic Oil Filter.....	HC-5602	EX455-5 (EXCAVATORS) ISUZU 6RB1T	
EX30 (EXCAVATORS) ISUZU 3KR2 (S/N: HA03-UP)		Hydraulic Oil Filter.....	H-2730	Hydraulic Oil Filter.....	H-2709
Hydraulic Oil Filter.....	H-2719	Hydraulic Oil Filter.....	H-5505	Hydraulic Oil Filter.....	H-2703
EX300-2 (EXCAVATORS) ISUZU 6SD1T		EX350H-5 (EXCAVATORS) ISUZU 6SD1 TQA01		EX456 (EXCAVATORS) ISUZU 6WG1 (S/N: TIER 2-UP)	
Hydraulic Oil Filter.....	H-2706	Hydraulic Oil Filter.....	H-2706	Hydraulic Oil Filter.....	H-2703
Hydraulic Oil Filter.....	H-2703	Hydraulic Oil Filter.....	H-2703	EX50U (EXCAVATORS) ISUZU 4LE1	
EX300-3 (EXCAVATORS) ISUZU 6SD1T		EX355 (EXCAVATORS) ISUZU 6HK1-XQA01 (S/N: TIER 2-UP)		Hydraulic Oil Filter.....	H-2712
Hydraulic Oil Filter.....	H-2706	Hydraulic Oil Filter.....	H-2706	EX50UR (EXCAVATORS) ISUZU 3AB1	
Hydraulic Oil Filter.....	H-2703	Hydraulic Oil Filter.....	H-2703	Hydraulic Oil Filter.....	H-2703
EX300-5 (EXCAVATORS)		EX355 (EXCAVATORS) ISUZU 6SD1-TQA03		EX550 (EXCAVATORS) CUMMINS NTA-855	
Hydraulic Oil Filter.....	H-2703	Hydraulic Oil Filter.....	H-2706	Hydraulic Oil Filter.....	H-2703
EX300-LC (EXCAVATORS) 1993		Hydraulic Oil Filter.....	H-2703	Hydraulic Oil Filter.....	H-2709
Hydraulic Oil Filter.....	H-2703	EX370-5 (EXCAVATORS) ISUZU 6SD1 TQA01		EX550 (EXCAVATORS) CUMMINS N14-C400	
EX30-2 (EXCAVATORS) KUBOTA V1505 , 1992		Hydraulic Oil Filter.....	H-2706	Hydraulic Oil Filter.....	H-2703
Hydraulic Oil Filter.....	H-2712	Hydraulic Oil Filter.....	H-2703	EX550-5 (EXCAVATORS) CUMMINS N14-C400	
EX30U (EXCAVATORS) ISUZU 3LD1		EX40 (EXCAVATORS) ISUZU 43C1 , 1991		Hydraulic Oil Filter.....	H-2703
Hydraulic Oil Filter.....	H-2712	Hydraulic Oil Filter.....	H-2719	Hydraulic Oil Filter.....	H-2709
EX32UE (EXCAVATORS) ISUZU 3LD1 , 2003		EX400 (EXCAVATORS) HITACHI 6RB1T , 1988		EX550-5 (EXCAVATORS) CUMMINS N14-C400	
Hydraulic Oil Filter.....	H-2712	Hydraulic Oil Filter.....	H-2703	Hydraulic Oil Filter.....	H-2703
EX35U (EXCAVATORS) ISUZU 3LD1		EX400-3 (EXCAVATORS) ISUZU 6RB1-TPQ		Hydraulic Oil Filter.....	H-2730
Hydraulic Oil Filter.....	H-2712	Hydraulic Oil Filter.....	H-2703	Hydraulic Oil Filter.....	H-2709
EX3600-5 (EXCAVATORS) ISUZU		Hydraulic Oil Filter.....	H-2709	EX55UR (EXCAVATORS) NISSAN TD2340-10	
Hydraulic Oil Filter.....	HC-69031	Hydraulic Oil Filter.....	H-2703	Hydraulic Oil Filter.....	H-2719
Hydraulic Oil Filter.....	H-2709	Hydraulic Oil Filter Full Flow.....	HC-7901	EX55UR-3 (EXCAVATORS) ISUZU 4LE1	
Hydraulic Oil Filter.....	H-2730	EX40-2 (EXCAVATORS) KUBOTA V2203-B		Hydraulic Oil Filter.....	H-2712
EX36UE (EXCAVATORS) ISUZU 3LD1		Hydraulic Oil Filter.....	H-2712	EX60 (EXCAVATORS) HITACHI FD3304 , 1988	
Hydraulic Oil Filter.....	H-2712	EX40UR (EXCAVATORS) ISUZU		Hydraulic Oil Filter.....	H-2703
EX300 (EXCAVATORS) HITACHI EP100T		Hydraulic Oil Filter.....	H-2719	Hydraulic Oil Filter.....	H-2714
Hydraulic Oil Filter.....	H-2703	EX455-2 (EXCAVATORS)		EX600-3 (EXCAVATORS) CUMMINS N14-C400	
Hydraulic Oil Filter.....	H-2706	Hydraulic Oil Filter Full Flow.....	HC-7901	Hydraulic Oil Filter.....	H-2709
EX300LC-5 (EXCAVATORS) ISUZU 6SD1 TQA01		Hydraulic Oil Filter.....	H-2703	Hydraulic Oil Filter.....	H-2703
Hydraulic Oil Filter.....	H-2706	EX450-5 (EXCAVATORS) ISUZU 6RB1T		EX60-2 (EXCAVATORS) HITACHI BD3004 , 1992	
Hydraulic Oil Filter.....	H-2703	Hydraulic Oil Filter.....	H-2709	Hydraulic Oil Filter.....	H-2703
EX310H-3C (EXCAVATORS) ISUZU 6SD1T		Hydraulic Oil Filter.....	H-2703	EX60-5 (EXCAVATORS) NISSAN BD3004-19	
Hydraulic Oil Filter.....	H-2706	EX455 (EXCAVATORS) ISUZU 6RB1T		Hydraulic Oil Filter.....	H-2703
Hydraulic Oil Filter.....	H-2703			EX60UR (EXCAVATORS) ISUZU 4JB1 , 1990	



ENGINE APPLICATION

MODEL/APPLICATION	SAKURA NO	MODEL/APPLICATION	SAKURA NO	MODEL/APPLICATION	SAKURA NO
HITACHI		HITACHI		HITACHI	
EX60UR (EXCAVATORS) ISUZU 4J81 , 1990 Hydraulic Oil Filter.....	H-2703	EX8000 (EXCAVATORS) HITACHI , 2005 Hydraulic Oil Filter.....	H-2709	Hydraulic Oil Filter.....	H-2706
EX60WD (EXCAVATORS) HITACHI FD3304 , 1990 Hydraulic Oil Filter.....	H-2714	Hydraulic Oil Filter.....	H-2730	FH300 (EXCAVATORS) HITACHI 8365.SI.11.ALL011 Hydraulic Oil Filter.....	H-2706
Hydraulic Oil Filter.....	H-2703	EX800H-5 (EXCAVATORS) CUMMINS N14-C Hydraulic Oil Filter Full Flow.....	HC-7901	Hydraulic Oil Filter.....	H-2703
EX60WD-2 (EXCAVATORS) HITACHI BD3004 , 1992 Hydraulic Oil Filter.....	H-2703	Hydraulic Oil Filter.....	H-2703	FH330.3 (EXCAVATORS) ISUZU 6SD1T Hydraulic Oil Filter.....	H-2703
Hydraulic Oil Filter.....	H-2714	EX80-5 (EXCAVATORS) NISSAN BD3004-19 Hydraulic Oil Filter.....	H-2703	FH400 (EXCAVATORS) FIAT 8215.22.400 Hydraulic Oil Filter.....	H-2703
EX600 (EXCAVATORS) Hydraulic Oil Filter.....	H-2703	EX90 (EXCAVATORS) HITACHI 4BD1 , 1988 Hydraulic Oil Filter.....	H-2703	Hydraulic Oil Filter.....	H-2706
Hydraulic Oil Filter.....	H-2709	Hydraulic Oil Filter.....	H-2704	FH450-3 (EXCAVATORS) ISUZU 6RB1 Hydraulic Oil Filter.....	H-2703
EX600H-5 (EXCAVATORS) CUMMINS N14-C400 Hydraulic Oil Filter.....	H-2703	Hydraulic Oil Filter.....	H-2714	FR100 (LOADERS) IVECO Hydraulic Oil Filter.....	HC-7913
Hydraulic Oil Filter.....	H-2709	FH130-3 (EXCAVATORS) IVECO Hydraulic Oil Filter.....	H-2706	FR130 (LOADERS) FIAT 8065T Hydraulic Oil Filter Transmission...	HC-2701
EX60SR (EXCAVATORS) HITACHI FD3304 Hydraulic Oil Filter.....	H-2714	Hydraulic Oil Filter.....	H-2704	FR160 (LOADERS) FIAT 8365T Hydraulic Oil Filter Transmission...	HC-2701
Hydraulic Oil Filter.....	H-2703	FH130W-3 (EXCAVATORS) CUMMINS Hydraulic Oil Filter.....	H-2704	FR70 (LOADERS) Hydraulic Oil Filter.....	HC-7913
EX700 (EXCAVATORS) CUMMINS NTA-855 , 1995 Hydraulic Oil Filter.....	H-2703	Hydraulic Oil Filter.....	H-2706	FR90 (LOADERS) IVECO Hydraulic Oil Filter.....	HC-7913
EX750 (EXCAVATORS) CUMMINS N14 SERIES Hydraulic Oil Filter.....	H-2709	FH120 (EXCAVATORS) IVECO 8065T Hydraulic Oil Filter.....	H-2704	HX140B (FORKLIFTS) KUBOTA D1105-K , 2004 Hydraulic Oil Filter.....	H-2712
Hydraulic Oil Filter.....	H-2703	Hydraulic Oil Filter.....	H-2706	HX220B (FORKLIFTS) ISUZU 4BG1 , 2008 Hydraulic Oil Filter.....	H-2703
EX750-5 (EXCAVATORS) CUMMINS N14-C Hydraulic Oil Filter Full Flow.....	HC-7901	FH150W-3 (EXCAVATORS) CUMMINS Hydraulic Oil Filter.....	H-2704	Hydraulic Oil Filter.....	H-2706
Hydraulic Oil Filter.....	H-2703	Hydraulic Oil Filter.....	H-2706	HX99B (FORKLIFTS) KUBOTA D1105-BH , 2004 Hydraulic Oil Filter.....	H-2712
EX75UR (EXCAVATORS) Hydraulic Oil Filter.....	H-2703	FH200 (EXCAVATORS) IVECO Hydraulic Oil Filter.....	H-2703	KH125-3 (CRANES) HITACHI EM100 Hydraulic Oil Filter.....	H-2719
EX75UR-3 (EXCAVATORS) NISSAN BD3004-20 Hydraulic Oil Filter.....	H-2703	Hydraulic Oil Filter.....	H-2706	Hydraulic Oil Filter.....	H-7911
EX75US-7 (EXCAVATORS) ISUZU 4JG1 Hydraulic Oil Filter.....	H-2703	FH220 (EXCAVATORS) HITACHI 8365.SI.11.ALL.010 Hydraulic Oil Filter.....	H-2703	KH150-2 (CRANES) NISSAN PD604 Hydraulic Oil Filter.....	H-7911
EX800 (EXCAVATORS) Hydraulic Oil Filter.....	H-2703	Hydraulic Oil Filter.....	H-2706	KH150-3 (CRANES) HINO H06CT (S/N: 911-UP) Hydraulic Oil Filter.....	H-2719
Hydraulic Oil Filter Full Flow.....	HC-7901	FH270.3 (EXCAVATORS) CUMMINS 6CT8.3 Hydraulic Oil Filter.....	H-2706		
EX800-5 (EXCAVATORS) Hydraulic Oil Filter.....	H-2703	Hydraulic Oil Filter.....	H-2703		
Hydraulic Oil Filter Full Flow.....	HC-7901	FH240-3 (EXCAVATORS) IVECO (S/N: 244X0001-UP) Hydraulic Oil Filter.....	H-2703		
		Hydraulic Oil Filter.....	H-2706		
		FH240-3 (EXCAVATORS) IVECO (S/N: T0-223X9999) Hydraulic Oil Filter.....	H-2703		



ENGINE APPLICATION

MODEL/APPLICATION	SAKURA NO	MODEL/APPLICATION	SAKURA NO	MODEL/APPLICATION	SAKURA NO
HITACHI		HITACHI		HITACHI	
KH150-3 (CRANES) HITACHI BF10L513		Hydraulic Oil Filter.....	H-2719	UH063 (EXCAVATORS) ISUZU 6BD1	
Hydraulic Oil Filter.....	H-2719	Hydraulic Oil Filter.....	HC-5602	Hydraulic Oil Filter.....	H-2714
KH150-3 (CRANES) HITACHI EM100 (S/N: T0-910)		SCX2800-2 (CRANES) MITSUBISI 6M70-TL (S/N: TIER 3-UP) , 2008		UH07-5 (EXCAVATORS) HINO EL100	
Hydraulic Oil Filter.....	H-2719	Hydraulic Oil Filter.....	HC-5602	Hydraulic Oil Filter.....	H-2704
KH230-3 (CRANES) HINO EM100 (S/N: 106-UP)		SCX400 (CRANES) ISUZU BB-6HK1-TQA		UH07-7 (EXCAVATORS) ISUZU 6BD1T	
Hydraulic Oil Filter.....	H-2719	Hydraulic Oil Filter.....	H-2706	Hydraulic Oil Filter.....	H-2704
KH230-3 (CRANES) HINO EM100 (S/N: 2450199-UP)		Hydraulic Oil Filter.....	H-2719	Hydraulic Oil Filter.....	H-2704
Hydraulic Oil Filter.....	H-7911	Hydraulic Oil Filter.....	HC-5602	UH081 (EXCAVATORS) HINO EL100	
Hydraulic Oil Filter.....	H-2719	SCX900 (CRANES) MITSUBISI 6D24T		Hydraulic Oil Filter.....	H-2704
KH230-3 (CRANES) HINO EM100 (S/N: 2450200-UP)		Hydraulic Oil Filter.....	H-2719	UH083 (EXCAVATORS) ISUZU 6BD1	
Hydraulic Oil Filter.....	H-7911	Hydraulic Oil Filter.....	HC-5602	Hydraulic Oil Filter.....	H-2704
Hydraulic Oil Filter.....	H-2719	SCX900-2 (CRANES) MITSUBISI 6D24T (S/N: 000101-UP) , 2004		Hydraulic Oil Filter.....	H-2714
KH300-3 (CRANES) ISUZU 6RB1		Hydraulic Oil Filter.....	HC-5602	UH09-2 (EXCAVATORS) HINO EL100	
Hydraulic Oil Filter.....	H-2701	UH03 (EXCAVATORS) ISUZU DA220		Hydraulic Oil Filter.....	H-2704
Hydraulic Oil Filter.....	H-2719	Hydraulic Oil Filter.....	H-2701	UH09-7 (EXCAVATORS) HINO EM100	
KH500 (CRANES) ISUZU 12PB1		Hydraulic Oil Filter.....	H-2701	Hydraulic Oil Filter.....	H-2704
Hydraulic Oil Filter.....	H-5107	UH03M-2 (EXCAVATORS) HINO EC100A		UH04-5 (EXCAVATORS) ISUZU 6BBL	
KH500-3 (CRANES) ISUZU 6RB1T		Hydraulic Oil Filter.....	H-2701	Hydraulic Oil Filter.....	H-2704
Hydraulic Oil Filter.....	H-2719	UH04 (EXCAVATORS) HINO EC100		UH10 (EXCAVATORS) ISUZU 120	
KH700 (CRANES) ISUZU 12PB1 (S/N: 2530258-UP)		Hydraulic Oil Filter.....	H-2701	Hydraulic Oil Filter.....	H-2704
Hydraulic Oil Filter.....	H-2719	UH04 (EXCAVATORS) ISUZU 6BBL		UH103 (EXCAVATORS) HINO EM100	
KH850-3 (CRANES) ISUZU 6RB1T		Hydraulic Oil Filter.....	H-2701	Hydraulic Oil Filter.....	H-2704
Hydraulic Oil Filter.....	H-2719	UH043 (EXCAVATORS) ISUZU 4BB1		UH12 (EXCAVATORS) ISUZU EP100	
LX70 (LOADERS) ISUZU 4BD1		Hydraulic Oil Filter.....	H-2714	Hydraulic Oil Filter.....	H-2704
Hydraulic Oil Filter.....	H-2703	UH04-7 (EXCAVATORS) ISUZU 4BBL		UH123 (EXCAVATORS) HINO EM100	
PD9 (PILE DRIVERS) NISSAN PD604		Hydraulic Oil Filter.....	H-2704	Hydraulic Oil Filter.....	H-2714
Hydraulic Oil Filter.....	H-7911	UH051 (EXCAVATORS) ISUZU 6BB1		Hydraulic Oil Filter.....	H-2704
SCX550 (CRANES) ISUZU BB-6HK1-TQA		Hydraulic Oil Filter.....	H-2704	UH14 (EXCAVATORS) ISUZU E120	
Hydraulic Oil Filter.....	H-2706	UH051D (EXCAVATORS)		Hydraulic Oil Filter.....	H-2704
Hydraulic Oil Filter.....	HC-5602	Hydraulic Oil Filter.....	H-2704	Hydraulic Oil Filter.....	H-2701
Hydraulic Oil Filter.....	H-2719	UH052 (EXCAVATORS) ISUZU 6BB1		UH143 (EXCAVATORS) HITACHI EP100	
SCX550-3 (CRANES) ISUZU 4HK1		Hydraulic Oil Filter.....	H-2704	Hydraulic Oil Filter.....	H-2704
Hydraulic Oil Filter.....	H-2719	UH053 (EXCAVATORS) ISUZU 4BD1		UH171 (EXCAVATORS) ISUZU E120	
Hydraulic Oil Filter.....	H-2706	Hydraulic Oil Filter.....	H-2714	Hydraulic Oil Filter.....	H-2704
Hydraulic Oil Filter.....	HC-5602	UH061 (EXCAVATORS) ISUZU 6BD1		Hydraulic Oil Filter.....	H-2701
SCX700 (CRANES) ISUZU BB-6HK1-TQA		Hydraulic Oil Filter.....	H-2704	UH181 (EXCAVATORS) ISUZU 6RB1	
Hydraulic Oil Filter.....	H-2706				



ENGINE APPLICATION

MODEL/APPLICATION	SAKURA NO	MODEL/APPLICATION	SAKURA NO	MODEL/APPLICATION	SAKURA NO
HITACHI		HITACHI		HITACHI	
UH181 (EXCAVATORS) ISUZU 6RB1		ZW250 (LOADERS) ISUZU (S/N: 00101-UP) , 2006		ZX180W (EXCAVATORS)	
Hydraulic Oil Filter.....	H-2704	Hydraulic Oil Filter Transmission..	HC-76130	Hydraulic Oil Filter.....	H-2706
Hydraulic Oil Filter.....	H-2701			Hydraulic Oil Filter Return.....	H-7981
UH172 (EXCAVATORS)		ZX110 (EXCAVATORS) ISUZU 4BG1 TRG		ZX135USK (EXCAVATORS) ISUZU 4BG1 TCG (S/N: 060001-UP)	
Hydraulic Oil Filter.....	H-2704	Hydraulic Oil Filter.....	H-2703	Hydraulic Oil Filter.....	H-2703
UH20 (EXCAVATORS) ISUZU E120(2)		ZX120 (EXCAVATORS) ISUZU 4BG1T		ZX160LC (EXCAVATORS) ISUZU AA4BG1TC (S/N: 005001-UP)	
Hydraulic Oil Filter.....	H-2704	Hydraulic Oil Filter.....	H-2703	Hydraulic Oil Filter.....	H-2703
Hydraulic Oil Filter.....	H-2701	ZX125 (EXCAVATORS) S/N: 10572-UP		ZX160LC (EXCAVATORS)	
UH23 (EXCAVATORS) ISUZU E120 (QTY 2)		Hydraulic Oil Filter.....	H-2703	Hydraulic Oil Filter.....	H-2703
Hydraulic Oil Filter.....	H-2704	ZX125 (EXCAVATORS) S/N: TO-10571		ZX17U-2 (EXCAVATORS) YANMAR 3TNV70-VHB (S/N: 010001-UP) , 2007	
UH261 (EXCAVATORS) ISUZU E120		Hydraulic Oil Filter.....	H-2703	Hydraulic Oil Filter.....	H-2712
Hydraulic Oil Filter.....	H-2701	ZX125US-E (EXCAVATORS) ISUZU 4BG1T (S/N: 001001-UP)		ZX200LC (EXCAVATORS) ISUZU 6BG1TRA , 2002	
Hydraulic Oil Filter.....	H-2704	Hydraulic Oil Filter.....	H-2703	Hydraulic Oil Filter Return.....	H-7981
UH30 (EXCAVATORS)		ZX130 (EXCAVATORS) S/N: 60138-UP		Hydraulic Oil Filter.....	H-2703
Hydraulic Oil Filter.....	H-2704	Hydraulic Oil Filter.....	H-2703	Hydraulic Oil Filter.....	H-2706
Hydraulic Oil Filter.....	H-2701	ZX130 (EXCAVATORS) S/N: TO-60137		ZX210 (EXCAVATORS)	
UH43 (EXCAVATORS) HITACHI 4BB1		Hydraulic Oil Filter.....	H-2703	Hydraulic Oil Filter.....	H-2706
Hydraulic Oil Filter.....	H-2714	ZX135US (EXCAVATORS) ISUZU 4BG1 TCG (S/N: 060001-UP)		Hydraulic Oil Filter.....	H-2703
UH53 (EXCAVATORS) HITACHI 4BD1		Hydraulic Oil Filter.....	H-2703	Hydraulic Oil Filter Return.....	H-7981
Hydraulic Oil Filter.....	H-2714	ZX135US (EXCAVATORS) S/N: 62997-UP		Hydraulic Oil Filter.....	H-2706
UH801 (EXCAVATORS) CUMMINS KT-1150 (QTY 2)		Hydraulic Oil Filter.....	H-2703	ZX210W (EXCAVATORS) ISUZU AA6BG1T	
Hydraulic Oil Filter.....	H-2704	ZX135US (EXCAVATORS) S/N: TO-62996		Hydraulic Oil Filter Return.....	H-7981
UH81 (EXCAVATORS) HINO EL100		Hydraulic Oil Filter.....	H-2703	Hydraulic Oil Filter.....	H-2706
Hydraulic Oil Filter.....	H-2704	ZX16 (EXCAVATORS) ISUZU 3YB1		Hydraulic Oil Filter.....	H-2706
WH03 (EXCAVATORS) ISUZU DA220		Hydraulic Oil Filter.....	HC-5807	ZX240 (EXCAVATORS) ISUZU 6BG1	
Hydraulic Oil Filter.....	H-2701	Hydraulic Oil Filter.....	H-2712	Hydraulic Oil Filter.....	H-2706
WH04 (EXCAVATORS) ISUZU 6BB1		ZX18 (EXCAVATORS) ISUZU 3YB1		Hydraulic Oil Filter.....	H-2703
Hydraulic Oil Filter.....	H-2701	Hydraulic Oil Filter.....	HC-5807	Hydraulic Oil Filter Return.....	H-7981
WH04 (EXCAVATORS) ISUZU 6BB1		Hydraulic Oil Filter.....	H-2712	ZX25 (EXCAVATORS) ISUZU 3YE1	
Hydraulic Oil Filter.....	H-2701	ZX180 (EXCAVATORS)		Hydraulic Oil Filter.....	H-2712
WH051D (EXCAVATORS) ISUZU 6BB1		Hydraulic Oil Filter.....	H-2703	Hydraulic Oil Filter.....	HC-5807
Hydraulic Oil Filter.....	H-2704	ZX180LC (EXCAVATORS) ISUZU AA4BG1TCS (S/N: 005001-UP)		ZX250 (EXCAVATORS) ISUZU , 2005	
WH052 (EXCAVATORS) ISUZU 6BB1		Hydraulic Oil Filter.....	H-2703	Hydraulic Oil Filter Return.....	H-7981
Hydraulic Oil Filter.....	H-2704	ZX180W (EXCAVATORS) ISUZU AA-4BG1 (S/N: 001001-UP)		Hydraulic Oil Filter.....	H-2703
WH073D (EXCAVATORS) ISUZU 6BD1		Hydraulic Oil Filter.....	H-2706	Hydraulic Oil Filter.....	H-2706
Hydraulic Oil Filter.....	H-2704	Hydraulic Oil Filter Return.....	H-7981	ZX250LCN (EXCAVATORS) ISUZU CC 6BG1 (S/N: 010001-UP) , 2006	
Hydraulic Oil Filter.....	H-2704			Hydraulic Oil Filter.....	H-2706
				Hydraulic Oil Filter.....	H-2703



ENGINE APPLICATION

MODEL/APPLICATION	SAKURA NO	MODEL/APPLICATION	SAKURA NO	MODEL/APPLICATION	SAKURA NO
HITACHI		HITACHI		HITACHI	
ZX250LCN (EXCAVATORS) ISUZU CC 6BG1 (S/N: 010001-UP) , 2006		ZX30 (EXCAVATORS) KUBOTA V1505		Hydraulic Oil Filter.....	H-2712
ZX270 (EXCAVATORS) ISUZU 6BG1TRA02			Hydraulic Oil Filter.....	H-2712	
Hydraulic Oil Filter.....	H-2703	ZX30U (EXCAVATORS) ISUZU 3LD2 (S/N: 05001-UP)		Hydraulic Oil Filter Full Flow.....	HC-7901
Hydraulic Oil Filter Return.....	H-7981		Hydraulic Oil Filter.....	H-2712	Hydraulic Oil Filter.....
Hydraulic Oil Filter.....	H-2709	ZX30U-2 (EXCAVATORS) YANMAR 3TNV88 (S/N: 010001-UP) , 2006			H-2709
Hydraulic Oil Filter.....	H-2706		Hydraulic Oil Filter.....	H-2712	
ZX27U-2 (EXCAVATORS) YANMAR 3TNV88 (S/N: 010001-UP) , 2006		ZX35 (EXCAVATORS) KUBOTA V1505		ZX50U (EXCAVATORS) ISUZU 4LE2 (S/N: 1LE-005001-UP)	
Hydraulic Oil Filter.....	H-2712		Hydraulic Oil Filter.....	H-2712	
ZX280LC (EXCAVATORS) ISUZU 6BG1TRA02 (S/N: 020001-UP) , 2006			Hydraulic Oil Filter.....	H-2712	
Hydraulic Oil Filter.....	H-2703	ZX35U-2 (EXCAVATORS) YANMAR 3TNV88 (S/N: 010001-UP)			
Hydraulic Oil Filter.....	H-2706		Hydraulic Oil Filter.....	H-2712	
Hydraulic Oil Filter Return.....	H-7981	ZX450-3 (EXCAVATORS) ISUZU AH 6WG1 XYS-A-01 (S/N: 020001-UP) , 2006		ZX50U-2 (EXCAVATORS) YANMAR 4TNV88 (S/N: 010001-UP) , 2006	
ZX225US (EXCAVATORS) ISUZU 6BG1TTRA03			Hydraulic Oil Filter Full Flow.....	HC-7901	
Hydraulic Oil Filter Return.....	H-7981	ZX470LCH-3 (EXCAVATORS) ISUZU AH 6WG1 XYS-A-01 (S/N: 020001-UP) , 2008			
Hydraulic Oil Filter.....	H-2703		Hydraulic Oil Filter Full Flow.....	HC-7901	
Hydraulic Oil Filter.....	H-2706	ZX40 (EXCAVATORS) KUBOTA V2203		ZX520-3 (EXCAVATORS)	
ZX225US-E (EXCAVATORS) ISUZU 6BG1TTRA03			Hydraulic Oil Filter.....	H-2712	
Hydraulic Oil Filter.....	H-2706	ZX40U (EXCAVATORS) ISUZU 4LE2 (S/N: 1LD-005001-UP)		Hydraulic Oil Filter Full Flow.....	HC-7901
Hydraulic Oil Filter.....	H-2703		Hydraulic Oil Filter.....	H-2709	
ZX225USR (EXCAVATORS) ISUZU 6BG1T , 2002		ZX40U-2 (EXCAVATORS) YANMAR 4TNV88 (S/N: 010001-UP) , 2006		Hydraulic Oil Filter.....	H-2709
Hydraulic Oil Filter.....	H-2703		Hydraulic Oil Filter.....	H-2703	
Hydraulic Oil Filter Return.....	H-7981	ZX450 (EXCAVATORS) ISUZU 6WG1TQA		Hydraulic Oil Filter Full Flow.....	HC-7901
Hydraulic Oil Filter.....	H-2706		Hydraulic Oil Filter.....	H-2709	
ZX330-3 (CONSTRUCTION & MINING) 2008		ZX460LCH (EXCAVATORS)		Hydraulic Oil Filter.....	H-2703
Hydraulic Oil Filter.....	H-2724		Hydraulic Oil Filter.....	H-2703	
Hydraulic Oil Filter.....	HC-2709	ZX460LCH (EXCAVATORS)		Hydraulic Oil Filter Full Flow.....	HC-7901
ZX350H-3 (CONSTRUCTION & MINING) 2008			Hydraulic Oil Filter.....	H-2703	
Hydraulic Oil Filter.....	H-2724	ZX470-3 (EXCAVATORS)		Hydraulic Oil Filter Full Flow.....	HC-7901
Hydraulic Oil Filter.....	HC-2709		Hydraulic Oil Filter Full Flow.....	HC-7901	
ZX350LC (CONSTRUCTION & MINING) 2008		ZX500LC-3 (EXCAVATORS) ISUZU AH 6WG1 XYS-A-01 (S/N: 020001-UP) , 2006			
Hydraulic Oil Filter.....	HC-2709		Hydraulic Oil Filter Full Flow.....	HC-7901	
Hydraulic Oil Filter.....	H-2724	ZX520LCH-3 (EXCAVATORS) ISUZU AH 6WG1 XYS-A-01 (S/N: 020001-UP) , 2006			
ZX330 (EXCAVATORS) ISUZU AA6HK1XQA , 2002			Hydraulic Oil Filter Full Flow.....	HC-7901	
Hydraulic Oil Filter Return.....	H-7981	ZX50 (EXCAVATORS) KUBOTA V2203			
Hydraulic Oil Filter.....	H-2706		Hydraulic Oil Filter.....	H-2703	
Hydraulic Oil Filter.....	H-2703	ZX70 (EXCAVATORS)		Hydraulic Oil Filter.....	H-2703
ZX350 (EXCAVATORS) ISUZU , 2005					
Hydraulic Oil Filter.....	H-2703	ZX70LC (EXCAVATORS) ISUZU AA-4JG1		Hydraulic Oil Filter.....	H-2703
Hydraulic Oil Filter Return.....	H-7981		Hydraulic Oil Filter.....	H-2709	
Hydraulic Oil Filter.....	H-2706	ZX75UR (EXCAVATORS) ISUZU CC-4JG1 (S/N: 040001-UP)		Hydraulic Oil Filter.....	H-2703



ENGINE APPLICATION

MODEL/APPLICATION	SAKURA NO	MODEL/APPLICATION	SAKURA NO	MODEL/APPLICATION	SAKURA NO
HITACHI		HOUGH		HOUGH	
ZX75US (EXCAVATORS) 2008		D400 (CONSTRUCTION EQUIPMENTS) CUMMINS VT-12-525		Hydraulic Oil Filter Transmission...	H-65030
Hydraulic Oil Filter.....	H-2703	Hydraulic Oil Filter Transmission...	H-65030	H-30R SERIES B (CONSTRUCTION EQUIPMENTS) DETROITD 3-53	
ZX75US (EXCAVATORS) ISUZU 4JG1		D400 (CONSTRUCTION EQUIPMENTS) DETROITD 12V-71		Hydraulic Oil Filter Transmission...	H-65030
Hydraulic Oil Filter.....	H-2703	Hydraulic Oil Filter Transmission...	H-65030	H-30R SERIES B (CONSTRUCTION EQUIPMENTS) IHC U-236	
ZX850LC-3 (EXCAVATORS) ISUZU AH 6WG1 XYS A-03 (S/N: 020001-UP) , 2006		D500 (LOADERS) CUMMINS VTA28-C		Hydraulic Oil Filter Transmission...	H-65030
Hydraulic Oil Filter Full Flow.....	HC-7901	Hydraulic Oil Filter Transmission...	H-65030	H-30R SERIES B (CONSTRUCTION EQUIPMENTS) IHC U-240	
ZX870LCH-3 (EXCAVATORS) ISUZU AH 6WG1 XYS A-03 (S/N: 020001-UP) , 2006		D500 (LOADERS) DETROITD 16V-71		Hydraulic Oil Filter Transmission...	H-65030
Hydraulic Oil Filter Full Flow.....	HC-7901	Hydraulic Oil Filter Transmission...	H-65030	H-40 (CONSTRUCTION EQUIPMENTS) IHC G-264	
ZX80 (EXCAVATORS) ISUZU AA-4JG1		D90 SERIES C (LOADERS) CUMMINS V6R-180		Hydraulic Oil Filter Transmission...	H-65030
Hydraulic Oil Filter.....	H-2703	Hydraulic Oil Filter Transmission...	H-65030	H-40 (CONSTRUCTION EQUIPMENTS) IHC UD-282	
ZX80SB (EXCAVATORS) ISUZU AA-4JG1		D90 SERIES C (LOADERS) IHC DT573		Hydraulic Oil Filter Transmission...	H-65030
Hydraulic Oil Filter.....	H-2703	Hydraulic Oil Filter Transmission...	H-65030	H400B (LOADERS)	
ZX8-2 (EXCAVATORS) YANMAR 3TNV70 , 2008		H100B (SHOVELS) IHC BD264		Hydraulic Oil Filter Transmission...	H-65030
Hydraulic Oil Filter.....	H-2712	Hydraulic Oil Filter Transmission...	H-65030	H-50 SERIES B (CONSTRUCTION EQUIPMENTS) DETROITD 3-53	
ZX850 (EXCAVATORS) ISUZU 6WG1		H100C (CONSTRUCTION EQUIPMENTS) IHC DT817		Hydraulic Oil Filter Transmission...	H-65030
Hydraulic Oil Filter.....	H-2703	Hydraulic Oil Filter Transmission...	H-65030	H-50 SERIES B (CONSTRUCTION EQUIPMENTS) IHC G-301	
Hydraulic Oil Filter Full Flow.....	HC-7901	H100C (LOADERS)		Hydraulic Oil Filter Transmission...	H-65030
ZX85US (EXCAVATORS) ISUZU 4JG1		Hydraulic Oil Filter Transmission...	H-65030	H-50 SERIES B (CONSTRUCTION EQUIPMENTS) IHC UD-282	
Hydraulic Oil Filter.....	H-2703	H120 (LOADERS)		Hydraulic Oil Filter Transmission...	H-65030
ZX870-3 (EXCAVATORS) 2006		Hydraulic Oil Filter Transmission...	H-65030	H-50 SERIES C (CONSTRUCTION EQUIPMENTS) IHC D282	
Hydraulic Oil Filter Full Flow.....	HC-7901	H120C (CONSTRUCTION EQUIPMENTS) IHC DT817		Hydraulic Oil Filter.....	H-5640
HOUGH		Hydraulic Oil Filter Transmission...	H-65030	H50B (SHOVELS)	
D100 (CONSTRUCTION EQUIPMENTS) CUMMINS NH220		H120C (CONSTRUCTION EQUIPMENTS) IHC DT817B		Hydraulic Oil Filter Transmission...	H-65030
Hydraulic Oil Filter Transmission...	H-65030	Hydraulic Oil Filter Transmission...	H-65030	H50C (LOADERS)	
D100 (CONSTRUCTION EQUIPMENTS) CUMMINS NT-855		H120C (SHOVELS)		Hydraulic Oil Filter.....	H-5640
Hydraulic Oil Filter Transmission...	H-65030	Hydraulic Oil Filter Transmission...	H-65030	H-60 (CONSTRUCTION EQUIPMENTS) DETROITD 3-71	
D100 (CONSTRUCTION EQUIPMENTS) CUMMINS NH250		H30 SERIES B (CONSTRUCTION EQUIPMENTS) DETROITD 3-53		Hydraulic Oil Filter Transmission...	H-65030
Hydraulic Oil Filter Transmission...	H-65030	Hydraulic Oil Filter Transmission...	H-65030	H-60 (CONSTRUCTION EQUIPMENTS) IHC G-372	
D100 (CONSTRUCTION EQUIPMENTS) IHC		H30 SERIES B (CONSTRUCTION EQUIPMENTS) IHC G-263		Hydraulic Oil Filter Transmission...	H-65030
Hydraulic Oil Filter Transmission...	H-65030	Hydraulic Oil Filter Transmission...	H-65030	H-60 SERIES B (CONSTRUCTION EQUIPMENTS) CUMMINS V-352-C	
D120 (CONSTRUCTION EQUIPMENTS) IHC DT817		H30 SERIES B (CONSTRUCTION EQUIPMENTS) IHC UD-236		Hydraulic Oil Filter.....	H-5640
Hydraulic Oil Filter Transmission...	H-65030	Hydraulic Oil Filter Transmission...	H-65030	H-60 SERIES B (CONSTRUCTION EQUIPMENTS) IHC D301	
D120 (CONSTRUCTION EQUIPMENTS) IHC DT817B		H30B (LOADERS)		Hydraulic Oil Filter.....	H-5640
Hydraulic Oil Filter Transmission...	H-65030	Hydraulic Oil Filter Transmission...	H-65030	H-65 (CONSTRUCTION EQUIPMENTS) IHC G-372	



ENGINE APPLICATION

MODEL/APPLICATION	SAKURA NO	MODEL/APPLICATION	SAKURA NO	MODEL/APPLICATION	SAKURA NO
HOUGH		HOUGH		HYDRA-MAC	
H-65 (CONSTRUCTION EQUIPMENTS) IHC G-372 Hydraulic Oil Filter Transmission...	H-65030	H90E (CONSTRUCTION EQUIPMENTS) IHC DT573B Hydraulic Oil Filter.....	H-5640	12C (CONSTRUCTION & MINING) PERKINS 4.108 Hydraulic Oil Filter.....	HC-5511
H-65 SERIES B (CONSTRUCTION EQUIPMENTS) DETROIT 3-71 Hydraulic Oil Filter Transmission...	H-65030	H90E (CONSTRUCTION EQUIPMENTS) Hydraulic Oil Filter.....	H-5640	12C (LOADERS) CHRYSLER Hydraulic Oil Filter.....	HC-5511
H65C (CONSTRUCTION EQUIPMENTS) IHC DT414 Hydraulic Oil Filter.....	H-5640	Hydraulic Oil Filter.....	H-5640	12C (LOADERS) FORD 98 Hydraulic Oil Filter.....	HC-5511
H-70 SERIES B (CONSTRUCTION EQUIPMENTS) IHC U-372 Hydraulic Oil Filter Transmission...	H-65030	HH (CONSTRUCTION EQUIPMENTS) HERCULES DJXH Hydraulic Oil Filter Transmission...	H-65030	12C (LOADERS) ISUZU Hydraulic Oil Filter.....	HC-5511
H-70 SERIES C (CONSTRUCTION EQUIPMENTS) CUMMINS C-160 Hydraulic Oil Filter Transmission...	H-65030	HO (CONSTRUCTION EQUIPMENTS) HERCULES WXLC-3 Hydraulic Oil Filter Transmission...	H-65030	12C (LOADERS) PERKINS 4.108 Hydraulic Oil Filter.....	HC-5511
H-70 SERIES C (CONSTRUCTION EQUIPMENTS) DETROIT 4-71 Hydraulic Oil Filter Transmission...	H-65030	T-180F (LOADERS) Hydraulic Oil Filter.....	H-5405	18 (CONSTRUCTION & MINING) FORD 172 GAS Hydraulic Oil Filter.....	HC-5511
H-80 (CONSTRUCTION EQUIPMENTS) IHC DT429 Hydraulic Oil Filter.....	H-5640	HUDDIG		Hydraulic Oil Filter.....	HC-5511
H80A (LOADERS) Hydraulic Oil Filter.....	H-5640	960 (TRACTORS) VALMET 411DS Hydraulic Oil Filter.....	H-85110	8A (LOADERS) ONAN Hydraulic Oil Filter.....	HC-5511
H-90 (CONSTRUCTION EQUIPMENTS) DETROIT 4-71 Hydraulic Oil Filter Transmission...	H-65030	HUNAN SUNWARD MACHINERY CO., LTD		HYMAC FAICEY	
H-90 (CONSTRUCTION EQUIPMENTS) HERCULES WXLC-3 Hydraulic Oil Filter Transmission...	H-65030	SWE70 (EXCAVATORS) CUMMINS A2300T , 2009-UP Hydraulic Oil Filter.....	H-2719	370 (EXCAVATORS) FORD Hydraulic Oil Filter.....	H-42020
H-90 SERIES B (CONSTRUCTION EQUIPMENTS) CUMMINS C-175 Hydraulic Oil Filter Transmission...	H-65030	SWE28 (EXCAVATORS) YANMAR 3TNV88 , 2009-UP Hydraulic Oil Filter.....	H-2719	590C (EXCAVATORS) PERKINS 6.354 Hydraulic Oil Filter.....	H-62040
H-90 SERIES C (CONSTRUCTION EQUIPMENTS) CUMMINS V6R-180-C1 Hydraulic Oil Filter Transmission...	H-65030	SWE55 (EXCAVATORS) YANMAR 4TNV88-SSV , 2009-UP Hydraulic Oil Filter.....	H-2719	590C (EXCAVATORS) PERKINS T6.354 Hydraulic Oil Filter.....	H-62040
H-90 SERIES B (CONSTRUCTION EQUIPMENTS) DETROIT 4-71 Hydraulic Oil Filter Transmission...	H-65030	HURLIMANN		595 (EXCAVATORS) PERKINS 6.354.4 T6.354 Hydraulic Oil Filter.....	H-62040
H-90 SERIES C (CONSTRUCTION EQUIPMENTS) IHC DT573 Hydraulic Oil Filter.....	H-5640	H496 (TRACTORS) Hydraulic Oil Filter.....	HC-51040	BT33F (EXCAVATORS) DETROIT 12V-71 Hydraulic Oil Filter Transmission...	H-65030
H-90 SERIES C (LOADERS) IHC DVT-573 Hydraulic Oil Filter.....	H-5640	H5116 (TRACTORS) Hydraulic Oil Filter.....	HC-51040	D111A (EXCAVATORS) Hydraulic Oil Filter Transmission...	H-65030
H90C (LOADERS) Hydraulic Oil Filter.....	H-5640	H6160 TURBO (TRACTORS) Hydraulic Oil Filter.....	HC-51040	LW30 (EXCAVATORS) CUMMINS NT-335 Hydraulic Oil Filter Transmission...	H-65030
H90E (CONSTRUCTION EQUIPMENTS) IHC DT573 Hydraulic Oil Filter.....	H-5640	HYDRA-MAC		LW40 (EXCAVATORS) DETROIT 12V-71 Hydraulic Oil Filter Transmission...	H-65030
		12C (CONSTRUCTION & MINING) FORD 98 , 1998 Hydraulic Oil Filter.....	HC-5511	HYSTER	
		12C (CONSTRUCTION & MINING) CHRYSLER CHRYSLER Hydraulic Oil Filter.....	HC-5511	44.16 (FORKLIFTS) CUMMINS QSM11-C Hydraulic Oil Filter.....	HC-5503
		12C (CONSTRUCTION & MINING) ISUZU ISUZU Hydraulic Oil Filter.....	HC-5511		



ENGINE APPLICATION

MODEL/APPLICATION	SAKURA NO	MODEL/APPLICATION	SAKURA NO	MODEL/APPLICATION	SAKURA NO
HYSTER		HYSTER		HYUNDAI	
44.16 (<i>FORKLIFTS</i>) CUMMINS QSM11-C		Hydraulic Oil Filter Transmission... TC-7918		HL730-7 (<i>LOADERS</i>) CUMMINS B3.9C , 2004-UP	
H2.00-3.20XM (<i>FORKLIFTS</i>)		Hydraulic Oil Filter..... H-5902		Hydraulic Oil Filter..... H-2719	
Hydraulic Oil Filter Transmission... TC-7918		S25XL-S35XL (<i>FORKLIFTS</i>) MAZDA M4-121G GAS (S/N: B10-UP)		HL740-3 (<i>LOADERS</i>) CUMMINS	
H200XM (<i>FORKLIFTS</i>)		Hydraulic Oil Filter Transmission... TC-7918		Hydraulic Oil Filter Transmission... HC-2701	
Hydraulic Oil Filter Transmission... TC-7918		Hydraulic Oil Filter..... H-5902		Hydraulic Oil Filter..... H-2719	
H25XL-H35XL (<i>FORKLIFTS</i>) MAZDA M4-121G GAS (S/N: C10-UP)		S40XL-S60XL (<i>FORKLIFTS</i>) MAZDA M4-121G (S/N: A187-UP)		HL740-7 (<i>LOADERS</i>) CUMMINS QSB5.9-C , 2004-UP	
Hydraulic Oil Filter..... H-5902		Hydraulic Oil Filter Transmission... TC-7918		Hydraulic Oil Filter..... H-2719	
Hydraulic Oil Filter Transmission... TC-7918		Hydraulic Oil Filter..... H-5902		HL740-7A (<i>LOADERS</i>) CUMMINS QSB6.7 , 2007-UP	
H3.00XM (<i>FORKLIFTS</i>)		HYUNDAI		Hydraulic Oil Filter..... H-2719	
Hydraulic Oil Filter Transmission... TC-7918		33HDL (<i>EXCAVATORS</i>)		HL740TM-3 (<i>LOADERS</i>) CUMMINS	
H30H-H60H (<i>FORKLIFTS</i>) GMC 4-181 GAS (S/N: E3D-E3T)		Hydraulic Oil Filter..... H-2719		Hydraulic Oil Filter Transmission... HC-2701	
Hydraulic Oil Filter Transmission... TC-7918		Hydraulic Oil Filter..... HC-7940		Hydraulic Oil Filter..... H-2719	
H40.000E (<i>FORKLIFTS</i>)		Hydraulic Oil Filter..... H-2725		HL750 (<i>LOADERS</i>) CUMMINS 6BT5.9	
Hydraulic Oil Filter..... HC-5503		42HDL (<i>EXCAVATORS</i>)		Hydraulic Oil Filter..... H-2719	
Hydraulic Oil Filter..... H-57030		Hydraulic Oil Filter..... HC-7940		HL750TM (<i>LOADERS</i>)	
H400XL (<i>FORKLIFTS</i>) 2007-UP		Hydraulic Oil Filter..... H-2719		Hydraulic Oil Filter..... H-2719	
Hydraulic Oil Filter Transmission... TC-7918		HL17 (<i>LOADERS</i>) CUMMINS 6BT5.9		HL757-7 (<i>LOADERS</i>) CUMMINS QSB5.9-C173 , 2004-UP	
Hydraulic Oil Filter..... H-5902		Hydraulic Oil Filter..... H-2719		Hydraulic Oil Filter..... H-2719	
H40X2 (<i>FORKLIFTS</i>)		HL19 (<i>LOADERS</i>) CUMMINS 6CT8.3		HL760 (<i>LOADERS</i>) CUMMINS 6CT8.3	
Hydraulic Oil Filter Transmission... TC-7918		Hydraulic Oil Filter..... H-2719		Hydraulic Oil Filter Transmission... HC-76130	
H40XL-H60XL (<i>FORKLIFTS</i>) MAZDA M4-121G (S/N: A177-UP)		Hydraulic Oil Filter Transmission... HC-2701		Hydraulic Oil Filter..... H-2719	
Hydraulic Oil Filter..... H-5902		HL35 (<i>LOADERS</i>) CUMMINS LTA10		Hydraulic Oil Filter Transmission... HC-2701	
Hydraulic Oil Filter Transmission... TC-7918		Hydraulic Oil Filter..... H-2719		HL760-7 (<i>LOADERS</i>) 2006-UP	
H5.50XL (<i>FORKLIFTS</i>) S/N: C177812771N-UP		HL770 (<i>LOADERS</i>) CUMMINS LTA10		Hydraulic Oil Filter..... H-2719	
Hydraulic Oil Filter..... H-5902		Hydraulic Oil Filter..... H-2719		Hydraulic Oil Filter..... H-2719	
Hydraulic Oil Filter Transmission... TC-7918		Hydraulic Oil Filter..... HC-6802		HL770-7 (<i>LOADERS</i>) 2006-UP	
H60C (<i>FORKLIFTS</i>) PERKINS		HL770-7A (<i>LOADERS</i>) CUMMINS QSL9-C220 , 2007-UP		Hydraulic Oil Filter..... H-2719	
Hydraulic Oil Filter Transmission... H-65030		Hydraulic Oil Filter..... H-2719		HL780-3 (<i>LOADERS</i>) CUMMINS N14 SERIES , 2004-UP	
H620B (<i>FORKLIFTS</i>) S/N: B8E1737-UP		HL770-7A (<i>LOADERS</i>) CUMMINS QSL9-C280 , 2007-UP		Hydraulic Oil Filter..... HC-5503	
Hydraulic Oil Filter Transmission... H-65030		Hydraulic Oil Filter..... H-2719		Hydraulic Oil Filter..... H-2719	
M-200H (<i>FORKLIFTS</i>)		HL720-3 (<i>LOADERS</i>) DEUTZ BF4M1012		HL780-3A (<i>LOADERS</i>) 2004-UP	
Hydraulic Oil Filter..... H-5503		Hydraulic Oil Filter..... H-2719		Hydraulic Oil Filter Transmission... HC-76130	
P-125A (<i>FORKLIFTS</i>)		HL730-3 (<i>LOADERS</i>) CUMMINS		Hydraulic Oil Filter..... H-2719	
Hydraulic Oil Filter..... H-5503		Hydraulic Oil Filter Transmission... HC-2701		LC250 (<i>LOADERS</i>)	
S25XL-S35XL (<i>FORKLIFTS</i>) MAZDA M4-121G (S/N: B10-UP)		HL730-3 (<i>LOADERS</i>) DEUTZ BF4M1012		Hydraulic Oil Filter..... H-2725	
		Hydraulic Oil Filter Transmission... HC-2701		R110-7 (<i>EXCAVATORS</i>) 2006-UP	
		Hydraulic Oil Filter..... H-2719		Hydraulic Oil Filter..... H-2719	
				Hydraulic Oil Filter..... HC-7940	



ENGINE APPLICATION

MODEL/APPLICATION	SAKURA NO	MODEL/APPLICATION	SAKURA NO	MODEL/APPLICATION	SAKURA NO
HYUNDAI		HYUNDAI		HYUNDAI	
R110-7 (EXCAVATORS) 2006-UP		Hydraulic Oil Filter.....	HC-7940	R290LC (EXCAVATORS)	
Hydraulic Oil Filter.....	H-2725	R180LC-7 (EXCAVATORS) 2006-UP		Hydraulic Oil Filter.....	H-2719
R120W (EXCAVATORS) CUMMINS 4BTA3.9		Hydraulic Oil Filter.....	H-2719	Hydraulic Oil Filter.....	HC-7940
Hydraulic Oil Filter.....	H-2719	Hydraulic Oil Filter.....	HC-7940	R290LC-3 (EXCAVATORS) CUMMINS 6CT8.3	
Hydraulic Oil Filter.....	HC-7940	R200W-3 (EXCAVATORS) 2006-UP		Hydraulic Oil Filter.....	H-2719
R130LC (EXCAVATORS) CUMMINS 4BTA3.9		Hydraulic Oil Filter.....	HC-7940	Hydraulic Oil Filter.....	HC-7940
Hydraulic Oil Filter.....	H-2719	Hydraulic Oil Filter.....	H-2725	R290LC-3 (EXCAVATORS) HYUNDAI	
Hydraulic Oil Filter.....	HC-7940	R200W-7 (EXCAVATORS) 2006-UP		Hydraulic Oil Filter.....	H-2719
R130W-3 (EXCAVATORS) 2006-UP		Hydraulic Oil Filter.....	HC-7940	Hydraulic Oil Filter.....	HC-7940
Hydraulic Oil Filter.....	HC-7940	Hydraulic Oil Filter.....	H-2719	R290LC-3LL/RB (EXCAVATORS)	
Hydraulic Oil Filter.....	H-2719	Hydraulic Oil Filter.....	H-2725	Hydraulic Oil Filter.....	H-2719
R140LC-7 (EXCAVATORS) 2006-UP		R210LC-3LL (EXCAVATORS)		Hydraulic Oil Filter.....	HC-7940
Hydraulic Oil Filter.....	HC-7940	Hydraulic Oil Filter.....	HC-7940	R290LC-7 (EXCAVATORS) S/N: TIER II-UP , 2006-UP	
Hydraulic Oil Filter.....	H-2719	Hydraulic Oil Filter.....	H-2725	Hydraulic Oil Filter.....	H-2719
Hydraulic Oil Filter.....	H-2725	Hydraulic Oil Filter.....	H-2719	Hydraulic Oil Filter.....	HC-7940
R140W-7 (EXCAVATORS) 2006-UP		R210LC-7 (EXCAVATORS) CUMMINS B5.9C , 2006-UP		R290LC-7A (EXCAVATORS) CUMMINS QSB6.7 , 2007-UP	
Hydraulic Oil Filter.....	HC-7940	Hydraulic Oil Filter.....	H-2725	Hydraulic Oil Filter.....	HC-7940
Hydraulic Oil Filter.....	H-2719	Hydraulic Oil Filter.....	H-2719	R305LC-7 (EXCAVATORS) 2006-UP	
Hydraulic Oil Filter.....	H-2725	Hydraulic Oil Filter.....	HC-7940	Hydraulic Oil Filter.....	H-2719
R160LC-3 (EXCAVATORS) CUMMINS , 2006-UP		R210LC-7H (EXCAVATORS) 2006-UP		Hydraulic Oil Filter.....	HC-7940
Hydraulic Oil Filter.....	HC-7940	Hydraulic Oil Filter.....	H-2719	R320LC (EXCAVATORS) CUMMINS LT10	
Hydraulic Oil Filter.....	H-2719	Hydraulic Oil Filter.....	H-2725	Hydraulic Oil Filter.....	H-2719
R160LC-7 (EXCAVATORS) 2006-UP		Hydraulic Oil Filter.....	HC-7940	Hydraulic Oil Filter.....	HC-7940
Hydraulic Oil Filter.....	HC-7940	R210NLC-7 (EXCAVATORS) 2006-UP		R320LC-3 (EXCAVATORS) CUMMINS M11	
Hydraulic Oil Filter.....	H-2719	Hydraulic Oil Filter.....	H-2725	Hydraulic Oil Filter.....	HC-7940
Hydraulic Oil Filter.....	H-2725	Hydraulic Oil Filter.....	H-2719	Hydraulic Oil Filter.....	H-2719
R170W-3 (EXCAVATORS) CUMMINS 6BTA5.9		Hydraulic Oil Filter.....	HC-7940	R320LC-7 (EXCAVATORS) CUMMINS , 2005-UP	
Hydraulic Oil Filter.....	HC-7940	R250LC-3 (EXCAVATORS) CUMMINS 6BT5.9		Hydraulic Oil Filter.....	H-2719
Hydraulic Oil Filter.....	H-2725	Hydraulic Oil Filter.....	H-2719	Hydraulic Oil Filter.....	HC-7940
Hydraulic Oil Filter.....	H-2719	Hydraulic Oil Filter.....	H-2725	R320LC-7A (EXCAVATORS) CUMMINS QSC , 2008-UP	
R170W-7 (EXCAVATORS) 2006-UP		Hydraulic Oil Filter.....	HC-7940	Hydraulic Oil Filter.....	HC-7940
Hydraulic Oil Filter.....	HC-7940	R250LC-7 (EXCAVATORS) 2006-UP		R320LC-7A (EXCAVATORS) CUMMINS QSC , 2008-UP	
Hydraulic Oil Filter.....	H-2725	Hydraulic Oil Filter.....	HC-7940	Hydraulic Oil Filter.....	HC-7940
Hydraulic Oil Filter.....	H-2719	Hydraulic Oil Filter.....	H-2725	R360LC-3 (EXCAVATORS) CUMMINS LTA10	
R180LC-3 (EXCAVATORS) CUMMINS 6BT5.9		Hydraulic Oil Filter.....	H-2719	Hydraulic Oil Filter.....	H-2719
Hydraulic Oil Filter.....	H-2725	R250LC-7A (EXCAVATORS) CUMMINS QSB6.7 , 2008-UP		Hydraulic Oil Filter.....	HC-7940
Hydraulic Oil Filter.....	H-2719	Hydraulic Oil Filter.....	HC-7940	R360LC-3 (EXCAVATORS) CUMMINS LTA10	
Hydraulic Oil Filter.....	HC-7940	R280LC (EXCAVATORS)		Hydraulic Oil Filter.....	H-2719
R180LC-3 (EXCAVATORS) HYUNDAI		Hydraulic Oil Filter.....	H-2719	Hydraulic Oil Filter.....	HC-7940
Hydraulic Oil Filter.....	H-2725	Hydraulic Oil Filter.....	H-2725	R360LC-3 (EXCAVATORS) HYUNDAI D6AZ	
Hydraulic Oil Filter.....	H-2719			Hydraulic Oil Filter.....	H-2719



ENGINE APPLICATION

MODEL/APPLICATION	SAKURA NO	MODEL/APPLICATION	SAKURA NO	MODEL/APPLICATION	SAKURA NO
HYUNDAI		HYUNDAI		IHI	
R360LC-3 (EXCAVATORS) HYUNDAI D6AZ		Hydraulic Oil Filter.....	H-5609	INGERSOLL RAND	
Hydraulic Oil Filter.....	HC-7940	ROBEX 200LC (EXCAVATORS) CUMMINS 6BT5.9		825 (AIR COMPRESSORS) CUMMINS M11	
Hydraulic Oil Filter.....	H-2719	Hydraulic Oil Filter.....	H-2719	Hydraulic Oil Filter.....	HC-6901
R360LC-7 (EXCAVATORS) CUMMINS QSC8.3 , 2005-UP		Hydraulic Oil Filter.....	H-2725	Hydraulic Oil Filter.....	HC-6901
Hydraulic Oil Filter.....	HC-7940	ROBEX 210-3 (EXCAVATORS) CUMMINS 6BT5.9		926 (CONSTRUCTION & MINING) PERKINS 4.236	
Hydraulic Oil Filter.....	H-2719	Hydraulic Oil Filter.....	H-2719	Hydraulic Oil Filter.....	HC-7905
R450LC-3 (EXCAVATORS) CUMMINS LTA10		Hydraulic Oil Filter.....	HC-7940	930 (CONSTRUCTION & MINING) PERKINS 4.236	
Hydraulic Oil Filter.....	H-2719	ROBEX 210LC-3 (EXCAVATORS) CUMMINS 6BT5.9		Hydraulic Oil Filter.....	HC-7905
Hydraulic Oil Filter.....	H-5609	Hydraulic Oil Filter.....	H-2719	940 (CONSTRUCTION & MINING) PERKINS 4.236	
R450LC-7 (EXCAVATORS) CUMMINS QSM11-C , 2005-UP		Hydraulic Oil Filter.....	HC-7940	Hydraulic Oil Filter.....	HC-7905
Hydraulic Oil Filter.....	HC-7940	ROBEX 210LC-7 (EXCAVATORS) CUMMINS B5.9 , 2005-UP		DA30 (AIR COMPRESSORS) DEUTZ F2L912	
Hydraulic Oil Filter.....	H-2719	Hydraulic Oil Filter.....	H-2719	Hydraulic Oil Filter.....	HC-19040
R450LC-7A (EXCAVATORS) 2006-UP		Hydraulic Oil Filter.....	HC-7940	Hydraulic Oil Filter.....	HC-1903
Hydraulic Oil Filter.....	H-2719	ROBEX 280LC (EXCAVATORS) CUMMINS 6CT8.3		DD23 (AIR COMPRESSORS) KHD F2L511	
Hydraulic Oil Filter.....	HC-7940	Hydraulic Oil Filter.....	H-2725	Hydraulic Oil Filter.....	HC-7906
R450LC (EXCAVATORS) KOMATSU S6D125		Hydraulic Oil Filter.....	H-2719	DD70 (AIR COMPRESSORS) CUMMINS 4B3.9	
Hydraulic Oil Filter.....	H-5609	ROBEX 290LC (EXCAVATORS) CUMMINS 6CT8.3		Hydraulic Oil Filter.....	HC-5504
R500LC-7 (EXCAVATORS) 2006-UP		Hydraulic Oil Filter.....	H-2719	DD90 (AIR COMPRESSORS) CUMMINS 4B3.9	
Hydraulic Oil Filter.....	HC-7940	Hydraulic Oil Filter.....	HC-7940	Hydraulic Oil Filter.....	HC-57030
Hydraulic Oil Filter.....	H-2719	ROBEX 290LC-3LR (EXCAVATORS) CUMMINS 6CT8.3		DM225 (DRILLING) DETROIT 6V-71	
R500LC-7A (EXCAVATORS) 2006-UP		Hydraulic Oil Filter.....	HC-7940	Hydraulic Oil Filter.....	H-5517
Hydraulic Oil Filter.....	HC-7940	Hydraulic Oil Filter.....	H-2719	DM255 (DRILLING) DETROIT 6V-71	
Hydraulic Oil Filter.....	H-2719	ROBEX 420LC (EXCAVATORS) KOMATSU S6D125		Hydraulic Oil Filter.....	H-5517
R55-3 (EXCAVATORS) YANMAR , 2006-UP		Hydraulic Oil Filter.....	H-5609	DM 45HP (DRILLING) CUMMINS	
Hydraulic Oil Filter.....	H-2719	ROBEX 450LC-3 (EXCAVATORS) CUMMINS LTA10		Hydraulic Oil Filter.....	H-7985
R55-7 (EXCAVATORS) 2006-UP		Hydraulic Oil Filter.....	H-2719	DM45 (DRILLING) CUMMINS	
Hydraulic Oil Filter.....	H-2719	INTERNATIONAL HARVESTER		Hydraulic Oil Filter.....	H-57030
R55W-3 (EXCAVATORS) 2006-UP		(ENGINES) IHC U-450		Hydraulic Oil Filter.....	H-7985
Hydraulic Oil Filter.....	H-2719	Hydraulic Oil Filter.....	H-5405	DM45 (DRILLING) CUMMINS	
R80-7 (EXCAVATORS) 2006-UP		(ENGINES) IHC U-501		Hydraulic Oil Filter.....	H-7985
Hydraulic Oil Filter.....	H-2719	Hydraulic Oil Filter.....	H-5405	Hydraulic Oil Filter.....	H-57030
R95W-3 (EXCAVATORS) MITSUBISHI		(ENGINES) IHC UR-450		ECM350 (AIR COMPRESSORS)	
Hydraulic Oil Filter.....	H-2719	Hydraulic Oil Filter.....	H-5405	Hydraulic Oil Filter.....	HC-5503
ROBEX 130LC (EXCAVATORS) CUMMINS 4BTA3.9		(ENGINES) IHC U-501		Hydraulic Oil Filter.....	HC-5503
Hydraulic Oil Filter.....	HC-7940	Hydraulic Oil Filter.....	H-5405	ECM370 (AIR COMPRESSORS) CUMMINS	
Hydraulic Oil Filter.....	H-2719	IHI		Hydraulic Oil Filter.....	HC-5503
ROBEX 130W (EXCAVATORS) CUMMINS		100NS (EXCAVATORS)			
Hydraulic Oil Filter.....	HC-54040	Hydraulic Oil Filter.....	HC-54040		



ENGINE APPLICATION

MODEL/APPLICATION	SAKURA NO	MODEL/APPLICATION	SAKURA NO	MODEL/APPLICATION	SAKURA NO
INGERSOLL RAND		INGERSOLL RAND		INTERNATIONAL TRUCKS	
ECM660 (AIR COMPRESSORS) CUMMINS		Hydraulic Oil Filter.....	HC-57030	Hydraulic Oil Filter Transmission..	H-8537-S
Hydraulic Oil Filter.....	HC-6901	SD100 (COMPACTORS) S/N: 181926-UP		Hydraulic Oil Filter Transmission....	H-8538
Hydraulic Oil Filter.....	H-7914	Hydraulic Oil Filter.....	HC-57020	7400 WORKSTAR (TRUCKS) MAXX FORCE 10	
ECM660 III (AIR COMPRESSORS) CUMMINS , 2008-UP		SD1100 (COMPACTORS) CUMMINS 685.9		Hydraulic Oil Filter Transmission..	H-8537-S
Hydraulic Oil Filter.....	HC-6901	Hydraulic Oil Filter.....	HC-57030	Hydraulic Oil Filter Transmission....	H-8538
ECM660 III (AIR COMPRESSORS) CUMMINS , 2008		SD1700 (AIR COMPRESSORS) CUMMINS 6CT8.3 , 1987-2001		7500 WORKSTAR (TRUCKS) MAXX FORCE DT	
Hydraulic Oil Filter.....	H-7914	Hydraulic Oil Filter.....	HC-57030	Hydraulic Oil Filter Transmission..	H-8537-S
ECM680 (AIR COMPRESSORS)		SD700 (COMPACTORS) CUMMINS 4BT3.9		Hydraulic Oil Filter Transmission....	H-8538
Hydraulic Oil Filter.....	HC-5503	Hydraulic Oil Filter.....	HC-57030	8100 SERIES (BUSES)	
NIRVANA 55 (AIR COMPRESSORS) INGERSOL (S/N: TO 50180)		SP100 (AIR COMPRESSORS) 1987-2001		Hydraulic Oil Filter Power steering..	H-71160
Hydraulic Oil Filter.....	HC-6802	Hydraulic Oil Filter.....	HC-6901	Hydraulic Oil Filter Power steering..	H-71160
NIRVANA 55 (AIR COMPRESSORS)		SSR 1000 (AIR COMPRESSORS)		8600/TRANSTAR (TRUCKS) C10	
Hydraulic Oil Filter.....	HC-6802	Hydraulic Oil Filter.....	HC-6901	Hydraulic Oil Filter.....	HC-5502
P130WD (AIR COMPRESSORS) DEUTZ F3L1011		SSRMH22 (AIR COMPRESSORS) S/N: 2222286-UP		8600/TRANSTAR (TRUCKS) C11	
Hydraulic Oil Filter.....	HC-6901	Hydraulic Oil Filter.....	HC-6802	Hydraulic Oil Filter.....	HC-5502
P130WD (AIR COMPRESSORS) INGERSOL (S/N: TO 50180)		T4BH (AIR COMPRESSORS)		8600/TRANSTAR (TRUCKS) C12	
Hydraulic Oil Filter.....	HC-6901	Hydraulic Oil Filter.....	H-57030	Hydraulic Oil Filter.....	HC-5502
P175W (AIR COMPRESSORS) DEUTZ F3L912		Hydraulic Oil Filter.....	H-7985	8600/TRANSTAR (TRUCKS) C13	
Hydraulic Oil Filter.....	HC-6901	INTERNATIONAL TRUCKS			
P175WD (AIR COMPRESSORS) DEUTZ F3L912		2000 Series (TRUCKS) DT466		Hydraulic Oil Filter Power steering..	H-71160
Hydraulic Oil Filter.....	HC-6901	Hydraulic Oil Filter Power steering..	H-71160	Hydraulic Oil Filter Power steering..	H-71160
P180WD (AIR COMPRESSORS) DEUTZ F4L1011 , 1993		2050 SERIES FLEETSTAR (BUSES) DT466		9200I (TRUCKS) C10	
Hydraulic Oil Filter.....	HC-6901	Hydraulic Oil Filter Power steering..	H-71160	Hydraulic Oil Filter.....	HC-5502
P250BWJD (AIR COMPRESSORS) JDEERE		2050 SERIES FLEETSTAR (BUSES) IHC DT466		9200I (TRUCKS) C11	
Hydraulic Oil Filter.....	HC-6901	Hydraulic Oil Filter Power steering..	H-71160	Hydraulic Oil Filter.....	HC-5502
P250WD (AIR COMPRESSORS) DEUTZ F4L912		2050 SERIES FLEETSTAR (TRUCKS) DT466		9200I (TRUCKS) C12	
Hydraulic Oil Filter.....	HC-6901	Hydraulic Oil Filter Power steering..	H-71160	Hydraulic Oil Filter.....	HC-5502
P70K (AIR COMPRESSORS) KUBOTA D1105-B		2050 SERIES FLEETSTAR (TRUCKS) IHC DT466		9200I (TRUCKS) C13	
Hydraulic Oil Filter.....	HC-6901	Hydraulic Oil Filter Power steering..	H-71160	Hydraulic Oil Filter.....	HC-5502
P70WN (AIR COMPRESSORS) PERKINS 3 CYL		5500I PAYSTAR (TRUCKS) MAXX FORCE 15		9200I (TRUCKS) C15	
Hydraulic Oil Filter.....	HC-6901	Hydraulic Oil Filter Transmission....	H-8538	Hydraulic Oil Filter.....	HC-5502
P750 (AIR COMPRESSORS) PERKINS 3 CYL		Hydraulic Oil Filter Transmission..	H-8537-S	9400 (TRUCKS) NT-855 , 1990-1990	
Hydraulic Oil Filter.....	HC-5503	5900I SBA/PAYSTAR (TRUCKS) ISM		Hydraulic Oil Filter Power steering..	H-71160
SD100 (AIR COMPRESSORS) CUMMINS , 1987-2001		Hydraulic Oil Filter Transmission....	H-8538	9400 (TRUCKS) CUMMINS NT-855 , 1990	
		5900I PAYSTAR (TRUCKS) MAXX FORCE 15		Hydraulic Oil Filter Power steering..	H-71160



ENGINE APPLICATION

MODEL/APPLICATION	SAKURA NO
INTERNATIONAL TRUCKS	
9400 (BUSES)	
Hydraulic Oil Filter Power steering..	H-71160
Hydraulic Oil Filter Power steering..	H-71160
9400I (TRUCKS) C12	
Hydraulic Oil Filter.....	HC-5502
9400I (TRUCKS) C13	
Hydraulic Oil Filter.....	HC-5502
9400I (TRUCKS) C15	
Hydraulic Oil Filter.....	HC-5502
9900I (TRUCKS) C15	
Hydraulic Oil Filter.....	HC-5502
9900IX (TRUCKS) C15	
Hydraulic Oil Filter.....	HC-5502
9900IX (TRUCKS) C16	
Hydraulic Oil Filter.....	HC-5502
CE (TRUCKS) MAXX FORCE 7	
Hydraulic Oil Filter Transmission....	H-8538
Hydraulic Oil Filter Transmission..	H-8537-S
CE (TRUCKS) MAXX FORCE DT	
Hydraulic Oil Filter Transmission..	H-8537-S
Hydraulic Oil Filter Transmission....	H-8538
DURASTAR (TRUCKS) MAXX FORCE 7	
Hydraulic Oil Filter Transmission..	H-8537-S
Hydraulic Oil Filter Transmission....	H-8538
DURASTAR (TRUCKS) MAXX FORCE 9	
Hydraulic Oil Filter Transmission..	H-8537-S
Hydraulic Oil Filter Transmission....	H-8538
DURASTAR (TRUCKS) MAXX FORCE DT	
Hydraulic Oil Filter Transmission....	H-8538
Hydraulic Oil Filter Transmission..	H-8537-S
FE (TRUCKS) MAXX FORCE DT	
Hydraulic Oil Filter Transmission....	H-8538
Hydraulic Oil Filter Transmission..	H-8537-S
HC (TRUCKS) MAXX FORCE 7	
Hydraulic Oil Filter Transmission..	H-8537-S
Hydraulic Oil Filter Transmission....	H-8538
HC (TRUCKS) MAXX FORCE DT	

MODEL/APPLICATION	SAKURA NO
INTERNATIONAL TRUCKS	
Hydraulic Oil Filter Transmission....	H-8538
Hydraulic Oil Filter Transmission..	H-8537-S
RE (TRUCKS) MAXX FORCE DT	
Hydraulic Oil Filter Transmission..	H-8537-S
Hydraulic Oil Filter Transmission....	H-8538
TranStar (TRUCKS) ISM	
Hydraulic Oil Filter Transmission..	H-8537-S
WORKSTAR (TRUCKS) MAXX FORCE DT	
Hydraulic Oil Filter Transmission..	H-8537-S
Hydraulic Oil Filter Transmission....	H-8538
IRISBUS	
AGORA (BUSES) IVECO CURSOR 8 , 2002-2006	
Hydraulic Oil Filter Transmission....	H-7102
AGORA CNG (BUSES) IVECO CURSOR 8 CNG (S/N: F2G-UP) , 2003-2006	
Hydraulic Oil Filter Transmission....	H-7102
ARES N 10.6 (BUSES) IVECO CURSOR 8 , 2002-UP	
Hydraulic Oil Filter Transmission....	H-7102
ARES N 12 (BUSES) IRISBUS DCI 11 (S/N: EURO 3-UP) , 2002-UP	
Hydraulic Oil Filter Transmission....	H-7102
ARWAY 12 (BUSES) IVECO CURSOR 8 (S/N: EURO 4-UP) , 2005-UP	
Hydraulic Oil Filter Transmission....	H-7102
AXER 12 (BUSES) IVECO CURSOR 8 (S/N: F2BE 1682G-UP) , 2002-2007	
Hydraulic Oil Filter Transmission....	H-7102
CITELIS 12 (BUSES) IVECO CURSOR 8 , 2005-UP	
Hydraulic Oil Filter Transmission....	H-7102
CITY BUS E3 (BUSES) IVECO CURSOR 8 (S/N: EURO 3-UP) , 2003-UP	
Hydraulic Oil Filter Transmission....	H-7102
CITYCLASS 10.8 (BUSES) IVECO CURSOR 8 , 2002-UP	
Hydraulic Oil Filter Transmission....	H-7102
CIVIS (BUSES) IVECO CURSOR 8 , 2001-UP	
Hydraulic Oil Filter Transmission....	H-7102
EVADYS H12 (BUSES) IVECO CURSOR 10 , 2004-UP	
Hydraulic Oil Filter Transmission....	H-7102
EVADYS H12 (BUSES) IVECO CURSOR 8 , 2004-UP	
Hydraulic Oil Filter Transmission....	H-7102

MODEL/APPLICATION	SAKURA NO
IRISBUS	
EVADYS HD12 (BUSES) IVECO CURSOR 10 (S/N: EURO 4-UP) , 2006-UP	
Hydraulic Oil Filter Transmission....	H-7102
EVADYS HD12 (BUSES) IVECO CURSOR 10 , 2004-UP	
Hydraulic Oil Filter Transmission....	H-7102
ILIADE H GTC (BUSES) RENAULTT DCI11 (S/N: EURO3-UP) , 2002-2007	
Hydraulic Oil Filter Transmission....	H-7102
IRIS (BUSES) IVECO CURSOR , 2002-UP	
Hydraulic Oil Filter Transmission....	H-7102
MOOVY (BUSES) IVECO CURSOR 8-F2B , 2004-UP	
Hydraulic Oil Filter Transmission....	H-7102
ISEKI	
SF300 (TRACTORS)	
Hydraulic Oil Filter.....	HC-8805
SG153H (RIDING MOWER) 3 CYLINDER, WATER COOLED , 600	
Hydraulic Oil Filter.....	HC-47020
SG173H (RIDING MOWER) 3 CYLINDER, WATER COOLED , 700	
Hydraulic Oil Filter.....	HC-47020
TA525 (TRACTORS)	
Hydraulic Oil Filter.....	HC-8805
TM217 (TRACTORS)	
Hydraulic Oil Filter.....	HC-8805
ISUZU	
FTR (TRUCKS) ISUZU 6HK1TC , 1998-2007	
Hydraulic Oil Filter Transmission..	H-8537-S
Hydraulic Oil Filter Transmission....	H-8538
FVR (TRUCKS) ISUZU 6HK1TC , 1998-2007	
Hydraulic Oil Filter Transmission....	H-8538
Hydraulic Oil Filter Transmission..	H-8537-S
FXR (TRUCKS) ISUZU 6HK1TC , 1998-2007	
Hydraulic Oil Filter Transmission..	H-8537-S
Hydraulic Oil Filter Transmission....	H-8538
HTR (TRUCKS) ISUZU 6HK1TC	
Hydraulic Oil Filter Transmission..	H-8537-S
Hydraulic Oil Filter Transmission....	H-8538
HVR (TRUCKS) ISUZU 6HK1TC	
Hydraulic Oil Filter Transmission....	H-8538



ENGINE APPLICATION

MODEL/APPLICATION	SAKURA NO	MODEL/APPLICATION	SAKURA NO	MODEL/APPLICATION	SAKURA NO
ISUZU		IVECO		J. C. BAMFORD	
HVR (TRUCKS) ISUZU 6HK1TC Hydraulic Oil Filter Transmission... H-8537-S		STRALIS ACTIVE TIME 400 (TRUCKS) IVECO CURSOR 10 , 2003-UP Hydraulic Oil Filter Transmission.... H-7102		1CX HF (LOADERS) PERKINS 104-22 Hydraulic Oil Filter..... HC-76080	
HXR (TRUCKS) ISUZU 6HK1TC Hydraulic Oil Filter Transmission.... H-8538 Hydraulic Oil Filter Transmission.. H-8537-S		STRALIS ACTIVE TIME 420 (TRUCKS) IVECO CURSOR 10 , 2006-UP Hydraulic Oil Filter Transmission.... H-7102		1CX HF (LOADERS) PERKINS 404C-22 Hydraulic Oil Filter..... HC-76080	
IVECO		STRALIS EXECUTIVE SPACE 480 (TRUCKS) IVECO CURSOR 13 (S/N: 190S48-UP) , 2004-UP Hydraulic Oil Filter Transmission.... H-7102		1CX HF (LOADERS) PERKINS 404D-22 (S/N: TIER 3-UP) Hydraulic Oil Filter..... HC-76080	
180E39 EUROTECH (TRUCKS) IVECO CURSOR 10 , 1999-UP Hydraulic Oil Filter Transmission.... H-7102		STRALIS EXECUTIVE SPACE 480 (TRUCKS) IVECO CURSOR 13 (S/N: 260S48-UP) , 2004-UP Hydraulic Oil Filter Transmission.... H-7102		208S (LOADERS) S/N: 727001-751599 Hydraulic Oil Filter..... HC-5508	
440E39 EUROSTAR (TRUCKS) IVECO CURSOR 10 , 1999-UP Hydraulic Oil Filter Transmission.... H-7102		STRALIS EXECUTIVE SPACE 480 (TRUCKS) IVECO CURSOR 13 (S/N: 440S48-UP) , 2004-UP Hydraulic Oil Filter Transmission.... H-7102		208S (LOADERS) S/N: 751600-UP Hydraulic Oil Filter..... HC-5508	
EuroClass (BUSES) IVECO CURSOR 8 , 2002-UP Hydraulic Oil Filter Transmission.... H-7102		STRALIS EXECUTIVE SPACE 500 (TRUCKS) IVECO CURSOR 13 (S/N: 190S50-UP) , 2006-UP Hydraulic Oil Filter Transmission.... H-7102		208S HF (LOADERS) S/N: 727001-751599 Hydraulic Oil Filter..... HC-76080	
EuroClass (BUSES) RENAULT 11 DCI , 2002-UP Hydraulic Oil Filter Transmission.... H-7102		STRALIS EXECUTIVE SPACE 500 (TRUCKS) IVECO CURSOR 13 (S/N: 260S50-UP) , 2006-UP Hydraulic Oil Filter Transmission.... H-7102		208S HF (LOADERS) S/N: 751600-UP Hydraulic Oil Filter..... HC-76080	
EURORIDER 397E.12.35 (BUSES) IVECO CURSOR 8 , 2002-UP Hydraulic Oil Filter Transmission.... H-7102		STRALIS EXECUTIVE SPACE 500 (TRUCKS) IVECO CURSOR 13 (S/N: 440S50-UP) , 2006-UP Hydraulic Oil Filter Transmission.... H-7102		210 (LOADERS) PERKINS Hydraulic Oil Filter..... HC-76080	
STRALIS ACTIVE DAY 270 (TRUCKS) IVECO CURSOR 8 , 2003-UP Hydraulic Oil Filter Transmission.... H-7102		STRALIS EXECUTIVE SPACE 540 (TRUCKS) IVECO CURSOR 13 (S/N: 260S54-UP) , 2004-UP Hydraulic Oil Filter Transmission.... H-7102		210S (LOADERS) PERKINS 1004.4 Hydraulic Oil Filter..... HC-76080	
STRALIS ACTIVE DAY 330 (TRUCKS) IVECO CURSOR 8 , 2006-UP Hydraulic Oil Filter Transmission.... H-7102		STRALIS EXECUTIVE SPACE 540 (TRUCKS) IVECO CURSOR 13 (S/N: 440S54-UP) , 2004-UP Hydraulic Oil Filter Transmission.... H-7102		210SLSU (LOADERS) Hydraulic Oil Filter..... HC-76080	
STRALIS ACTIVE DAY 400 (TRUCKS) IVECO CURSOR 10 , 2003-UP Hydraulic Oil Filter Transmission.... H-7102		STRALIS EXECUTIVE SPACE 560 (TRUCKS) IVECO CURSOR 13 (S/N: 260S56-UP) , 2006-UP Hydraulic Oil Filter Transmission.... H-7102		212S (LOADERS) PERKINS Hydraulic Oil Filter..... HC-76080	
STRALIS ACTIVE DAY 420 (TRUCKS) IVECO CURSOR 10 , 2006-UP Hydraulic Oil Filter Transmission.... H-7102		STRALIS EXECUTIVE SPACE 560 (TRUCKS) IVECO CURSOR 13 (S/N: 440S56-UP) , 2006-UP Hydraulic Oil Filter Transmission.... H-7102		2CX (LOADERS) JCBAMFORD 444 (S/N: DIESELMAX-UP) , 2006-UP Hydraulic Oil Filter..... HC-8501	
STRALIS ACTIVE SPACE 420 (TRUCKS) IVECO CURSOR 10 , 2006-UP Hydraulic Oil Filter Transmission.... H-7102		J. C. BAMFORD		2CX (LOADERS) PERKINS 3.152 , 1993 Hydraulic Oil Filter..... HC-76080	
STRALIS ACTIVE SPACE 480 (TRUCKS) IVECO CURSOR 13 , 2002-UP Hydraulic Oil Filter Transmission.... H-7102		1CX (LOADERS) 1992-UP Hydraulic Oil Filter..... HC-5508		2CXL (LOADERS) 1993 Hydraulic Oil Filter..... HC-76080	
STRALIS ACTIVE SPACE 500 (TRUCKS) IVECO CURSOR 13 , 2006-UP Hydraulic Oil Filter Transmission.... H-7102		1CX (LOADERS) PERKINS 104-22 Hydraulic Oil Filter..... HC-5508		3CX TURBO (LOADERS) PERKINS T4.236 Hydraulic Oil Filter..... H-7973	
STRALIS ACTIVE TIME 270 (TRUCKS) IVECO CURSOR 8 , 2003-UP Hydraulic Oil Filter Transmission.... H-7102		1CX (LOADERS) PERKINS 404C-22 Hydraulic Oil Filter..... HC-5508		3CX (LOADERS) 2007-UP Hydraulic Oil Filter..... HC-8501	
STRALIS ACTIVE TIME 330 (TRUCKS) IVECO CURSOR 8 , 2006-UP Hydraulic Oil Filter Transmission.... H-7102		1CX (LOADERS) PERKINS 404D-22 (S/N: TIER 3-UP) Hydraulic Oil Filter..... HC-5508		3CX (LOADERS) LEYLAND 4.98T Hydraulic Oil Filter..... H-7973	



ENGINE APPLICATION

MODEL/APPLICATION	SAKURA NO	MODEL/APPLICATION	SAKURA NO	MODEL/APPLICATION	SAKURA NO
J. C. BAMFORD		J. C. BAMFORD		J. C. BAMFORD	
3CX (LOADERS) LEYLAND 4.98TT Hydraulic Oil Filter.....	H-7973	Hydraulic Oil Filter.....	H-51050	436 AGRI (LOADERS) CUMMINS QSB6.7 Hydraulic Oil Filter.....	H-7922
3CX (LOADERS) PERKINS Hydraulic Oil Filter.....	H-7973	425 (LOADERS) PERKINS 1006.6 , 1987-UP Hydraulic Oil Filter.....	H-7973	436B (LOADERS) 2002-UP Hydraulic Oil Filter.....	HC-76110
3CX TLB (LOADERS) 1998-UP Hydraulic Oil Filter.....	HC-8501	425 (CONSTRUCTION & MINING) 425 Hydraulic Oil Filter.....	H-7973	436BHT (LOADERS) 1998-UP Hydraulic Oil Filter Transmission... Hydraulic Oil Filter.....	HC-2701 H-7922
3CX SUPER (LOADERS) JCBAMFORD 444 (S/N: DIESELMAX-UP) , 2006-UP Hydraulic Oil Filter.....	HC-8501	426 (LOADERS) 2002-UP Hydraulic Oil Filter..... Hydraulic Oil Filter.....	H-7922 HC-76110	436HT (LOADERS) CUMMINS BTAAS.9C (S/N: TIER2-UP) , 2007-UP Hydraulic Oil Filter.....	H-7922
406 (CONSTRUCTION & MINING) PERKINS D3.152 Hydraulic Oil Filter.....	HC-7906	426 (CONSTRUCTION & MINING) 2002 Hydraulic Oil Filter.....	H-7922	456 AGRI (LOADERS) Hydraulic Oil Filter.....	H-7922
406 (LOADERS) Hydraulic Oil Filter.....	HC-76080	426 HT (LOADERS) CUMMINS BTAAS.9C , 2008-UP Hydraulic Oil Filter.....	H-7922	456HT (LOADERS) CUMMINS 6CT8.3C (S/N: TIER 2-UP) , 2004-UP Hydraulic Oil Filter.....	H-7922
406 (LOADERS) PERKINS D3.152 Hydraulic Oil Filter.....	HC-7906	426 HT (LOADERS) PERKINS 1006-60T , 2002-UP Hydraulic Oil Filter..... Hydraulic Oil Filter.....	HC-76110 H-7922	456B (LOADERS) Hydraulic Oil Filter Transmission... Hydraulic Oil Filter.....	HC-2701 H-7922
407 (CONSTRUCTION & MINING) 1993 Hydraulic Oil Filter.....	HC-7905	426B (LOADERS) 2002-UP Hydraulic Oil Filter..... Hydraulic Oil Filter.....	H-7922 HC-76110	4CX TURBO (LOADERS) PERKINS 1000 SERIES , 1990-UP Hydraulic Oil Filter.....	H-7973
408 (LOADERS) 1989-UP Hydraulic Oil Filter.....	HC-76080	426 AGRI (LOADERS) CUMMINS QSB6.7 (S/N: TIER3-UP) Hydraulic Oil Filter.....	H-7922	4CX TURBO (LOADERS) PERKINS Hydraulic Oil Filter.....	H-7973
409 (LOADERS) PERKINS , 1993 Hydraulic Oil Filter.....	HC-76080	434S (LOADERS) CUMMINS QSB6.7 , 2006-UP Hydraulic Oil Filter.....	H-7922	4CX SUPER (LOADERS) 2007-UP Hydraulic Oil Filter.....	HC-8501
410 (LOADERS) LEYLAND 4.98 Hydraulic Oil Filter.....	HC-7913	435 (CONSTRUCTION & MINING) 1993 Hydraulic Oil Filter..... Hydraulic Oil Filter.....	H-7973 H-7922	505-19 (HANDLER TELESCOPIC) S/N: 561011-567216 Hydraulic Oil Filter.....	HC-7906
410 (LOADERS) PERKINS 4.236 Hydraulic Oil Filter.....	HC-7913	435 (LOADERS) PERKINS , 1993 Hydraulic Oil Filter..... Hydraulic Oil Filter.....	H-7922 H-7973	505-22 (HANDLER TELESCOPIC) S/N: 561011-567216 Hydraulic Oil Filter.....	HC-7906
411 (LOADERS) 1993 Hydraulic Oil Filter.....	H-51050	435 (CONSTRUCTION & MINING) 435 Hydraulic Oil Filter..... Hydraulic Oil Filter.....	H-7973 H-7922	506-36 (HANDLER TELESCOPIC) S/N: 561011-567216 Hydraulic Oil Filter.....	HC-7906
411B (LOADERS) 1998-UP Hydraulic Oil Filter.....	H-51050	436 (LOADERS) PERKINS 1006-60TW , 2002-UP Hydraulic Oil Filter..... Hydraulic Oil Filter Transmission... Hydraulic Oil Filter.....	H-7922 HC-2701	508-10 (HANDLER TELESCOPIC) S/N: 561011-564528 Hydraulic Oil Filter.....	HC-7906
412E (LOADERS) PERKINS , 1993 Hydraulic Oil Filter..... Hydraulic Oil Filter.....	H-7973 HC-7913	436 (CONSTRUCTION & MINING) Hydraulic Oil Filter Transmission... Hydraulic Oil Filter.....	HC-2701	508-40 LOADALL (HANDLER TELESCOPIC) Hydraulic Oil Filter.....	HC-7906
416 (LOADERS) 1993 Hydraulic Oil Filter.....	H-51050				
416B (LOADERS) PERKINS , 2002-UP					



ENGINE APPLICATION

MODEL/APPLICATION	SAKURA NO	MODEL/APPLICATION	SAKURA NO	MODEL/APPLICATION	SAKURA NO
J. C. BAMFORD		J. C. BAMFORD		J. C. BAMFORD	
510-40 (HANDLER TELESCOPIC) S/N: 561011-564528		535-95 TELEBAT (HANDLER TELESCOPIC) PERKINS , 2000-UP		930 (FORKLIFTS) S/N: 662023-TBA	
Hydraulic Oil Filter.....	HC-7906	Hydraulic Oil Filter.....	HC-8501	Hydraulic Oil Filter.....	HC-7906
520-50 TELEBAT (HANDLER TELESCOPIC) PERKINS , 1998-UP		536-60 (HANDLER TELESCOPIC) JCBAMFORD 444 (S/N: DIESELMAX TIER2-UP) ,		930 (FORKLIFTS) S/N: 908723-609999	
Hydraulic Oil Filter.....	HC-8501	Hydraulic Oil Filter.....	HC-8501	Hydraulic Oil Filter.....	HC-7906
525-58 FARM SPECIAL (CONSTRUCTION & MINING) J.C.BAMFORDAMFOR TURBO , 1992		712 (DUMPERS) S/N: 612001-ON , 1988-UP		930 (FORKLIFTS) S/N: EU7175256A-662022	
Hydraulic Oil Filter.....	HC-7905	Hydraulic Oil Filter.....	H-7973	Hydraulic Oil Filter.....	HC-7906
		Hydraulic Oil Filter.....	HC-7913		
525-67 (CONSTRUCTION & MINING) PERKINS 1004.4		803 (LOADERS) 1993		930 (FORKLIFTS) S/N: TBA-ON	
Hydraulic Oil Filter.....	HC-7905	Hydraulic Oil Filter.....	H-51050	Hydraulic Oil Filter.....	HC-7906
525-58 (HANDLER TELESCOPIC) PERKINS		803 (LOADERS) S/N: 865607-ON		940 (CONSTRUCTION & MINING) PERKINS 4.236	
Hydraulic Oil Filter.....	HC-7906	Hydraulic Oil Filter.....	H-51050	Hydraulic Oil Filter.....	HC-7906
528-70 TELEBAT (HANDLER TELESCOPIC)		804 (LOADERS) S/N: 734402-ON , 1998-UP		940 (FORKLIFTS) S/N: 660033-660299	
Hydraulic Oil Filter.....	HC-8501	Hydraulic Oil Filter.....	H-51050	Hydraulic Oil Filter.....	HC-7906
528S (HANDLER TELESCOPIC)		926 (CONSTRUCTION & MINING) PERKINS 4.236		940 (FORKLIFTS) S/N: 660300-EU17525A	
Hydraulic Oil Filter.....	HC-8501	Hydraulic Oil Filter.....	HC-7906	Hydraulic Oil Filter.....	HC-7906
530 (CONSTRUCTION & MINING) PERKINS PERKINS		926 (FORKLIFTS) S/N: 602902-605999		940 (FORKLIFTS) S/N: 662023-UP	
Hydraulic Oil Filter.....	HC-7905	Hydraulic Oil Filter.....	HC-7906	Hydraulic Oil Filter.....	HC-7906
530-120 (CONSTRUCTION & MINING) J.C.BAMFORDAMFOR AA BUILD , 1993		926 (FORKLIFTS) S/N: 660300-EU17525A		940 (FORKLIFTS) S/N: EU7175256A-662022	
Hydraulic Oil Filter.....	HC-7905	Hydraulic Oil Filter.....	HC-7906	Hydraulic Oil Filter.....	HC-7906
530-120 TURBO (CONSTRUCTION & MINING) J.C.BAMFORDAMFOR TURBO , 1993		926 (FORKLIFTS) S/N: 662023-TBA		FASTRAC - 3200 (LOADERS) CUMMINS QS86.7	
Hydraulic Oil Filter.....	HC-7905	Hydraulic Oil Filter.....	HC-7906	Hydraulic Oil Filter.....	HC-5508
530-B4 (CONSTRUCTION & MINING) PERKINS T4.236		926 (FORKLIFTS) S/N: EU7175256A-662022		FASTRAC 1115 (LOADERS) PERKINS 1006.6 (S/N: 736000-UP)	
Hydraulic Oil Filter.....	HC-7905	Hydraulic Oil Filter.....	HC-7906	Hydraulic Oil Filter.....	HC-5508
530HL (HANDLER TELESCOPIC)		926 (FORKLIFTS) S/N: TBA-ON		Hydraulic Oil Filter.....	H-51050
Hydraulic Oil Filter.....	HC-7906	Hydraulic Oil Filter.....	HC-7906	FASTRAC 1125 (LOADERS) PERKINS 1006.6	
533-105 (HANDLER TELESCOPIC) PERKINS , 2004-UP		930 (CONSTRUCTION & MINING) PERKINS 4.236		Hydraulic Oil Filter.....	HC-5508
Hydraulic Oil Filter.....	HC-8501	Hydraulic Oil Filter.....	HC-7906	Hydraulic Oil Filter.....	H-51050
533-105B (HANDLER TELESCOPIC) PERKINS , 2004-UP		930 (FORKLIFTS)		FASTRAC 1135 (LOADERS) S/N: 736000-UP	
Hydraulic Oil Filter.....	HC-8501	Hydraulic Oil Filter.....	HC-7906	Hydraulic Oil Filter.....	HC-5508
533-105T TELEBAT (HANDLER TELESCOPIC) PERKINS TURBO , 2004-UP		930 (FORKLIFTS) S/N: 608300-608722		Hydraulic Oil Filter.....	H-51050
Hydraulic Oil Filter.....	HC-8501	Hydraulic Oil Filter.....	HC-7906	FASTRAC 1135 (LOADERS) S/N: TBA-ON	
535-95CD TELEBAT (HANDLER TELESCOPIC) PERKINS , 2004-UP		930 (FORKLIFTS) S/N: 660300-EU717525A		Hydraulic Oil Filter.....	HC-5508
Hydraulic Oil Filter.....	HC-8501	Hydraulic Oil Filter.....	HC-7906	Hydraulic Oil Filter.....	H-51050
535-95CD TELEBAT (FORKLIFTS) PERKINS PERKINS , 2004					
Hydraulic Oil Filter.....	HC-7905				



ENGINE APPLICATION

MODEL/APPLICATION	SAKURA NO	MODEL/APPLICATION	SAKURA NO	MODEL/APPLICATION	SAKURA NO
J. C. BAMFORD		J. C. BAMFORD		J. C. BAMFORD	
FASTRAC 1135 (LOADERS) S/N: T0-737114		FASTRAC 3155 (LOADERS) PERKINS 1006.6TA , 1998-UP		Hydraulic Oil Filter.....	HC-8805
Hydraulic Oil Filter.....	H-51050	Hydraulic Oil Filter.....	H-51050	JS145W (EXCAVATORS)	
Hydraulic Oil Filter.....	HC-5508	Hydraulic Oil Filter.....	HC-5508	Hydraulic Oil Filter.....	H-5519
FASTRAC 125 (LOADERS) S/N: 635001-635994		FASTRAC 3185 (LOADERS) CUMMINS 6BTA5.9 , 1998-UP		JS150 (EXCAVATORS)	
Hydraulic Oil Filter.....	H-51050	Hydraulic Oil Filter.....	H-51050	Hydraulic Oil Filter.....	H-5519
FASTRAC 125 (LOADERS) S/N: 636001-UP		Hydraulic Oil Filter.....	HC-5508	JS150 (SHOVELS) ISUZU	
Hydraulic Oil Filter.....	H-51050	FASTRAC 3185 (LOADERS) S/N: 640001-ON		Hydraulic Oil Filter.....	HC-8805
Hydraulic Oil Filter.....	HC-5508	Hydraulic Oil Filter.....	HC-5508	Hydraulic Oil Filter.....	H-2719
FASTRAC 130T (LOADERS) PERKINS 1006-6T (S/N: 635001-635994)		Hydraulic Oil Filter.....	H-51050	JS150LC (EXCAVATORS)	
Hydraulic Oil Filter.....	H-51050	JC200LC (EXCAVATORS) JCBAMFORD S/N M704002 ON (S/N: M704002-UP)		Hydraulic Oil Filter.....	H-5519
FASTRAC 135T (LOADERS) S/N: 636001-UP		Hydraulic Oil Filter.....	H-5609	JS150W (EXCAVATORS)	
Hydraulic Oil Filter.....	HC-5508	JS110 (SHOVELS) ISUZU , 1990-UP		Hydraulic Oil Filter.....	H-5519
Hydraulic Oil Filter.....	H-51050	Hydraulic Oil Filter.....	H-2719	JS160 (EXCAVATORS) ISUZU	
FASTRAC 145T-40 (LOADERS) S/N: 635001-635994		Hydraulic Oil Filter.....	HC-8805	Hydraulic Oil Filter.....	HC-8805
Hydraulic Oil Filter.....	H-51050	JS110 (EXCAVATORS)		Hydraulic Oil Filter.....	H-2719
FASTRAC 150T (LOADERS) S/N: 636001-UP		Hydraulic Oil Filter.....	H-5519	JS160 (EXCAVATORS)	
Hydraulic Oil Filter.....	HC-5508	JS130 (EXCAVATORS)		Hydraulic Oil Filter.....	H-5519
Hydraulic Oil Filter.....	H-51050	Hydraulic Oil Filter.....	H-5519	JS160W (EXCAVATORS)	
FASTRAC 155 (LOADERS) S/N: 736000-ON		JS130W (SHOVELS) ISUZU 6BG1 , 2001-UP		Hydraulic Oil Filter.....	H-5519
Hydraulic Oil Filter.....	HC-5508	Hydraulic Oil Filter.....	HC-8805	JS160W (SHOVELS) S/N: 718636-UP	
Hydraulic Oil Filter.....	H-51050	Hydraulic Oil Filter.....	H-5107	Hydraulic Oil Filter.....	H-2719
FASTRAC 185 (LOADERS) S/N: 636001-UP		Hydraulic Oil Filter.....	H-2719	Hydraulic Oil Filter.....	HC-8805
Hydraulic Oil Filter.....	H-51050	JS130W (SHOVELS) ISUZU , 1993-UP		JS180 (EXCAVATORS)	
Hydraulic Oil Filter.....	HC-5508	Hydraulic Oil Filter.....	HC-8805	Hydraulic Oil Filter.....	H-5519
FASTRAC 185T (LOADERS) S/N: 636001-UP		Hydraulic Oil Filter.....	H-5107	JS115 (EXCAVATORS)	
Hydraulic Oil Filter.....	H-51050	Hydraulic Oil Filter.....	H-2719	Hydraulic Oil Filter.....	H-5519
Hydraulic Oil Filter.....	HC-5508	JS130W (EXCAVATORS)		JS130LC (EXCAVATORS)	
FASTRAC 2115 (LOADERS) 1998-UP		Hydraulic Oil Filter.....	H-5519	Hydraulic Oil Filter.....	H-5519
Hydraulic Oil Filter.....	HC-5508	JS130W (SHOVELS) S/N: 716917/716700-UP		JS175W (EXCAVATORS)	
Hydraulic Oil Filter.....	H-51050	Hydraulic Oil Filter.....	H-2719	Hydraulic Oil Filter.....	H-5519
FASTRAC 2115 (LOADERS) S/N: 738001-ON		Hydraulic Oil Filter.....	HC-8805	JS190 (EXCAVATORS)	
Hydraulic Oil Filter.....	H-51050	JS145 (EXCAVATORS)		Hydraulic Oil Filter.....	H-5519
Hydraulic Oil Filter.....	HC-5508	Hydraulic Oil Filter.....	H-5519	JS200 (SHOVELS) ISUZU	
FASTRAC 2150 (LOADERS) PERKINS 1006.6TW , 1998-UP		JS145W (SHOVELS) ISUZU A-4BG1 , 2001-2004		Hydraulic Oil Filter.....	H-5519
Hydraulic Oil Filter.....	HC-5508	Hydraulic Oil Filter.....	H-2719	Hydraulic Oil Filter.....	HC-8805
Hydraulic Oil Filter.....	H-51050	Hydraulic Oil Filter.....	H-5107	Hydraulic Oil Filter.....	H-5609
FASTRAC 2155 (LOADERS) CUMMINS QSB6.7 , 2007-UP		Hydraulic Oil Filter.....	HC-8805	Hydraulic Oil Filter.....	H-2719
Hydraulic Oil Filter.....	HC-5508	JS145W (EXCAVATORS) ISUZU 4BG1T (S/N: TIER2-UP)			



ENGINE APPLICATION

MODEL/APPLICATION	SAKURA NO	MODEL/APPLICATION	SAKURA NO	MODEL/APPLICATION	SAKURA NO
J. C. BAMFORD		J. C. BAMFORD		J. C. BAMFORD	
JS200L (EXCAVATORS) ISUZU 6BG1T		JS70 (SHOVELS) ISUZU 4JB1 PAA-04 (S/N: 695501-UP) , 1990-UP		ROBOT 165 (LOADERS) S/N: 675006-676799	
Hydraulic Oil Filter.....	H-7973	Hydraulic Oil Filter.....	H-2719	Hydraulic Oil Filter.....	HC-5508
JS210 (SHOVELS) 2000-UP		JZ140 (EXCAVATORS)		ROBOT 165 (LOADERS) S/N: 677001-677999	
Hydraulic Oil Filter.....	H-2719	Hydraulic Oil Filter.....	H-5519	Hydraulic Oil Filter.....	HC-5508
JS220LC (SHOVELS) ISUZU 6BG1TRB-05 , 2005-UP		JZ255LC (EXCAVATORS) ISUZU		ROBOT 165 (LOADERS) S/N: 678002-0N	
Hydraulic Oil Filter.....	HC-8805	Hydraulic Oil Filter.....	H-5001	Hydraulic Oil Filter.....	HC-5508
JS220LC (SHOVELS) ISUZU 6BG1T , 1997-UP		MIDI CX (BACKHOE LOADERS) PERKINS 404C-22 , 2007-UP		ROBOT 170 (LOADERS) PERKINS 404C-22 (S/N: TIER2-UP)	
Hydraulic Oil Filter.....	H-2719	Hydraulic Oil Filter.....	HC-5508	Hydraulic Oil Filter.....	HC-5508
Hydraulic Oil Filter.....	HC-8805	MIDI CX (BACKHOE LOADERS) PERKINS 404D-22 (S/N: TIER 3-UP) , 2007-UP		ROBOT 170 (LOADERS) PERKINS 404C-22T (S/N: TIER2-UP)	
JS240 (SHOVELS) S/N: 708540-UP		Hydraulic Oil Filter.....	HC-5508	Hydraulic Oil Filter.....	HC-5508
Hydraulic Oil Filter.....	HC-8805	ROBOT 1110 (LOADERS) JCBAMFORD 444 (S/N: DIESELMAX-UP)		ROBOT 170 (LOADERS) PERKINS 404D-22 (S/N: TIER 3-UP)	
Hydraulic Oil Filter.....	H-2719	Hydraulic Oil Filter.....	HC-5508	Hydraulic Oil Filter.....	HC-5508
Hydraulic Oil Filter.....	H-5001	ROBOT 1110 (LOADERS) PERKINS 1004.4		ROBOT 170 (LOADERS) PERKINS 404D-22T (S/N: TIER3-UP)	
JS240L (EXCAVATORS) ISUZU 6BG1T		Hydraulic Oil Filter.....	HC-5508	Hydraulic Oil Filter.....	HC-5508
Hydraulic Oil Filter.....	H-7973	ROBOT 1110 (LOADERS) PERKINS 1004.4T		ROBOT 180 (LOADERS) PERKINS 404C-22	
JS240LC (SHOVELS) JCBAMFORD (S/N: M708002-UP) , 1990-UP		Hydraulic Oil Filter.....	HC-5508	Hydraulic Oil Filter.....	HC-5508
Hydraulic Oil Filter.....	H-2719	ROBOT 1110 (LOADERS) PERKINS 1104C-44		ROBOT 180 (LOADERS) PERKINS 404C-22/T	
Hydraulic Oil Filter.....	HC-8805	Hydraulic Oil Filter.....	HC-5508	Hydraulic Oil Filter.....	HC-5508
Hydraulic Oil Filter.....	H-5001	ROBOT 1110 (LOADERS) PERKINS 1104C-44/T		ROBOT 180 (LOADERS) PERKINS 404D-22 (S/N: TIER 3-UP)	
JS260NLC (SHOVELS) ISUZU 6BGI TPC-01		Hydraulic Oil Filter.....	HC-5508	Hydraulic Oil Filter.....	HC-5508
Hydraulic Oil Filter.....	H-5001	ROBOT 150 (LOADERS) PEUGEOT XUD9 , 1993		ROBOT 180 (LOADERS) PERKINS 404D-22T (S/N: TIER3-UP)	
JS300 (SHOVELS) ISUZU		Hydraulic Oil Filter.....	HC-5508	Hydraulic Oil Filter.....	HC-5508
Hydraulic Oil Filter.....	HC-8805	Hydraulic Oil Filter.....	HC-76080	ROBOT 180T (LOADERS) PERKINS 404C-22 (S/N: TIER2-UP)	
Hydraulic Oil Filter.....	H-2719	ROBOT 160 (LOADERS) PERKINS 404C-22 (S/N: TIER2-UP)		Hydraulic Oil Filter.....	HC-5508
JS300LC (SHOVELS) ISUZU 6SDIT PB-01		Hydraulic Oil Filter.....	HC-5508	ROBOT 180T (LOADERS) PERKINS 404C-22T (S/N: TIER2-UP)	
Hydraulic Oil Filter.....	H-2719	ROBOT 160 (LOADERS) PERKINS 404C-22T (S/N: TIER2-UP)		Hydraulic Oil Filter.....	HC-5508
Hydraulic Oil Filter.....	HC-8805	Hydraulic Oil Filter.....	HC-5508	ROBOT 185 (LOADERS) S/N: 746001-0N	
JS330 (SHOVELS)		ROBOT 160 (LOADERS) PERKINS 404D-22 (S/N: TIER 3-UP)		Hydraulic Oil Filter.....	HC-5508
Hydraulic Oil Filter.....	H-5001	Hydraulic Oil Filter.....	HC-5508	ROBOT 190 (LOADERS) JCBAMFORD 444 (S/N: DIESELMAX-UP)	
Hydraulic Oil Filter.....	HC-8805	ROBOT 160 (LOADERS) PERKINS 404D-22T (S/N: TIER3-UP)		Hydraulic Oil Filter.....	HC-5508
Hydraulic Oil Filter.....	H-2719	Hydraulic Oil Filter.....	HC-5508	ROBOT 190 (LOADERS) PERKINS 1004.4	
JS450 (SHOVELS) ISUZU 6RB1TQB		ROBOT 165 (LOADERS) PEUGEOT XUD9 , 1993		Hydraulic Oil Filter.....	HC-5508
Hydraulic Oil Filter.....	H-2719	Hydraulic Oil Filter.....	HC-76080	ROBOT 190 (LOADERS) PERKINS 1004.4T	
Hydraulic Oil Filter.....	HC-8805	Hydraulic Oil Filter.....	HC-5508	Hydraulic Oil Filter.....	HC-5508
JS70 (SHOVELS) ISUZU 4JB1 PA12 (S/N: 695001-695500) , 1990-UP		Hydraulic Oil Filter.....	HC-5508	ROBOT 190 (LOADERS) PERKINS 1004.4T	
Hydraulic Oil Filter.....	H-2719	Hydraulic Oil Filter.....	HC-5508	Hydraulic Oil Filter.....	HC-5508



ENGINE APPLICATION

MODEL/APPLICATION	SAKURA NO	MODEL/APPLICATION	SAKURA NO	MODEL/APPLICATION	SAKURA NO
J. C. BAMFORD		JOHN DEERE		JOHN DEERE	
ROBOT 190HF (LOADERS) PERKINS 1104C-44		1040V (TRACTORS)		120 (CONSTRUCTION & MINING)	
Hydraulic Oil Filter.....	HC-5508	Hydraulic Oil Filter.....	H-7601	Hydraulic Oil Filter.....	H-2704
ROBOT 190HF (LOADERS) PERKINS 1104C-44/T		1085H4 (COMBINES)		Hydraulic Oil Filter.....	H-2704
Hydraulic Oil Filter.....	HC-5508	Hydraulic Oil Filter.....	HC-5502	125 (CONSTRUCTION & MINING) JOEERE DIESEL 120000	
TH530-120 ATMO (HANDLER TELESCOPIC)		110 (BACKHOE LOADERS) YANMAR 4TNE84		Hydraulic Oil Filter.....	HC-5511
Hydraulic Oil Filter.....	HC-7906	Hydraulic Oil Filter.....	HC-7602	125 (CONSTRUCTION & MINING) JOEERE GAS 120001	
TH530-95 ATMO (HANDLER TELESCOPIC)		110 (BACKHOE LOADERS) YANMAR 4TNV88		Hydraulic Oil Filter.....	HC-5511
Hydraulic Oil Filter.....	HC-7906	Hydraulic Oil Filter.....	HC-7602	125 (LOADERS) JOEERE DIESEL (S/N: T0-120000)	
JEEP		110 (CONSTRUCTION & MINING)		Hydraulic Oil Filter.....	HC-5511
CJ5-CJ8 (PASSENGER CARS) 2.5L , 2500, 1980-1983		Hydraulic Oil Filter.....	H-2704	125 (LOADERS) JOEERE GAS (S/N: 120001-UP)	
Hydraulic Oil Filter Transmission..	HC-45150	110TLB (EQUIPMENT)		Hydraulic Oil Filter.....	HC-5511
J. L. G INDUSTRIES		Hydraulic Oil Filter.....	HC-7602	1350 (AGRICULTURE)	
1250AJP (HANDLER TELESCOPIC) DEUTZ AG BF4M201F , 2004		1120 (AGRICULTURE)		Hydraulic Oil Filter.....	H-7601
Hydraulic Oil Filter.....	H-62100	Hydraulic Oil Filter.....	H-7601	Hydraulic Oil Filter.....	H-7601
33RTS (HANDLER TELESCOPIC)		Hydraulic Oil Filter.....	H-7601	1410D (EQUIPMENT)	
Hydraulic Oil Filter.....	HC-62010	1130 (AGRICULTURE)		Hydraulic Oil Filter.....	H-7602
3513 (HANDLER TELESCOPIC) PERKINS 1004-40 , 2004		Hydraulic Oil Filter.....	H-7601	1520 (AGRICULTURE)	
Hydraulic Oil Filter.....	HC-45030	Hydraulic Oil Filter.....	H-7601	Hydraulic Oil Filter.....	H-7601
35E (HANDLER TELESCOPIC)		1140 (AGRICULTURE)		Hydraulic Oil Filter.....	H-7601
Hydraulic Oil Filter.....	HC-1903	Hydraulic Oil Filter.....	H-7601	1530 (AGRICULTURE) JOEERE DIESEL	
Hydraulic Oil Filter.....	HC-1903	Hydraulic Oil Filter.....	H-7601	Hydraulic Oil Filter.....	H-7601
JOHN DEERE		1166 (COMBINES)		1530 (AGRICULTURE)	
1010D (CONSTRUCTION & MINING)		Hydraulic Oil Filter.....	HC-5502	Hydraulic Oil Filter.....	H-7601
Hydraulic Oil Filter.....	H-7602	1177 (COMBINES)		Hydraulic Oil Filter.....	H-7601
Hydraulic Oil Filter.....	H-7602	Hydraulic Oil Filter.....	HC-5502	1550 (AGRICULTURE)	
1020 (AGRICULTURE)		Hydraulic Oil Filter.....	HC-5502	Hydraulic Oil Filter.....	H-7601
Hydraulic Oil Filter.....	H-7601	1177 H4 (AGRICULTURE) JOEERE 6359 TZ 002 (6 CYL)		Hydraulic Oil Filter.....	H-7601
Hydraulic Oil Filter.....	H-7601	Hydraulic Oil Filter.....	H-7601	Hydraulic Oil Filter.....	H-7601
1020VU (TRACTORS)		Hydraulic Oil Filter.....	HC-5502	1600 (LAWN EQUIPMENT) YANMAR 4TNE88	
Hydraulic Oil Filter.....	H-7601	1177 SII H4 (AGRICULTURE) JOEERE 6359 TZ 002 (6 CYL)		Hydraulic Oil Filter.....	HC-76080
Hydraulic Oil Filter.....	H-7601	Hydraulic Oil Filter.....	H-7601	1600 TURBO (LAWN EQUIPMENT) YANMAR 4TNE88	
Hydraulic Oil Filter.....	H-7601	Hydraulic Oil Filter.....	H-7601	Hydraulic Oil Filter.....	HC-76080
1030 (AGRICULTURE)		1177H (COMBINES)		Hydraulic Oil Filter.....	H-2704
Hydraulic Oil Filter.....	H-7601	Hydraulic Oil Filter.....	HC-5502	160LC (EXCAVATORS)	
Hydraulic Oil Filter.....	H-7601	1188 (COMBINES) JOEERE 6466 TZ 001 (6 CYL)		Hydraulic Oil Filter.....	H-2704
Hydraulic Oil Filter.....	H-7601	Hydraulic Oil Filter.....	HC-5502	1630 (AGRICULTURE)	
Hydraulic Oil Filter.....	H-76070	Hydraulic Oil Filter.....	HC-5502	Hydraulic Oil Filter.....	H-7601
Hydraulic Oil Filter.....	H-76070	Hydraulic Oil Filter.....	HC-5502	Hydraulic Oil Filter.....	H-7601



ENGINE APPLICATION

MODEL/APPLICATION	SAKURA NO	MODEL/APPLICATION	SAKURA NO	MODEL/APPLICATION	SAKURA NO
JOHN DEERE		JOHN DEERE		JOHN DEERE	
1630VU (TRACTORS)		Hydraulic Oil Filter.....	H-7601	2140 (AGRICULTURE)	
Hydraulic Oil Filter.....	H-7601	2030 MANNHEIM-BU (AGRICULTURE) 2030 MANNHEIM-BUILT		Hydraulic Oil Filter.....	H-7601
1640 (AGRICULTURE)		Hydraulic Oil Filter.....	H-7601	Hydraulic Oil Filter.....	H-76070
Hydraulic Oil Filter.....	H-7601	2030 DUBUQUE-BUILT (TRACTORS)		Hydraulic Oil Filter.....	H-7601
Hydraulic Oil Filter.....	H-76070	Hydraulic Oil Filter.....	H-7601	2150 (AGRICULTURE)	
Hydraulic Oil Filter.....	H-7601	2030 MANNHEIM-BUILT (TRACTORS)		Hydraulic Oil Filter.....	H-7601
170 (LOADERS)		Hydraulic Oil Filter.....	H-7601	Hydraulic Oil Filter.....	H-7601
Hydraulic Oil Filter.....	H-79411	20300U (TRACTORS)		2155 (AGRICULTURE)	
170 (TRACTORS) WISCONSIN VG-4D		Hydraulic Oil Filter.....	H-7601	Hydraulic Oil Filter.....	H-7601
Hydraulic Oil Filter.....	H-51170	2040 DUBUQUE-BUIL (AGRICULTURE) 2040 DUBUQUE-BUILT		Hydraulic Oil Filter.....	H-7601
1750 (AGRICULTURE)		Hydraulic Oil Filter.....	H-7601	2240 MANNHEIM-BU (AGRICULTURE) 2240 MANNHEIM-BUILT	
Hydraulic Oil Filter.....	H-7601	2040 DUBUQUE-BUILT (TRACTORS)		Hydraulic Oil Filter.....	H-7601
Hydraulic Oil Filter.....	H-7601	Hydraulic Oil Filter.....	H-7601	2240 MANNHEIM-BUILT (TRACTORS)	
1830 (AGRICULTURE)		Hydraulic Oil Filter.....	H-7601	Hydraulic Oil Filter.....	H-76070
Hydraulic Oil Filter.....	H-7601	Hydraulic Oil Filter.....	H-76070	Hydraulic Oil Filter.....	H-7601
Hydraulic Oil Filter.....	H-7601	2040 MANNHEIM-BUILT (TRACTORS)		2250 (AGRICULTURE)	
1840 (AGRICULTURE)		Hydraulic Oil Filter.....	H-76070	Hydraulic Oil Filter.....	H-7601
Hydraulic Oil Filter.....	H-7601	Hydraulic Oil Filter.....	H-7601	Hydraulic Oil Filter.....	HC-7939
Hydraulic Oil Filter.....	H-7601	2040S SG2 (TRACTORS)		2255 (AGRICULTURE)	
1850 (AGRICULTURE)		Hydraulic Oil Filter.....	H-7601	Hydraulic Oil Filter.....	H-7601
Hydraulic Oil Filter.....	H-7601	210C (BACKHOE LOADERS)		2270 (AGRICULTURE) CHRYSLER HB225	
Hydraulic Oil Filter.....	H-7601	Hydraulic Oil Filter.....	HC-7606	Hydraulic Oil Filter.....	H-7601
190E (EXCAVATORS)		Hydraulic Oil Filter.....	HC-7603	2270 EUROPE (WINDROWERS)	
Hydraulic Oil Filter.....	H-2704	210E (LOADERS)		Hydraulic Oil Filter.....	HC-7939
1950 (AGRICULTURE) JDEERE 3179 TL 001 (3 CYL)		Hydraulic Oil Filter.....	HC-76110	2280 (WINDROWERS)	
Hydraulic Oil Filter.....	H-7601	Hydraulic Oil Filter.....	HC-7603	Hydraulic Oil Filter.....	HC-7939
Hydraulic Oil Filter.....	H-7601	210ELL (LOADERS)		2320 (WINDROWERS)	
2020 (AGRICULTURE) JDEERE DIESEL		Hydraulic Oil Filter.....	HC-76110	Hydraulic Oil Filter.....	HC-7939
Hydraulic Oil Filter.....	H-7601	210LE (LOADERS)		2350 (AGRICULTURE)	
2020 (AGRICULTURE) JDEERE GAS		Hydraulic Oil Filter.....	HC-76110	Hydraulic Oil Filter.....	H-7601
Hydraulic Oil Filter.....	H-7601	210LJ (LOADERS) JDEERE 4045HT POWERTECH E		Hydraulic Oil Filter.....	H-7601
2020 (AGRICULTURE)		Hydraulic Oil Filter.....	HC-76110	2355 (AGRICULTURE)	
Hydraulic Oil Filter.....	H-7601	Hydraulic Oil Filter.....	HC-76070	Hydraulic Oil Filter.....	H-7601
Hydraulic Oil Filter.....	H-7601	2120 (AGRICULTURE)		Hydraulic Oil Filter.....	H-7601
20200U (TRACTORS)		Hydraulic Oil Filter.....	H-7601	Hydraulic Oil Filter.....	H-7601
Hydraulic Oil Filter.....	H-7601	Hydraulic Oil Filter.....	H-7601	2355N (TRACTORS)	
2030 DUBUQUE-BUIL (AGRICULTURE) 2030 DUBUQUE-BUILT		2130 (AGRICULTURE)		Hydraulic Oil Filter.....	H-7601
		Hydraulic Oil Filter.....	H-7601		



ENGINE APPLICATION

MODEL/APPLICATION	SAKURA NO	MODEL/APPLICATION	SAKURA NO	MODEL/APPLICATION	SAKURA NO
JOHN DEERE		JOHN DEERE		JOHN DEERE	
2420 (WINDROWERS)		Hydraulic Oil Filter.....	H-7601	Hydraulic Oil Filter.....	H-7601
Hydraulic Oil Filter.....	HC-7939	2510 (AGRICULTURE)		27CZTS (AGRICULTURE)	
2440 (AGRICULTURE) JDEERE DIESEL		Hydraulic Oil Filter.....	H-7601	27CZTS	
Hydraulic Oil Filter.....	H-7601	Hydraulic Oil Filter.....	H-7601	Hydraulic Oil Filter.....	H-2712
Hydraulic Oil Filter.....	H-7601	2520 (AGRICULTURE) JDEERE 4276 DIESEL		27CZTS (EQUIPMENT)	
2450 (AGRICULTURE)		Hydraulic Oil Filter.....	H-7601	Hydraulic Oil Filter.....	H-2712
Hydraulic Oil Filter.....	H-7601	2520 (AGRICULTURE) JDEERE DIESEL		280 (LOADERS)	
24C (LOADERS) JDEERE DIESEL		Hydraulic Oil Filter.....	H-7601	Hydraulic Oil Filter.....	HC-5504
Hydraulic Oil Filter.....	H-79411	2520 (AGRICULTURE) JDEERE GAS		Hydraulic Oil Filter.....	HC-5508
24C (LOADERS) JDEERE GAS		Hydraulic Oil Filter.....	H-7601	2850 (AGRICULTURE)	
Hydraulic Oil Filter.....	H-79411	Hydraulic Oil Filter.....	H-7601	Hydraulic Oil Filter.....	H-7601
24D (LOADERS)		2550 (AGRICULTURE)		Hydraulic Oil Filter.....	H-7601
Hydraulic Oil Filter.....	H-79411	Hydraulic Oil Filter.....	H-7601	2940 (AGRICULTURE)	
24G (LOADERS)		2555 (AGRICULTURE)		Hydraulic Oil Filter.....	H-7601
Hydraulic Oil Filter.....	H-79411	Hydraulic Oil Filter.....	H-7601	Hydraulic Oil Filter.....	H-7601
2500A (AGRICULTURE) 2500A		2554 (LOGGERS)		2950 (AGRICULTURE)	
Hydraulic Oil Filter.....	HC-76100	Hydraulic Oil Filter.....	H-2706	Hydraulic Oil Filter.....	H-7601
2500A (LAWN EQUIPMENT) KAWASAKI GAS		2630 (AGRICULTURE)		Hydraulic Oil Filter.....	H-7601
Hydraulic Oil Filter.....	HC-76100	Hydraulic Oil Filter.....	H-7601	Hydraulic Oil Filter.....	H-7601
2500A (LAWN EQUIPMENT)		2640 (AGRICULTURE)		300 (CONSTRUCTION & MINING)	
Hydraulic Oil Filter.....	HC-76100	Hydraulic Oil Filter.....	H-7601	Hydraulic Oil Filter.....	H-7601
2500B (LAWN EQUIPMENT) KAWASAKI FD620D		Hydraulic Oil Filter.....	H-7601	Hydraulic Oil Filter.....	H-7601
Hydraulic Oil Filter.....	HC-76100	2650 (AGRICULTURE)		300B (BACKHOE LOADERS)	
2500B (LAWN EQUIPMENT) YANMAR 3TNV70		Hydraulic Oil Filter.....	H-7601	Hydraulic Oil Filter.....	H-7601
Hydraulic Oil Filter.....	HC-76100	Hydraulic Oil Filter.....	H-7601	301 (CONSTRUCTION & MINING)	
2500E (LAWN EQUIPMENT)		2653 (LAWN EQUIPMENT)		Hydraulic Oil Filter.....	H-7601
Hydraulic Oil Filter.....	HC-76100	Hydraulic Oil Filter.....	HC-76100	Hydraulic Oil Filter.....	H-7601
2500 (LAWN EQUIPMENT) KAWASAKI GAS		2653A (LAWN EQUIPMENT) YANMAR 3TNE68		3010 (AGRICULTURE) JDEERE DIESEL	
Hydraulic Oil Filter.....	HC-76100	Hydraulic Oil Filter.....	HC-76100	Hydraulic Oil Filter.....	H-7601
2500 (LAWN EQUIPMENT) YANMAR 3TNE68		2653B (LAWN EQUIPMENT)		3010 (AGRICULTURE) JDEERE GAS	
Hydraulic Oil Filter.....	HC-76100	Hydraulic Oil Filter.....	HC-76100	Hydraulic Oil Filter.....	HC-7932
2510 (AGRICULTURE) JDEERE DIESEL		2750 (AGRICULTURE)		Hydraulic Oil Filter.....	H-7601
Hydraulic Oil Filter.....	H-7601	Hydraulic Oil Filter.....	H-7601	Hydraulic Oil Filter.....	H-7601
2510 (AGRICULTURE) JDEERE GAS		2755 (AGRICULTURE)		301A (LOADERS)	
Hydraulic Oil Filter.....	H-7601	Hydraulic Oil Filter.....	H-7601	Hydraulic Oil Filter.....	H-7601



ENGINE APPLICATION

MODEL/APPLICATION	SAKURA NO	MODEL/APPLICATION	SAKURA NO	MODEL/APPLICATION	SAKURA NO
JOHN DEERE		JOHN DEERE		JOHN DEERE	
302 (CONSTRUCTION & MINING)		310 (BACKHOE LOADERS)		3150 (AGRICULTURE)	
Hydraulic Oil Filter.....	H-7601	Hydraulic Oil Filter.....	H-7601	Hydraulic Oil Filter.....	H-7601
Hydraulic Oil Filter.....	H-7601	Hydraulic Oil Filter.....	H-7601	Hydraulic Oil Filter.....	H-7601
3020 (AGRICULTURE) JDEERE DIESEL		310E (BACKHOE LOADERS)		3155 (AGRICULTURE)	
Hydraulic Oil Filter.....	HC-7932	Hydraulic Oil Filter.....	HC-76110	Hydraulic Oil Filter.....	H-7601
Hydraulic Oil Filter.....	H-7601	Hydraulic Oil Filter.....	HC-7603	Hydraulic Oil Filter.....	H-7601
3020 (AGRICULTURE) JDEERE GAS		310C (BACKHOE LOADERS)		315C (BACKHOE LOADERS)	
Hydraulic Oil Filter.....	HC-7932	Hydraulic Oil Filter.....	HC-7606	Hydraulic Oil Filter.....	HC-7603
Hydraulic Oil Filter.....	H-7601	Hydraulic Oil Filter.....	HC-7603	Hydraulic Oil Filter.....	HC-7606
3020 (AGRICULTURE) JDEERE LP GAS		310D (BACKHOE LOADERS)		315CH (BACKHOE LOADERS)	
Hydraulic Oil Filter.....	H-7601	Hydraulic Oil Filter.....	HC-7603	Hydraulic Oil Filter.....	HC-7606
3020 (AGRICULTURE)		310G (BACKHOE LOADERS)		315SG (BACKHOE LOADERS)	
Hydraulic Oil Filter.....	H-7601	Hydraulic Oil Filter.....	HC-76070	Hydraulic Oil Filter.....	HC-76110
Hydraulic Oil Filter.....	H-7601	Hydraulic Oil Filter.....	HC-76110		
302A (LOADERS)		310A (BACKHOE LOADERS)		315SG (LOADERS) S/N: T03155G946774-UP	
Hydraulic Oil Filter.....	H-7601	Hydraulic Oil Filter.....	H-7601	Hydraulic Oil Filter.....	HC-76110
3030 (AGRICULTURE)		310B (BACKHOE LOADERS)		315SJ (TRACTORS) JDEERE 4045T	
Hydraulic Oil Filter.....	H-7601	Hydraulic Oil Filter.....	H-7601	Hydraulic Oil Filter.....	HC-76110
Hydraulic Oil Filter.....	H-7601				
3032E (TRACTORS) YANMAR 3TNV88 , 1600		310SE (BACKHOE LOADERS)		3215B (LAWN EQUIPMENT) YANMAR	
Hydraulic Oil Filter Transmission..	HC-76150	Hydraulic Oil Filter.....	HC-76110	Hydraulic Oil Filter.....	HC-5504
		Hydraulic Oil Filter.....	HC-7603		
3038E (TRACTORS) YANMAR 3TNV84T , 1500		310J (BACKHOE LOADERS) JDEERE 4045T		3225B (LAWN EQUIPMENT) YANMAR	
Hydraulic Oil Filter Transmission..	HC-76150	Hydraulic Oil Filter.....	HC-76110	Hydraulic Oil Filter.....	HC-5504
3040 (AGRICULTURE)		310J (BACKHOE LOADERS) JDEERE 4045D		3225C (LAWN EQUIPMENT)	
Hydraulic Oil Filter.....	H-7601	Hydraulic Oil Filter.....	HC-76110	Hydraulic Oil Filter.....	HC-5507
Hydraulic Oil Filter.....	H-7601				
Hydraulic Oil Filter.....	H-76070	3120 (AGRICULTURE)		3235C (LAWN EQUIPMENT)	
		Hydraulic Oil Filter.....	H-7601	Hydraulic Oil Filter.....	HC-5507
		Hydraulic Oil Filter.....	H-7601		
3050 (AGRICULTURE) JDEERE 6359 DL 008 (6 CYL)		3130 (AGRICULTURE)		3245C (LAWN EQUIPMENT)	
Hydraulic Oil Filter.....	H-7601	Hydraulic Oil Filter.....	H-7601	Hydraulic Oil Filter.....	HC-5507
3050 (AGRICULTURE) JDEERE 6359 DL 009 (6 CYL)		3140 (AGRICULTURE)		3255 (AGRICULTURE)	
Hydraulic Oil Filter.....	H-7601	Hydraulic Oil Filter.....	H-7601	Hydraulic Oil Filter.....	H-7601
Hydraulic Oil Filter.....	H-7601	Hydraulic Oil Filter.....	H-7601	Hydraulic Oil Filter.....	H-7601
3050 (AGRICULTURE)		3140 (AGRICULTURE)		3325 (EQUIPMENT)	
Hydraulic Oil Filter.....	H-7601	Hydraulic Oil Filter.....	H-7601	Hydraulic Oil Filter.....	HC-7939
Hydraulic Oil Filter.....	H-7601	Hydraulic Oil Filter.....	H-76070	Hydraulic Oil Filter.....	HC-76100
		Hydraulic Oil Filter.....	H-7601		
3055 (AGRICULTURE)		3140DT (TRACTORS)		3340 (AGRICULTURE)	
Hydraulic Oil Filter.....	H-7601	Hydraulic Oil Filter.....	H-7601	Hydraulic Oil Filter.....	H-7601
Hydraulic Oil Filter.....	H-7601			Hydraulic Oil Filter.....	H-7601



ENGINE APPLICATION

MODEL/APPLICATION	SAKURA NO	MODEL/APPLICATION	SAKURA NO	MODEL/APPLICATION	SAKURA NO
JOHN DEERE		JOHN DEERE		JOHN DEERE	
3350 (AGRICULTURE) JDEERE 6359 DL 008 (6 CYL)		3830 (WINDROWERS)		4020 (AGRICULTURE) JDEERE DIESEL	
Hydraulic Oil Filter.....	H-7601	Hydraulic Oil Filter.....	HC-7939	Hydraulic Oil Filter.....	H-7601
3350 (AGRICULTURE) JDEERE 6359 DL 009 (6 CYL)		400 (CONSTRUCTION & MINING)		4020 (AGRICULTURE) JDEERE GAS	
Hydraulic Oil Filter.....	H-7601	Hydraulic Oil Filter.....	H-7601	Hydraulic Oil Filter.....	H-7601
3350 (AGRICULTURE)		Hydraulic Oil Filter.....	H-7601	4020 (AGRICULTURE) JDEERE LP GAS	
Hydraulic Oil Filter.....	H-7601	4000 (AGRICULTURE) JDEERE DIESEL		Hydraulic Oil Filter.....	H-7601
Hydraulic Oil Filter.....	H-7601	Hydraulic Oil Filter.....	H-7601	4020 (AGRICULTURE)	
3365 (EQUIPMENT)		4000 (AGRICULTURE) JDEERE GAS		Hydraulic Oil Filter.....	H-7601
Hydraulic Oil Filter.....	HC-7939	Hydraulic Oil Filter.....	H-7601	Hydraulic Oil Filter.....	H-7601
Hydraulic Oil Filter.....	HC-76100	4000 (AGRICULTURE) JDEERE LP GAS		4030 (AGRICULTURE) JDEERE 303 GAS	
3375 (LOADERS)		Hydraulic Oil Filter.....	H-7601	Hydraulic Oil Filter.....	H-7601
Hydraulic Oil Filter.....	HC-7925	4000 (AGRICULTURE)		4030 (AGRICULTURE) JDEERE 329 DIESEL	
3430 (WINDROWERS)		Hydraulic Oil Filter.....	H-7601	Hydraulic Oil Filter.....	H-7601
Hydraulic Oil Filter.....	HC-7939	Hydraulic Oil Filter.....	H-7601	4030 (AGRICULTURE)	
350C (CRAWLER LOADERS)		4005 (TRACTORS) YANMAR 4TNV84		Hydraulic Oil Filter.....	H-7601
Hydraulic Oil Filter.....	HC-7939	Hydraulic Oil Filter.....	HC-76120	Hydraulic Oil Filter.....	H-7601
Hydraulic Oil Filter.....	HC-5506	400G (CRAWLER DOZERS)		4040 (TRACTORS)	
355D (CRAWLER LOADERS)		Hydraulic Oil Filter.....	HC-7939	Hydraulic Oil Filter.....	H-76060
Hydraulic Oil Filter.....	HC-7939	Hydraulic Oil Filter.....	HC-7939	Hydraulic Oil Filter.....	H-76070
35CZTS (EQUIPMENT)		401 (CONSTRUCTION & MINING)		4040S (TRACTORS)	
Hydraulic Oil Filter.....	H-2712	Hydraulic Oil Filter.....	H-7601	Hydraulic Oil Filter.....	H-76060
360DC (SKIDDERS)		4010 (AGRICULTURE) JDEERE DIESEL , 1963		Hydraulic Oil Filter.....	H-76070
Hydraulic Oil Filter.....	HC-76070	Hydraulic Oil Filter.....	H-7601	4050 (TRACTORS)	
3640 (AGRICULTURE)		4010 (AGRICULTURE) JDEERE GAS		Hydraulic Oil Filter.....	H-76070
Hydraulic Oil Filter.....	H-7601	Hydraulic Oil Filter.....	HC-7932	Hydraulic Oil Filter.....	H-76060
Hydraulic Oil Filter.....	H-7601	Hydraulic Oil Filter.....	H-7601	4055 (TRACTORS) JDEERE 6 CYL 7.6L DIESEL	
3650 (AGRICULTURE) JDEERE 6359 TL 007 (6 CYL)		4010 (AGRICULTURE)		Hydraulic Oil Filter.....	H-76060
Hydraulic Oil Filter.....	H-7601	Hydraulic Oil Filter.....	H-7601	Hydraulic Oil Filter.....	H-76070
3650 (AGRICULTURE)		401B (LOADERS)		410 (BACKHOE LOADERS)	
Hydraulic Oil Filter.....	H-7601	Hydraulic Oil Filter.....	H-7601	Hydraulic Oil Filter.....	H-7601
Hydraulic Oil Filter.....	H-7601	401C (LOADERS)		Hydraulic Oil Filter.....	H-7601
375 (LOADERS)		Hydraulic Oil Filter.....	H-7601	410C (BACKHOE LOADERS)	
Hydraulic Oil Filter.....	HC-7925	Hydraulic Oil Filter.....	H-7601	Hydraulic Oil Filter.....	H-76060
380 (FORKLIFTS)		401D (LOADERS)		410D (BACKHOE LOADERS) JDEERE 276 CID DIESEL	
Hydraulic Oil Filter.....	H-7601	Hydraulic Oil Filter.....	H-7601	Hydraulic Oil Filter.....	HC-7603
				Hydraulic Oil Filter.....	HC-7939
				Hydraulic Oil Filter.....	HC-7604



ENGINE APPLICATION

MODEL/APPLICATION	SAKURA NO	MODEL/APPLICATION	SAKURA NO	MODEL/APPLICATION	SAKURA NO
JOHN DEERE		JOHN DEERE		JOHN DEERE	
410B (BACKHOE LOADERS)		Hydraulic Oil Filter.....	H-76070	4440 (TRACTORS) JDEERE DIESEL	
Hydraulic Oil Filter.....	H-76060	Hydraulic Oil Filter.....	H-76060	Hydraulic Oil Filter.....	H-76060
410E (BACKHOE LOADERS)		4255 (TRACTORS) JDEERE 6 CYL 7.6L DIESEL		Hydraulic Oil Filter.....	H-76070
Hydraulic Oil Filter.....	HC-7603	Hydraulic Oil Filter.....	H-76070	Hydraulic Oil Filter.....	H-76070
Hydraulic Oil Filter.....	HC-76110	Hydraulic Oil Filter.....	H-76060	444C (LOADERS)	
410G (BACKHOE LOADERS)		4300 (TRACTORS)		Hydraulic Oil Filter.....	H-7601
Hydraulic Oil Filter.....	HC-7603	Hydraulic Oil Filter.....	HC-76100	444CH (LOADERS)	
Hydraulic Oil Filter.....	HC-76070	4310 (TRACTORS)		Hydraulic Oil Filter.....	H-7601
410J (BACKHOE LOADERS) JDEERE 4045T		Hydraulic Oil Filter.....	HC-76100	444D (LOADERS)	
Hydraulic Oil Filter.....	HC-76110	4320 (AGRICULTURE) JDEERE DIESEL		Hydraulic Oil Filter.....	HC-7606
410J (LOADERS) JDEERE 4045HT POWERTECH E		Hydraulic Oil Filter.....	H-7601	444J (LOADERS)	
Hydraulic Oil Filter.....	HC-76110	4320 (TRACTORS) JDEERE 6.404T		Hydraulic Oil Filter Transmission...	HC-76130
Hydraulic Oil Filter.....	HC-76070	Hydraulic Oil Filter.....	H-7601	4450 (TRACTORS) JDEERE DIESEL	
415B (BACKHOE LOADERS)		4340S (TRACTORS) JDEERE DIESEL		Hydraulic Oil Filter.....	H-76070
Hydraulic Oil Filter.....	H-76060	Hydraulic Oil Filter.....	H-76070	Hydraulic Oil Filter.....	H-76060
4200 (TRACTORS)		Hydraulic Oil Filter.....	H-76060	4455 (TRACTORS) JDEERE 6 CYL 7.6L DIESEL	
Hydraulic Oil Filter.....	HC-76100	4350 (TRACTORS)		Hydraulic Oil Filter.....	H-76070
4210 (TRACTORS)		Hydraulic Oil Filter.....	H-76060	Hydraulic Oil Filter.....	H-76060
Hydraulic Oil Filter.....	HC-76100	440 (CONSTRUCTION & MINING)		4500 (TRACTORS)	
4230 (AGRICULTURE) JDEERE 362 GAS		Hydraulic Oil Filter.....	H-7601	Hydraulic Oil Filter.....	HC-76100
Hydraulic Oil Filter.....	H-7601	Hydraulic Oil Filter.....	H-7601	450D (CRAWLER DOZERS)	
4230 (AGRICULTURE) JDEERE 404 DIESEL		4400 (TRACTORS)		Hydraulic Oil Filter.....	HC-7939
Hydraulic Oil Filter.....	H-7601	Hydraulic Oil Filter.....	HC-76100	450C (CRAWLER LOADERS)	
4230 (TRACTORS) JDEERE 362 GAS		440C (SKIDDERS)		Hydraulic Oil Filter.....	HC-7939
Hydraulic Oil Filter.....	H-76070	Hydraulic Oil Filter.....	H-7601	450CLC (EXCAVATORS)	
Hydraulic Oil Filter.....	H-7601	4410 (TRACTORS)		Hydraulic Oil Filter.....	H-2709
4230 (TRACTORS) JDEERE 404 DIESEL		Hydraulic Oil Filter.....	HC-76100	450E (CRAWLER DOZERS)	
Hydraulic Oil Filter.....	H-76070	4430 (AGRICULTURE)		Hydraulic Oil Filter.....	HC-7939
Hydraulic Oil Filter.....	H-7601	Hydraulic Oil Filter.....	H-7601	450G (CRAWLER DOZERS)	
4240 (TRACTORS) JDEERE DIESEL		4430 (TRACTORS) JDEERE 404 DIESEL		Hydraulic Oil Filter.....	HC-7939
Hydraulic Oil Filter.....	H-76070	Hydraulic Oil Filter.....	H-7601	450H (CRAWLER DOZERS)	
Hydraulic Oil Filter.....	H-76060	Hydraulic Oil Filter.....	H-76070	Hydraulic Oil Filter.....	HC-5504
4240S (AGRICULTURE) JDEERE DIESEL		444 (CONSTRUCTION & MINING)		450LC (EXCAVATORS)	
Hydraulic Oil Filter.....	H-7601	Hydraulic Oil Filter.....	H-7601	Hydraulic Oil Filter.....	H-2709
Hydraulic Oil Filter.....	H-76060	Hydraulic Oil Filter.....	H-7601	450HLGP (EQUIPMENT)	
Hydraulic Oil Filter.....	H-7601	444H (LOADERS) JDEERE 4045T		Hydraulic Oil Filter.....	HC-5504
4250 (TRACTORS)		Hydraulic Oil Filter.....	HC-7603		



ENGINE APPLICATION

MODEL/APPLICATION	SAKURA NO	MODEL/APPLICATION	SAKURA NO	MODEL/APPLICATION	SAKURA NO
JOHN DEERE		JOHN DEERE		JOHN DEERE	
450HLT (EQUIPMENT)		4650 (TRACTORS)		488E (FORKLIFTS)	
Hydraulic Oil Filter.....	HC-5504	Hydraulic Oil Filter.....	H-76060	Hydraulic Oil Filter.....	HC-76110
450J (CRAWLER DOZERS) JDEERE 4045T		Hydraulic Oil Filter.....	H-76070	Hydraulic Oil Filter.....	HC-5504
Hydraulic Oil Filter.....	HC-5504	4700 (TRACTORS)		490D (EXCAVATORS)	
4510 (TRACTORS)		Hydraulic Oil Filter.....	HC-76100	Hydraulic Oil Filter.....	H-2704
Hydraulic Oil Filter.....	HC-76100	4755 (TRACTORS)		490E (EXCAVATORS)	
4520 (AGRICULTURE) JDEERE 404 DIESEL		Hydraulic Oil Filter.....	H-76060	Hydraulic Oil Filter.....	H-2704
Hydraulic Oil Filter.....	H-7601	Hydraulic Oil Filter.....	H-76070	493D (FELLER BUNCHERS)	
Hydraulic Oil Filter.....	H-7601	4760 (TRACTORS)		Hydraulic Oil Filter.....	H-2704
4555 (TRACTORS) JDEERE 6 CYL 7.6L DIESEL		Hydraulic Oil Filter.....	H-76060	4955 (TRACTORS)	
Hydraulic Oil Filter.....	H-76060	Hydraulic Oil Filter.....	H-76070	Hydraulic Oil Filter.....	H-76060
Hydraulic Oil Filter.....	H-76070	480 (FORKLIFTS)		Hydraulic Oil Filter.....	H-76070
455D (CRAWLER LOADERS)		Hydraulic Oil Filter.....	H-7601	495D (EXCAVATORS)	
Hydraulic Oil Filter.....	HC-7939	480B (FORKLIFTS)		Hydraulic Oil Filter.....	H-2704
455E (CRAWLER LOADERS)		Hydraulic Oil Filter.....	H-7601	500 (CONSTRUCTION & MINING)	
Hydraulic Oil Filter.....	HC-7939	480C (FORKLIFTS)		Hydraulic Oil Filter.....	H-7601
455G (CRAWLER LOADERS)		Hydraulic Oil Filter.....	H-7601	Hydraulic Oil Filter.....	H-7601
Hydraulic Oil Filter.....	HC-7939	480A (FORKLIFTS)		500C (BACKHOE LOADERS)	
4600 (TRACTORS)		Hydraulic Oil Filter.....	H-7601	Hydraulic Oil Filter.....	H-7601
Hydraulic Oil Filter.....	HC-76100	482C (FORKLIFTS)		500B (BACKHOE LOADERS)	
460DC (SKIDDERS) JDEERE 6068H		Hydraulic Oil Filter.....	HC-7606	Hydraulic Oil Filter.....	H-7601
Hydraulic Oil Filter.....	HC-76090	484 (AGRICULTURE) JDEERE 6-329 DIESEL		500A (BACKHOE LOADERS)	
Hydraulic Oil Filter.....	HC-76070	Hydraulic Oil Filter.....	HC-7932	Hydraulic Oil Filter.....	H-7601
460DC (SKIDDERS) JDEERE 6068T		484 (AGRICULTURE) JDEERE 6-359 DIESEL		5010 (AGRICULTURE) JDEERE DIESEL	
Hydraulic Oil Filter.....	HC-76090	Hydraulic Oil Filter.....	HC-7932	Hydraulic Oil Filter.....	H-7601
4610 (TRACTORS)		4840 (TRACTORS) JDEERE DIESEL		Hydraulic Oil Filter.....	H-7601
Hydraulic Oil Filter.....	HC-76100	Hydraulic Oil Filter.....	H-76060	5020 (AGRICULTURE) JDEERE DIESEL	
4620 (AGRICULTURE) JDEERE DIESEL		4850 (TRACTORS)		Hydraulic Oil Filter.....	H-7601
Hydraulic Oil Filter.....	H-7601	Hydraulic Oil Filter.....	H-76060	Hydraulic Oil Filter.....	H-7601
Hydraulic Oil Filter.....	H-7601	Hydraulic Oil Filter.....	H-76070	5045D (TRACTORS) JDEERE 3029 POWERTECH	
4630 (AGRICULTURE) JDEERE 404 DIESEL		485E (FORKLIFTS)		Hydraulic Oil Filter.....	HC-7602
Hydraulic Oil Filter.....	H-7601	Hydraulic Oil Filter.....	HC-76110	5083E (TRACTORS) JDEERE 4.5L POWERTECH TURBO	
Hydraulic Oil Filter.....	H-76070	Hydraulic Oil Filter.....	HC-5504	Hydraulic Oil Filter.....	HC-7602
Hydraulic Oil Filter.....	H-7601	486E (FORKLIFTS)		50CZTS (EQUIPMENT)	
4640 (TRACTORS) JDEERE DIESEL		Hydraulic Oil Filter.....	HC-5504	Hydraulic Oil Filter.....	H-2712
Hydraulic Oil Filter.....	H-76070	Hydraulic Oil Filter.....	HC-76110		
Hydraulic Oil Filter.....	H-76060				



ENGINE APPLICATION

MODEL/APPLICATION	SAKURA NO	MODEL/APPLICATION	SAKURA NO	MODEL/APPLICATION	SAKURA NO
JOHN DEERE		JOHN DEERE		JOHN DEERE	
510 (BACKHOE LOADERS)		Hydraulic Oil Filter.....	H-7601	544E (LOADERS)	
Hydraulic Oil Filter.....	H-7601	5400 (TRACTORS)		Hydraulic Oil Filter Transmission...	HC-2701
Hydraulic Oil Filter.....	H-7601	Hydraulic Oil Filter.....	HC-7602	544G (LOADERS)	
510B (BACKHOE LOADERS)		540B (SKIDDERS)		Hydraulic Oil Filter Transmission...	HC-2701
Hydraulic Oil Filter.....	H-76060	Hydraulic Oil Filter.....	H-76070	544J (LOADERS)	
510C (BACKHOE LOADERS)		Hydraulic Oil Filter.....	H-7601	Hydraulic Oil Filter Transmission...	HC-76130
Hydraulic Oil Filter.....	H-76060	5403 (TRACTORS)		5480 (AGRICULTURE)	
5103 (TRACTORS)		JDEERE 3029T		Hydraulic Oil Filter.....	HC-7932
Hydraulic Oil Filter.....	HC-7602	Hydraulic Oil Filter.....	HC-7602	548G (LOADERS)	
5105 (TRACTORS)		540GII (SKIDDERS)		JDEERE 6059T	
Hydraulic Oil Filter.....	HC-7602	Hydraulic Oil Filter.....	HC-76090	Hydraulic Oil Filter.....	HC-7603
510D (BACKHOE LOADERS)		540GIII (LOADERS)		550 (CONSTRUCTION & MINING)	
JDEERE TURBO DIESEL		JDEERE 6068		Hydraulic Oil Filter.....	H-7601
Hydraulic Oil Filter.....	HC-7939	Hydraulic Oil Filter.....	HC-76070	Hydraulic Oil Filter.....	H-7601
Hydraulic Oil Filter.....	HC-7604	540GIII (LOADERS)		Hydraulic Oil Filter.....	HC-7939
Hydraulic Oil Filter.....	HC-7603	JDEERE 6068H		5500 (TRACTORS)	
515B (BACKHOE LOADERS)		Hydraulic Oil Filter.....	HC-76070	Hydraulic Oil Filter.....	HC-7602
Hydraulic Oil Filter.....	H-76060	540GIII (SKIDDERS)		550LC (EXCAVATORS)	
5200 (TRACTORS)		S/N: 576603-UP		CUMMINS N14	
Hydraulic Oil Filter.....	HC-7602	Hydraulic Oil Filter.....	HC-7602	Hydraulic Oil Filter.....	H-2709
5205 (TRACTORS)		5410 (TRACTORS)		550G (CRAWLER DOZERS)	
Hydraulic Oil Filter.....	HC-7602	Hydraulic Oil Filter.....	HC-7602	Hydraulic Oil Filter.....	HC-7939
5210 (TRACTORS)		5420 (TRACTORS)		550H (EQUIPMENT)	
Hydraulic Oil Filter.....	HC-7602	Hydraulic Oil Filter.....	HC-7602	Hydraulic Oil Filter.....	HC-5504
5220 (TRACTORS)		5425 (TRACTORS)		550A (CRAWLER DOZERS)	
Hydraulic Oil Filter.....	HC-7602	JDEERE 4045T POWERTECH		Hydraulic Oil Filter.....	HC-7939
5303 (TRACTORS)		Hydraulic Oil Filter.....	HC-7602	Hydraulic Oil Filter.....	H-7601
Hydraulic Oil Filter.....	HC-7602	5420N (LOADERS)		550B (CRAWLER DOZERS)	
5310 (TRACTORS)		Hydraulic Oil Filter.....	HC-7602	Hydraulic Oil Filter.....	H-7601
Hydraulic Oil Filter.....	HC-7602	544 (CONSTRUCTION & MINING)		Hydraulic Oil Filter.....	HC-7939
5320 (TRACTORS)		Hydraulic Oil Filter.....	H-7601	550HLGP (EQUIPMENT)	
Hydraulic Oil Filter.....	HC-7602	544H (LOADERS)		Hydraulic Oil Filter.....	HC-5504
5320N (LOADERS)		JDEERE		550J (CRAWLER DOZERS)	
Hydraulic Oil Filter.....	HC-7602	Hydraulic Oil Filter.....	HC-7603	JDEERE 4045T	
540 (CONSTRUCTION & MINING)		544B (LOADERS)		Hydraulic Oil Filter.....	HC-5504
Hydraulic Oil Filter.....	H-7601	Hydraulic Oil Filter.....	H-7601	Hydraulic Oil Filter.....	HC-5504
5400 (TRACTORS)		544C (LOADERS)		5510 (TRACTORS)	
Hydraulic Oil Filter.....	H-7601	Hydraulic Oil Filter.....	H-7601	Hydraulic Oil Filter.....	HC-7602
5400 (TRACTORS)		544D (LOADERS)		5500 (CRAWLER DOZERS)	
Hydraulic Oil Filter.....	H-7601	Hydraulic Oil Filter.....	HC-7606	Hydraulic Oil Filter.....	HC-7602
5400 (TRACTORS)		544E (LOADERS)		5500 (CRAWLER DOZERS)	
Hydraulic Oil Filter.....	H-7601	Hydraulic Oil Filter.....	HC-7606	Hydraulic Oil Filter.....	HC-7602
5400 (TRACTORS)		544F (LOADERS)		5500 (CRAWLER DOZERS)	
Hydraulic Oil Filter.....	H-7601	Hydraulic Oil Filter.....	HC-7606	Hydraulic Oil Filter.....	HC-7602
5400 (TRACTORS)		544G (LOADERS)		5500 (CRAWLER DOZERS)	
Hydraulic Oil Filter.....	H-7601	Hydraulic Oil Filter.....	HC-7606	Hydraulic Oil Filter.....	HC-7602
5400 (TRACTORS)		544H (LOADERS)		5500 (CRAWLER DOZERS)	
Hydraulic Oil Filter.....	H-7601	Hydraulic Oil Filter.....	HC-7606	Hydraulic Oil Filter.....	HC-7602
5400 (TRACTORS)		544I (LOADERS)		5500 (CRAWLER DOZERS)	
Hydraulic Oil Filter.....	H-7601	Hydraulic Oil Filter.....	HC-7606	Hydraulic Oil Filter.....	HC-7602
5400 (TRACTORS)		544J (LOADERS)		5500 (CRAWLER DOZERS)	
Hydraulic Oil Filter.....	H-7601	Hydraulic Oil Filter.....	HC-7606	Hydraulic Oil Filter.....	HC-7602
5400 (TRACTORS)		544K (LOADERS)		5500 (CRAWLER DOZERS)	
Hydraulic Oil Filter.....	H-7601	Hydraulic Oil Filter.....	HC-7606	Hydraulic Oil Filter.....	HC-7602
5400 (TRACTORS)		544L (LOADERS)		5500 (CRAWLER DOZERS)	
Hydraulic Oil Filter.....	H-7601	Hydraulic Oil Filter.....	HC-7606	Hydraulic Oil Filter.....	HC-7602
5400 (TRACTORS)		544M (LOADERS)		5500 (CRAWLER DOZERS)	
Hydraulic Oil Filter.....	H-7601	Hydraulic Oil Filter.....	HC-7606	Hydraulic Oil Filter.....	HC-7602
5400 (TRACTORS)		544N (LOADERS)		5500 (CRAWLER DOZERS)	
Hydraulic Oil Filter.....	H-7601	Hydraulic Oil Filter.....	HC-7606	Hydraulic Oil Filter.....	HC-7602
5400 (TRACTORS)		544O (LOADERS)		5500 (CRAWLER DOZERS)	
Hydraulic Oil Filter.....	H-7601	Hydraulic Oil Filter.....	HC-7606	Hydraulic Oil Filter.....	HC-7602
5400 (TRACTORS)		544P (LOADERS)		5500 (CRAWLER DOZERS)	
Hydraulic Oil Filter.....	H-7601	Hydraulic Oil Filter.....	HC-7606	Hydraulic Oil Filter.....	HC-7602
5400 (TRACTORS)		544Q (LOADERS)		5500 (CRAWLER DOZERS)	
Hydraulic Oil Filter.....	H-7601	Hydraulic Oil Filter.....	HC-7606	Hydraulic Oil Filter.....	HC-7602
5400 (TRACTORS)		544R (LOADERS)		5500 (CRAWLER DOZERS)	
Hydraulic Oil Filter.....	H-7601	Hydraulic Oil Filter.....	HC-7606	Hydraulic Oil Filter.....	HC-7602
5400 (TRACTORS)		544S (LOADERS)		5500 (CRAWLER DOZERS)	
Hydraulic Oil Filter.....	H-7601	Hydraulic Oil Filter.....	HC-7606	Hydraulic Oil Filter.....	HC-7602
5400 (TRACTORS)		544T (LOADERS)		5500 (CRAWLER DOZERS)	
Hydraulic Oil Filter.....	H-7601	Hydraulic Oil Filter.....	HC-7606	Hydraulic Oil Filter.....	HC-7602
5400 (TRACTORS)		544U (LOADERS)		5500 (CRAWLER DOZERS)	
Hydraulic Oil Filter.....	H-7601	Hydraulic Oil Filter.....	HC-7606	Hydraulic Oil Filter.....	HC-7602
5400 (TRACTORS)		544V (LOADERS)		5500 (CRAWLER DOZERS)	
Hydraulic Oil Filter.....	H-7601	Hydraulic Oil Filter.....	HC-7606	Hydraulic Oil Filter.....	HC-7602
5400 (TRACTORS)		544W (LOADERS)		5500 (CRAWLER DOZERS)	
Hydraulic Oil Filter.....	H-7601	Hydraulic Oil Filter.....	HC-7606	Hydraulic Oil Filter.....	HC-7602
5400 (TRACTORS)		544X (LOADERS)		5500 (CRAWLER DOZERS)	
Hydraulic Oil Filter.....	H-7601	Hydraulic Oil Filter.....	HC-7606	Hydraulic Oil Filter.....	HC-7602
5400 (TRACTORS)		544Y (LOADERS)		5500 (CRAWLER DOZERS)	
Hydraulic Oil Filter.....	H-7601	Hydraulic Oil Filter.....	HC-7606	Hydraulic Oil Filter.....	HC-7602
5400 (TRACTORS)		544Z (LOADERS)		5500 (CRAWLER DOZERS)	
Hydraulic Oil Filter.....	H-7601	Hydraulic Oil Filter.....	HC-7606	Hydraulic Oil Filter.....	HC-7602



ENGINE APPLICATION

MODEL/APPLICATION	SAKURA NO	MODEL/APPLICATION	SAKURA NO	MODEL/APPLICATION	SAKURA NO
JOHN DEERE		JOHN DEERE		JOHN DEERE	
5520 (TRACTORS)		5720 (WINDROWERS) S/N: TO-242196		605C (LOADERS)	
Hydraulic Oil Filter.....	HC-7602	Hydraulic Oil Filter.....	HC-7939	Hydraulic Oil Filter.....	HC-5504
555 (CONSTRUCTION & MINING)		5725 (TRACTORS) JDEERE 4045T POWERTECH		6100 (TRACTORS) JDEERE 4 CYL	
Hydraulic Oil Filter.....	H-7601	Hydraulic Oil Filter.....	HC-7602	Hydraulic Oil Filter.....	HC-5508
Hydraulic Oil Filter.....	H-7601			Hydraulic Oil Filter.....	HC-76080
Hydraulic Oil Filter.....	HC-7939	5730 (HARVESTERS)		6110 (TRACTORS)	
555A (CRAWLER LOADERS)		Hydraulic Oil Filter.....	HC-7939	Hydraulic Oil Filter.....	HC-5508
Hydraulic Oil Filter.....	H-7601	575 (LOADERS)		Hydraulic Oil Filter.....	HC-76080
Hydraulic Oil Filter.....	HC-7939	Hydraulic Oil Filter.....	HC-7925	6120 (AGRICULTURE) 4045T , 2001	
555B (LOADERS)		Hydraulic Oil Filter.....	HC-5511	Hydraulic Oil Filter.....	HC-76080
Hydraulic Oil Filter.....	H-7601	5820 (HARVESTERS)		6120 (TRACTORS)	
Hydraulic Oil Filter.....	HC-7939	Hydraulic Oil Filter.....	HC-7939	Hydraulic Oil Filter.....	HC-5504
555G (LOADERS)		5830 (HARVESTERS)		6200 (TRACTORS)	
Hydraulic Oil Filter.....	HC-7939	Hydraulic Oil Filter.....	HC-7939	Hydraulic Oil Filter.....	HC-76080
560D (SKIDDERS)		590D (EXCAVATORS)		Hydraulic Oil Filter.....	HC-5508
Hydraulic Oil Filter.....	HC-76070	Hydraulic Oil Filter.....	H-2704	6200L (TRACTORS) JDEERE 4045T	
5603 (TRACTORS) JDEERE 4045TL		595 (CONSTRUCTION & MINING)		Hydraulic Oil Filter.....	HC-5508
Hydraulic Oil Filter.....	HC-7602	Hydraulic Oil Filter.....	H-2704	Hydraulic Oil Filter.....	HC-76080
5605 (TRACTORS) JDEERE 4045D		600 (CONSTRUCTION & MINING)		6210 (TRACTORS)	
Hydraulic Oil Filter.....	HC-7602	Hydraulic Oil Filter.....	H-7601	Hydraulic Oil Filter.....	HC-76080
5615 (TRACTORS) JDEERE 4045T		Hydraulic Oil Filter.....	H-7601	Hydraulic Oil Filter.....	HC-5508
Hydraulic Oil Filter.....	HC-7602	6000 (AGRICULTURE)		6220 (AGRICULTURE) 4045T , 2001	
570 (CONSTRUCTION & MINING)		Hydraulic Oil Filter.....	HC-7932	Hydraulic Oil Filter.....	HC-76080
Hydraulic Oil Filter.....	H-7601	Hydraulic Oil Filter.....	HC-76080	6220 (TRACTORS)	
Hydraulic Oil Filter.....	H-7601	600CLC (EXCAVATORS)		Hydraulic Oil Filter.....	HC-5504
Hydraulic Oil Filter.....	H-76070	Hydraulic Oil Filter.....	H-2709	6230 (AGRICULTURE) 4 CYL. , 2006	
Hydraulic Oil Filter.....	HC-5511	6000 SERIES (TRACTORS)		Hydraulic Oil Filter.....	HC-76080
Hydraulic Oil Filter.....	HC-7925	Hydraulic Oil Filter.....	HC-5504	624H (LOADERS) JDEERE 6068 POWERTECH	
570B (GRADERS)		6010 (TRACTORS) S/N: 75HP-UP		Hydraulic Oil Filter Transmission...	HC-76130
Hydraulic Oil Filter.....	H-76070	Hydraulic Oil Filter.....	HC-5508	624HLL (LOADERS) JDEERE	
Hydraulic Oil Filter.....	H-7601	Hydraulic Oil Filter.....	HC-5504	Hydraulic Oil Filter.....	HC-7603
5715 (TRACTORS) JDEERE 4045T POWERTECH		6020 (TRACTORS)		624E (LOADERS)	
Hydraulic Oil Filter.....	HC-7602	Hydraulic Oil Filter.....	HC-5504	Hydraulic Oil Filter Transmission...	HC-2701
5720 (HARVESTERS)		6030 (AGRICULTURE)		Hydraulic Oil Filter.....	HC-7604
Hydraulic Oil Filter.....	HC-7939	Hydraulic Oil Filter.....	H-7601	624G (LOADERS)	
5720 (WINDROWERS) S/N: 242197-UP		Hydraulic Oil Filter.....	H-7601	Hydraulic Oil Filter Transmission...	HC-2701
Hydraulic Oil Filter.....	HC-7939			Hydraulic Oil Filter.....	HC-7604



ENGINE APPLICATION

MODEL/APPLICATION	SAKURA NO	MODEL/APPLICATION	SAKURA NO	MODEL/APPLICATION	SAKURA NO
JOHN DEERE		JOHN DEERE		JOHN DEERE	
6300U (TRACTORS)		643 (FELLER BUNCHERS)		646C (COMPACTORS)	
Hydraulic Oil Filter.....	H-7601	Hydraulic Oil Filter.....	HC-7604	Hydraulic Oil Filter.....	H-7601
6310 (TRACTORS)		Hydraulic Oil Filter.....	HC-7606	648GII (SKIDDERS)	
Hydraulic Oil Filter.....	HC-76080	643D (FELLER BUNCHERS)		Hydraulic Oil Filter.....	HC-76090
Hydraulic Oil Filter.....	HC-5508	Hydraulic Oil Filter.....	HC-7606	648H (LOADERS) JDEERE 6081	
6320 (TRACTORS) JDEERE 4045 POWERTECH		Hydraulic Oil Filter.....	HC-7604	Hydraulic Oil Filter.....	HC-76090
Hydraulic Oil Filter.....	HC-5504	643G (FELLER BUNCHERS)		6500 (TRACTORS)	
6330 (AGRICULTURE) 4 CYL. , 2006		Hydraulic Oil Filter.....	HC-7604	Hydraulic Oil Filter.....	HC-76080
Hydraulic Oil Filter.....	HC-76080	644 (CONSTRUCTION & MINING)		Hydraulic Oil Filter.....	HC-5508
640 (CONSTRUCTION & MINING)		Hydraulic Oil Filter.....	H-7601	650G (DOZERS)	
Hydraulic Oil Filter.....	H-7601	Hydraulic Oil Filter.....	H-7601	Hydraulic Oil Filter.....	HC-7939
Hydraulic Oil Filter.....	H-76070	644J (LOADERS)		650H (CRAWLER DOZERS)	
Hydraulic Oil Filter.....	H-7601	Hydraulic Oil Filter Transmission..	HC-76130	Hydraulic Oil Filter.....	HC-5504
6405 (AGRICULTURE) John Deere 4045T , 1998-2002		644B (LOADERS)		6506 (TRACTORS)	
Hydraulic Oil Filter.....	HC-76080	Hydraulic Oil Filter.....	H-7601	Hydraulic Oil Filter.....	HC-76080
6405 (TRACTORS)		644C (LOADERS)		Hydraulic Oil Filter.....	HC-5508
Hydraulic Oil Filter.....	HC-76080	Hydraulic Oil Filter.....	H-7601	650J SERIES (CRAWLER DOZERS) JDEERE 4045H	
640GII (SKIDDERS)		644D (LOADERS)		Hydraulic Oil Filter.....	HC-5504
Hydraulic Oil Filter.....	HC-76090	Hydraulic Oil Filter.....	HC-7606	6510 (TRACTORS) JDEERE 4045 POWERTECH	
6400L (TRACTORS) JDEERE 4045T		644E (COMPACTORS)		Hydraulic Oil Filter.....	HC-76080
Hydraulic Oil Filter.....	HC-76080	Hydraulic Oil Filter Transmission...	HC-2701	Hydraulic Oil Filter.....	HC-5508
Hydraulic Oil Filter.....	HC-5508	Hydraulic Oil Filter.....	H-7601	6510 (TRACTORS)	
640GIII (SKIDDERS) S/N: 576603-UP		Hydraulic Oil Filter Transmission...	HC-2701	Hydraulic Oil Filter.....	HC-76080
Hydraulic Oil Filter.....	HC-76070	Hydraulic Oil Filter.....	HC-7604	Hydraulic Oil Filter.....	HC-5508
640H (LOADERS) JDEERE 6081		644ER (LOADERS)		6520 (TRACTORS) JDEERE (S/N: 110 HP-UP) , 2001-UP	
Hydraulic Oil Filter.....	HC-76090	Hydraulic Oil Filter.....	HC-7604	Hydraulic Oil Filter.....	HC-5504
6410 (TRACTORS)		Hydraulic Oil Filter Transmission...	HC-2701	6530 (AGRICULTURE) 6 CYL. , 2006	
Hydraulic Oil Filter.....	HC-5508	Hydraulic Oil Filter.....	HC-7604	Hydraulic Oil Filter.....	HC-76080
Hydraulic Oil Filter.....	HC-76080	644EZ (LOADERS)		6531D (POWER UNITS) JDEERE DIESEL	
6420 (TRACTORS) JDEERE 4045 POWERTECH , 2001-UP		Hydraulic Oil Filter Transmission...	HC-2701	Hydraulic Oil Filter.....	H-7601
Hydraulic Oil Filter.....	HC-5504	Hydraulic Oil Filter.....	HC-7604	653E (FELLER BUNCHERS)	
6420S (TRACTORS) JDEERE 4045 POWERTECH		644G (LOADERS)		Hydraulic Oil Filter.....	HC-7604
Hydraulic Oil Filter.....	HC-5504	Hydraulic Oil Filter Transmission...	HC-2701	655 (TRACTORS)	
6430 (AGRICULTURE) 4 CYL. , 2006		Hydraulic Oil Filter.....	HC-7604	Hydraulic Oil Filter.....	HC-76100
Hydraulic Oil Filter.....	HC-76080	646 (COMPACTORS)		655C (EQUIPMENT)	
		Hydraulic Oil Filter.....	H-7601		
		Hydraulic Oil Filter.....	H-7601		
		646B (COMPACTORS)			
		Hydraulic Oil Filter.....	H-7601		
		Hydraulic Oil Filter.....	H-7601		



ENGINE APPLICATION

MODEL/APPLICATION	SAKURA NO	MODEL/APPLICATION	SAKURA NO	MODEL/APPLICATION	SAKURA NO
JOHN DEERE					
655C (EQUIPMENT)		6750 (AGRICULTURE) JDEERE 6125HZ		6920 (AGRICULTURE) 6068T , 2001	
Hydraulic Oil Filter.....	HC-62020	Hydraulic Oil Filter.....	HC-7939	Hydraulic Oil Filter.....	HC-76080
6600 (TRACTORS)		6750 (HARVESTERS)		6930 (AGRICULTURE) 6 CYL. , 2006	
Hydraulic Oil Filter.....	HC-76080	Hydraulic Oil Filter.....	HC-7939	Hydraulic Oil Filter.....	HC-76080
Hydraulic Oil Filter.....	HC-5508				
Hydraulic Oil Filter.....	HC-5504	675 (LOADERS)		693D (FELLER BUNCHERS)	
6605 (TRACTORS)		Hydraulic Oil Filter.....	HC-7925	Hydraulic Oil Filter.....	HC-5506
Hydraulic Oil Filter.....	HC-76080	Hydraulic Oil Filter.....	HC-5511	6950 (HARVESTERS)	
6610 (HARVESTERS)		675B (LOADERS)		Hydraulic Oil Filter.....	HC-7939
Hydraulic Oil Filter.....	HC-7939	Hydraulic Oil Filter.....	HC-7925	700 (CONSTRUCTION & MINING)	
Hydraulic Oil Filter.....	HC-5508	Hydraulic Oil Filter.....	HC-5511	Hydraulic Oil Filter.....	H-7601
Hydraulic Oil Filter.....	HC-76080	6810 (HARVESTERS)		Hydraulic Oil Filter.....	H-7601
6630 (AGRICULTURE) 6 CYL. , 2006		Hydraulic Oil Filter.....	HC-7939	700J LGP (CRAWLER DOZERS) JDEERE 6068T	
Hydraulic Oil Filter.....	HC-76080	6820 (AGRICULTURE) 6068T , 2001		Hydraulic Oil Filter.....	HC-5504
6650 (HARVESTERS)		Hydraulic Oil Filter.....	HC-76080	700A (LOADERS)	
Hydraulic Oil Filter.....	HC-7939	6830 (AGRICULTURE) 6 CYL. , 2006		Hydraulic Oil Filter.....	H-7601
670 (GRADERS)		Hydraulic Oil Filter.....	HC-76080	7020 (AGRICULTURE)	
Hydraulic Oil Filter.....	H-76070	6850 (AGRICULTURE) JDEERE 6125HZ		Hydraulic Oil Filter.....	H-7601
670C (GRADERS) JDEERE 6068		Hydraulic Oil Filter.....	HC-7939	Hydraulic Oil Filter.....	H-7601
Hydraulic Oil Filter.....	HC-7603	6850 (HARVESTERS)		710D (BACKHOE LOADERS) JDEERE 6068T	
670CH (GRADERS) JDEERE 6068		Hydraulic Oil Filter.....	HC-7939	Hydraulic Oil Filter.....	HC-7604
Hydraulic Oil Filter.....	HC-7603	6900 (TRACTORS) JDEERE 6 CYL		710G (BACKHOE LOADERS) JDEERE 4045 POWERTech	
670A (GRADERS)		Hydraulic Oil Filter.....	HC-5508	Hydraulic Oil Filter.....	HC-76070
Hydraulic Oil Filter.....	H-76070	Hydraulic Oil Filter.....	HC-5504	Hydraulic Oil Filter.....	HC-76110
670D (GRADERS)		Hydraulic Oil Filter.....	HC-76080	710J (LOADERS) JDEERE 6068T	
Hydraulic Oil Filter.....	HC-76070	690B (LOADERS)		Hydraulic Oil Filter.....	HC-76110
6710 (HARVESTERS)		Hydraulic Oil Filter.....	H-7601	710B (TRACTORS)	
Hydraulic Oil Filter.....	HC-7939	Hydraulic Oil Filter.....	H-51170	Hydraulic Oil Filter.....	H-76060
672CH (GRADERS) JDEERE 6068		690D (EXCAVATORS) JDEERE 6414T		710E (BACKHOE LOADERS)	
Hydraulic Oil Filter.....	HC-7603	Hydraulic Oil Filter.....	HC-5506	Hydraulic Oil Filter.....	HC-7604
Hydraulic Oil Filter.....	HC-7939	690D (EXCAVATORS)		7200 (AGRICULTURE) John Deere 6059 , 1997-2002	
672A (GRADERS)		Hydraulic Oil Filter.....	HC-5506	Hydraulic Oil Filter.....	HC-76080
Hydraulic Oil Filter.....	HC-7939	6910 (HARVESTERS)		7200 (TRACTORS)	
Hydraulic Oil Filter.....	H-76070	Hydraulic Oil Filter.....	HC-7939	Hydraulic Oil Filter.....	HC-5504
672B (GRADERS)		Hydraulic Oil Filter.....	HC-7939	Hydraulic Oil Filter.....	HC-76080
Hydraulic Oil Filter.....	HC-7939	6910S (TRACTORS)		7210 (TRACTORS)	
Hydraulic Oil Filter.....	H-76070	Hydraulic Oil Filter.....	HC-5504		



ENGINE APPLICATION

MODEL/APPLICATION	SAKURA NO	MODEL/APPLICATION	SAKURA NO	MODEL/APPLICATION	SAKURA NO
JOHN DEERE		JOHN DEERE		JOHN DEERE	
7210 (TRACTORS)		7460 (COTTON PICKERS)		Hydraulic Oil Filter.....	HC-5504
Hydraulic Oil Filter.....	HC-5504	Hydraulic Oil Filter.....	HC-5504	762 (SCRAPERS)	
7220 (TRACTORS)		748GII (SKIDDERS)		Hydraulic Oil Filter Transmission....	H-5109
Hydraulic Oil Filter.....	HC-5504	Hydraulic Oil Filter.....	HC-76090	7700 (TRACTORS)	
724J (LOADERS)		748GIII (SKIDDERS) S/N: 576603-UP		Hydraulic Oil Filter.....	HC-5504
Hydraulic Oil Filter Transmission..	HC-76130	Hydraulic Oil Filter.....	HC-76070	770C (GRADERS)	
Hydraulic Oil Filter.....	HC-7939	748H (LOADERS) DEERE 6081		Hydraulic Oil Filter.....	HC-7604
7320 (AGRICULTURE) John Deere , 1993-1996		Hydraulic Oil Filter.....	HC-76090	770CH (GRADERS)	
Hydraulic Oil Filter.....	HC-76080	750J (CRAWLER DOZERS) DEERE 6068H		Hydraulic Oil Filter.....	HC-7604
740 (CONSTRUCTION & MINING)		Hydraulic Oil Filter.....	HC-5504	770B (GRADERS)	
Hydraulic Oil Filter.....	H-7601	7510 (TRACTORS)		Hydraulic Oil Filter.....	HC-7604
Hydraulic Oil Filter.....	H-7601	Hydraulic Oil Filter.....	HC-5504	7710 POWERMODE (TRACTORS) DEERE 6081T , 2001-UP	
Hydraulic Oil Filter.....	H-76070	7520 (TRACTORS) 2006-UP		Hydraulic Oil Filter.....	HC-5504
7400 (AGRICULTURE) 1997-2002		Hydraulic Oil Filter.....	HC-5504	7710 (TRACTORS) S/N: T0-89999	
Hydraulic Oil Filter.....	HC-76080	7520 (AGRICULTURE) 2006		Hydraulic Oil Filter.....	HC-5504
7400 (TRACTORS)		Hydraulic Oil Filter.....	HC-5504	772B (GRADERS)	
Hydraulic Oil Filter.....	HC-5504	7520 (TRACTORS) 1975-UP		Hydraulic Oil Filter.....	HC-7939
Hydraulic Oil Filter.....	HC-76080	Hydraulic Oil Filter.....	H-7601	Hydraulic Oil Filter.....	HC-7604
7405 (TRACTORS)		7520 (AGRICULTURE) 1975		772CH (GRADERS)	
Hydraulic Oil Filter.....	HC-7602	Hydraulic Oil Filter.....	H-7601	Hydraulic Oil Filter.....	HC-7604
740A (SKIDDERS)		755C (CRAWLER LOADERS) LIEBHERR D926T		Hydraulic Oil Filter.....	HC-7939
Hydraulic Oil Filter.....	H-76070	Hydraulic Oil Filter.....	HC-62020	772A (GRADERS)	
7410 (TRACTORS)		756 (TRACTORS)		Hydraulic Oil Filter.....	HC-7939
Hydraulic Oil Filter.....	HC-5504	Hydraulic Oil Filter.....	HC-76100	7800 (TRACTORS)	
7420 (AGRICULTURE) John Deere , 1999-2002		760 (CONSTRUCTION & MINING)		Hydraulic Oil Filter.....	HC-5504
Hydraulic Oil Filter.....	HC-76080	Hydraulic Oil Filter.....	H-7601	Hydraulic Oil Filter.....	HC-5504
7420 (TRACTORS)		Hydraulic Oil Filter.....	H-7601	7920 (EQUIPMENT) 2004-UP	
Hydraulic Oil Filter.....	HC-5504	7600 (TRACTORS)		Hydraulic Oil Filter.....	HC-5504
743 (AGRICULTURE)		Hydraulic Oil Filter.....	HC-5504	7920 (AGRICULTURE) 2004	
Hydraulic Oil Filter.....	H-7601	760A (SCRAPERS)		Hydraulic Oil Filter.....	HC-5504
Hydraulic Oil Filter.....	H-76070	Hydraulic Oil Filter.....	H-7601	800C (EXCAVATORS)	
Hydraulic Oil Filter.....	H-7601	760SRA (SCRAPERS)		Hydraulic Oil Filter Full Flow.....	HC-7901
743A (HARVESTERS)		Hydraulic Oil Filter.....	H-7601	8010 (TRACTORS) DETROITD 6-71	
Hydraulic Oil Filter.....	H-76070	7610 (TRACTORS)		Hydraulic Oil Filter Transmission....	H-65030
744J (LOADERS)					
Hydraulic Oil Filter Transmission..	HC-76130				



ENGINE APPLICATION

MODEL/APPLICATION	SAKURA NO	MODEL/APPLICATION	SAKURA NO	MODEL/APPLICATION	SAKURA NO
JOHN DEERE		JOHN DEERE		JOHN DEERE	
80D (TRACTORS)		Hydraulic Oil Filter.....	HC-5507	8530 (TRACTORS) JDEERE , 2005-UP	
Hydraulic Oil Filter.....	H-7601	8330 (TRACTORS) 2006-UP		Hydraulic Oil Filter.....	HC-5506
8100T (TRACTORS)		Hydraulic Oil Filter.....	HC-5506	855 (TRACTORS)	
Hydraulic Oil Filter.....	HC-5507	840 (CONSTRUCTION & MINING)		Hydraulic Oil Filter.....	HC-76100
8110T (TRACTORS)		Hydraulic Oil Filter.....	H-7601	8560 (TRACTORS)	
Hydraulic Oil Filter.....	HC-5507	Hydraulic Oil Filter.....	H-7601	Hydraulic Oil Filter.....	HC-5506
8120T (TRACTORS)		Hydraulic Oil Filter.....	H-7601	856 (TRACTORS)	
Hydraulic Oil Filter.....	HC-5507	840D (TRACTORS)		Hydraulic Oil Filter.....	HC-76100
8130 (TRACTORS) 2006-UP		Hydraulic Oil Filter.....	H-7601	8570 (TRACTORS)	
Hydraulic Oil Filter.....	HC-5506	8401T (TRACTORS)		Hydraulic Oil Filter.....	HC-5506
820 MANNHEIM-BU (AGRICULTURE) 820 MANNHEIM-BUILT		Hydraulic Oil Filter.....	HC-5507	860 (CONSTRUCTION & MINING)	
Hydraulic Oil Filter.....	H-7601	8410T (TRACTORS)		Hydraulic Oil Filter.....	H-7601
8200T (TRACTORS)		Hydraulic Oil Filter.....	HC-5507	Hydraulic Oil Filter.....	H-7601
Hydraulic Oil Filter.....	HC-5507	8420T (TRACTORS)		860B (SCRAPERS)	
820 MANNHEIM-BUILT (TRACTORS)		Hydraulic Oil Filter.....	HC-5507	Hydraulic Oil Filter.....	H-7601
Hydraulic Oil Filter.....	H-7601	8430 (TRACTORS) 2006-UP		8630 (AGRICULTURE)	
820VU (TRACTORS)		Hydraulic Oil Filter.....	HC-5506	Hydraulic Oil Filter.....	H-7601
Hydraulic Oil Filter.....	H-7601	8430 (TRACTORS) 1975-1978		Hydraulic Oil Filter.....	H-76060
8210T (TRACTORS)		Hydraulic Oil Filter.....	H-76060	Hydraulic Oil Filter.....	H-7601
Hydraulic Oil Filter.....	HC-5507	Hydraulic Oil Filter.....	H-7601	8640 (TRACTORS)	
8220T (TRACTORS)		843G (FELLER BUNCHERS)		Hydraulic Oil Filter.....	H-76060
Hydraulic Oil Filter.....	HC-5507	Hydraulic Oil Filter.....	HC-7604	870 (TRACTORS)	
8230T (TRACTORS) JDEERE 6090 , 2006-UP		8440 (TRACTORS)		Hydraulic Oil Filter.....	HC-5506
Hydraulic Oil Filter.....	HC-5507	Hydraulic Oil Filter.....	H-76060	870G (DOZERS) JDEERE 6090H	
824J (LOADERS)		844J (LOADERS) JDEERE 6125 POWERTECH		Hydraulic Oil Filter.....	HC-76070
Hydraulic Oil Filter Transmission...	HC-76130	Hydraulic Oil Filter Transmission...	HC-76130	8760 (TRACTORS)	
830 (AGRICULTURE)		848H (LOADERS) JDEERE 6081		Hydraulic Oil Filter.....	HC-5506
Hydraulic Oil Filter.....	H-7601	Hydraulic Oil Filter.....	HC-76090	8770 (TRACTORS)	
Hydraulic Oil Filter.....	H-7601	850 (TRACTORS) JDEERE		Hydraulic Oil Filter.....	HC-5506
8301 (TRACTORS) JDEERE DIESEL		Hydraulic Oil Filter.....	HC-5511	8960 (TRACTORS)	
Hydraulic Oil Filter.....	H-7601	850B (CRAWLER DOZERS)		Hydraulic Oil Filter.....	HC-5506
8310T (TRACTORS)		Hydraulic Oil Filter.....	H-76060	8970 (TRACTORS)	
Hydraulic Oil Filter.....	HC-5507	850J (CRAWLER DOZERS) JDEERE 6090H		Hydraulic Oil Filter.....	HC-5506
8320T (TRACTORS)		Hydraulic Oil Filter.....	HC-5504	9100 (TRACTORS)	
Hydraulic Oil Filter.....	HC-5507	8520T (TRACTORS)		Hydraulic Oil Filter.....	HC-5508
		Hydraulic Oil Filter.....	HC-5507		



ENGINE APPLICATION

MODEL/APPLICATION	SAKURA NO	MODEL/APPLICATION	SAKURA NO	MODEL/APPLICATION	SAKURA NO
JOHN DEERE		JOHN DEERE		JOHN DEERE	
9100T (TRACTORS) JDEERE 6081		955 (TRACTORS)		Hydraulic Oil Filter.....	H-7601
Hydraulic Oil Filter.....	HC-76080	Hydraulic Oil Filter.....	HC-76100	(TRACTORS) JDEERE DIESEL	
9120 (TRACTORS)		9620 (TRACTORS)		Hydraulic Oil Filter.....	H-7601
Hydraulic Oil Filter.....	HC-5504	Hydraulic Oil Filter.....	HC-5504	TC44H (LOADERS) JDEERE	
920 (AGRICULTURE)		9620T (TRACTORS) 2005-UP		Hydraulic Oil Filter.....	HC-7603
Hydraulic Oil Filter.....	H-7601	Hydraulic Oil Filter.....	HC-5507	TC54H (LOADERS) JDEERE	
Hydraulic Oil Filter.....	H-7601	9910 (AGRICULTURE)		Hydraulic Oil Filter.....	HC-7603
9200 (TRACTORS)		Hydraulic Oil Filter.....	HC-7932	TC62H (LOADERS) JDEERE	
Hydraulic Oil Filter.....	HC-5508	992E-LC (EXCAVATORS)		Hydraulic Oil Filter.....	HC-7603
9220 (TRACTORS)		Hydraulic Oil Filter Full Flow.....	HC-7901	Z920R (MOWERS) FX 50 VK50VE , 700	
Hydraulic Oil Filter.....	HC-5504	Hydraulic Oil Filter.....	H-2709	Hydraulic Oil Filter Transmission...	HC-76150
9230 (TRACTORS) JDEERE 6090 , 2006-UP		F1145 (LAWN EQUIPMENT)		Z960R (MOWERS) FX 50 VK50VE , 1000	
Hydraulic Oil Filter.....	HC-5504	Hydraulic Oil Filter.....	HC-76100	Hydraulic Oil Filter Transmission...	HC-76150
9300T (TRACTORS)		JD400 (LOADERS)		KAESER	
Hydraulic Oil Filter.....	HC-5504	Hydraulic Oil Filter.....	H-7601	DSD 171 (AIR COMPRESSORS) 2001-2005	
Hydraulic Oil Filter.....	HC-5507	JD410E (LOADERS) JDEERE 4045T		Hydraulic Oil Filter.....	HC-7964
930VU (TRACTORS)		Hydraulic Oil Filter.....	HC-76110	DSD 171 (AIR COMPRESSORS) 2000	
Hydraulic Oil Filter.....	H-7601	JD415 (BACKHOE LOADERS)		Hydraulic Oil Filter.....	HC-7964
9320 (TRACTORS)		Hydraulic Oil Filter.....	H-76060	DSD 171 (AIR COMPRESSORS) 1999	
Hydraulic Oil Filter.....	HC-5504	JD550H (DOZERS) JDEERE 4045 POWERTECH		Hydraulic Oil Filter.....	HC-7964
9320T (TRACTORS)		Hydraulic Oil Filter.....	HC-5504	MOBILAIR 75 (AIR COMPRESSORS) DEUTZ F4L913	
Hydraulic Oil Filter.....	HC-5507	JD646B (COMPACTORS)		Hydraulic Oil Filter.....	HC-6802
Hydraulic Oil Filter.....	HC-5504	Hydraulic Oil Filter.....	H-7601	MOBILAIR 75 (AIR COMPRESSORS) DEUTZ F4L912	
9330 (TRACTORS) JDEERE 6135		JD646 (COMPACTORS)		Hydraulic Oil Filter.....	HC-6802
Hydraulic Oil Filter.....	HC-5504	Hydraulic Oil Filter.....	H-7601	KALMAR	
940 (AGRICULTURE)		JD646C (COMPACTORS)		DC16 T330121240 (FORKLIFTS)	
Hydraulic Oil Filter.....	H-7601	Hydraulic Oil Filter.....	H-7601	Hydraulic Oil Filter.....	H-7961
Hydraulic Oil Filter.....	H-7601	JD650H (DOZERS) JDEERE 4045 POWERTECH		DCB28 RORO (FORKLIFTS) VOLVO TWD731	
Hydraulic Oil Filter.....	H-76070	Hydraulic Oil Filter.....	HC-5504	Hydraulic Oil Filter.....	H-42020
9400T (TRACTORS)		JD770B (GRADERS)		DCB421200G (FORKLIFTS)	
Hydraulic Oil Filter.....	HC-5507	Hydraulic Oil Filter.....	HC-7604	Hydraulic Oil Filter.....	HC-7925
Hydraulic Oil Filter.....	HC-5504	JD772B (GRADERS)		DCD1006 (FORKLIFTS) VOLVO	
9420 (TRACTORS)		Hydraulic Oil Filter.....	HC-7604	Hydraulic Oil Filter Transmission....	H-5109
Hydraulic Oil Filter.....	HC-5504	9530 (TRACTORS) JDEERE 6135		DCD806 (FORKLIFTS)	
Hydraulic Oil Filter.....	HC-5504	Hydraulic Oil Filter.....	HC-5504	Hydraulic Oil Filter.....	HC-7913
		(TRACTORS) JDEERE 4276 DIESEL			



ENGINE APPLICATION

MODEL/APPLICATION	SAKURA NO	MODEL/APPLICATION	SAKURA NO	MODEL/APPLICATION	SAKURA NO
KALMAR		KHD (KLOCKNER-HUMBOLT-DEUTZ)		KOBELCO	
DCD806 (<i>FORKLIFTS</i>)		D4007 (<i>TRACTORS</i>) DEUTZ F3L912 , 1978-1986		K903B (<i>EXCAVATORS</i>) ISUZU C240 (S/N: LE3401-5700)	
Hydraulic Oil Filter.....	HC-7925	Hydraulic Oil Filter.....	HC-1822	Hydraulic Oil Filter.....	H-5211
DRD1005256 (<i>FORKLIFTS</i>)		D4507C (<i>TRACTORS</i>) DEUTZ F4L912 , 1982-1985		K903C (<i>EXCAVATORS</i>) ISUZU 43B1 (S/N: LE5701-6600)	
Hydraulic Oil Filter.....	HC-7925	Hydraulic Oil Filter.....	HC-1822	Hydraulic Oil Filter.....	H-5211
PT122 (<i>TRUCKS</i>) CUMMINS QSB5.9 (S/N: 21747147-UP) , 2008-UP		M1302 (<i>COMBINES</i>) DEUTZ F6L912		K903II (<i>EXCAVATORS</i>) ISUZU 43B1 (S/N: LE6601-7871)	
Hydraulic Oil Filter Transmission..	H-8537-S	Hydraulic Oil Filter.....	HC-6801	Hydraulic Oil Filter.....	H-5211
KAROSA		M1320 (<i>COMBINES</i>) DEUTZ F6L913		K903II (<i>EXCAVATORS</i>) ISUZU 43B1 (S/N: LE7872-11000)	
B950 (<i>BUSES</i>) IVECO CURSOR 8 , 2004-UP		Hydraulic Oil Filter.....	HC-6801	Hydraulic Oil Filter.....	H-5211
Hydraulic Oil Filter Transmission....	H-7102	M3580 (<i>COMBINES</i>) DEUTZ BF6L913		K904C (<i>LOADERS</i>) MITSUBISHI 6D14C (S/N: K13609-13609)	
KATO		Hydraulic Oil Filter.....	HC-62020	Hydraulic Oil Filter.....	H-5609
HD180G (<i>CRANES</i>) MITSUBISHI 4DR5		(<i>ENGINES</i>) KHD F4L913		K904C (<i>LOADERS</i>) MITSUBISHI 6D14C (S/N: LW5269-5800)	
Hydraulic Oil Filter.....	H-7914	Hydraulic Oil Filter.....	HC-1822	Hydraulic Oil Filter.....	H-5609
HD180G (<i>CRANES</i>) MITSUBISHI 4DR5C		(<i>ENGINES</i>) KHD F4L912		K904D (<i>EXCAVATORS</i>) ISUZU 4BD1 (S/N: LW5801-7800)	
Hydraulic Oil Filter.....	H-7914	Hydraulic Oil Filter.....	HC-1822	Hydraulic Oil Filter.....	H-5211
HD249 (<i>CRANES</i>) MITSUBISHI 4D31		(<i>ENGINES</i>) KHD F3L912		K904E (<i>EXCAVATORS</i>) ISUZU 4BD1 (S/N: LW7801-UP)	
Hydraulic Oil Filter.....	H-7914	Hydraulic Oil Filter.....	HC-1822	Hydraulic Oil Filter.....	H-5211
HD300GS1 (<i>CRANES</i>) MITSUBISHI 4D31CT		(<i>ENGINES</i>) KHD BF4L913		K904II (<i>EXCAVATORS</i>) ISUZU 4BD1 (S/N: YW0101-2800)	
Hydraulic Oil Filter.....	H-7914	Hydraulic Oil Filter.....	HC-6802	Hydraulic Oil Filter.....	H-5211
HD400V2 (<i>CRANES</i>) MITSUBISHI 4D31T		(<i>ENGINES</i>) KHD F5L913		K904LCII (<i>EXCAVATORS</i>) ISUZU 4BD1 (S/N: LX1501-UP)	
Hydraulic Oil Filter.....	H-7914	Hydraulic Oil Filter.....	HC-6802	Hydraulic Oil Filter.....	H-5211
KAWASAKI		(<i>ENGINES</i>) KHD F6L913		K905 (<i>EXCAVATORS</i>) ISUZU 6BB1 (S/N: LP0004-0554)	
65TMV (<i>LOADERS</i>) w/Cummins Eng		Hydraulic Oil Filter.....	HC-6802	Hydraulic Oil Filter.....	H-5211
Hydraulic Oil Filter.....	H-5519	KNUDSON		K905 (<i>EXCAVATORS</i>) ISUZU 6BB1 (S/N: LP0601-1600)	
65ZV (<i>LOADERS</i>) w/Cummins Eng		310H (<i>TRACTORS</i>) CUMMINS NT-855		Hydraulic Oil Filter.....	H-5211
Hydraulic Oil Filter.....	H-5519	Hydraulic Oil Filter.....	H-51170	K905A/ALC (<i>EXCAVATORS</i>) ISUZU 4BD1 (S/N: LP1601-UP)	
KENWORTH		KOBELCO		Hydraulic Oil Filter.....	H-5211
T300 (<i>TRUCKS</i>) CAT 3126B , 1996-UP		45SR-2 (<i>EXCAVATORS</i>) w/Yanmar 2.2L (133 CID) Eng , 2200		K905A/ALC (<i>EXCAVATORS</i>) ISUZU 4BD1 (S/N: YP0301-UP)	
Hydraulic Oil Filter Transmission..	H-8537-S	Hydraulic Oil Filter.....	H-5519	Hydraulic Oil Filter.....	H-5211
KHD (KLOCKNER-HUMBOLT-DEUTZ)		7065 (<i>CONSTRUCTION & MINING</i>) MITSUBISHI 6D22		K905A/LC (<i>EXCAVATORS</i>) ISUZU 4BD1 (S/N: KP1601-UP)	
ACTOR 5520H (<i>COMBINES</i>) KHD BF6L913 , 1999-UP		Hydraulic Oil Filter.....	H-5211	Hydraulic Oil Filter.....	H-5211
Hydraulic Oil Filter.....	HC-62020	Hydraulic Oil Filter Full Flow.....	HC-7901	K905A/LC (<i>EXCAVATORS</i>) ISUZU 4BD1 (S/N: YP0301-UP)	
AGROSUN 100 (<i>TRACTORS</i>) KHD BF6L913T		7065 (<i>CRANES</i>) MITSUBISHI 6D22		Hydraulic Oil Filter.....	H-5211
Hydraulic Oil Filter.....	HC-51040	Hydraulic Oil Filter.....	H-5211	K905A/LC (<i>EXCAVATORS</i>) ISUZU 6BB1 (S/N: LP0601-UP)	
AGROLUX 60 (<i>TRACTORS</i>) KHD F3L913 , 2001-UP		Hydraulic Oil Filter Full Flow.....	HC-7901	Hydraulic Oil Filter.....	H-5211
Hydraulic Oil Filter.....	HC-1822				



ENGINE APPLICATION

MODEL/APPLICATION	SAKURA NO	MODEL/APPLICATION	SAKURA NO	MODEL/APPLICATION	SAKURA NO
KOBELCO		KOBELCO		KOBELCO	
K905LC (EXCAVATORS) ISUZU 68B1 (S/N: LP0901-LP1376)		K909A (EXCAVATORS) MITSUBISHI 6D22C (S/N: LQ1063-LQ1324)		K914 (EXCAVATORS) MITSUBISHI 8DC8 (S/N: LR0186-UP)	
Hydraulic Oil Filter.....	H-5211	Hydraulic Oil Filter Full Flow.....	HC-7901	Hydraulic Oil Filter.....	H-5211
K905LC (EXCAVATORS) ISUZU 68B1 (S/N: YP0115-0300)		K909A (EXCAVATORS) MITSUBISHI 6D22C (S/N: LL01001-UP)		K916LC (EXCAVATORS) MITSUBISHI 6D22CT (S/N: YS0119-YS0200)	
Hydraulic Oil Filter.....	H-5211	Hydraulic Oil Filter.....	H-5211	Hydraulic Oil Filter Full Flow.....	HC-7901
K905LCII (EXCAVATORS) ISUZU 4BD1T (S/N: YP1001-YP1281)		K909A (EXCAVATORS) MITSUBISHI 6D22C (S/N: LQ1325-UP)		K916LC (EXCAVATORS) MITSUBISHI 6D22CT (S/N: LS0007-UP)	
Hydraulic Oil Filter.....	H-5211	Hydraulic Oil Filter Full Flow.....	HC-7901	Hydraulic Oil Filter Full Flow.....	HC-7901
K905LCII (EXCAVATORS) ISUZU 4BD1T (S/N: YP1282-YP0300)		K909A (EXCAVATORS) MITSUBISHI 6D22C (S/N: LQ1325-UP)		K916LCII (EXCAVATORS) MITSUBISHI 6D22CT (S/N: YS0201-UP)	
Hydraulic Oil Filter.....	H-5211	Hydraulic Oil Filter Full Flow.....	HC-7901	Hydraulic Oil Filter.....	H-5211
K907B (EXCAVATORS) DETROIT DIESEL S/N: ALL-UP		K909LCII (EXCAVATORS) MITSUBISHI 6D15T (S/N: LL1207-1318)		K935 (EXCAVATORS) GMC 6-71N (S/N: L70129-LU0085)	
Hydraulic Oil Filter.....	H-5622	Hydraulic Oil Filter.....	H-5211	Hydraulic Oil Filter.....	H-5609
Hydraulic Oil Filter.....	H-5211	Hydraulic Oil Filter Full Flow.....	HC-7901	Hydraulic Oil Filter.....	H-5211
K907B (EXCAVATORS) DETROIT DIESEL S/N: APR-71-UP		K909LCII (EXCAVATORS) MITSUBISHI 6D15T (S/N: LL1319-LLU0300)		K935 (EXCAVATORS) MITSUBISHI 6D22C (S/N: L70106-L70124)	
Hydraulic Oil Filter.....	H-5211	Hydraulic Oil Filter.....	H-5211	Hydraulic Oil Filter.....	H-5211
Hydraulic Oil Filter.....	H-5622	Hydraulic Oil Filter Full Flow.....	HC-7901	Hydraulic Oil Filter.....	H-5609
K907B (EXCAVATORS) GMC 4-71		K907C TURBO (EXCAVATORS) MITSUBISHI 6D15T		K935 (EXCAVATORS) MITSUBISHI 6D22C (S/N: LU0086-LU0145)	
Hydraulic Oil Filter.....	H-5622	Hydraulic Oil Filter.....	H-5211	Hydraulic Oil Filter.....	H-5609
Hydraulic Oil Filter.....	H-5211	K912A (EXCAVATORS) MITSUBISHI 6D22T (S/N: LC2003-2016)		Hydraulic Oil Filter.....	H-5211
K907C (EXCAVATORS) MITSUBISHI 6D15C (S/N: LN4201-7000)		Hydraulic Oil Filter Full Flow.....	HC-7901	K935 (EXCAVATORS) MITSUBISHI 6D22C (S/N: LU0146-UP)	
Hydraulic Oil Filter.....	H-5211	Hydraulic Oil Filter.....	H-5211	Hydraulic Oil Filter.....	H-5609
K907CLC (EXCAVATORS) MITSUBISHI 6D15T (S/N: YG0101-0500)		K912A/ALC (EXCAVATORS) MITSUBISHI 6D22CT (S/N: LC2017-2300)		Hydraulic Oil Filter.....	H-5211
Hydraulic Oil Filter.....	H-5211	Hydraulic Oil Filter.....	H-5211	Hydraulic Oil Filter.....	H-5211
K907D (EXCAVATORS) MITSUBISHI 6D14T (S/N: LN7001-UP)		K912A/ALC (EXCAVATORS) MITSUBISHI 6D22CT (S/N: YC0103-0300)		KW904 (EXCAVATORS) ISUZU 68B1 (S/N: YD01012-UP)	
Hydraulic Oil Filter.....	H-5211	Hydraulic Oil Filter Full Flow.....	HC-7901	Hydraulic Oil Filter.....	H-5211
K907D (EXCAVATORS) MITSUBISHI 6D14T (S/N: YG0501-UP)		Hydraulic Oil Filter.....	H-5211	MD140BLC (EXCAVATORS) MITSUBISHI 4D31T (S/N: YP1001-YP0300)	
Hydraulic Oil Filter.....	H-5211	K912LCII (EXCAVATORS) MITSUBISHI 6D22T (S/N: YC0301-YC0737)		Hydraulic Oil Filter.....	H-5211
K907LCII (EXCAVATORS) MITSUBISHI 6D31T (S/N: YQ0101-YQU0400)		Hydraulic Oil Filter Full Flow.....	HC-7901	MD180LC (EXCAVATORS) MITSUBISHI 6D14T (S/N: YG00647-UP)	
Hydraulic Oil Filter.....	H-5211	K912LCII (EXCAVATORS) MITSUBISHI 6D22CT (S/N: LC2301-UP)		Hydraulic Oil Filter.....	H-5211
K909 (EXCAVATORS) DETROIT DIESEL (S/N: ALL-JUN-71)		Hydraulic Oil Filter.....	H-5211	MD120LC (EXCAVATORS) MITSUBISHI 4D31T (S/N: YP0417-UP)	
Hydraulic Oil Filter.....	H-5609	Hydraulic Oil Filter Full Flow.....	HC-7901	Hydraulic Oil Filter.....	H-5211
Hydraulic Oil Filter Full Flow.....	HC-7901	K912LCII (EXCAVATORS) MITSUBISHI 6D22CT (S/N: YC0301-UP)		MD200CLC (EXCAVATORS) MITSUBISHI 6D31T (S/N: YQU0401-0700)	
K909 (EXCAVATORS) GMC 6-71		Hydraulic Oil Filter Full Flow.....	HC-7901	Hydraulic Oil Filter.....	H-5211
Hydraulic Oil Filter.....	H-5609	Hydraulic Oil Filter.....	H-5211	MD240 (EXCAVATORS) KOBELCO	
Hydraulic Oil Filter.....	H-5211	K914 (EXCAVATORS) GMC 8V-71 (S/N: LR0143-LR0145)		Hydraulic Oil Filter Full Flow.....	HC-7901
K909A (EXCAVATORS) MITSUBISHI 6D22C (S/N: LQ0795-1062)		Hydraulic Oil Filter.....	H-5211	SK100 (EXCAVATORS) ISUZU 4BD1 (S/N: YW2801-YW4600)	
Hydraulic Oil Filter.....	H-5211	K914 (EXCAVATORS) MITSUBISHI 8DC8 (S/N: LR0146-LR0185)		Hydraulic Oil Filter.....	H-5211
Hydraulic Oil Filter Full Flow.....	HC-7901	Hydraulic Oil Filter.....	H-5211	SK120LC (EXCAVATORS) ISUZU 4BD1T (S/N: YPU0301-YPU0359)	



ENGINE APPLICATION

MODEL/APPLICATION	SAKURA NO	MODEL/APPLICATION	SAKURA NO	MODEL/APPLICATION	SAKURA NO
KOBELCO		KOBELCO		KOMATSU	
SK120LC (EXCAVATORS) ISUZU 4BD1T (S/N: YPU0301-YPU0359) Hydraulic Oil Filter.....	H-5211	Hydraulic Oil Filter.....	H-5211	Hydraulic Oil Filter.....	H-5610
SK120LCIII (EXCAVATORS) ISUZU 4BD1T (S/N: YPU0301-0569) Hydraulic Oil Filter.....	H-5211	Hydraulic Oil Filter Full Flow.....	HC-7901	Hydraulic Oil Filter.....	H-56600
SK150 (EXCAVATORS) Hydraulic Oil Filter.....	H-5211	SK220LCIII (EXCAVATORS) MITSUBISHI 6D15T (S/N: LLU0384-0634) Hydraulic Oil Filter Full Flow.....	HC-7901	100L-2 (EXCAVATORS) S4D105-5 Hydraulic Oil Filter.....	H-56600
SK200-2 ACERA (EXCAVATORS) MITSUBISHI 6D31T (S/N: YN18001-22848) Hydraulic Oil Filter.....	H-7911	SK220LCIII (EXCAVATORS) MITSUBISHI 6D15T (S/N: LLU0635-1200) Hydraulic Oil Filter Full Flow.....	HC-7901	100N1 (EXCAVATORS) S4D105-5 Hydraulic Oil Filter.....	H-5610
SK200-2 ACERA (EXCAVATORS) MITSUBISHI 6D31T (S/N: YQ02301-02654) Hydraulic Oil Filter.....	H-7911	SK250LC (EXCAVATORS) MITSUBISHI 6D34 Hydraulic Oil Filter.....	H-7911	Hydraulic Oil Filter.....	H-56600
SK200-3 ACERA (EXCAVATORS) MITSUBISHI 6D34T (S/N: YN23301-UP) Hydraulic Oil Filter.....	H-7911	SK40SR (EXCAVATORS) w/Yanmar 4TNE84 Eng Hydraulic Oil Filter.....	H-5519	100U-2 (EXCAVATORS) S4D105-5 Hydraulic Oil Filter.....	H-56600
SK200-3 ACERA (EXCAVATORS) MITSUBISHI 6D34T (S/N: YNT0001-UP) Hydraulic Oil Filter.....	H-7911	SK45SR (EXCAVATORS) w/Yanmar 2.2L (133 CID) Eng , 2200 Hydraulic Oil Filter.....	H-5519	Hydraulic Oil Filter.....	H-5610
SK200-3 ACERA (EXCAVATORS) MITSUBISHI 6D34T (S/N: YQ02801-UP) Hydraulic Oil Filter.....	H-7911	SK45SR-2 (EXCAVATORS) w/Yanmar 2.2L (133 CID) Eng , 2200 Hydraulic Oil Filter.....	H-5519	10HQ-2 (SHOVELS) 4D92 Hydraulic Oil Filter.....	H-5607
SK200-3 ACERA (EXCAVATORS) MITSUBISHI 6D34T (S/N: YQT0001-UP) Hydraulic Oil Filter.....	H-7911	SK60 (EXCAVATORS) ISUZU 4J31 (S/N: LE11001-17595) Hydraulic Oil Filter.....	H-5211	10HT (SHOVELS) 4D130-1 Hydraulic Oil Filter.....	H-5611
SK200LC (EXCAVATORS) MITSUBISHI 6D31T (S/N: YQU0401-YQU0500) Hydraulic Oil Filter.....	H-5211	SK60IV (EXCAVATORS) ISUZU 4J31 (S/N: LE17596-17700) Hydraulic Oil Filter.....	H-5211	10HT (SHOVELS) 4D92 Hydraulic Oil Filter.....	H-5607
SK200LCIII (EXCAVATORS) MITSUBISHI 6D31T (S/N: YQU0701-0834) Hydraulic Oil Filter.....	H-5211	KOEHRING BOMAG		10HW-2 (SHOVELS) 4D92 Hydraulic Oil Filter.....	H-5607
SK210 (EXCAVATORS) MITSUBISHI Hydraulic Oil Filter.....	H-7911	6036 (FORKLIFTS) CUMMINS NATURAL Hydraulic Oil Filter.....	HC-7913	10HQ (SHOVELS) 4D130-1 Hydraulic Oil Filter.....	H-5611
SK210LC (EXCAVATORS) MITSUBISHI (S/N: YOJ00101/YNJ00501-UP) Hydraulic Oil Filter.....	H-7911	6036 (FORKLIFTS) CUMMINS TURBO Hydraulic Oil Filter.....	HC-7913	10HW-1 (SHOVELS) 4D130-1 Hydraulic Oil Filter.....	H-5611
SK220LC (EXCAVATORS) MITSUBISHI 6D15T (S/N: LLU0301-LLU0383) Hydraulic Oil Filter Full Flow.....	HC-7901	6036 (FORKLIFTS) PERKINS NATURAL Hydraulic Oil Filter.....	HC-7913	111A (GRADERS) 4-71N Hydraulic Oil Filter Transmission....	H-65030
Hydraulic Oil Filter.....	H-5211	6036 (FORKLIFTS) PERKINS TURBO Hydraulic Oil Filter.....	HC-7913	118 SERIES B (GRADERS) 4-71 Hydraulic Oil Filter Transmission....	H-65030
SK220LC (EXCAVATORS) MITSUBISHI 6D15T (S/N: LLU0384-LLU0634) Hydraulic Oil Filter Full Flow.....	HC-7901	KOKUM		118 SERIES B (GRADERS) H-135CL/7601 Hydraulic Oil Filter Transmission....	H-65030
Hydraulic Oil Filter.....	H-5211	KL425 (CONSTRUCTION EQUIPMENTS) Hydraulic Oil Filter Transmission....	H-65030	118 SERIES B (GRADERS) NHC4/7601 Hydraulic Oil Filter Transmission....	H-65030
SK220LC (EXCAVATORS) MITSUBISHI 6D15T (S/N: LLU0638-UP) Hydraulic Oil Filter Full Flow.....	HC-7901	Hydraulic Oil Filter.....	H-71140	120-1 (EXCAVATORS) S4D105-5 Hydraulic Oil Filter.....	H-56600
SK220LC (EXCAVATORS) MITSUBISHI 6D15T (S/N: LLU0638-UP) Hydraulic Oil Filter Full Flow.....	HC-7901	KOMATSU		Hydraulic Oil Filter.....	H-5610
SK220LCIII (EXCAVATORS) MITSUBISHI 6D15T (S/N: LLU0301-0383)		100-2 (EXCAVATORS) S4D105-5 Hydraulic Oil Filter.....	H-5610	125B (SHOVELS) BD264 Hydraulic Oil Filter Transmission....	H-65030
		Hydraulic Oil Filter Full Flow.....	HC-7901		
		100L-1 (EXCAVATORS) S4D105-5			



ENGINE APPLICATION

MODEL/APPLICATION	SAKURA NO	MODEL/APPLICATION	SAKURA NO	MODEL/APPLICATION	SAKURA NO
KOMATSU		KOMATSU		KOMATSU	
160 (GRADERS) 6-71		229G (GRADERS) 8V-71T		Hydraulic Oil Filter.....	H-5405
Hydraulic Oil Filter Transmission...	H-65030	Hydraulic Oil Filter Transmission...	H-65030	270 (GRADERS) DVT-573	
160 Series A (GRADERS) 6-71		240 (LOADERS)		Hydraulic Oil Filter Transmission...	H-65030
Hydraulic Oil Filter Transmission...	H-65030	Hydraulic Oil Filter.....	H-5405	270A (LOADERS)	
160 SERIES C (GRADERS) 6-71		240A (LOADERS)		Hydraulic Oil Filter.....	H-5410
Hydraulic Oil Filter Transmission...	H-65030	Hydraulic Oil Filter.....	H-5410	Hydraulic Oil Filter.....	H-5406
160 SERIES L (GRADERS) 6-71		2404 (LOADERS)		295 (GRADERS) DT817	
Hydraulic Oil Filter Transmission...	H-65030	Hydraulic Oil Filter.....	H-5405	Hydraulic Oil Filter Transmission...	H-65030
165 (LOADERS) D310		2424 LO BOY (LOADERS)		295 SERIES B (GRADERS)	
Hydraulic Oil Filter Transmission...	H-65030	Hydraulic Oil Filter.....	H-5405	Hydraulic Oil Filter Transmission...	H-65030
175B (LOADERS) D361		2444 LO BOY (LOADERS)		300-2 (EXCAVATORS) NT-855	
Hydraulic Oil Filter.....	H-5405	Hydraulic Oil Filter.....	H-5405	Hydraulic Oil Filter.....	H-7911
175B (LOADERS) DT407		250 (LOADERS) DT429		300LC-1 (EXCAVATORS) NT-855	
Hydraulic Oil Filter.....	H-5405	Hydraulic Oil Filter.....	H-5405	Hydraulic Oil Filter.....	H-7911
175B (LOADERS) UD-407		2504 (LOADERS)		3000 LOADER MOUNTED (LOADERS)	
Hydraulic Oil Filter.....	H-5405	Hydraulic Oil Filter.....	H-5405	Hydraulic Oil Filter.....	H-5405
175C (LOADERS) DT466		2500A (LOADERS)		330 (GRADERS) CUMMINS	
Hydraulic Oil Filter.....	H-5406	Hydraulic Oil Filter.....	H-5410	Hydraulic Oil Filter Transmission...	H-65030
175C (LOADERS) DT466B		250A (LOADERS)		330H (GRADERS) CUMMINS	
Hydraulic Oil Filter.....	H-5406	Hydraulic Oil Filter.....	H-5410	Hydraulic Oil Filter Transmission...	H-65030
2000 LOADER MOUNTED (LOADERS)		Hydraulic Oil Filter.....	H-5406	340 (LOADERS)	
Hydraulic Oil Filter.....	H-5405	250B (LOADERS) DT429		Hydraulic Oil Filter.....	H-5405
2050 LOADER MOUNTED (LOADERS)		Hydraulic Oil Filter.....	H-5405	35 (CONSTRUCTION EQUIPMENTS) DETROIT DIESEL	
Hydraulic Oil Filter.....	H-5405	250C (LOADERS) DVT-573B		Hydraulic Oil Filter Transmission...	H-65030
210LC (EXCAVATORS)		Hydraulic Oil Filter.....	H-5403	35 (CONSTRUCTION EQUIPMENTS) NT-380	
Hydraulic Oil Filter.....	H-7911	2514B (LOADERS)		Hydraulic Oil Filter Transmission...	H-65030
220-2 (EXCAVATORS) S6D105-1		Hydraulic Oil Filter.....	H-5410	35C (CONSTRUCTION EQUIPMENTS) DETROIT DIESEL	
Hydraulic Oil Filter.....	H-7911	252FT (GRADERS) REAR ENGINE		Hydraulic Oil Filter Transmission...	H-65030
Hydraulic Oil Filter.....	H-5609	Hydraulic Oil Filter Transmission...	H-65030	3964B (EXCAVATORS) D358	
220LC-3 (EXCAVATORS) S6D105-1		260A (LOADERS)		Hydraulic Oil Filter.....	H-5406
Hydraulic Oil Filter.....	H-5609	Hydraulic Oil Filter.....	H-5410	3964B-LGP (EXCAVATORS) D358	
Hydraulic Oil Filter.....	H-7911	2606 (LOADERS)		Hydraulic Oil Filter.....	H-5406
222G (GRADERS) 8V-71T		Hydraulic Oil Filter.....	H-5405	3965B (EXCAVATORS) D358	
Hydraulic Oil Filter Transmission...	H-65030	2605 (LOADERS)		Hydraulic Oil Filter.....	H-5406



ENGINE APPLICATION

MODEL/APPLICATION	SAKURA NO	MODEL/APPLICATION	SAKURA NO	MODEL/APPLICATION	SAKURA NO
KOMATSU		KOMATSU		KOMATSU	
3984 (EXCAVATORS) D358		515C (LOADERS) D358		Hydraulic Oil Filter.....	H-5607
Hydraulic Oil Filter.....	H-5406	Hydraulic Oil Filter.....	H-5403	650R-3 (GRADERS) S/N: 24001	
		Hydraulic Oil Filter.....	HC-5402	Hydraulic Oil Filter.....	H-5620
3984B (EXCAVATORS) D358		520B (LOADERS) D359T		655-3 (GRADERS) 34001	
Hydraulic Oil Filter.....	H-5406	Hydraulic Oil Filter.....	H-5403	Hydraulic Oil Filter.....	H-5620
401 LO-BOY (LOADERS)		520C (LOADERS) D359T		660B (GRADERS) CUMMINS	
Hydraulic Oil Filter.....	H-5405	Hydraulic Oil Filter.....	H-5403	Hydraulic Oil Filter Transmission...	H-65030
404 (LOADERS)		520CH (LOADERS) D359T		666 (GRADERS) CUMMINS	
Hydraulic Oil Filter.....	H-5405	Hydraulic Oil Filter.....	H-5403	Hydraulic Oil Filter Transmission...	H-65030
424 (LOADERS)		530 (LOADERS) S6D105		777 (GRADERS) CUMMINS	
Hydraulic Oil Filter.....	H-5405	Hydraulic Oil Filter.....	H-5618	Hydraulic Oil Filter Transmission...	H-65030
431 (GRADERS)		540 (LOADERS) SA6D110-1		830C (GRADERS) D359T	
Hydraulic Oil Filter.....	H-5406	Hydraulic Oil Filter.....	H-5618	Hydraulic Oil Filter.....	HC-76080
440 (GRADERS) CUMMINS		550 (GRADERS) CUMMINS		830B (GRADERS) D359T	
Hydraulic Oil Filter Transmission...	H-65030	Hydraulic Oil Filter Transmission...	H-65030	Hydraulic Oil Filter.....	HC-76080
440H (GRADERS) CUMMINS		550 (LOADERS)		850B (GRADERS) D505T	
Hydraulic Oil Filter Transmission...	H-65030	Hydraulic Oil Filter.....	H-5403	Hydraulic Oil Filter.....	HC-76080
442 (GRADERS)		570 (LOADERS)		850C (GRADERS) D505T	
Hydraulic Oil Filter.....	H-5406	Hydraulic Oil Filter.....	H-5403	Hydraulic Oil Filter.....	HC-76080
460 (LOADERS)		60-1 (EXCAVATORS) 4D94-2D		870B (GRADERS) D505T	
Hydraulic Oil Filter.....	H-5405	Hydraulic Oil Filter.....	H-5607	Hydraulic Oil Filter.....	HC-76080
495 (GRADERS) DT817		606 (LOADERS)		870C (GRADERS) D505T	
Hydraulic Oil Filter Transmission...	H-65030	Hydraulic Oil Filter.....	H-5405	Hydraulic Oil Filter.....	HC-76080
504 (LOADERS)		60L (EXCAVATORS) 4D94-2D		B100 (LOADERS)	
Hydraulic Oil Filter.....	H-5405	Hydraulic Oil Filter.....	H-5607	Hydraulic Oil Filter.....	H-55270
505 (LOADERS) 4D92		60L-1 (EXCAVATORS) 4D94-2D		Hydraulic Oil Filter.....	H-5504
Hydraulic Oil Filter.....	H-5618	Hydraulic Oil Filter.....	H-5607	B175 (LOADERS)	
510 (LOADERS) 4D92		60L-2 (EXCAVATORS) 4D94-2D		Hydraulic Oil Filter.....	H-5405
Hydraulic Oil Filter.....	H-5618	Hydraulic Oil Filter.....	H-5607	B175B (LOADERS)	
510B (LOADERS) D240T		60N-1 (EXCAVATORS) 4D94-2		Hydraulic Oil Filter.....	H-5405
Hydraulic Oil Filter.....	H-5403	Hydraulic Oil Filter.....	H-5607	B414 (LOADERS)	
510C (LOADERS) D240T		60U-1 (EXCAVATORS) 4D94-2D		Hydraulic Oil Filter.....	H-5405
Hydraulic Oil Filter.....	H-5403	Hydraulic Oil Filter.....	H-5607	BF480RG-1 (CRUSHER) SAA6D125E-2	
515B (LOADERS)		60U-2 (EXCAVATORS) 4D94-2D		Hydraulic Oil Filter.....	H-2709
Hydraulic Oil Filter.....	H-5406				



ENGINE APPLICATION

MODEL/APPLICATION	SAKURA NO	MODEL/APPLICATION	SAKURA NO	MODEL/APPLICATION	SAKURA NO
KOMATSU		KOMATSU		KOMATSU	
BR200J-1 (CRUSHER) S6D95L		D120 (CONSTRUCTION EQUIPMENTS) DT817		D155AX-6 (EXCAVATORS)	
Hydraulic Oil Filter.....	H-7911	Hydraulic Oil Filter Transmission...	H-65030	Hydraulic Oil Filter.....	H-5629
BR200R-1 (CRUSHER) S6D95L		D120 (CONSTRUCTION EQUIPMENTS) DT817B		Hydraulic Oil Filter.....	H-56600
Hydraulic Oil Filter.....	H-7911	Hydraulic Oil Filter Transmission...	H-65030	D155AX-6SL (DOZERS) SAA6D140E-5	
BR200S-1 (CRUSHER) S6D95L		D120 SERIES B (CONSTRUCTION EQUIPMENTS) DT817		Hydraulic Oil Filter.....	H-56600
Hydraulic Oil Filter.....	H-7911	Hydraulic Oil Filter Transmission...	H-65030	D155C-1 (DOZERS) S6D155-4/15686	
BR300J-1 (CONSTRUCTION EQUIPMENTS) S/N: 1001		D120 SERIES C (CONSTRUCTION EQUIPMENTS) DT817		Hydraulic Oil Filter.....	H-5601
Hydraulic Oil Filter.....	H-7911	Hydraulic Oil Filter Transmission...	H-65030	Hydraulic Oil Filter.....	H-5606
BR310JG-1 (CRUSHER) SA6D95L		D135A-1 (DOZERS) SA6D125-1/10001		Hydraulic Oil Filter.....	H-5608
Hydraulic Oil Filter.....	H-7911	Hydraulic Oil Filter.....	H-5606	Hydraulic Oil Filter.....	H-5606
BR380JG-1E0 (CRUSHER) SAA6D107E-1 , 2011		Hydraulic Oil Filter.....	H-5610	Hydraulic Oil Filter.....	H-5606
Hydraulic Oil Filter.....	H-5629	Hydraulic Oil Filter.....	H-56600	Hydraulic Oil Filter.....	H-5606
BR500JG-1 (CRUSHER) SA6D125E-2		D135A-2 (DOZERS) S6D140-1/10301		Hydraulic Oil Filter.....	H-5606
Hydraulic Oil Filter.....	H-2709	Hydraulic Oil Filter.....	H-56600	Hydraulic Oil Filter.....	H-5606
BR500JG-1A (CRUSHER) SA6D125E-2		Hydraulic Oil Filter.....	H-5610	D155A-3 (DOZERS) S6D140-1/60001	
Hydraulic Oil Filter.....	H-2709	D150A-1 (DOZERS) S6D155		Hydraulic Oil Filter.....	H-5610
BR550JG-1 (CRUSHER) SAA6D125E-2		Hydraulic Oil Filter.....	H-5606	Hydraulic Oil Filter.....	H-56600
Hydraulic Oil Filter.....	H-2709	Hydraulic Oil Filter.....	H-56600	D155EX (DOZERS)	
CD110R-2 (CRAWLERS) SAA6D114E-2		D150A-1 (DOZERS) S6D155		Hydraulic Oil Filter.....	H-56600
Hydraulic Oil Filter.....	H-5618	Hydraulic Oil Filter.....	H-5606	D155A-6 (DOZERS) KOMATSU SAA6D140E-5GR-W	
D100 (CONSTRUCTION EQUIPMENTS) IHC		Hydraulic Oil Filter.....	H-5610	Hydraulic Oil Filter additional part..	H-7105
Hydraulic Oil Filter Transmission...	H-65030	Hydraulic Oil Filter.....	H-56600	D20 (DOZERS) 4D94/45001	
D100 (CONSTRUCTION EQUIPMENTS) NH220		D155A-2 (DOZERS) S6D155-4/50001		Hydraulic Oil Filter.....	HC-5602
Hydraulic Oil Filter Transmission...	H-65030	Hydraulic Oil Filter.....	H-56600	D20 (DOZERS) 4D95S/75001	
D100 (CONSTRUCTION EQUIPMENTS) NT-855		Hydraulic Oil Filter.....	H-5610	Hydraulic Oil Filter.....	HC-5602
Hydraulic Oil Filter Transmission...	H-65030	Hydraulic Oil Filter.....	H-56600	D20-7 (DOZERS) 4D95S	
D100 SERIES B (CONSTRUCTION EQUIPMENTS) IHC		Hydraulic Oil Filter Tank Breather..	H-56610	Hydraulic Oil Filter.....	HC-5602
Hydraulic Oil Filter Transmission...	H-65030	D155AX-5 (DOZERS) S/N: 70001		D20A-2 (DOZERS) C221	
D-1100 (GRADERS) CUMMINS		Hydraulic Oil Filter.....	H-56600	Hydraulic Oil Filter.....	H-5611
Hydraulic Oil Filter Transmission...	H-65030	D155AX-6 (DOZERS) KOMATSU SAA6D140E-5G-02		D20A-3 (DOZERS) 4D130-1	
D12 (DOZERS) CUMMINS		Hydraulic Oil Filter additional part..	H-7105	Hydraulic Oil Filter.....	H-5611
Hydraulic Oil Filter.....	H-5504	D155AX-6 (DOZERS) SAA6D140E-5		D20P (DOZERS) 4D130-1	
Hydraulic Oil Filter.....	H-5610	Hydraulic Oil Filter.....	H-5629	Hydraulic Oil Filter.....	H-5611
Hydraulic Oil Filter.....	H-55270	Hydraulic Oil Filter.....	H-56600	D20P-2 (DOZERS) C221	
Hydraulic Oil Filter.....	H-56600				



ENGINE APPLICATION

MODEL/APPLICATION	SAKURA NO	MODEL/APPLICATION	SAKURA NO	MODEL/APPLICATION	SAKURA NO
KOMATSU		KOMATSU		KOMATSU	
D20P-2 (DOZERS) C221 Hydraulic Oil Filter.....	H-5611	Hydraulic Oil Filter.....	HC-5602	Hydraulic Oil Filter.....	H-56600
D20P-3 (DOZERS) 4D130-1 Hydraulic Oil Filter.....	H-5611	D21P-6B (DOZERS) 4D95S-W Hydraulic Oil Filter.....	HC-5602	D275A (DUMP TRUCKS) Hydraulic Oil Filter.....	H-5629
D20Q-3 (DOZERS) 4D130-1 Hydraulic Oil Filter.....	H-5611	D21PL-5 (DOZERS) 4D94/45001 Hydraulic Oil Filter.....	HC-5602	D30A (DOZERS) 4D105 Hydraulic Oil Filter.....	H-5608
D20S (DOZERS) 4D130-1 Hydraulic Oil Filter.....	H-5611	D21PL-6 (DOZERS) 4D95S-W/60001 Hydraulic Oil Filter.....	HC-5602	D30A-15 (DOZERS) 4D92 Hydraulic Oil Filter.....	H-5608
D20S-2 (DOZERS) C221 Hydraulic Oil Filter.....	H-5611	D21PLL-5 (DOZERS) 4D94/45001 Hydraulic Oil Filter.....	HC-5602	D30P (DOZERS) 4D105 Hydraulic Oil Filter.....	H-5608
D20S-3 (DOZERS) 4D130-1 Hydraulic Oil Filter.....	H-5611	D21PLL-6 (DOZERS) 4D95S-W/60001 Hydraulic Oil Filter.....	HC-5602	D30P-15 (DOZERS) 4D92 Hydraulic Oil Filter.....	H-5608
D21 (DOZERS) FH-37 Hydraulic Oil Filter.....	H-5608	D21Q-3 (DOZERS) 4D130-1 Hydraulic Oil Filter.....	H-5611	D30Q-15 (DOZERS) 4D105 Hydraulic Oil Filter.....	H-5608
Hydraulic Oil Filter.....	H-5611	D21Q-5 (DOZERS) 4D94/45001 Hydraulic Oil Filter.....	HC-5602	D30Q-15 (DOZERS) 4D92 Hydraulic Oil Filter.....	H-5608
D21-7 (DOZERS) 4D95S/75001 Hydraulic Oil Filter.....	HC-5602	D21Q-6 (DOZERS) 4D95S-W/60001 Hydraulic Oil Filter.....	HC-5602	D30S (DOZERS) 4D105 Hydraulic Oil Filter.....	H-5608
D21A (DOZERS) 4D130-1 Hydraulic Oil Filter.....	H-5611	D21S (DOZERS) 4D130-1 Hydraulic Oil Filter.....	H-5611	D30S-15 (DOZERS) 4D92 Hydraulic Oil Filter.....	H-5608
D21A-3 (DOZERS) 4D130-1 Hydraulic Oil Filter.....	H-5611	D21S-3 (DOZERS) 4D130-1 Hydraulic Oil Filter.....	H-5611	D31 (DOZERS) FH-63 Hydraulic Oil Filter.....	H-5611
D21A-5 (DOZERS) 4D94/45001 Hydraulic Oil Filter.....	HC-5602	D21S-5 (DOZERS) 4D94/45001 Hydraulic Oil Filter.....	HC-5602	D31-17 (DOZERS) S/N: 32001 Hydraulic Oil Filter.....	HC-5601
D21A-6 (DOZERS) 4D95S-W/60001 Hydraulic Oil Filter.....	HC-5602	D21S-5 (DOZERS) FH-35 Hydraulic Oil Filter.....	H-5608	D31-18 (DOZERS) S/N: 40001 Hydraulic Oil Filter.....	HC-5602
D21E-6 (DOZERS) 4D95S-W/60001 Hydraulic Oil Filter.....	HC-5602	D21S-6 (DOZERS) 4D95S-W/60001 Hydraulic Oil Filter.....	HC-5602	D31-20 (DOZERS) S4D102E-1/42723 Hydraulic Oil Filter.....	HC-5602
D21P (DOZERS) 4D130-1 Hydraulic Oil Filter.....	H-5611	D275A-2 (DOZERS) S6D170-1/10001 Hydraulic Oil Filter.....	H-56600	D31A (DOZERS) 4D105 Hydraulic Oil Filter.....	H-5608
D21P-3 (DOZERS) 4D130-1 Hydraulic Oil Filter.....	H-5611	Hydraulic Oil Filter.....	H-5610	D31A (DOZERS) 4D105-1 Hydraulic Oil Filter.....	HC-5601
D21P-5 (DOZERS) 4D94/45001 Hydraulic Oil Filter.....	HC-5602	D275A-2D (DOZERS) S6D170-1 Hydraulic Oil Filter.....	H-5610	D31A (DOZERS) 4D92 Hydraulic Oil Filter.....	HC-5601
D21P-6 (DOZERS) 4D95S-W/60001 Hydraulic Oil Filter.....		Hydraulic Oil Filter.....	H-56600	D31A-15 (DOZERS) 4D92 Hydraulic Oil Filter.....	
		D275AX-5E0 (DOZERS) SAA6D140E-5 Hydraulic Oil Filter.....	H-5629		



ENGINE APPLICATION

MODEL/APPLICATION	SAKURA NO	MODEL/APPLICATION	SAKURA NO	MODEL/APPLICATION	SAKURA NO
KOMATSU		KOMATSU		KOMATSU	
D31A-15 (DOZERS) 4D92		D31Q-15 (DOZERS) 4D105		Hydraulic Oil Filter.....	H-5609
Hydraulic Oil Filter.....	H-5608	Hydraulic Oil Filter.....	H-5608	D355A-3 (DOZERS)	
D31A-16 (DOZERS) 4D105-1		D31Q-15 (DOZERS) 4D92		Hydraulic Oil Filter.....	H-5609
Hydraulic Oil Filter.....	HC-5601	Hydraulic Oil Filter.....	H-5608	Hydraulic Oil Filter.....	H-5606
D31A-16 (DOZERS) 4D92		D31Q-16 (DOZERS) 4D105-1		D355A-3 (DOZERS) SA6D155/1632	
Hydraulic Oil Filter.....	HC-5601	Hydraulic Oil Filter.....	HC-5601	Hydraulic Oil Filter.....	H-5606
D31A-17 (DOZERS) 4D105/32001		D31Q-16 (DOZERS) 4D92		Hydraulic Oil Filter.....	H-5609
Hydraulic Oil Filter.....	HC-5602	Hydraulic Oil Filter.....	HC-5601	Hydraulic Oil Filter.....	H-5609
D31E-18 (DOZERS) 6D95L-1/40001		D31Q-17 (DOZERS) 4D105/32001		D355C-3 (DOZERS) S6D155-4/3259	
Hydraulic Oil Filter.....	HC-5602	Hydraulic Oil Filter.....	HC-5602	Hydraulic Oil Filter.....	H-5606
D31P (DOZERS) 4D105		D31Q-18 (DOZERS) 6D95L-1/40001		Hydraulic Oil Filter.....	H-5601
Hydraulic Oil Filter.....	H-5608	Hydraulic Oil Filter.....	HC-5602	Hydraulic Oil Filter.....	H-5608
D31P (DOZERS) 4D105-1		D31S (DOZERS) 4D105		D37-2 (DOZERS) S/N: 1501	
Hydraulic Oil Filter.....	HC-5601	Hydraulic Oil Filter.....	H-5608	Hydraulic Oil Filter.....	HC-5602
D31P (DOZERS) 4D92		D31S (DOZERS) 4D105-1		D37-5 (DOZERS) S4D102E-1/3731	
Hydraulic Oil Filter.....	HC-5601	Hydraulic Oil Filter.....	HC-5601	Hydraulic Oil Filter.....	HC-5602
D31P-15 (DOZERS) 4D92		D31S (DOZERS) 4D92		D375A (DOZERS) SA6D170E-2A/17001/17353	
Hydraulic Oil Filter.....	H-5608	Hydraulic Oil Filter.....	HC-5601	Hydraulic Oil Filter.....	H-5609
D31P-16 (DOZERS) 4D105-1		D31S-15 (DOZERS) 4D92		D375A-1 (DOZERS) SA6D170E-2/15001	
Hydraulic Oil Filter.....	HC-5601	Hydraulic Oil Filter.....	H-5608	Hydraulic Oil Filter.....	H-5609
D31P-16 (DOZERS) 4D92		D31S-16 (DOZERS) 4D105-1		D375A-2 (DOZERS) SA6D170-1/16001	
Hydraulic Oil Filter.....	HC-5601	Hydraulic Oil Filter.....	HC-5601	Hydraulic Oil Filter.....	H-5609
D31P-17 (DOZERS) 4D105/32001		D31S-16 (DOZERS) 4D92		D375A-2 (DOZERS) SA6D170E-2/16001	
Hydraulic Oil Filter.....	HC-5602	Hydraulic Oil Filter.....	HC-5601	Hydraulic Oil Filter.....	H-5609
D31P-18 (DOZERS) 6D95L-1/40001		D31S-17 (DOZERS) 4D105/32001		D375A-3 (DOZERS) SA6D170-1/17001	
Hydraulic Oil Filter.....	HC-5602	Hydraulic Oil Filter.....	HC-5602	Hydraulic Oil Filter.....	H-5609
D31P-20A (DOZERS)		D32E-1 (DOZERS) 4D102E		D375A-3 (DOZERS) SA6D170E-2/17001	
Hydraulic Oil Filter.....	HC-5602	Hydraulic Oil Filter.....	HC-76080	Hydraulic Oil Filter.....	H-5609
D31PL-17 (DOZERS) 4D105/32001		D32P-1 (DOZERS) 4D102E		D375A-5 (DOZERS) SA6D170E	
Hydraulic Oil Filter.....	HC-5602	Hydraulic Oil Filter.....	HC-76080	Hydraulic Oil Filter.....	H-5609
D31PL-18 (DOZERS) 6D95L-1/40001		D355 (BACKHOES)		D375A-5 (DOZERS) SA6D170E-3	
Hydraulic Oil Filter.....	HC-5602	Hydraulic Oil Filter.....	H-5606	Hydraulic Oil Filter.....	H-5609
D31PLL-17 (DOZERS) 4D105/32001		D355A-1 (DOZERS) S6D155		D375A-5SL (DOZERS) SA6D170E	
Hydraulic Oil Filter.....	HC-5602	Hydraulic Oil Filter.....	H-5606	Hydraulic Oil Filter.....	H-5609



ENGINE APPLICATION

MODEL/APPLICATION	SAKURA NO	MODEL/APPLICATION	SAKURA NO	MODEL/APPLICATION	SAKURA NO
KOMATSU		KOMATSU		KOMATSU	
D37E-1 (DOZERS) 4D105/10001 Hydraulic Oil Filter.....	HC-5602	Hydraulic Oil Filter.....	H-5611	D41P-3 (DOZERS) 6D105-1 Hydraulic Oil Filter.....	H-5607
D37E-2 (DOZERS) 6D95L-1/1501 Hydraulic Oil Filter.....	HC-5602	D40A-3 (DOZERS) 6D105 Hydraulic Oil Filter.....	H-5607	D41P-6 (DOZERS) 6D102-1/B20001 Hydraulic Oil Filter.....	HC-5602
D37P-1 (DOZERS) 4D105/10001 Hydraulic Oil Filter.....	HC-5602	D40P (DOZERS) S4D105-3 Hydraulic Oil Filter.....	H-5608	D41Q-3 (DOZERS) 6D105-1 Hydraulic Oil Filter.....	H-5607
D37P-2 (DOZERS) 6D95L-1/1501 Hydraulic Oil Filter.....	HC-5602	Hydraulic Oil Filter.....	H-5611	D41S-3 (DOZERS) 6D105-1 Hydraulic Oil Filter.....	H-5607
D37A-5 (DOZERS) 6D95L-1AD , 2012 Hydraulic Oil Filter.....	HC-5602	D40P-1 (DOZERS) S4D105/1501 Hydraulic Oil Filter.....	H-5611	D445A-1 (DOZERS) VTA-1710 Hydraulic Oil Filter.....	H-5609
D38E-1 (DOZERS) S4D102E Hydraulic Oil Filter.....	HC-76080	Hydraulic Oil Filter.....	H-5608	Hydraulic Oil Filter.....	H-5622
D38E-1A (DOZERS) S4D102E Hydraulic Oil Filter.....	HC-76080	D40P-3 (DOZERS) 6D105 Hydraulic Oil Filter.....	H-5607	Hydraulic Oil Filter.....	H-5607
D38P-1A (DOZERS) S4D102E Hydraulic Oil Filter.....	HC-76080	D40PL-1 (DOZERS) S4D105/1501 Hydraulic Oil Filter.....	H-5611	D445A-1 (TRACTORS) w/Cummins VTA1710-1B Eng Hydraulic Oil Filter.....	H-5519
D39E-1 (DOZERS) S4D102E Hydraulic Oil Filter.....	HC-76080	Hydraulic Oil Filter.....	H-5608	D455A (TRACTORS) w/Cummins VTA1710-1B Eng Hydraulic Oil Filter.....	H-5519
D39E-1A (DOZERS) S4D102E Hydraulic Oil Filter.....	HC-76080	D40PL-1 (DOZERS) S4D105-3 Hydraulic Oil Filter.....	H-5608	D455A-1 (DOZERS) VTA-1710/1001 Hydraulic Oil Filter.....	H-5622
D39EX-21 (DOZERS) SAA4D102E Hydraulic Oil Filter.....	HC-5602	Hydraulic Oil Filter.....	H-5611	Hydraulic Oil Filter.....	H-5609
D39P-1 (DOZERS) S4D102E Hydraulic Oil Filter.....	HC-76080	D40PL-3 (DOZERS) 6D105 Hydraulic Oil Filter.....	H-5607	Hydraulic Oil Filter.....	H-5607
D39P-1A (DOZERS) S4D102E Hydraulic Oil Filter.....	HC-76080	D40PLL-1 (DOZERS) S4D105/1501 Hydraulic Oil Filter.....	H-5608	D455A-1 (TRACTORS) w/Cummins VTA1710-1B Eng Hydraulic Oil Filter.....	H-5519
D400 (CONSTRUCTION EQUIPMENTS) 12V-71 Hydraulic Oil Filter Transmission...	H-65030	Hydraulic Oil Filter.....	H-5611	D45A (DOZERS) S4D105-3 Hydraulic Oil Filter.....	H-5611
D400 (CONSTRUCTION EQUIPMENTS) VT-12-525 Hydraulic Oil Filter Transmission...	H-65030	D40PLL-3 (DOZERS) 6D105 Hydraulic Oil Filter.....	H-5607	Hydraulic Oil Filter.....	H-5608
D40-3 (DOZERS) 6001 Hydraulic Oil Filter.....	H-5607	D41-3 (DOZERS) S/N: 6001 Hydraulic Oil Filter.....	H-5607	D45A-1 (DOZERS) S4D105/1501 Hydraulic Oil Filter.....	H-5611
D40A (DOZERS) S4D105-3 Hydraulic Oil Filter.....	H-5608	D41A-3 (DOZERS) 6D105-1 Hydraulic Oil Filter.....	H-5607	D45E-1 (DOZERS) S4D105/1501 Hydraulic Oil Filter.....	H-5608
		D41-A6 (DOZERS) 6D102-1/B20001 Hydraulic Oil Filter.....	HC-5602	Hydraulic Oil Filter.....	H-5611
		D41E-6 (DOZERS) S6D102E-1/B20001 Hydraulic Oil Filter.....	HC-5602	D45P-1 (DOZERS) S4D105/1501 Hydraulic Oil Filter.....	H-5608
		D41-P (EXCAVATORS) Hydraulic Oil Filter.....	H-5607	Hydraulic Oil Filter.....	H-5608
				Hydraulic Oil Filter.....	H-5611



ENGINE APPLICATION

MODEL/APPLICATION	SAKURA NO	MODEL/APPLICATION	SAKURA NO	MODEL/APPLICATION	SAKURA NO
KOMATSU		KOMATSU		KOMATSU	
D45S-1 (DOZERS) S4D105/1501		D50A-15 (DOZERS) 4D105-5		Hydraulic Oil Filter.....	H-5526
Hydraulic Oil Filter.....	H-5607	Hydraulic Oil Filter.....	H-55280	Hydraulic Oil Filter.....	H-5608
Hydraulic Oil Filter.....	H-5611	Hydraulic Oil Filter.....	H-5608	Hydraulic Oil Filter.....	H-5503
D45S-1 (DOZERS) S4D105-3		Hydraulic Oil Filter.....	H-5503	Hydraulic Oil Filter.....	H-55280
Hydraulic Oil Filter.....	H-5611	Hydraulic Oil Filter.....	H-5526	D50S-16 (DOZERS) 4D130/65001	
Hydraulic Oil Filter.....	H-5607	D50A-15 (DOZERS) 4D120		Hydraulic Oil Filter.....	H-5611
D455 (TRACTORS) w/Cummins VTA1710-1B Eng		Hydraulic Oil Filter.....	H-55280	D51EX-22 (DOZERS) SAA6D107E-1 , 2008	
Hydraulic Oil Filter.....	H-5519	Hydraulic Oil Filter.....	H-5526	Hydraulic Oil Filter.....	HC-5602
D455-1 (TRACTORS) w/Cummins VTA1710-1B Eng		Hydraulic Oil Filter.....	H-5608	D51PX-22 (DOZERS) SAA6D107E-1 , 2008	
Hydraulic Oil Filter.....	H-5519	Hydraulic Oil Filter.....	H-5503	Hydraulic Oil Filter.....	HC-5602
D475 (EXCAVATORS) SA8V170		D50A-16 (DOZERS) 4D130/65001		D53A (DOZERS) 4D120	
Hydraulic Oil Filter.....	H-7911	Hydraulic Oil Filter.....	H-5608	Hydraulic Oil Filter.....	H-5608
D475A-1 (DOZERS) SA8V170-1/10001		D50A-17 (DOZERS) 6D125/80001		Hydraulic Oil Filter.....	H-5611
Hydraulic Oil Filter.....	H-7911	Hydraulic Oil Filter.....	H-5611	Hydraulic Oil Filter.....	H-5620
D475A-2 (DOZERS) SA12V140-1/10201		Hydraulic Oil Filter.....	H-5608	D53A (DOZERS) 4D130	
Hydraulic Oil Filter.....	H-7911	D50P-15 (DOZERS) 4D105-5		Hydraulic Oil Filter.....	H-5608
D475A-5 (CRAWLER DOZERS) 2007		Hydraulic Oil Filter.....	H-5608	Hydraulic Oil Filter.....	H-5611
Hydraulic Oil Filter.....	H-5639	Hydraulic Oil Filter.....	H-5526	Hydraulic Oil Filter.....	H-5620
D475A-5 (CRAWLER DOZERS) SDA12V140E		Hydraulic Oil Filter.....	H-55280	D53A (DOZERS) 6D125	
Hydraulic Oil Filter Tank Breather...	H-56610	Hydraulic Oil Filter.....	H-5503	Hydraulic Oil Filter.....	H-5608
Hydraulic Oil Filter.....	H-5609	D50P-15 (DOZERS) 4D120		Hydraulic Oil Filter.....	H-5620
D475A-5E0 (DOZERS) SAA12V140E-3		Hydraulic Oil Filter.....	H-5526	Hydraulic Oil Filter.....	H-5611
Hydraulic Oil Filter.....	H-5609	Hydraulic Oil Filter.....	H-5608	D53A-15 (DOZERS) S4D120	
D475ASD-5E0 (DOZERS) SAA12V140E-3		Hydraulic Oil Filter.....	H-55280	Hydraulic Oil Filter.....	H-5608
Hydraulic Oil Filter.....	H-5609	Hydraulic Oil Filter.....	H-5503	Hydraulic Oil Filter.....	H-5620
D500 (LOADERS) 16V-71		D50P-16 (DOZERS) 4D130/65001		D53A-16 (DOZERS) 4D120	
Hydraulic Oil Filter Transmission...	H-65030	Hydraulic Oil Filter.....	H-5608	Hydraulic Oil Filter.....	H-5620
D500 (LOADERS) VTA28-C		Hydraulic Oil Filter.....	H-5608	Hydraulic Oil Filter.....	H-5611
Hydraulic Oil Filter Transmission...	H-65030	D50PL-16 (DOZERS) 4D130/65001		D53A-16 (DOZERS) 4D130/65001	
D50-17 (DOZERS) 6D125/80001		Hydraulic Oil Filter.....	H-5608	Hydraulic Oil Filter.....	H-5608
Hydraulic Oil Filter.....	H-5608	Hydraulic Oil Filter.....	H-5611	Hydraulic Oil Filter.....	H-5620
Hydraulic Oil Filter.....	H-5611	D50PL-17 (DOZERS) 6D125/80001		D53A-17 (DOZERS) 6D125/80001	
D50A (DOZERS) 4D105-5		Hydraulic Oil Filter.....	H-5608	Hydraulic Oil Filter.....	H-5620
Hydraulic Oil Filter.....	H-5608	Hydraulic Oil Filter.....	H-5611	Hydraulic Oil Filter.....	H-5608
Hydraulic Oil Filter.....	H-55280	D50S-15 (DOZERS) 4D120		Hydraulic Oil Filter.....	H-5611
Hydraulic Oil Filter.....	H-5503	Hydraulic Oil Filter.....	H-5526	D53P-16 (DOZERS) 4D120	
Hydraulic Oil Filter.....	H-5526	Hydraulic Oil Filter.....	H-5608		
		Hydraulic Oil Filter.....	H-5608		
		Hydraulic Oil Filter.....	H-5503		
		Hydraulic Oil Filter.....	H-55280		
		D50S-15 (DOZERS) 4D120-11			



ENGINE APPLICATION

MODEL/APPLICATION	SAKURA NO	MODEL/APPLICATION	SAKURA NO	MODEL/APPLICATION	SAKURA NO
KOMATSU		KOMATSU		KOMATSU	
D53P-16 (DOZERS) 4D120		D555-2 (DOZERS)		D58-E (DOZERS)	
Hydraulic Oil Filter.....	H-5620	Hydraulic Oil Filter.....	H-5503	Hydraulic Oil Filter.....	H-5611
Hydraulic Oil Filter.....	H-5608	Hydraulic Oil Filter.....	H-5620	Hydraulic Oil Filter.....	H-5620
Hydraulic Oil Filter.....	H-5611	Hydraulic Oil Filter.....	H-55280	Hydraulic Oil Filter.....	H-5608
D53P-16 (DOZERS) 4D130		Hydraulic Oil Filter.....	H-5526	D58E-1 (DOZERS) 6D125/80588	
Hydraulic Oil Filter.....	H-5608	Hydraulic Oil Filter.....	H-5610	Hydraulic Oil Filter.....	H-5611
Hydraulic Oil Filter.....	H-5620	D555-3 (DOZERS) CUMMINS		Hydraulic Oil Filter.....	H-5620
Hydraulic Oil Filter.....	H-5611	Hydraulic Oil Filter.....	H-5503	Hydraulic Oil Filter.....	H-5608
D53P-16 (DOZERS) 4D130/65001		Hydraulic Oil Filter.....	H-5610	D58P-1 (DOZERS) 6D125/80588	
Hydraulic Oil Filter.....	H-5611	Hydraulic Oil Filter.....	H-55280	Hydraulic Oil Filter.....	H-5620
Hydraulic Oil Filter.....	H-5608	Hydraulic Oil Filter.....	H-56600	Hydraulic Oil Filter.....	H-5611
Hydraulic Oil Filter.....	H-5620	Hydraulic Oil Filter.....	H-5526	Hydraulic Oil Filter.....	H-5608
D53P-17 (DOZERS) 6D125/80001		D555-3 (DOZERS) S4D120		D60 (DOZERS) 6D125/45001	
Hydraulic Oil Filter.....	H-5620	Hydraulic Oil Filter.....	H-5620	Hydraulic Oil Filter.....	H-5620
Hydraulic Oil Filter.....	H-5611	Hydraulic Oil Filter.....	H-5610	Hydraulic Oil Filter.....	H-56600
Hydraulic Oil Filter.....	H-5608	Hydraulic Oil Filter.....	H-56600	Hydraulic Oil Filter.....	H-5610
D53S-15 (DOZERS) S4D120		D575A-2 (DOZERS) SA12V170-1/10001		D60 (DOZERS) NH220	
Hydraulic Oil Filter.....	H-5620	Hydraulic Oil Filter.....	H-7911	Hydraulic Oil Filter.....	H-5610
Hydraulic Oil Filter.....	H-5608	D575A-3 (DOZERS) SA12V170E-2		Hydraulic Oil Filter.....	H-5620
D53S-16 (DOZERS) 4D120		Hydraulic Oil Filter.....	H-5611	Hydraulic Oil Filter.....	H-56600
Hydraulic Oil Filter.....	H-5611	Hydraulic Oil Filter.....	H-7911	D60A (DOZERS)	
Hydraulic Oil Filter.....	H-5620	D575-1 (DOZERS) S4D130/6501 - 19999		Hydraulic Oil Filter.....	H-5601
Hydraulic Oil Filter.....	H-5610	Hydraulic Oil Filter.....	H-5620	Hydraulic Oil Filter.....	H-5620
Hydraulic Oil Filter.....	H-56600	Hydraulic Oil Filter.....	H-56600	D60A-6 (DOZERS) NH220-C1	
D53S-16 (DOZERS) 4D130		Hydraulic Oil Filter.....	H-5610	Hydraulic Oil Filter.....	H-5620
Hydraulic Oil Filter.....	H-56600	D575-1 (DOZERS) S4D130/29635		Hydraulic Oil Filter.....	H-5601
Hydraulic Oil Filter.....	H-5611	Hydraulic Oil Filter.....	H-5610	D60A-7 (DOZERS) NH220C1	
Hydraulic Oil Filter.....	H-5620	Hydraulic Oil Filter.....	H-5611	Hydraulic Oil Filter.....	H-5601
Hydraulic Oil Filter.....	H-5610	Hydraulic Oil Filter.....	H-5620	Hydraulic Oil Filter.....	H-5620
D53S-16 (DOZERS) 4D130/65001		D575-1 (DOZERS) S6D108/20001		D60A-8 (DOZERS) 6D125	
Hydraulic Oil Filter.....	H-5620	Hydraulic Oil Filter.....	H-56600	Hydraulic Oil Filter.....	H-5620
Hydraulic Oil Filter.....	H-5610	Hydraulic Oil Filter.....	H-5610	Hydraulic Oil Filter.....	H-5601
Hydraulic Oil Filter.....	H-56600	Hydraulic Oil Filter.....	H-5611	D60E-6 (DOZERS) NH220-C1	
D53S-17 (DOZERS) 4D130/80001		Hydraulic Oil Filter.....	H-5620	Hydraulic Oil Filter.....	H-5601
Hydraulic Oil Filter.....	H-5610	D575-1B (DOZERS) S6D108		Hydraulic Oil Filter.....	H-5620
Hydraulic Oil Filter.....	H-5620	Hydraulic Oil Filter.....	H-5610	D60E-7 (DOZERS) NH220C1	
Hydraulic Oil Filter.....	H-5611	Hydraulic Oil Filter.....	H-5611	Hydraulic Oil Filter.....	H-5601
Hydraulic Oil Filter.....	H-56600	Hydraulic Oil Filter.....	H-56600	Hydraulic Oil Filter.....	H-5620
D55S (DOZERS) CUMMINS		Hydraulic Oil Filter.....	H-5620	D60E-8 (DOZERS) 6D125	
Hydraulic Oil Filter.....	H-55280	D58-1 (DOZERS) 80588		Hydraulic Oil Filter.....	H-5620
Hydraulic Oil Filter.....	H-5526	Hydraulic Oil Filter.....	H-5611	Hydraulic Oil Filter.....	H-5601
Hydraulic Oil Filter.....	H-5503	Hydraulic Oil Filter.....	H-5608	Hydraulic Oil Filter.....	H-5620
		Hydraulic Oil Filter.....	H-5620		



ENGINE APPLICATION

MODEL/APPLICATION	SAKURA NO	MODEL/APPLICATION	SAKURA NO	MODEL/APPLICATION	SAKURA NO
KOMATSU		KOMATSU		KOMATSU	
D60F-7 (DOZERS) NTC-743/40001		D60S-3 (DOZERS) NH220		Hydraulic Oil Filter.....	H-5620
Hydraulic Oil Filter.....	H-5607	Hydraulic Oil Filter.....	H-56600	Hydraulic Oil Filter.....	H-56600
Hydraulic Oil Filter.....	H-5620	Hydraulic Oil Filter.....	H-5610	D65A-6 (DOZERS) NH220	
D60F-7 (DOZERS) NTO-6-CI/40001		D60S-6 (DOZERS) NH220		Hydraulic Oil Filter.....	H-56600
Hydraulic Oil Filter.....	H-5620	Hydraulic Oil Filter.....	H-56600	Hydraulic Oil Filter.....	H-5620
Hydraulic Oil Filter.....	H-5607	Hydraulic Oil Filter.....	H-5620	Hydraulic Oil Filter.....	H-5610
D60F-7A (DOZERS) NTC-743/40001		D60S-7 (DOZERS) NH220C1		D65A-6 (DOZERS) NH220-C1	
Hydraulic Oil Filter.....	H-5620	Hydraulic Oil Filter.....	H-5620	Hydraulic Oil Filter.....	H-5620
Hydraulic Oil Filter.....	H-5607	Hydraulic Oil Filter.....	H-5610	Hydraulic Oil Filter.....	H-5601
D60F-7A (DOZERS) NTO-6-CI/40001		D60S-8 (DOZERS) S/N: 45001		D65A-7 (DOZERS) NH220-C1/40001	
Hydraulic Oil Filter.....	H-5607	Hydraulic Oil Filter.....	H-5620	Hydraulic Oil Filter.....	H-5601
Hydraulic Oil Filter.....	H-5620	Hydraulic Oil Filter.....	H-5610	Hydraulic Oil Filter.....	H-5620
D60F-8 (DOZERS) 6D125		D60S-8 (DOZERS) S/N: 45001		D65A-8 (DOZERS) 6D125/45001	
Hydraulic Oil Filter.....	H-5601	Hydraulic Oil Filter.....	H-5620	Hydraulic Oil Filter.....	H-5601
Hydraulic Oil Filter.....	H-5620	Hydraulic Oil Filter.....	H-5610	Hydraulic Oil Filter.....	H-5620
D60P (DOZERS) NH220		D61EX-12 (DOZERS) S6D114E-1		D65E-12 (DOZERS) 6D125	
Hydraulic Oil Filter.....	H-5620	Hydraulic Oil Filter.....	H-5607	Hydraulic Oil Filter.....	H-5607
Hydraulic Oil Filter.....	H-56600	Hydraulic Oil Filter Return.....	HC-5603	Hydraulic Oil Filter.....	H-56600
Hydraulic Oil Filter.....	H-5610	D61EX-15E0 (DOZERS) SAA6D107E-1		Hydraulic Oil Filter.....	H-5610
D60P-3 (DOZERS) NH220		Hydraulic Oil Filter.....	H-5607	D65E-12 (DOZERS) 6D125/60001 - 60941	
Hydraulic Oil Filter.....	H-56600	D61PX-12 (DOZERS) S6D114E-1		Hydraulic Oil Filter.....	H-5610
Hydraulic Oil Filter.....	H-5610	Hydraulic Oil Filter Return.....	HC-5603	Hydraulic Oil Filter.....	H-5607
D60P-6 (DOZERS) NH220-C1		Hydraulic Oil Filter.....	H-5607	Hydraulic Oil Filter.....	H-56600
Hydraulic Oil Filter.....	H-5601	D61EX-15 (DOZERS) SAA6D107E-1 , 2005		D65E-12 (DOZERS) S6D125	
Hydraulic Oil Filter.....	H-5620	Hydraulic Oil Filter.....	H-5607	Hydraulic Oil Filter.....	H-5607
D60P-7 (DOZERS) NH220C1		D61PX-15 (DOZERS) SAA6D107E-1 , 2005		D65E-12 (DOZERS) S6D125/60001 - 60941	
Hydraulic Oil Filter.....	H-5601	Hydraulic Oil Filter.....	H-5607	Hydraulic Oil Filter.....	H-56600
Hydraulic Oil Filter.....	H-5620	D63E (DOZERS) 6D125E/1292		Hydraulic Oil Filter.....	H-5610
D60P-8 (DOZERS) 6D125		Hydraulic Oil Filter.....	H-5620	Hydraulic Oil Filter.....	H-5607
Hydraulic Oil Filter.....	H-5601	Hydraulic Oil Filter.....	H-5611	D65E-6 (DOZERS) NH220-C1	
Hydraulic Oil Filter.....	H-5620	Hydraulic Oil Filter.....	H-5608	Hydraulic Oil Filter.....	H-5601
D60PL-6 (DOZERS) NH220-C1		D63E-1 (DOZERS) 6D125/1001		Hydraulic Oil Filter.....	H-5620
Hydraulic Oil Filter.....	H-5601	Hydraulic Oil Filter.....	H-5620	D65E-7 (DOZERS) NH220-C1/40001	
Hydraulic Oil Filter.....	H-5620	Hydraulic Oil Filter.....	H-5611	Hydraulic Oil Filter.....	H-5620
D60PL-7 (DOZERS) NH220C1		Hydraulic Oil Filter.....	H-5608	Hydraulic Oil Filter.....	H-5601
Hydraulic Oil Filter.....	H-5620	D65A (DOZERS)		Hydraulic Oil Filter.....	H-5601
Hydraulic Oil Filter.....	H-5601	Hydraulic Oil Filter.....	H-5620	D65E-8 (DOZERS) 6D125/45001	
D60PL-8 (DOZERS) 6D125		Hydraulic Oil Filter.....	H-5601	Hydraulic Oil Filter.....	H-5601
Hydraulic Oil Filter.....	H-5620	D65A (DOZERS) NH220		Hydraulic Oil Filter.....	H-5620
Hydraulic Oil Filter.....	H-5601	Hydraulic Oil Filter.....	H-5610	D65EX-12 (DOZERS) 6D125/60001 - 60941	



ENGINE APPLICATION

MODEL/APPLICATION	SAKURA NO	MODEL/APPLICATION	SAKURA NO	MODEL/APPLICATION	SAKURA NO
KOMATSU		KOMATSU		KOMATSU	
D65EX-12 (DOZERS) 6D125/60001 - 60941		D65PL-6 (DOZERS) NH220		D65EX-16 (DOZERS) SAA6D114E-3 , 2010	
Hydraulic Oil Filter.....	H-5610	Hydraulic Oil Filter.....	H-56600	Hydraulic Oil Filter.....	H-56650
Hydraulic Oil Filter.....	H-5607	Hydraulic Oil Filter.....	H-5610		
Hydraulic Oil Filter.....	H-56600	Hydraulic Oil Filter.....	H-5620	D65PX-16 (DOZERS) SAA6D114E-3 , 2010	
				Hydraulic Oil Filter.....	H-56650
D65EX-12 (DOZERS) S6D125/60001 - 60941		D65PL-6 (DOZERS) NH220-C1		D65WX-16 (DOZERS) SAA6D114E-3 , 2011	
Hydraulic Oil Filter.....	H-56600	Hydraulic Oil Filter.....	H-5620	Hydraulic Oil Filter.....	H-56650
Hydraulic Oil Filter.....	H-5607	Hydraulic Oil Filter.....	H-5601		
Hydraulic Oil Filter.....	H-5610			D66S-1 (DOZERS) SAA6D110/1001	
D65EX-15 (DOZERS) SAA6D125E-3/67001/69000		D65PL-7 (DOZERS) NH220-C1/40001		Hydraulic Oil Filter.....	H-56600
Hydraulic Oil Filter.....	H-5607	Hydraulic Oil Filter.....	H-5601	Hydraulic Oil Filter.....	H-5611
		Hydraulic Oil Filter.....	H-5620	Hydraulic Oil Filter.....	H-5610
D65EX-15E0 (DOZERS) SAA6D114E-3/69001 , 2007		D65PL-8 (DOZERS) 6D125/45001		D68-1 (DOZERS) S/N: 45590	
Hydraulic Oil Filter Tank Breather...	H-56610	Hydraulic Oil Filter.....	H-5601	Hydraulic Oil Filter.....	H-5601
		Hydraulic Oil Filter.....	H-5620	Hydraulic Oil Filter.....	H-5620
D65F-8 (DOZERS) 6D125/45001		D65PX-12 (DOZERS) 6D125/60001 - 60941		D68E-1 (DOZERS) 6D125	
Hydraulic Oil Filter.....	H-5620	Hydraulic Oil Filter.....	H-56600	Hydraulic Oil Filter.....	H-5601
Hydraulic Oil Filter.....	H-5601	Hydraulic Oil Filter.....	H-5610	Hydraulic Oil Filter.....	H-5620
		Hydraulic Oil Filter.....	H-5607		
D65P (DOZERS) NH220		D65PX-12 (DOZERS) S6D125/60001 - 60941		D70-LE (DOZERS) 6D125/45200	
Hydraulic Oil Filter.....	H-5610	Hydraulic Oil Filter.....	H-5607	Hydraulic Oil Filter.....	H-5601
Hydraulic Oil Filter.....	H-5620	Hydraulic Oil Filter.....	H-56600	Hydraulic Oil Filter.....	H-5620
Hydraulic Oil Filter.....	H-56600	Hydraulic Oil Filter.....	H-5610		
D65P-12 (DOZERS) 6D125/60001 - 60941		D65PX-15E0 (DOZERS) SAA6D114E-3/69001 , 2007		D75A-1 (DOZERS) S6D125/10001	
Hydraulic Oil Filter.....	H-5607	Hydraulic Oil Filter Tank Breather...	H-56610	Hydraulic Oil Filter.....	H-5620
Hydraulic Oil Filter.....	H-5610			Hydraulic Oil Filter.....	H-5601
Hydraulic Oil Filter.....	H-56600				
D65P-12 (DOZERS) S6D125/60001 - 60941		D65S-6 (DOZERS) NH220		D75S-2 (DOZERS) NH220	
Hydraulic Oil Filter.....	H-5607	Hydraulic Oil Filter.....	H-5620	Hydraulic Oil Filter.....	H-5610
Hydraulic Oil Filter.....	H-5610	Hydraulic Oil Filter.....	H-56600	Hydraulic Oil Filter.....	H-56600
Hydraulic Oil Filter.....	H-56600	Hydraulic Oil Filter.....	H-5610		
D65P-6 (DOZERS) NH220		D65S-7 (DOZERS) NH220C1		D75S-3 (DOZERS) NT0-6-C1	
Hydraulic Oil Filter.....	H-5620	Hydraulic Oil Filter.....	H-5620	Hydraulic Oil Filter.....	H-56600
Hydraulic Oil Filter.....	H-5610	Hydraulic Oil Filter.....	H-56600	Hydraulic Oil Filter.....	H-5606
Hydraulic Oil Filter.....	H-56600	Hydraulic Oil Filter.....	H-5610	Hydraulic Oil Filter.....	H-5610
D65P-6 (DOZERS) NH220-C1		D65S-8 (DOZERS) 6D125/45001		D75S-5 (DOZERS) S6D125/15001	
Hydraulic Oil Filter.....	H-5601	Hydraulic Oil Filter.....	H-5620	Hydraulic Oil Filter.....	H-56600
Hydraulic Oil Filter.....	H-5620	Hydraulic Oil Filter.....	H-56600	Hydraulic Oil Filter.....	H-5606
		Hydraulic Oil Filter.....	H-5610	Hydraulic Oil Filter.....	H-5610
D65P-7 (DOZERS) NH220-C1/40001		D65WX-15E (DOZERS)		D80-12 (DOZERS) CUMMINS	
Hydraulic Oil Filter.....	H-5601	Hydraulic Oil Filter.....	H-5607	Hydraulic Oil Filter.....	H-5504
Hydraulic Oil Filter.....	H-5620			Hydraulic Oil Filter.....	H-56600
				Hydraulic Oil Filter.....	H-55270
D65P-8 (DOZERS) 6D125/45001		D65-16 (DOZERS) SAA6D114E-3 , 2010		Hydraulic Oil Filter.....	H-5610
Hydraulic Oil Filter.....	H-5620	Hydraulic Oil Filter.....	H-56650		
Hydraulic Oil Filter.....	H-5601			D80-18 (DOZERS) NT-855/25001	
				Hydraulic Oil Filter.....	H-56600



ENGINE APPLICATION

MODEL/APPLICATION	SAKURA NO	MODEL/APPLICATION	SAKURA NO	MODEL/APPLICATION	SAKURA NO
KOMATSU		KOMATSU		KOMATSU	
D80-18 (DOZERS) NT-855/25001		Hydraulic Oil Filter.....	H-5606	Hydraulic Oil Filter.....	H-5610
Hydraulic Oil Filter.....	H-5606	Hydraulic Oil Filter.....	H-5610	D85E-12 (DOZERS) NH220C1	
Hydraulic Oil Filter.....	H-5610	Hydraulic Oil Filter.....	H-56600	Hydraulic Oil Filter.....	H-5606
D80-8 (DOZERS) CUMMINS		D82E-18 (DOZERS) NT-855		Hydraulic Oil Filter.....	H-5607
Hydraulic Oil Filter.....	H-5504	Hydraulic Oil Filter.....	H-56600	D85E-18 (DOZERS) NT-855/25001	
Hydraulic Oil Filter.....	H-55270	Hydraulic Oil Filter.....	H-5606	Hydraulic Oil Filter.....	H-5606
Hydraulic Oil Filter.....	H-56600	Hydraulic Oil Filter.....	H-5610	Hydraulic Oil Filter.....	H-5610
Hydraulic Oil Filter.....	H-5610	D83-1 (DOZERS) S/N: 1001		Hydraulic Oil Filter.....	H-56600
D80A (DOZERS) NT-855		Hydraulic Oil Filter.....	H-5601	D85E-21 (DOZERS) S6D125/35001	
Hydraulic Oil Filter.....	H-5606	Hydraulic Oil Filter.....	H-5620	Hydraulic Oil Filter.....	H-5606
Hydraulic Oil Filter.....	H-5610	D83E-1 (DOZERS) S6D125-1/1001		Hydraulic Oil Filter.....	H-5610
Hydraulic Oil Filter.....	H-56600	Hydraulic Oil Filter.....	H-5620	Hydraulic Oil Filter.....	H-56600
D80A-12 (DOZERS) NH220		Hydraulic Oil Filter.....	H-5601	D85E-SS-2A (DOZERS) S6D125	
Hydraulic Oil Filter.....	H-5607	D83P-1 (DOZERS) S6D125-1/1001		Hydraulic Oil Filter.....	H-5607
Hydraulic Oil Filter.....	H-55270	Hydraulic Oil Filter.....	H-5620	Hydraulic Oil Filter.....	H-56600
Hydraulic Oil Filter.....	H-5504	Hydraulic Oil Filter.....	H-5601	Hydraulic Oil Filter.....	H-5610
D80A-12 (DOZERS) NH220-C1		D85-18 (DOZERS) NT-855/25001		D85EX-15 (DOZERS) SA6D125E , 2004-2007	
Hydraulic Oil Filter.....	H-5607	Hydraulic Oil Filter.....	H-56600	Hydraulic Oil Filter.....	H-5629
D80A-18 (DOZERS) NT-855		Hydraulic Oil Filter.....	H-5606	D85EX-15SL (DOZERS) SA6D125E , 2004	
Hydraulic Oil Filter.....	H-5606	Hydraulic Oil Filter.....	H-5610	Hydraulic Oil Filter.....	H-5629
Hydraulic Oil Filter.....	H-5610	Hydraulic Oil Filter.....	H-5610	D85P-12 (DOZERS) NH220-C1	
Hydraulic Oil Filter.....	H-56600	D85-21 (DOZERS) 35001		Hydraulic Oil Filter.....	H-5607
D80E (DOZERS) NT-855		Hydraulic Oil Filter.....	H-56600	D85P-18 (DOZERS) NT-855	
Hydraulic Oil Filter.....	H-56600	Hydraulic Oil Filter.....	H-5606	Hydraulic Oil Filter.....	H-5606
Hydraulic Oil Filter.....	H-5606	Hydraulic Oil Filter.....	H-5610	Hydraulic Oil Filter.....	H-5610
Hydraulic Oil Filter.....	H-5610	Hydraulic Oil Filter.....	H-5610	Hydraulic Oil Filter.....	H-56600
D80E-12 (DOZERS) NH220-C1		Hydraulic Oil Filter.....	H-56600	D85P-18 (DOZERS) NT-855/2001	
Hydraulic Oil Filter.....	H-5607	D85A-12 (DOZERS) NH220C1		Hydraulic Oil Filter.....	H-5606
D80E18 (DOZERS) NT-855		Hydraulic Oil Filter.....	H-5606	Hydraulic Oil Filter.....	H-5610
Hydraulic Oil Filter.....	H-5606	Hydraulic Oil Filter.....	H-5610	Hydraulic Oil Filter.....	H-56600
Hydraulic Oil Filter.....	H-5610	Hydraulic Oil Filter.....	H-5607	D85P-21 (DOZERS) S6D125	
Hydraulic Oil Filter.....	H-56600	D85A-18 (DOZERS) NT-855/25001		Hydraulic Oil Filter.....	H-5606
D80P (DOZERS) NT-855		Hydraulic Oil Filter.....	H-56600	Hydraulic Oil Filter.....	H-5610
Hydraulic Oil Filter.....	H-5606	Hydraulic Oil Filter.....	H-5606	Hydraulic Oil Filter.....	H-56600
Hydraulic Oil Filter.....	H-5610	Hydraulic Oil Filter.....	H-5610	D85P-21 (DOZERS) S6D125/3001	
Hydraulic Oil Filter.....	H-56600	D85A-21 (DOZERS) S6D125/35001		Hydraulic Oil Filter.....	H-56600
D80P-12 (DOZERS) NTO-6-C1		Hydraulic Oil Filter.....	H-5606	Hydraulic Oil Filter.....	H-5606
Hydraulic Oil Filter.....	H-5607	Hydraulic Oil Filter.....	H-5610	Hydraulic Oil Filter.....	H-5610
Hydraulic Oil Filter.....	H-55270	Hydraulic Oil Filter.....	H-56600	D85PX (DOZERS)	
Hydraulic Oil Filter.....	H-5504	D85E (DOZERS) NT-855		Hydraulic Oil Filter.....	H-5610
D82E (DOZERS) NT-855		Hydraulic Oil Filter.....	H-56600	Hydraulic Oil Filter.....	H-5629
Hydraulic Oil Filter.....	H-5606	Hydraulic Oil Filter.....	H-5606		



ENGINE APPLICATION

MODEL/APPLICATION	SAKURA NO	MODEL/APPLICATION	SAKURA NO	MODEL/APPLICATION	SAKURA NO
KOMATSU		KOMATSU		KOMATSU	
D85PX (DOZERS)		Hydraulic Oil Filter.....	H-5608	Hydraulic Oil Filter Full Flow.....	HC-7901
Hydraulic Oil Filter.....	H-56600	DHS030-1 (LOADERS)		FG45 (FORKLIFTS) P40	
D85PX-15 (DOZERS) SAGD125E , 2004-2007		Hydraulic Oil Filter.....	H-5608	Hydraulic Oil Filter Full Flow.....	HC-7901
Hydraulic Oil Filter.....	H-5629	E-270 (GRADERS) DVT-573		FG45-4 (FORKLIFTS) P40	
D85EX-15E0 (DOZERS) SAA6D125E-5		Hydraulic Oil Filter Transmission...	H-65030	Hydraulic Oil Filter Full Flow.....	HC-7901
Hydraulic Oil Filter.....	H-5629	FD33 (FORKLIFTS) 6D95L		FG45S (FORKLIFTS) P40	
D85EX-15R (DOZERS) SAGD125E , 2004-2007		Hydraulic Oil Filter Full Flow.....	HC-7901	Hydraulic Oil Filter Full Flow.....	HC-7901
Hydraulic Oil Filter.....	H-5629	FD35 (FORKLIFTS) 6D95L		GD200A-1 (GRADERS) 4D150-5/2001	
D90 SERIES C (LOADERS) DT573		Hydraulic Oil Filter Full Flow.....	HC-7901	Hydraulic Oil Filter.....	H-5611
Hydraulic Oil Filter Transmission...	H-65030	FD35N (FORKLIFTS) 6D95L		GD22-1 (GRADERS) 4D92	
D90 SERIES C (LOADERS) V6R-180		Hydraulic Oil Filter Full Flow.....	HC-7901	Hydraulic Oil Filter.....	H-5611
Hydraulic Oil Filter Transmission...	H-65030	FD40 (FORKLIFTS) 6D95L		GD22AC-1 (GRADERS) 4D105-1	
D95S-1 (DOZERS) S4D155		Hydraulic Oil Filter Full Flow.....	HC-7901	Hydraulic Oil Filter.....	H-5611
Hydraulic Oil Filter.....	H-5610	FD40Z (FORKLIFTS) 6D95L		GD28AC-1 (GRADERS) 4D105-1	
Hydraulic Oil Filter.....	H-5504	Hydraulic Oil Filter Full Flow.....	HC-7901	Hydraulic Oil Filter.....	H-5611
Hydraulic Oil Filter.....	H-55270	FD45 (FORKLIFTS) 6D95L		GD300A-1 (GRADERS) 4D150-5/2001	
Hydraulic Oil Filter.....	H-56600	Hydraulic Oil Filter Full Flow.....	HC-7901	Hydraulic Oil Filter.....	H-5611
D95S-2 (DOZERS) NT-855/2001		FD45H (FORKLIFTS) 6D95L		GD313A-1 (GRADERS) 6D95L-1/30001	
Hydraulic Oil Filter.....	H-5606	Hydraulic Oil Filter Full Flow.....	HC-7901	Hydraulic Oil Filter.....	H-5625
Hydraulic Oil Filter.....	H-5610	FD45S (FORKLIFTS) 6D95L		GD31-3H (GRADERS) S4D120	
Hydraulic Oil Filter.....	H-56600	Hydraulic Oil Filter Full Flow.....	HC-7901	Hydraulic Oil Filter.....	H-5608
DA85A-12 (DOZERS) NH220		FD70H (FORKLIFTS)		GD31RC-3A (GRADERS) 4D130	
Hydraulic Oil Filter.....	H-5607	Hydraulic Oil Filter Full Flow.....	HC-7901	Hydraulic Oil Filter.....	H-5608
Hydraulic Oil Filter.....	H-55270	FG25T-12 (FORKLIFTS) 37Z-02-0F201L		GD37-5H (GRADERS) S4D120	
Hydraulic Oil Filter.....	H-5504	Hydraulic Oil Filter Transmission...	HC-1119	Hydraulic Oil Filter.....	H-5608
DDC045 (DOZERS)		FG33 (FORKLIFTS) P40		GD37-6H (GRADERS) NH220	
Hydraulic Oil Filter.....	H-5608	Hydraulic Oil Filter Full Flow.....	HC-7901	Hydraulic Oil Filter.....	H-5608
DDC050 (DOZERS)		FG33N (FORKLIFTS) P40		GD40-2 (GRADERS) NH220	
Hydraulic Oil Filter.....	H-5608	Hydraulic Oil Filter Full Flow.....	HC-7901	Hydraulic Oil Filter.....	H-5611
DDC060 (DOZERS)		FG35 (FORKLIFTS) P40		GD405A-1 (GRADERS) 6D105-1/50002	
Hydraulic Oil Filter.....	H-5601	Hydraulic Oil Filter Full Flow.....	HC-7901	Hydraulic Oil Filter.....	H-5608
DDM045 (DOZERS)		FG40 (FORKLIFTS) P40		Hydraulic Oil Filter.....	H-5620
Hydraulic Oil Filter.....	H-5608	Hydraulic Oil Filter Full Flow.....	HC-7901	GD461A-1 (GRADERS) S6D95L-1/10001	
DDM060 (DOZERS)		FG40Z (FORKLIFTS) P40		Hydraulic Oil Filter.....	H-5625
Hydraulic Oil Filter.....	H-5601	Hydraulic Oil Filter Full Flow.....	HC-7901	Hydraulic Oil Filter.....	H-5620
Hydraulic Oil Filter.....	H-5608				



ENGINE APPLICATION

MODEL/APPLICATION	SAKURA NO	MODEL/APPLICATION	SAKURA NO	MODEL/APPLICATION	SAKURA NO
KOMATSU		KOMATSU		KOMATSU	
GD500R-1 (GRADERS) S4D130-1/10001		GD521A-1 (GRADERS) S6D105-1/10001		GD555-3C (GRADERS) SA6D102E	
Hydraulic Oil Filter.....	H-5608	Hydraulic Oil Filter.....	H-5607	Hydraulic Oil Filter.....	H-56600
GD500R-1 (GRADERS) SYD130-1		GD521R-1 (GRADERS) S6D105-1/10001		GD555-3C (GRADERS) SAA6D102E	
Hydraulic Oil Filter.....	H-5608	Hydraulic Oil Filter.....	H-5607	Hydraulic Oil Filter.....	H-56600
GD500R-2 (GRADERS) NH220		GD523A-1 (GRADERS)		GD600R (GRADERS)	
Hydraulic Oil Filter.....	H-5608	Hydraulic Oil Filter.....	H-5607	Hydraulic Oil Filter.....	H-5620
		Hydraulic Oil Filter.....	H-5620		
GD500R-2 (GRADERS) S6D105-1/11002		GD523A-1 (GRADERS) S6D105-1/30001		GD600R-1 (GRADERS) NH220/10002	
Hydraulic Oil Filter.....	H-5608	Hydraulic Oil Filter.....	H-5607	Hydraulic Oil Filter.....	H-5608
GD500R-5 (GRADERS) S/N: 11002		GD523R-1 (GRADERS) S6D105-1/30001		GD600R-2 (GRADERS) NH220/13001	
Hydraulic Oil Filter.....	H-5608	Hydraulic Oil Filter.....	H-5607	Hydraulic Oil Filter.....	H-5620
Hydraulic Oil Filter.....	H-5620	Hydraulic Oil Filter.....	H-5607		
GD505A-2 (GRADERS) S6D105-1/50002		GD525A-1 (GRADERS) S6D105-1/50001		GD600R-3 (GRADERS) 6D125-1/14001	
Hydraulic Oil Filter.....	H-5608	Hydraulic Oil Filter.....	H-5607	Hydraulic Oil Filter.....	H-5620
Hydraulic Oil Filter.....	H-5620				
GD505R-2 (GRADERS) S6D105-1		GD525A-1 (GRADERS) S/N: 50001		GD605 (GRADERS)	
Hydraulic Oil Filter.....	H-5608	Hydraulic Oil Filter.....	H-5607	Hydraulic Oil Filter.....	H-5620
Hydraulic Oil Filter.....	H-5620	Hydraulic Oil Filter.....	H-5620		
GD505R-2 (GRADERS) S6D105-1/30002		GD530 (GRADERS)		GD605A-1 (GRADERS) NH220	
Hydraulic Oil Filter.....	H-5608	Hydraulic Oil Filter.....	HC-76080	Hydraulic Oil Filter.....	H-5620
Hydraulic Oil Filter.....	H-5620				
GD510R-1 (GRADERS) S/N: 15001		GD530-2A (GRADERS)		GD605A-1 (GRADERS) NH220/50002	
Hydraulic Oil Filter.....	H-5607	Hydraulic Oil Filter.....	HC-76080	Hydraulic Oil Filter.....	H-5620
		Hydraulic Oil Filter.....	HC-5508		
GD510R-2 (GRADERS) S6D95L-1/15001		GD530-2B (GRADERS)		GD605A-2 (GRADERS) NH220/53001	
Hydraulic Oil Filter.....	H-5607	Hydraulic Oil Filter.....	HC-5508	Hydraulic Oil Filter.....	H-5620
		Hydraulic Oil Filter.....	HC-76080		
GD511A-1 (GRADERS) S6D95L-1/10001		GD530-2C (GRADERS)		GD605A-3 (GRADERS) 6D125-1/54001	
Hydraulic Oil Filter.....	H-5607	Hydraulic Oil Filter.....	HC-76080	Hydraulic Oil Filter.....	H-5620
		Hydraulic Oil Filter.....	HC-5508		
GD511R-1 (GRADERS) S6D95L-1/10001		GD530A-1 (GRADERS) CUMMINS DIESEL		GD605R-1 (GRADERS) NH220/30002	
Hydraulic Oil Filter.....	H-5607	Hydraulic Oil Filter.....	HC-76080	Hydraulic Oil Filter.....	H-5608
		Hydraulic Oil Filter.....	HC-5508	Hydraulic Oil Filter.....	H-5620
GD513A-1 (GRADERS)		GD530A-2 (GRADERS) CUMMINS DIESEL		GD605R-2 (GRADERS) NH220/33001	
Hydraulic Oil Filter.....	H-5620	Hydraulic Oil Filter.....	HC-76080	Hydraulic Oil Filter.....	H-5620
Hydraulic Oil Filter.....	H-5607	Hydraulic Oil Filter.....	HC-5508		
		Hydraulic Oil Filter.....	HC-76080		
GD515A-1 (GRADERS)		GD555-3 (GRADERS) SA6D102E		GD611A-1 (GRADERS) S6D105-1/10001	
Hydraulic Oil Filter.....	H-5620	Hydraulic Oil Filter.....	H-56600	Hydraulic Oil Filter.....	H-5607
Hydraulic Oil Filter.....	H-5607				
GD521A-1 (GRADERS)		GD555-3 (GRADERS) SAA6D102E		GD613A-1 (GRADERS) 6D125-1/30001	
Hydraulic Oil Filter.....	H-5620	Hydraulic Oil Filter.....	H-56600	Hydraulic Oil Filter.....	H-5607
Hydraulic Oil Filter.....	H-5607				



ENGINE APPLICATION

MODEL/APPLICATION	SAKURA NO	MODEL/APPLICATION	SAKURA NO	MODEL/APPLICATION	SAKURA NO
KOMATSU		KOMATSU		KOMATSU	
GD613R-1 (GRADERS) S6D105-1/30001		GD650R-1 (GRADERS) NH220/21001		GD670-2A (GRADERS)	
Hydraulic Oil Filter.....	H-5607	Hydraulic Oil Filter.....	H-5608	Hydraulic Oil Filter.....	HC-76080
GD615A-1 (GRADERS) S6D110-1		GD650R-2 (GRADERS) NH220/23001		Hydraulic Oil Filter.....	HC-5508
Hydraulic Oil Filter.....	H-5607	Hydraulic Oil Filter.....	H-5620	GD670A-2 (GRADERS) CUMMINS DIESEL	
Hydraulic Oil Filter.....	H-5620	GD650R-3 (GRADERS) 6D125-1/24001		Hydraulic Oil Filter.....	HC-76080
GD621A-1 (GRADERS) S6D105-1/10001		Hydraulic Oil Filter.....	H-5620	Hydraulic Oil Filter.....	HC-5508
Hydraulic Oil Filter.....	H-5607	GD655-3 (GRADERS) S6D114E		GD670A-2C (GRADERS) S6D114E/202727	
GD621R-1 (GRADERS) S6D105-1/10001		Hydraulic Oil Filter.....	H-5620	Hydraulic Oil Filter.....	HC-76080
Hydraulic Oil Filter.....	H-5607	GD655-3A (GRADERS) 2008		Hydraulic Oil Filter.....	HC-5508
GD623R-1 (GRADERS) S6D105-1/30001		Hydraulic Oil Filter.....	H-56600	Hydraulic Oil Filter.....	HC-76080
Hydraulic Oil Filter.....	H-5607	GD655-3E0 (GRADERS) SAA6D114E-3		GD670AW-2B (GRADERS) S6D114E/202487	
GD625A-1 (GRADERS) 6D125-1/50001		Hydraulic Oil Filter.....	H-56600	Hydraulic Oil Filter.....	HC-5508
Hydraulic Oil Filter.....	H-5620	GD655A-1 (GRADERS) NH220		Hydraulic Oil Filter.....	HC-76080
Hydraulic Oil Filter.....	H-5607	Hydraulic Oil Filter.....	H-5620	GD670AW-2C (GRADERS) S6D114E/202727	
GD650-1 (GRADERS) S6D114		GD655A-1 (GRADERS) NH220/60001		Hydraulic Oil Filter.....	HC-76080
Hydraulic Oil Filter.....	HC-76080	Hydraulic Oil Filter.....	H-5620	Hydraulic Oil Filter.....	HC-5508
Hydraulic Oil Filter.....	HC-5508	Hydraulic Oil Filter.....	H-5608	GD675-3 (GRADERS) SAA6D114E-3	
GD650-2A (GRADERS)		Hydraulic Oil Filter.....	H-5608	Hydraulic Oil Filter.....	H-56600
Hydraulic Oil Filter.....	HC-76080	GD655A-2 (GRADERS) NH220/63001		GD675-3E0 (GRADERS) SAA6D114E-3	
Hydraulic Oil Filter.....	HC-5508	Hydraulic Oil Filter.....	H-5620	Hydraulic Oil Filter.....	H-56600
GD650-2B (GRADERS)		GD655A-3 (GRADERS) 6D125-1/64001		GD655-5 (GRADERS) SAA6D107E , 2010	
Hydraulic Oil Filter.....	HC-76080	Hydraulic Oil Filter.....	H-5620	Hydraulic Oil Filter.....	H-56600
Hydraulic Oil Filter.....	HC-5508	GD655R-1 (GRADERS) NH220/40001		GD705A-3 (GRADERS) NT0-6/10002	
GD650A-2 (GRADERS) S6D114		Hydraulic Oil Filter.....	H-5608	Hydraulic Oil Filter.....	H-5620
Hydraulic Oil Filter.....	HC-5508	Hydraulic Oil Filter.....	H-5620	GD705A-4 (GRADERS) S6D125-1/21001	
Hydraulic Oil Filter.....	HC-76080	GD655R-2 (GRADERS) NH220/43001		Hydraulic Oil Filter.....	H-5620
GD650A-2B (GRADERS) S6D114E/202487		Hydraulic Oil Filter.....	H-5620	GD705R-2 (GRADERS) NH220/1001	
Hydraulic Oil Filter.....	HC-5508	GD655R-3 (GRADERS) 6D125-1/44001		Hydraulic Oil Filter.....	H-5611
Hydraulic Oil Filter.....	HC-76080	Hydraulic Oil Filter.....	H-5620	GD705R-4 (GRADERS) 6D125-1/16001	
GD650A-2C (GRADERS) S6D114E/202727		GD661A-1 (GRADERS) S6D95L-1/10001		Hydraulic Oil Filter.....	H-5620
Hydraulic Oil Filter.....	HC-76080	Hydraulic Oil Filter.....	H-5607	GD725A-1 (GRADERS) S6D125-1/50001	
Hydraulic Oil Filter.....	HC-5508	GD663A-1 (GRADERS) 6D125-1/30001		Hydraulic Oil Filter.....	H-5610
GD650A-2E (GRADERS) S6D114E		Hydraulic Oil Filter.....	H-5607	Hydraulic Oil Filter.....	H-56600
Hydraulic Oil Filter.....	HC-76080	GD670-1 (GRADERS) CUMMINS DIESEL		GD750A-1 (GRADERS) S/N: 7003	
Hydraulic Oil Filter.....	HC-5508	Hydraulic Oil Filter.....	HC-5508	Hydraulic Oil Filter.....	HC-76080
Hydraulic Oil Filter.....	HC-5508	Hydraulic Oil Filter.....	HC-76080		



ENGINE APPLICATION

MODEL/APPLICATION	SAKURA NO	MODEL/APPLICATION	SAKURA NO	MODEL/APPLICATION	SAKURA NO
KOMATSU		KOMATSU		KOMATSU	
GD825A-2 (GRADERS) S6D140/12001		H30B (LOADERS)		Hydraulic Oil Filter Transmission...	H-65030
Hydraulic Oil Filter.....	H-5618	Hydraulic Oil Filter Transmission...	H-65030	H60 (CONSTRUCTION EQUIPMENTS) G-372	
GF505A (GRADERS)		Hydraulic Oil Filter Transmission...	H-65030	Hydraulic Oil Filter Transmission...	H-65030
Hydraulic Oil Filter.....	H-5620	H30F SERIES B (CONSTRUCTION EQUIPMENTS) 3-53		H60 (SHOVELS)	
GF615A-1 (GRADERS) S/N: 50001		Hydraulic Oil Filter Transmission...	H-65030	Hydraulic Oil Filter Transmission...	H-65030
Hydraulic Oil Filter.....	H-5620	H30F SERIES B (CONSTRUCTION EQUIPMENTS) G-263		H-60 SERIES B (CONSTRUCTION EQUIPMENTS) D301	
Hydraulic Oil Filter.....	H-5607	Hydraulic Oil Filter Transmission...	H-65030	Hydraulic Oil Filter.....	H-5640
GS360-1 (GRADERS)		H30F SERIES B (CONSTRUCTION EQUIPMENTS) UD-236		H-60 SERIES B (CONSTRUCTION EQUIPMENTS) V-352-C	
Hydraulic Oil Filter.....	H-5610	Hydraulic Oil Filter Transmission...	H-65030	Hydraulic Oil Filter.....	H-5640
Hydraulic Oil Filter.....	H-56600	H-30R SERIES B (CONSTRUCTION EQUIPMENTS) 3-53		H65 (EXCAVATORS)	
H100 (CONSTRUCTION EQUIPMENTS) IHC		Hydraulic Oil Filter Transmission...	H-65030	Hydraulic Oil Filter.....	HC-5502
Hydraulic Oil Filter Transmission...	H-65030	H-30R SERIES B (CONSTRUCTION EQUIPMENTS) U-236		H-65 (CONSTRUCTION EQUIPMENTS) G-372	
H100 (CONSTRUCTION EQUIPMENTS) NH220		Hydraulic Oil Filter Transmission...	H-65030	Hydraulic Oil Filter Transmission...	H-65030
Hydraulic Oil Filter Transmission...	H-65030	H-30R SERIES B (CONSTRUCTION EQUIPMENTS) U-240		H-65 SERIES B (CONSTRUCTION EQUIPMENTS) 3-71	
H100 (CONSTRUCTION EQUIPMENTS) NH250		Hydraulic Oil Filter Transmission...	H-65030	Hydraulic Oil Filter Transmission...	H-65030
Hydraulic Oil Filter Transmission...	H-65030	H-40 (CONSTRUCTION EQUIPMENTS) G-264		H65C (CONSTRUCTION EQUIPMENTS) DT414	
H100 (CONSTRUCTION EQUIPMENTS) NT-855		Hydraulic Oil Filter Transmission...	H-65030	Hydraulic Oil Filter.....	H-5640
Hydraulic Oil Filter Transmission...	H-65030	H-40 (CONSTRUCTION EQUIPMENTS) UD-282		H-70 SERIES B (CONSTRUCTION EQUIPMENTS) U-372	
H100 SERIES B (CONSTRUCTION EQUIPMENTS) IHC		Hydraulic Oil Filter Transmission...	H-65030	Hydraulic Oil Filter Transmission...	H-65030
Hydraulic Oil Filter Transmission...	H-65030	H400 (CONSTRUCTION EQUIPMENTS) 12V-71		H-70 SERIES C (CONSTRUCTION EQUIPMENTS) 4-71	
H100 SERIES C (CONSTRUCTION EQUIPMENTS) IHC		Hydraulic Oil Filter Transmission...	H-65030	Hydraulic Oil Filter Transmission...	H-65030
Hydraulic Oil Filter Transmission...	H-65030	H400 (CONSTRUCTION EQUIPMENTS) VT-12-525		H-70 SERIES C (CONSTRUCTION EQUIPMENTS) C-160	
H100B (SHOVELS) BD264		Hydraulic Oil Filter Transmission...	H-65030	Hydraulic Oil Filter Transmission...	H-65030
Hydraulic Oil Filter Transmission...	H-65030	H-50 SERIES B (CONSTRUCTION EQUIPMENTS) 3-53		H-70 SERIES F (CONSTRUCTION EQUIPMENTS) 4-71	
H120C (CONSTRUCTION EQUIPMENTS) DT817		Hydraulic Oil Filter Transmission...	H-65030	Hydraulic Oil Filter Transmission...	H-65030
Hydraulic Oil Filter Transmission...	H-65030	H-50 SERIES B (CONSTRUCTION EQUIPMENTS) G-301		H-70 SERIES F (CONSTRUCTION EQUIPMENTS) C-160	
H120C (CONSTRUCTION EQUIPMENTS) DT817B		Hydraulic Oil Filter Transmission...	H-65030	Hydraulic Oil Filter Transmission...	H-65030
Hydraulic Oil Filter Transmission...	H-65030	H-50 SERIES B (CONSTRUCTION EQUIPMENTS) UD-282		H-80 (CONSTRUCTION EQUIPMENTS) DT429	
H30 SERIES B (CONSTRUCTION EQUIPMENTS) 3-53		Hydraulic Oil Filter Transmission...	H-65030	Hydraulic Oil Filter.....	H-5640
Hydraulic Oil Filter Transmission...	H-65030	H-50 SERIES C (CONSTRUCTION EQUIPMENTS) D282		H80A (CONSTRUCTION EQUIPMENTS) DT429	
H30 SERIES B (CONSTRUCTION EQUIPMENTS) G-263		Hydraulic Oil Filter.....	H-5640	Hydraulic Oil Filter.....	H-5640
Hydraulic Oil Filter Transmission...	H-65030	H50B (SHOVELS)		H-90 (CONSTRUCTION EQUIPMENTS) 4-71	
H30 SERIES B (CONSTRUCTION EQUIPMENTS) UD-236		Hydraulic Oil Filter Transmission...	H-65030	Hydraulic Oil Filter Transmission...	H-65030
Hydraulic Oil Filter Transmission...	H-65030	H60 (CONSTRUCTION EQUIPMENTS) 3-71		H-90 (CONSTRUCTION EQUIPMENTS) WXLC-3	



ENGINE APPLICATION

MODEL/APPLICATION	SAKURA NO	MODEL/APPLICATION	SAKURA NO	MODEL/APPLICATION	SAKURA NO
KOMATSU		KOMATSU		KOMATSU	
H-90 (CONSTRUCTION EQUIPMENTS) WXL-3 Hydraulic Oil Filter Transmission... H-65030		HD180-4 (DUMP TRUCKS) NT0-6 Hydraulic Oil Filter..... H-5620 Hydraulic Oil Filter..... H-5611		HD325-3 (DUMP TRUCKS) KT-1150 Hydraulic Oil Filter..... H-5609	
H-90 SERIES B (CONSTRUCTION EQUIPMENTS) 4-71 Hydraulic Oil Filter Transmission... H-65030		HD1500-7 (DUMP TRUCKS) KOMATSU SDA16V159E-2 Hydraulic Oil Filter..... H-56740		HD325-3 (DUMP TRUCKS) KT-1150/1501 Hydraulic Oil Filter..... H-5609	
H-90 SERIES B (CONSTRUCTION EQUIPMENTS) C-175 Hydraulic Oil Filter Transmission... H-65030		HD180-2 / 2 (DUMP TRUCKS) NT0-6 Hydraulic Oil Filter..... H-5620 Hydraulic Oil Filter..... H-5611		HD325-5 (DUMP TRUCKS) S/N: 2001 Hydraulic Oil Filter..... H-5609	
H-90 SERIES C (CONSTRUCTION EQUIPMENTS) V6R-180-C1 Hydraulic Oil Filter Transmission... H-65030		HD180-4 / 956 (DUMP TRUCKS) NT0-6-B Hydraulic Oil Filter..... H-5611 Hydraulic Oil Filter..... H-5620		HD325-6 (DUMP TRUCKS) Hydraulic Oil Filter..... H-5618 Hydraulic Oil Filter..... H-5609	
H-90 SERIES C (LOADERS) DT573 Hydraulic Oil Filter..... H-5640		HD200-2 (DUMP TRUCKS) NTC-743/1774 Hydraulic Oil Filter..... H-5620 Hydraulic Oil Filter..... H-5611		HD325-6 (DUMP TRUCKS) SA6D140 Hydraulic Oil Filter..... H-5609 Hydraulic Oil Filter..... H-5618	
H-90 SERIES C (LOADERS) DVT-573 Hydraulic Oil Filter..... H-5640		HD200-2 (DUMP TRUCKS) NTC-743/1002 Hydraulic Oil Filter..... H-5611 Hydraulic Oil Filter..... H-5620		HD325-7 (DUMP TRUCKS) SAA6D140E-5 Hydraulic Oil Filter..... H-5609 Hydraulic Oil Filter..... H-5618	
H90C (LOADERS) Hydraulic Oil Filter..... H-5640		HD200D-3 (DUMP TRUCKS) S6D125-1/1001 Hydraulic Oil Filter..... H-5609 Hydraulic Oil Filter..... H-5611		HD465-5 (LOADERS) Hydraulic Oil Filter..... H-5618 Hydraulic Oil Filter..... H-7911	
H90E (CONSTRUCTION EQUIPMENTS) DT573 Hydraulic Oil Filter..... H-5640		HD205-3 (DUMP TRUCKS) S6D125-1/1003 Hydraulic Oil Filter..... H-5609		HD405-6 (DUMP TRUCKS) SAA6D140E Hydraulic Oil Filter..... H-5609	
H90E (CONSTRUCTION EQUIPMENTS) Hydraulic Oil Filter..... H-5640		HD255-5 (DUMP TRUCKS) SA6D125E-2/1001 Hydraulic Oil Filter..... H-5609 Hydraulic Oil Filter..... H-5618		HD460 (DUMP TRUCKS) VT-1710 Hydraulic Oil Filter..... H-5610 Hydraulic Oil Filter..... H-56600 Hydraulic Oil Filter..... H-5609	
HA270 (DUMP TRUCKS) 65226 Hydraulic Oil Filter..... H-7972		HD320-2 (DUMP TRUCKS) NTA-855 Hydraulic Oil Filter..... H-5610 Hydraulic Oil Filter..... H-56600		HD465-7 (DUMP TRUCKS) SAA6D170E Hydraulic Oil Filter..... H-5618	
HB215LC-1/HYBRID (EXCAVATORS) SAA4D107E-1 , 2011 Hydraulic Oil Filter Tank Breather... H-56610 Hydraulic Oil Filter..... H-5629		HD320-3 (DUMP TRUCKS) NTA-855 Hydraulic Oil Filter..... H-5609		HD465-7E0 (DUMP TRUCKS) SAA6D170E-5 Hydraulic Oil Filter..... H-5618	
HB205LC-1 / HYBRID (EXCAVATORS) SAA4D107E-1-A Hydraulic Oil Filter Tank Breather... H-56610 Hydraulic Oil Filter..... H-5629		HD320-3 (DUMP TRUCKS) NTA-855/2501 Hydraulic Oil Filter..... H-5609		HD605-5 (DUMP TRUCKS) KOMATSU SAA6D170E Hydraulic Oil Filter..... H-56740	
HD1200M (DUMP TRUCKS) KT2300 Hydraulic Oil Filter..... H-5606		HD325-2 (DUMP TRUCKS) KT-1150 Hydraulic Oil Filter..... H-56600 Hydraulic Oil Filter..... H-5610		HD605-5 (DUMP TRUCKS) SA6D170E	
HD1200M (DUMP TRUCKS) KTA-2300 Hydraulic Oil Filter..... H-5606					
HD1200M-1 (DUMP TRUCKS) S/N: 1501 Hydraulic Oil Filter..... H-7911					
HD1600M-1 (DUMP TRUCKS) KTA-3067/1005 Hydraulic Oil Filter..... H-7911					



ENGINE APPLICATION

MODEL/APPLICATION	SAKURA NO	MODEL/APPLICATION	SAKURA NO	MODEL/APPLICATION	SAKURA NO
KOMATSU		KOMATSU		KOMATSU	
HD605-5 (DUMP TRUCKS) SAA6D170E		HM300-2 (DUMP TRUCKS) SAA6D125E-5 , 2006		L-150 (CONSTRUCTION EQUIPMENTS) UD282F6	
Hydraulic Oil Filter.....	H-7911	Hydraulic Oil Filter.....	H-5609	Hydraulic Oil Filter Transmission...	H-65030
HD605-5 (DUMP TRUCKS) SAA6D170E		HM300-1 (DUMP TRUCKS) SAA6D125E		L-150 (LOADERS)	
Hydraulic Oil Filter.....	H-7911	Hydraulic Oil Filter.....	H-5609	Hydraulic Oil Filter Transmission...	H-65030
HD605-7 (DUMP TRUCKS) SAA6D170E		HM300-3 (DUMP TRUCKS) SAA6D125E-6 , 2012		L 175B (CONSTRUCTION EQUIPMENTS)	
Hydraulic Oil Filter.....	H-7911	Hydraulic Oil Filter.....	H-5629	Hydraulic Oil Filter Transmission...	H-65030
HD605-7E0 (DUMP TRUCKS) SAA6D170E-5		HM400-3 (DUMP TRUCKS) SAA6D140E-6 , 2012		L-175E (LOADERS)	
Hydraulic Oil Filter.....	H-5618	Hydraulic Oil Filter.....	H-5629	Hydraulic Oil Filter.....	H-5405
HD785-7 (DUMP TRUCKS) SAA12V140E-3 , 2007		HM400-3 (DUMP TRUCKS) SAA6D140E-5/STAGE IIIB/TIER 4 , 2012		Hydraulic Oil Filter.....	H-5406
Hydraulic Oil Filter.....	H-5618	Hydraulic Oil Filter.....	H-5629	L-250A (LOADERS) DT429	
HD785 (DUMP TRUCKS) KTA-2300		HO (CONSTRUCTION EQUIPMENTS) WXLC-3		Hydraulic Oil Filter.....	H-5405
Hydraulic Oil Filter.....	H-5606	Hydraulic Oil Filter Transmission...	H-65030	LW160-1 (CRANES) S/N: 1004	
HD785-1 (DUMP TRUCKS) KT2300		IHC DROTT 150 (LOADERS)		Hydraulic Oil Filter.....	H-5607
Hydraulic Oil Filter.....	H-5609	Hydraulic Oil Filter Transmission...	H-65030	Hydraulic Oil Filter.....	H-7911
Hydraulic Oil Filter.....	H-7911	JH80C (LOADERS) PD6T04		LW200L-1 (CRANES) S/N: 1001	
HD785-1 (DUMP TRUCKS) KTA-2300		Hydraulic Oil Filter.....	H-5618	Hydraulic Oil Filter.....	H-5607
Hydraulic Oil Filter.....	H-7911	JV100-1 (DOZERS)		Hydraulic Oil Filter.....	H-7911
Hydraulic Oil Filter.....	H-5609	Hydraulic Oil Filter.....	H-5611	LW250L-1 (CRANES) S/N: 1001	
HD785-2 (DUMP TRUCKS) SA8V1710		JV100A-1 (EQUIPMENT) S6D105		Hydraulic Oil Filter.....	H-7911
Hydraulic Oil Filter.....	H-7911	Hydraulic Oil Filter.....	H-5611	(ENGINES) 614TA	
Hydraulic Oil Filter.....	H-5609	JV100WA-1 (PAVING EQUIPMENT) S6D105		Hydraulic Oil Filter.....	H-7911
HD785-3 (DUMP TRUCKS) SA12V140		Hydraulic Oil Filter.....	H-5611	(ENGINES) 6D105	
Hydraulic Oil Filter.....	H-7911	JV100WP-1 (PAVING EQUIPMENT) S6D105		Hydraulic Oil Filter.....	H-5609
Hydraulic Oil Filter.....	H-5618	Hydraulic Oil Filter.....	H-5611	(ENGINES) 6D105-1	
Hydraulic Oil Filter.....	H-7911	L100 (CONSTRUCTION EQUIPMENTS) IHC		Hydraulic Oil Filter.....	H-7911
HD785-5 (DUMP TRUCKS) SA12V140		Hydraulic Oil Filter Transmission...	H-65030	(ENGINES) 6D125	
Hydraulic Oil Filter.....	H-5618	L100 (CONSTRUCTION EQUIPMENTS) NH220		Hydraulic Oil Filter.....	H-56600
Hydraulic Oil Filter.....	H-7911	Hydraulic Oil Filter Transmission...	H-65030	Hydraulic Oil Filter.....	H-5610
HD7855LC (DUMP TRUCKS) SAA12V140ZE-2 , 2011		L100 (CONSTRUCTION EQUIPMENTS) NH250		Hydraulic Oil Filter.....	H-5607
Hydraulic Oil Filter.....	H-7911	Hydraulic Oil Filter Transmission...	H-65030	(ENGINES) S4D102E-1	
HD985-3 (DUMP TRUCKS) SA12V140-1		L100 (CONSTRUCTION EQUIPMENTS) NH250		Hydraulic Oil Filter.....	H-56600
Hydraulic Oil Filter.....	H-5618	Hydraulic Oil Filter Transmission...	H-65030	Hydraulic Oil Filter.....	H-5610
Hydraulic Oil Filter.....	H-7911	L100 (CONSTRUCTION EQUIPMENTS) NT-855		(ENGINES) S6D102E-1	
HH (CONSTRUCTION EQUIPMENTS) DJXH		Hydraulic Oil Filter Transmission...	H-65030	Hydraulic Oil Filter.....	H-5607
Hydraulic Oil Filter Transmission...	H-65030	L125B (CONSTRUCTION EQUIPMENTS)		(ENGINES) S6D125	
HM300 (DUMP TRUCKS)		Hydraulic Oil Filter Transmission...	H-65030	Hydraulic Oil Filter.....	H-5607
Hydraulic Oil Filter.....	H-5609	Hydraulic Oil Filter Transmission...	H-65030	Hydraulic Oil Filter.....	H-56600



ENGINE APPLICATION

MODEL/APPLICATION	SAKURA NO	MODEL/APPLICATION	SAKURA NO	MODEL/APPLICATION	SAKURA NO
KOMATSU		KOMATSU		KOMATSU	
(ENGINES) S6D125		(ENGINES) SAA6D114E		Hydraulic Oil Filter.....	H-56600
Hydraulic Oil Filter.....	H-5610	Hydraulic Oil Filter.....	H-5629	PC100 (EXCAVATORS) S4D105	
(ENGINES) S6D125-1		(ENGINES) SAA6D114E-3		Hydraulic Oil Filter.....	H-5610
Hydraulic Oil Filter.....	H-5609	Hydraulic Oil Filter.....	H-5629	Hydraulic Oil Filter.....	H-56600
Hydraulic Oil Filter.....	H-5618	(ENGINES) SAA6D114E-3/69001		PC1000 (EXCAVATORS) SA6D170	
(ENGINES) S6D140-1		Hydraulic Oil Filter.....	H-5607	Hydraulic Oil Filter.....	H-7911
Hydraulic Oil Filter.....	H-5609	(ENGINES) SAA6D108		PC1000-1 (EXCAVATORS) SA6D170B-1/10001	
Hydraulic Oil Filter.....	H-5618	Hydraulic Oil Filter.....	H-7911	Hydraulic Oil Filter.....	H-7911
(ENGINES) S6D170-1		(ENGINES) SDA12V140E		Hydraulic Oil Filter Return.....	HC-5603
Hydraulic Oil Filter.....	H-5609	Hydraulic Oil Filter.....	H-5609	PC1000-1 (EXCAVATORS) SA6D170B-1/10001/11763	
Hydraulic Oil Filter.....	H-5618	(GRADERS)		Hydraulic Oil Filter Return.....	HC-5603
(ENGINES) S6D170E		Hydraulic Oil Filter.....	H-5607	Hydraulic Oil Filter.....	H-7911
Hydraulic Oil Filter.....	H-5618	Hydraulic Oil Filter.....	H-5620	PC1000LC-1 (EXCAVATORS) S6D170-1/10001	
(ENGINES) S6D95L		P8 (DOZERS) S/N: 45001		Hydraulic Oil Filter Return.....	HC-5603
Hydraulic Oil Filter.....	H-7911	Hydraulic Oil Filter.....	H-5620	Hydraulic Oil Filter.....	H-7911
(ENGINES) S6D95L-1GG		Hydraulic Oil Filter.....	H-5601	PC1000LC-1 (EXCAVATORS) SA6D170B-1/10001	
Hydraulic Oil Filter.....	H-5610	PC02-1 (EXCAVATORS) 2D94		Hydraulic Oil Filter.....	H-7911
Hydraulic Oil Filter.....	H-56600	Hydraulic Oil Filter.....	H-5608	Hydraulic Oil Filter Return.....	HC-5603
(ENGINES) S6D125-1T		PC02-1 (EXCAVATORS) 2D92/11701-UP		PC1000SE-1 (EXCAVATORS) S6D170-1/10001	
Hydraulic Oil Filter.....	H-7911	Hydraulic Oil Filter.....	H-5608	Hydraulic Oil Filter.....	H-7911
(ENGINES) SAA6D114-1		PC04 (EXCAVATORS) 2D94-2		Hydraulic Oil Filter Return.....	HC-5603
Hydraulic Oil Filter.....	H-7911	Hydraulic Oil Filter.....	H-5608	Hydraulic Oil Filter.....	H-7911
(ENGINES) SAA6D125		Hydraulic Oil Filter.....	H-5607	PC100-1 (EXCAVATORS) S4D105-5	
Hydraulic Oil Filter.....	H-5610	PC04 (INDUSTRIAL EQUIPMENTS, ENGINES)		Hydraulic Oil Filter.....	H-56600
Hydraulic Oil Filter.....	H-56600	Hydraulic Oil Filter.....	H-5607	Hydraulic Oil Filter.....	H-5610
(ENGINES) SAA6D125E		Hydraulic Oil Filter.....	H-5608	PC100-1SER (INDUSTRIAL EQUIPMENTS, ENGINES)	
Hydraulic Oil Filter.....	H-2709	PC04-1 (EXCAVATORS) 2D94		Hydraulic Oil Filter.....	H-56600
(ENGINES) SAA6D125E-3/67001/69000		Hydraulic Oil Filter.....	H-5608	Hydraulic Oil Filter.....	H-5610
Hydraulic Oil Filter.....	H-5607	PC04-1 (SHOVELS) 2D92		PC100-2 (EXCAVATORS) S4D105-5	
(ENGINES) SAA6D108		Hydraulic Oil Filter.....	H-5608	Hydraulic Oil Filter.....	H-56600
Hydraulic Oil Filter.....	H-7911	Hydraulic Oil Filter.....	H-5607	Hydraulic Oil Filter.....	H-5610
(ENGINES) SAA12V140		PC100 (EXCAVATORS) 6D95L		PC100-2SER (INDUSTRIAL EQUIPMENTS, ENGINES)	
Hydraulic Oil Filter.....	H-5618	Hydraulic Oil Filter.....	H-5610	Hydraulic Oil Filter.....	H-5610
(ENGINES) SAA6D102E		Hydraulic Oil Filter.....	H-56600	Hydraulic Oil Filter.....	H-56600
Hydraulic Oil Filter.....	H-5629	PC100 (EXCAVATORS) S4D105-5		Hydraulic Oil Filter.....	H-56600
		Hydraulic Oil Filter.....	H-5610	Hydraulic Oil Filter.....	H-5610



ENGINE APPLICATION

MODEL/APPLICATION	SAKURA NO	MODEL/APPLICATION	SAKURA NO	MODEL/APPLICATION	SAKURA NO
KOMATSU		KOMATSU		KOMATSU	
PC100-3 (EXCAVATORS) 6D95L-1/18001/10001/20188		PC10-1 (EXCAVATORS) 2D94-1		PC120 (EXCAVATORS) S4D95L	
Hydraulic Oil Filter.....	H-56600	Hydraulic Oil Filter.....	HC-5602	Hydraulic Oil Filter.....	H-5610
Hydraulic Oil Filter.....	H-5610			Hydraulic Oil Filter.....	H-56600
PC100-3 (EXCAVATORS) 6D95L-1/18001/20188		PC10-2 (EXCAVATORS) 3D72-1		PC120 (EXCAVATORS) S4D105	
Hydraulic Oil Filter.....	H-5610	Hydraulic Oil Filter.....	HC-5602	Hydraulic Oil Filter.....	H-56600
Hydraulic Oil Filter.....	H-56600			Hydraulic Oil Filter.....	H-5610
PC100-3SER (INDUSTRIAL EQUIPMENTS, ENGINES)		PC10-3 (EXCAVATORS) 3D72-1		PC120-1 (EXCAVATORS) S4D105-5	
Hydraulic Oil Filter.....	H-5610	Hydraulic Oil Filter.....	HC-5602	Hydraulic Oil Filter.....	H-5610
Hydraulic Oil Filter.....	H-56600			Hydraulic Oil Filter.....	H-56600
PC100-5 (EXCAVATORS) S4D95L		PC10-5 (EXCAVATORS) 3D75-2/7001		PC120-2 (EXCAVATORS) S4D105-5	
Hydraulic Oil Filter.....	H-5610	Hydraulic Oil Filter.....	H-5607	Hydraulic Oil Filter.....	H-56600
Hydraulic Oil Filter.....	H-56600			Hydraulic Oil Filter.....	H-5610
PC100-5 (EXCAVATORS) S4D95L-1/28001		PC10-6 (EXCAVATORS) 3D75-2/10501/3044		PC120-3 (EXCAVATORS) 4D95L-1	
Hydraulic Oil Filter.....	H-56600	Hydraulic Oil Filter.....	H-5625	Hydraulic Oil Filter.....	H-56600
Hydraulic Oil Filter.....	H-5610			Hydraulic Oil Filter.....	H-5610
PC100-5 (EXCAVATORS) S4D95L-1/28001/48797		PC10-6 (EXCAVATORS) 3D75-2/10501		PC120-3 (EXCAVATORS) 6D125-1/18001	
Hydraulic Oil Filter.....	H-5610	Hydraulic Oil Filter.....	H-5625	Hydraulic Oil Filter.....	H-56600
Hydraulic Oil Filter.....	H-56600			Hydraulic Oil Filter.....	H-5610
PC100-6 (EXCAVATORS) S4D102E-1/42554		PC1100-1 (EXCAVATORS) SAA6D170		PC120-3 (EXCAVATORS) 6D95L	
Hydraulic Oil Filter.....	H-56600	Hydraulic Oil Filter.....	H-5652	Hydraulic Oil Filter.....	H-5610
Hydraulic Oil Filter.....	H-5610	Hydraulic Oil Filter Return.....	HC-5603	Hydraulic Oil Filter.....	H-56600
PC100-6 (EXCAVATORS) S4D95L		Hydraulic Oil Filter.....	H-2709	PC120-3 (EXCAVATORS) 6D95L-1/18001	
Hydraulic Oil Filter.....	H-56600			Hydraulic Oil Filter.....	H-5610
Hydraulic Oil Filter.....	H-5610	PC1100-6 (EXCAVATORS) SAA6D170		Hydraulic Oil Filter.....	H-56600
PC100-6 (EXCAVATORS) S4D95L-1/40001 - 42553		Hydraulic Oil Filter.....	H-2709	PC120-3 (EXCAVATORS) 6D95L-1/18001/10001/20188	
Hydraulic Oil Filter.....	H-5610	Hydraulic Oil Filter.....	H-5652	Hydraulic Oil Filter.....	H-56600
Hydraulic Oil Filter.....	H-56600	Hydraulic Oil Filter Return.....	HC-5603	Hydraulic Oil Filter.....	H-5610
PC100-6 (EXCAVATORS) S4D95L-1/40001/143760		PC1100LC-6 (EXCAVATORS) SAA6D170		PC120-3 (EXCAVATORS) 6D95L-1/18001/20188	
Hydraulic Oil Filter.....	H-56600	Hydraulic Oil Filter.....	H-5652	Hydraulic Oil Filter.....	H-56600
Hydraulic Oil Filter.....	H-5610	Hydraulic Oil Filter.....	H-2709	Hydraulic Oil Filter.....	H-5610
PC100D-2 (EXCAVATORS) S4D105-5		Hydraulic Oil Filter Return.....	HC-5603	PC120-5 (EXCAVATORS) S4D95L	
Hydraulic Oil Filter.....	H-56600			Hydraulic Oil Filter.....	H-5610
Hydraulic Oil Filter.....	H-5610	PC1100SE-6 (EXCAVATORS) SAA6D170E-2/10001		Hydraulic Oil Filter.....	H-56600
PC100L-2 (EXCAVATORS) S4D105-5		Hydraulic Oil Filter.....	H-2709	PC120-5 (EXCAVATORS) S4D95L-1/30001/48797	
Hydraulic Oil Filter.....	H-56600	Hydraulic Oil Filter.....	H-5652	Hydraulic Oil Filter.....	H-5610
Hydraulic Oil Filter.....	H-5610	Hydraulic Oil Filter Return.....	HC-5603	Hydraulic Oil Filter.....	H-56600
PC100SS-2 (EXCAVATORS) S4D105-5		PC12 (EXCAVATORS) 3TN66E		PC120-5 (EXCAVATORS) S4D95L-1/30001	
Hydraulic Oil Filter.....	H-56600	Hydraulic Oil Filter.....	H-5607	Hydraulic Oil Filter.....	H-5610
Hydraulic Oil Filter.....	H-5610			Hydraulic Oil Filter.....	H-56600



ENGINE APPLICATION

MODEL/APPLICATION	SAKURA NO	MODEL/APPLICATION	SAKURA NO	MODEL/APPLICATION	SAKURA NO
KOMATSU					
PC120-6 (EXCAVATORS)		Hydraulic Oil Filter Return.....	HC-5603	PC130-7 (EXCAVATORS) SAA4D95LE	
Hydraulic Oil Filter.....	H-5610	Hydraulic Oil Filter Tank Breather..	H-56610	Hydraulic Oil Filter.....	H-56600
Hydraulic Oil Filter.....	H-56600	Hydraulic Oil Filter.....	H-5618		
PC120-6 (EXCAVATORS) S495L-1/45001/143760		PC1250LC-8 (EXCAVATORS) SAA6D170E-5		PC138-2 (EXCAVATORS) 2008	
Hydraulic Oil Filter.....	H-56600	Hydraulic Oil Filter Return.....	HC-5603	Hydraulic Oil Filter.....	H-56650
Hydraulic Oil Filter.....	H-5610	Hydraulic Oil Filter.....	H-5618		
PC120-6 (EXCAVATORS) S4D102E		PC1250SP-7 (EXCAVATORS) SAA6D170E-3		PC138US-2 (EXCAVATORS) 2008	
Hydraulic Oil Filter.....	H-56600	Hydraulic Oil Filter.....	H-5618	Hydraulic Oil Filter.....	H-56650
Hydraulic Oil Filter.....	H-5610	Hydraulic Oil Filter Tank Breather..	H-56610		
PC120-6 (EXCAVATORS) S4D102E-1/57001		Hydraulic Oil Filter Return.....	HC-5603	PC138US-8 (EXCAVATORS) SAA4D95LE , 2007	
Hydraulic Oil Filter.....	H-5610	Hydraulic Oil Filter.....	H-2709	Hydraulic Oil Filter.....	H-56650
Hydraulic Oil Filter.....	H-56600				
PC120-6 (EXCAVATORS) S4D95L		PC1250SP-8 (EXCAVATORS) SAA6D170E-5		PC15 (EXCAVATORS) 3TN66E	
Hydraulic Oil Filter.....	H-56600	Hydraulic Oil Filter.....	H-5618	Hydraulic Oil Filter.....	H-5607
Hydraulic Oil Filter.....	H-5610	Hydraulic Oil Filter Return.....	HC-5603		
PC120-6 (EXCAVATORS) S4D95L-1/45001/143760		PC128US-1 (EXCAVATORS) S4D102E		PC150 (EXCAVATORS) 6D105	
Hydraulic Oil Filter.....	H-56600	Hydraulic Oil Filter.....	H-56600	Hydraulic Oil Filter.....	H-7911
Hydraulic Oil Filter.....	H-5610				
PC120-6 (EXCAVATORS) S4D95L-1/45001/57000		PC128US-2 (EXCAVATORS) S4D102E		PC150 (EXCAVATORS) S6D95L	
Hydraulic Oil Filter.....	H-56600	Hydraulic Oil Filter.....	H-56600	Hydraulic Oil Filter.....	H-5610
Hydraulic Oil Filter.....	H-5610			Hydraulic Oil Filter.....	H-56600
PC120-6 (EXCAVATORS) S4D95L-1/45001/57000		PC128UU-1 (EXCAVATORS)		PC1500 (EXCAVATORS) S6D170	
Hydraulic Oil Filter.....	H-56600	Hydraulic Oil Filter.....	H-5609	Hydraulic Oil Filter.....	H-7911
Hydraulic Oil Filter.....	H-5610				
PC120LC-6 (EXCAVATORS) S4D102E		PC128UU-1 (EXCAVATORS) S4D102E		PC1500-1 (EXCAVATORS) KT-1150 (QTY 2)/10007	
Hydraulic Oil Filter.....	H-56600	Hydraulic Oil Filter.....	H-56600	Hydraulic Oil Filter.....	H-7911
Hydraulic Oil Filter.....	H-5610				
PC120SS-2 (EXCAVATORS) S4D105-5		PC128UU-1 (EXCAVATORS) S4D95L-1/1001 - 2346		PC1500-1 (EXCAVATORS) S6D170-1/10007/10126	
Hydraulic Oil Filter.....	H-56600	Hydraulic Oil Filter.....	H-56600	Hydraulic Oil Filter.....	H-7911
Hydraulic Oil Filter.....	H-5610				
PC1250 (EXCAVATORS)		PC128UU-1 (EXCAVATORS) S4D102E/2347/26200415		PC150-1 (EXCAVATORS) 6D105	
Hydraulic Oil Filter Return.....	HC-5603	Hydraulic Oil Filter.....	H-5610	Hydraulic Oil Filter.....	H-7911
Hydraulic Oil Filter.....	H-2709	Hydraulic Oil Filter.....	H-56600		
PC1250-7 (EXCAVATORS) SAA6D170E		PC128UU-2 (EXCAVATORS) S4D102E		PC150-1 (EXCAVATORS) 6D105-1/1001/52271	
Hydraulic Oil Filter.....	H-2709	Hydraulic Oil Filter.....	H-56600	Hydraulic Oil Filter.....	H-7911
Hydraulic Oil Filter Tank Breather..	H-56610				
Hydraulic Oil Filter Return.....	HC-5603	PC130-5K (EXCAVATORS)		PC150-1 (EXCAVATORS) 6D105-1/1001/52271	
Hydraulic Oil Filter.....	H-5618	Hydraulic Oil Filter.....	H-5610	Hydraulic Oil Filter.....	H-7911
		Hydraulic Oil Filter.....	H-56600		
PC1250-8 (EXCAVATORS) SAA6D170E-5		PC130-6 (EXCAVATORS) S4D102E-1/50356		PC150-3 (EXCAVATORS) S6D95L-1/3001	
Hydraulic Oil Filter.....	H-5618	Hydraulic Oil Filter.....	H-56600	Hydraulic Oil Filter.....	H-56600
Hydraulic Oil Filter Return.....	HC-5603	Hydraulic Oil Filter.....	H-5610	Hydraulic Oil Filter.....	H-5610
PC1250LC-7 (EXCAVATORS) SAA6D170E-3		PC130-6 (EXCAVATORS) S4D95L-1/45001 - 50355		PC150-3 (EXCAVATORS) S6D95L-1/3001/10001/33697	
Hydraulic Oil Filter.....	H-2709	Hydraulic Oil Filter.....	H-56600	Hydraulic Oil Filter.....	H-56600
		Hydraulic Oil Filter.....	H-5610	Hydraulic Oil Filter.....	H-5610
		PC150-3 (EXCAVATORS) S6D95L-1/3001/33698		PC150-3 (EXCAVATORS) S6D95L-1/3001/33698	
		Hydraulic Oil Filter.....	H-56600	Hydraulic Oil Filter.....	H-56600
		Hydraulic Oil Filter.....	H-5610		



ENGINE APPLICATION

MODEL/APPLICATION	SAKURA NO	MODEL/APPLICATION	SAKURA NO	MODEL/APPLICATION	SAKURA NO
KOMATSU		KOMATSU		KOMATSU	
PC150-3 (EXCAVATORS) S6D95L-1/3001/33698 Hydraulic Oil Filter.....	H-5610	Hydraulic Oil Filter.....	H-56600	Hydraulic Oil Filter.....	H-5610
PC150-3 (EXCAVATORS) S6D95L-1C/3001 Hydraulic Oil Filter.....	H-56600	Hydraulic Oil Filter.....	H-5610	PC180 (EXCAVATORS) PERKINS Hydraulic Oil Filter.....	H-56600
Hydraulic Oil Filter.....	H-5610	PC150LC-6 (EXCAVATORS) SA4D102E Hydraulic Oil Filter.....	H-56600	Hydraulic Oil Filter.....	H-5610
PC150-3SER (INDUSTRIAL EQUIPMENTS, ENGINES) Hydraulic Oil Filter.....	H-5610	Hydraulic Oil Filter.....	H-5610	PC180-3 (EXCAVATORS) Hydraulic Oil Filter.....	H-5610
Hydraulic Oil Filter.....	H-56600	PC150LC-6K (EXCAVATORS) SA4D102E Hydraulic Oil Filter.....	H-5610	Hydraulic Oil Filter.....	H-56600
PC150-5 (EXCAVATORS) S6D95L-1GG Hydraulic Oil Filter.....	H-56600	Hydraulic Oil Filter.....	H-5610	PC180-5K (EXCAVATORS) Hydraulic Oil Filter.....	H-5610
Hydraulic Oil Filter.....	H-5610	PC15-1 (EXCAVATORS) 3D78-1 Hydraulic Oil Filter.....	H-5607	Hydraulic Oil Filter.....	H-2706
PC150-5 (EXCAVATORS) S6D95L-1/6001/58644 Hydraulic Oil Filter.....	H-56600	Hydraulic Oil Filter.....	H-5610	Hydraulic Oil Filter.....	H-56600
Hydraulic Oil Filter.....	H-5610	PC15-1 (EXCAVATORS) 3D78-1/1001/00603 Hydraulic Oil Filter.....	H-5607	PC180-LC3 (EXCAVATORS) S6D95L-1 Hydraulic Oil Filter.....	H-56600
PC150-6 (EXCAVATORS) Hydraulic Oil Filter.....	H-56600	PC15-2 (EXCAVATORS) 3D78-1 Hydraulic Oil Filter.....	H-5607	Hydraulic Oil Filter.....	H-5610
Hydraulic Oil Filter.....	H-5610	PC15-2 (EXCAVATORS) 3D78-1/10001/02853 Hydraulic Oil Filter.....	H-5607	PC180LC-6K (EXCAVATORS) Hydraulic Oil Filter.....	H-56600
PC150-6K (EXCAVATORS) SA4D102E Hydraulic Oil Filter.....	H-56600	PC15-2 (EXCAVATORS) 3D78-1/10001/02853 Hydraulic Oil Filter.....	H-5607	PC118MR-8 (EXCAVATORS) SAA4D95LE-5 , 2011 Hydraulic Oil Filter.....	H-56650
Hydraulic Oil Filter.....	H-5610	PC158US-2 (EXCAVATORS) S4D102E-1 Hydraulic Oil Filter.....	H-56600	Hydraulic Oil Filter Tank Breather... H-56610	H-56610
PC150AV (EXCAVATORS) S6D95L Hydraulic Oil Filter.....	H-5610	PC158USLC-2 (EXCAVATORS) S4D102E-1 Hydraulic Oil Filter.....	H-56600	PC138USLC-2A (EXCAVATORS) 1501 Hydraulic Oil Filter.....	H-56650
Hydraulic Oil Filter.....	H-56600	PC1600 (EXCAVATORS) SA6D140 Hydraulic Oil Filter.....	H-7911	Hydraulic Oil Filter.....	H-5629
PC150LC-1 (EXCAVATORS) 6D105 Hydraulic Oil Filter.....	H-7911	PC160-6K (EXCAVATORS) Hydraulic Oil Filter.....	H-56600	PC160LC-8 (EXCAVATORS) SAA4D107E-1D , 2011 Hydraulic Oil Filter Tank Breather..	H-56610
PC150LC-3 (EXCAVATORS) S6D95L-1/3001 Hydraulic Oil Filter.....	H-5610	Hydraulic Oil Filter.....	H-5610	Hydraulic Oil Filter.....	H-5629
Hydraulic Oil Filter.....	H-56600	PC160-6K (EXCAVATORS) Hydraulic Oil Filter.....	H-5610	PC180LC-3 (EXCAVATORS) Hydraulic Oil Filter.....	H-5610
PC150LC-3 (EXCAVATORS) S6D95L-1/3001/10001/33697 Hydraulic Oil Filter.....	H-56600	Hydraulic Oil Filter.....	H-5610	Hydraulic Oil Filter.....	H-56600
Hydraulic Oil Filter.....	H-5610	PC160LC-7 (EXCAVATORS) SAA4D102E Hydraulic Oil Filter.....	H-5629	PC130-8 (EXCAVATORS) KOMATSU SAA4D95LE-5 Hydraulic Oil Filter additional part..	H-7105
PC150LC-3 (EXCAVATORS) S6D95L-1/3001/33698 Hydraulic Oil Filter.....	H-56600	PC160LC-7E0 (EXCAVATORS) SAA4D107E-1 Hydraulic Oil Filter Tank Breather...	H-56610	Hydraulic Oil Filter.....	H-56650
Hydraulic Oil Filter.....	H-5610	Hydraulic Oil Filter.....	H-5629	PC130-8 (EXCAVATORS) SAA4D95LE-5 Hydraulic Oil Filter.....	H-56650
PC150LC-3 (EXCAVATORS) S6D95L-1C/3001 Hydraulic Oil Filter.....	H-5610	PC160LC-7K (EXCAVATORS) SAA4D102E Hydraulic Oil Filter.....	H-5629	PC138USLC-2 (EXCAVATORS) S/N: 1501 Hydraulic Oil Filter.....	H-56650
Hydraulic Oil Filter.....	H-56600	PC170 (SHOVELS) 2007 Hydraulic Oil Filter.....	H-56600	PC20 (EXCAVATORS) 3TN75E Hydraulic Oil Filter.....	H-5607
PC150LC-6 (EXCAVATORS)				PC20 (EXCAVATORS) 3TNE74 Hydraulic Oil Filter.....	H-5607



ENGINE APPLICATION

MODEL/APPLICATION	SAKURA NO	MODEL/APPLICATION	SAKURA NO	MODEL/APPLICATION	SAKURA NO
KOMATSU		KOMATSU		KOMATSU	
PC200 (EXCAVATORS)		Hydraulic Oil Filter Tank Breather... H-56610		Hydraulic Oil Filter Tank Breather... H-56610	
Hydraulic Oil Filter..... H-5607		Hydraulic Oil Filter..... H-7911		Hydraulic Oil Filter..... H-7911	
PC200 (EXCAVATORS) 6BT5.9		PC200-5SER (INDUSTRIAL EQUIPMENTS, ENGINES)		PC200LC-6 (EXCAVATORS) S6D102E-1/96514	
Hydraulic Oil Filter..... H-5609		Hydraulic Oil Filter Tank Breather... H-56610		Hydraulic Oil Filter Tank Breather... H-56610	
PC200 (EXCAVATORS) 6D105		Hydraulic Oil Filter..... H-7911		PC200LC-7 (EXCAVATORS) SAA6D102E	
Hydraulic Oil Filter..... H-7911		PC200-6 (EXCAVATORS) S6D102E-1/96514		Hydraulic Oil Filter..... H-5629	
PC200 (EXCAVATORS) S6D105		Hydraulic Oil Filter Tank Breather... H-56610		PC200LC-7B (EXCAVATORS) SAA6D102E	
Hydraulic Oil Filter..... H-5609		Hydraulic Oil Filter..... H-7911		Hydraulic Oil Filter..... H-5629	
PC200 (EXCAVATORS) S6D95		PC200-6 (EXCAVATORS) S6D95L-1/80001/111868		PC200LC-8 (EXCAVATORS) KOMATSU SAA6D107E-1B	
Hydraulic Oil Filter..... H-7911		Hydraulic Oil Filter Tank Breather... H-56610		Hydraulic Oil Filter additional part.. H-7105	
PC2000 (EXCAVATORS)		Hydraulic Oil Filter..... H-7911		PC200LC-8 (EXCAVATORS) SAA6D107E	
Hydraulic Oil Filter..... HC-5601		PC200-6K (EXCAVATORS)		Hydraulic Oil Filter Tank Breather... H-56610	
PC2000-8 (EXCAVATORS) SAA12V140E-3 , 2007		Hydraulic Oil Filter..... H-56600		Hydraulic Oil Filter..... H-5629	
Hydraulic Oil Filter..... HC-5601		Hydraulic Oil Filter..... H-2706		PC200LL-7 (EXCAVATORS) SAA6D102E	
PC2000-8 (EXCAVATORS) SAA12V40E-3		Hydraulic Oil Filter..... H-5610		Hydraulic Oil Filter Tank Breather... H-56610	
Hydraulic Oil Filter..... HC-5601		PC200-7 (EXCAVATORS) SAA6D102E-2 , 2003		Hydraulic Oil Filter..... H-5629	
PC200-1 (EXCAVATORS) 6D105		Hydraulic Oil Filter..... H-5629		PC20-2 (EXCAVATORS) 3D75-1	
Hydraulic Oil Filter..... H-7911		PC200-7 (EXCAVATORS) SAA6D102E		Hydraulic Oil Filter..... H-5607	
PC200-1 (EXCAVATORS) S6D105		Hydraulic Oil Filter..... H-5629		PC20-3 (EXCAVATORS) 3D75-1	
Hydraulic Oil Filter..... H-7911		PC200-7B (EXCAVATORS) SAA6D102E		Hydraulic Oil Filter..... H-5607	
PC200-2 (EXCAVATORS) 6D105		Hydraulic Oil Filter..... H-5629		PC20-5 (EXCAVATORS) 3D84-1	
Hydraulic Oil Filter..... H-7911		PC200-8 (EXCAVATORS) KOMATSU SAA6D107E		Hydraulic Oil Filter..... H-5607	
PC200-3 (EXCAVATORS) S6D105		Hydraulic Oil Filter additional part.. H-7105		PC20-5 (EXCAVATORS) 3D84-1/18001/13021	
Hydraulic Oil Filter..... H-5609		PC200-8 (EXCAVATORS) SAA6D107E		Hydraulic Oil Filter..... H-5607	
PC200-3 (EXCAVATORS) S6D105-1/20001/61481/78804		Hydraulic Oil Filter Tank Breather... H-56610		PC20-6 (EXCAVATORS) 3D84-1	
Hydraulic Oil Filter..... H-5609		Hydraulic Oil Filter..... H-5629		Hydraulic Oil Filter..... H-5607	
PC200-3 (EXCAVATORS) S6D105-1/20001/78805		PC200LC-2 (EXCAVATORS) 6D105		PC20-6 (EXCAVATORS) 3D84-1/24001/25916	
Hydraulic Oil Filter..... H-5609		Hydraulic Oil Filter..... H-7911		Hydraulic Oil Filter..... H-5607	
PC200-3SER (INDUSTRIAL EQUIPMENTS, ENGINES)		PC200LC-3 (EXCAVATORS) S6D105		PC20HT-1 (EXCAVATORS) 4D130-1	
Hydraulic Oil Filter..... H-5609		Hydraulic Oil Filter..... H-5609		Hydraulic Oil Filter..... H-7911	
PC200-5 (EXCAVATORS) S6D95L-1/45001/35360		PC200LC-3 (EXCAVATORS) S6D105-1/20001/61481/78804		PC20-SER (EXCAVATORS) 3D84-1	
Hydraulic Oil Filter..... H-7911		Hydraulic Oil Filter..... H-5609		Hydraulic Oil Filter..... H-5607	
Hydraulic Oil Filter Tank Breather... H-56610		PC200LC-5 (EXCAVATORS) S6D95L-1/45001/35360		PC210 (EXCAVATORS) BT5.9	
PC200-5 (EXCAVATORS) S6D95L/45001		Hydraulic Oil Filter Tank Breather... H-56610		Hydraulic Oil Filter..... H-5609	
		Hydraulic Oil Filter..... H-7911		PC210-3 (EXCAVATORS)	
		PC200LC-5 (EXCAVATORS) S6D95L/45001		Hydraulic Oil Filter..... H-5609	



ENGINE APPLICATION

MODEL/APPLICATION	SAKURA NO	MODEL/APPLICATION	SAKURA NO	MODEL/APPLICATION	SAKURA NO
KOMATSU		KOMATSU		KOMATSU	
PC210-3 (EXCAVATORS)		PC220-1 (EXCAVATORS) S6D102E-1/10001/UP		PC220AV (EXCAVATORS) SA6D95L	
		Hydraulic Oil Filter.....	H-7911	Hydraulic Oil Filter.....	H-7911
PC210-3 (EXCAVATORS) S/N: 10001		PC220-1 (EXCAVATORS) S6D105-1		PC220LC-3 (EXCAVATORS) S6D105-1/20001/78506	
Hydraulic Oil Filter.....	H-5609	Hydraulic Oil Filter.....	H-5609	Hydraulic Oil Filter.....	H-5609
PC210-5K (EXCAVATORS)		PC220-1 (EXCAVATORS) S6D105-1		PC220LC-3 (EXCAVATORS) S6D105-1/20001/62361	
Hydraulic Oil Filter.....	H-7911	Hydraulic Oil Filter.....	H-7911	Hydraulic Oil Filter.....	H-5609
PC210-6 (EXCAVATORS) S6D102E-1/30980		PC220-2SER (EXCAVATORS) S6D102E-1		PC220LC-5 (EXCAVATORS) SA6D95L-1/35001	
Hydraulic Oil Filter Tank Breather...	H-56610	Hydraulic Oil Filter.....	H-7911	Hydraulic Oil Filter Tank Breather...	H-56610
PC210-6 (EXCAVATORS) S6D95L-1/30001/111868		PC220-2SER (EXCAVATORS) S6D102E-1/10001/UP		Hydraulic Oil Filter.....	H-7911
Hydraulic Oil Filter Tank Breather...	H-56610	Hydraulic Oil Filter.....	H-7911		
Hydraulic Oil Filter.....	H-7911	PC220-2SER (INDUSTRIAL EQUIPMENTS, ENGINES)		PC220LC-6 (EXCAVATORS) SA6D95L-1/50001	
PC210-6 (EXCAVATORS) S6D95L-1/30001/30979/111868		Hydraulic Oil Filter.....	H-7911	Hydraulic Oil Filter Tank Breather...	H-56610
Hydraulic Oil Filter Tank Breather...	H-56610	PC220-3 (EXCAVATORS) S6D105-1/20001/78506		Hydraulic Oil Filter.....	H-7911
Hydraulic Oil Filter.....	H-7911	Hydraulic Oil Filter.....	H-5609	PC220LC-6 (EXCAVATORS) SA6D102E-1/52852	
PC210-6K (EXCAVATORS)		PC220-3SER (INDUSTRIAL EQUIPMENTS, ENGINES)		Hydraulic Oil Filter Tank Breather...	H-56610
Hydraulic Oil Filter.....	H-7911	Hydraulic Oil Filter.....	H-5609	PC220LC-7 (EXCAVATORS) SAA6D102E	
PC210-7 (EXCAVATORS) SAA6D102E , 2004		PC220-5 (EXCAVATORS) SA6D95L-1/35001		Hydraulic Oil Filter.....	H-5629
Hydraulic Oil Filter.....	H-5629	Hydraulic Oil Filter.....	H-7911	PC220LC-8 (EXCAVATORS) KOMATSU SAA6D107E-1C-W1	
PC210-7K (EXCAVATORS) SAA6D102E , 2004		Hydraulic Oil Filter Tank Breather...	H-56610	Hydraulic Oil Filter additional part..	H-7105
Hydraulic Oil Filter.....	H-5629	PC220-6 (EXCAVATORS) SA6D95L-1/50001		PC220LC-8 (EXCAVATORS) SAA6D107E	
PC210-8 (EXCAVATORS) SAA6D107E , 2006		Hydraulic Oil Filter.....	H-7911	Hydraulic Oil Filter.....	H-5629
Hydraulic Oil Filter.....	H-5629	Hydraulic Oil Filter Tank Breather...	H-56610	PC220LL-7 (EXCAVATORS) SAA6D102E	
PC210LC-6 (EXCAVATORS) S6D102E-1/30980		PC220-6 (EXCAVATORS) SA6D102E-1/52852		Hydraulic Oil Filter.....	H-5629
Hydraulic Oil Filter Tank Breather...	H-56610	Hydraulic Oil Filter Tank Breather...	H-56610	PC228 (EXCAVATORS) S6D102E	
PC210LC-6 (EXCAVATORS) S6D95L-1/30001/111868		PC220-6SER (INDUSTRIAL EQUIPMENTS, ENGINES)		Hydraulic Oil Filter.....	H-5609
Hydraulic Oil Filter.....	H-7911	Hydraulic Oil Filter.....	H-7911	PC228S (EXCAVATORS) 2003	
Hydraulic Oil Filter Tank Breather...	H-56610	PC220-7 (EXCAVATORS)		Hydraulic Oil Filter.....	H-5629
PC210LC-6 (EXCAVATORS) S6D95L-1/30001/30979/111868		Hydraulic Oil Filter.....	H-5629	PC228US-1 (EXCAVATORS) S6D102E	
Hydraulic Oil Filter.....	H-7911	Hydraulic Oil Filter Tank Breather...	H-56610	Hydraulic Oil Filter.....	H-5609
Hydraulic Oil Filter Tank Breather...	H-56610	PC220-7 (EXCAVATORS) SAA6D102E		PC228US-2 (EXCAVATORS) S6D102E	
PC210LC-7K (EXCAVATORS)		Hydraulic Oil Filter.....	H-5629	Hydraulic Oil Filter.....	H-5609
Hydraulic Oil Filter.....	H-5629	Hydraulic Oil Filter Tank Breather...	H-56610	PC228US-3 (EXCAVATORS) SAA6D102E , 2004	
PC220 (EXCAVATORS) S6D105		PC220-8 (EXCAVATORS) KOMATSU SAA6D107E		Hydraulic Oil Filter.....	H-5629
Hydraulic Oil Filter.....	H-5609	Hydraulic Oil Filter additional part..	H-7105	PC228USLC-1 (EXCAVATORS) S6D102E	
PC220-1 (EXCAVATORS) S6D102E-1		PC220-8 (EXCAVATORS) SAA6D107E		Hydraulic Oil Filter.....	H-5609
Hydraulic Oil Filter.....	H-7911	Hydraulic Oil Filter.....	H-5629		



ENGINE APPLICATION

MODEL/APPLICATION	SAKURA NO	MODEL/APPLICATION	SAKURA NO	MODEL/APPLICATION	SAKURA NO
KOMATSU		KOMATSU		KOMATSU	
PC228USLC-2 (EXCAVATORS) S6D102E		PC240-3SER (EXCAVATORS) S6D105-1		PC290-7 (EXCAVATORS)	
Hydraulic Oil Filter.....	H-5609	Hydraulic Oil Filter.....	H-5609	Hydraulic Oil Filter.....	H-5629
PC228USLC-3 (EXCAVATORS) SAA6D102E		PC240-5K (EXCAVATORS)		Hydraulic Oil Filter Tank Breather..	H-56610
Hydraulic Oil Filter.....	H-5629	Hydraulic Oil Filter.....	H-7911	PC290-8 (EXCAVATORS) 2006	
PC228USLC-3EO (EXCAVATORS) SAA6D107E-1		PC240-6K (EXCAVATORS)		Hydraulic Oil Filter.....	H-5629
Hydraulic Oil Filter.....	H-5629	Hydraulic Oil Filter.....	H-7911	PC290LC-6K (EXCAVATORS) SAA6D102EA-1/K30001-UP/21288263-UP	
PC228UU-1 (EXCAVATORS) S6D102E		PC240-8 (EXCAVATORS) 2006		Hydraulic Oil Filter Tank Breather..	H-56610
Hydraulic Oil Filter.....	H-5609	Hydraulic Oil Filter.....	H-5629	Hydraulic Oil Filter.....	H-2706
PC230-6 (EXCAVATORS) S6D95L-1/20001/UP		PC240LC (EXCAVATORS) S6D102		PC290NLC-6K (EXCAVATORS)	
Hydraulic Oil Filter.....	H-7911	Hydraulic Oil Filter.....	H-5609	Hydraulic Oil Filter.....	H-7911
Hydraulic Oil Filter Tank Breather..	H-56610	PC250LC-6 (EXCAVATORS) SAA6D102-1/A82001		PC290NLC-7K (EXCAVATORS) 2006	
PC230-6 (EXCAVATORS) SAA6D95L-1/10001/111870		Hydraulic Oil Filter.....	H-7911	Hydraulic Oil Filter.....	H-5629
Hydraulic Oil Filter.....	H-7911	PC25-1 (EXCAVATORS) 3D84N-2		Hydraulic Oil Filter Tank Breather..	H-56610
Hydraulic Oil Filter Tank Breather..	H-56610	Hydraulic Oil Filter.....	H-5607	PC210NLC-7K (EXCAVATORS) SAA6D102E , 2004	
PC230-6 (EXCAVATORS) SAA6D102E-1/10177		PC25-1 (EXCAVATORS) 3D82E-3/6471		Hydraulic Oil Filter.....	H-5629
Hydraulic Oil Filter Tank Breather..	H-56610	Hydraulic Oil Filter.....	H-5607	PC210NLC-8K (EXCAVATORS) SAA6D107E-1	
PC230-6 (EXCAVATORS) SAA6D95L-1/10001/10176		PC25-1 (EXCAVATORS) 3D84N-2/1001/6470		Hydraulic Oil Filter Tank Breather..	H-56610
Hydraulic Oil Filter Tank Breather..	H-56610	Hydraulic Oil Filter.....	H-5607	Hydraulic Oil Filter.....	H-5629
Hydraulic Oil Filter.....	H-7911	PC270-7 (EXCAVATORS) SAA6D102E		PC228USLC-9 (EXCAVATORS) SAA6D107E-1K	
PC230LC-6 (EXCAVATORS) SAA6D95L-1/10001/111870		Hydraulic Oil Filter.....	H-5629	Hydraulic Oil Filter.....	H-5629
Hydraulic Oil Filter Tank Breather..	H-56610	PC270LC-7MH (EXCAVATORS) SAA6D102E		PC230NHD-8 (SHOVELS) KOMATSU , 2007	
Hydraulic Oil Filter.....	H-7911	Hydraulic Oil Filter.....	H-5629	Hydraulic Oil Filter.....	H-5629
PC230LC-6 (EXCAVATORS) SAA6D102E-1/10177		Hydraulic Oil Filter Tank Breather..	H-56610	PC240LC-8 (EXCAVATORS) KOMATSU SAA6D107E-1	
Hydraulic Oil Filter Tank Breather..	H-56610	PC270LC-8 (EXCAVATORS) SAA6D107E-1		Hydraulic Oil Filter additional part..	H-7105
Hydraulic Oil Filter.....	H-7911	Hydraulic Oil Filter.....	H-5629	PC240LC-8 (EXCAVATORS) SAA6D107E-1	
PC230LC-6 (EXCAVATORS) SAA6D95L-1/10001/10176		PC270LL-7 (EXCAVATORS) SAA6D102E		Hydraulic Oil Filter.....	H-5629
Hydraulic Oil Filter.....	H-7911	Hydraulic Oil Filter.....	H-5629	Hydraulic Oil Filter Tank Breather..	H-56610
Hydraulic Oil Filter Tank Breather..	H-56610	Hydraulic Oil Filter Tank Breather..	H-56610	PC240LC-8K (EXCAVATORS) SAA6D107E-1	
PC230NHD-7 (EXCAVATORS) SAA6D102E-2		PC280-3 (EXCAVATORS) S/N: 10001		Hydraulic Oil Filter.....	H-5629
Hydraulic Oil Filter.....	H-5629	Hydraulic Oil Filter.....	H-5609	Hydraulic Oil Filter Tank Breather..	H-56610
PC230NHD-7K (EXCAVATORS) SAA6D102E-2		PC280-3SER (EXCAVATORS) S6D110		PC210-8K (EXCAVATORS) KOMATSU SAA6D107E-1B-WK	
Hydraulic Oil Filter.....	H-5629	Hydraulic Oil Filter.....	H-5609	Hydraulic Oil Filter additional part..	H-7105
PC240 (EXCAVATORS)		PC280LC-3 (EXCAVATORS) S6D110-1D/10001/55860		PC210-8K (EXCAVATORS) SAA6D107E-1	
Hydraulic Oil Filter.....	H-7911	Hydraulic Oil Filter.....	H-5609	Hydraulic Oil Filter.....	H-5629
PC240-3 (EXCAVATORS)		PC280LC-3 (EXCAVATORS) S6D110-1D/10001/55860		Hydraulic Oil Filter Tank Breather..	H-56610
Hydraulic Oil Filter.....	H-5609	Hydraulic Oil Filter.....	H-5609	PC210LC-8 (EXCAVATORS) SAA6D107E , 2006	
				Hydraulic Oil Filter.....	H-5629



ENGINE APPLICATION

MODEL/APPLICATION	SAKURA NO	MODEL/APPLICATION	SAKURA NO	MODEL/APPLICATION	SAKURA NO
KOMATSU		KOMATSU		KOMATSU	
PC210LC-8K (EXCAVATORS) KOMATSU SAA6D107E-1B-WK Hydraulic Oil Filter additional part..	H-7105	Hydraulic Oil Filter.....	H-62110	PC300-7 (EXCAVATORS) KOMATSU SAA6D114E Hydraulic Oil Filter additional part..	H-7105
PC210LC-8K (EXCAVATORS) SAA6D107E-1 Hydraulic Oil Filter.....	H-5629	PC300-1 (EXCAVATORS) NT-855 Hydraulic Oil Filter.....	H-7911	PC300-7 (EXCAVATORS) SAA6D114E-2A Hydraulic Oil Filter.....	H-5629
Hydraulic Oil Filter Tank Breather...	H-56610	PC300-1SER (INDUSTRIAL EQUIPMENTS, ENGINES) Hydraulic Oil Filter.....	H-7911	PC300AV (EXCAVATORS) SAA6D108 Hydraulic Oil Filter.....	H-7911
PC240-8K (EXCAVATORS) SAA6D107E-1 Hydraulic Oil Filter.....	H-5629	PC300-2SER (INDUSTRIAL EQUIPMENTS, ENGINES) Hydraulic Oil Filter.....	H-7911	PC300AV (EXCAVATORS) SAA6D108 Hydraulic Oil Filter.....	H-7911
Hydraulic Oil Filter Tank Breather...	H-56610	PC300-3 (EXCAVATORS) S6D125-1/12001/13137 Hydraulic Oil Filter.....	H-5652	PC300HD-5 (EXCAVATORS) SAA6D108 Hydraulic Oil Filter.....	H-7911
PC240LC-10 (EXCAVATORS) SAA6D107E-2 , 2011 Hydraulic Oil Filter.....	H-5629	Hydraulic Oil Filter.....	H-7911	PC300HD-5 (EXCAVATORS) SAA6D108-1/10001 Hydraulic Oil Filter.....	H-7911
PC240NLC-7 (EXCAVATORS) SAA6D102E-2 , 2005 Hydraulic Oil Filter.....	H-5629	PC300-3SER (INDUSTRIAL EQUIPMENTS, ENGINES) Hydraulic Oil Filter.....	H-5652	Hydraulic Oil Filter.....	H-5652
PC240NLC-8 (EXCAVATORS) Hydraulic Oil Filter.....	H-5629	PC300-3SER (INDUSTRIAL EQUIPMENTS, ENGINES) Hydraulic Oil Filter.....	H-7911	PC300HD-6 (EXCAVATORS) SAA6D114 , 2004 Hydraulic Oil Filter.....	H-7911
PC240NLC-8K (EXCAVATORS) SAA6D107E-1 Hydraulic Oil Filter Tank Breather...	H-56610	PC300-5 (EXCAVATORS) S6D125-15/12239/13137 Hydraulic Oil Filter.....	H-7911	PC300HD-6 (EXCAVATORS) SAA6D114-1 , 2004 Hydraulic Oil Filter.....	H-7911
Hydraulic Oil Filter.....	H-5629	Hydraulic Oil Filter.....	H-5652	PC300HD-6MH (EXCAVATORS) SAA6D114-1 , 2004 Hydraulic Oil Filter.....	H-7911
PC270LC-7 (EXCAVATORS) SAA6D102E Hydraulic Oil Filter Tank Breather...	H-56610	PC300-5 (EXCAVATORS) S6D125-1/20001/10001 Hydraulic Oil Filter.....	H-7911	PC300HD-7 (EXCAVATORS) SAA6D114E-2A Hydraulic Oil Filter.....	H-5629
Hydraulic Oil Filter.....	H-5629	Hydraulic Oil Filter.....	H-5652	PC300HD-7L (EXCAVATORS) SAA6D114E-2A Hydraulic Oil Filter.....	H-5629
PC290LC-8K (EXCAVATORS) SAA6D107E Hydraulic Oil Filter.....	H-5629	PC300-5SER (INDUSTRIAL EQUIPMENTS, ENGINES) Hydraulic Oil Filter.....	H-7911	PC300HD-7MH (EXCAVATORS) SAA6D114E-2A Hydraulic Oil Filter.....	H-5629
PC270-8 (EXCAVATORS) KOMATSU SAA6D107E-1E-W1 Hydraulic Oil Filter additional part..	H-7105	Hydraulic Oil Filter.....	H-5652	PC300HD-8 (EXCAVATORS) SAA6D114E-3 Hydraulic Oil Filter.....	H-5629
PC30 (EXCAVATORS) 3TN84E Hydraulic Oil Filter.....	H-5607	PC300-6 (EXCAVATORS) SAA6D108 Hydraulic Oil Filter.....	H-7911	Hydraulic Oil Filter Tank Breather..	H-56610
PC30 (EXCAVATORS) Hydraulic Oil Filter.....	H-5607	PC300-6 (EXCAVATORS) SAA6D108E-2/30001/19030 Hydraulic Oil Filter.....	H-7911	PC300LC-2 (EXCAVATORS) NT-855 Hydraulic Oil Filter.....	H-7911
PC300 (EXCAVATORS) N-855 Hydraulic Oil Filter.....	H-7911	Hydraulic Oil Filter Tank Breather..	H-56610	PC300LC-3 (EXCAVATORS) S6D125-1/12001/13137 Hydraulic Oil Filter.....	H-5652
PC300 (EXCAVATORS) Hydraulic Oil Filter.....	H-7911	PC300-6SER (INDUSTRIAL EQUIPMENTS, ENGINES) Hydraulic Oil Filter.....	H-7911	Hydraulic Oil Filter.....	H-7911
PC3000 (SHOVELS) CUMMINS KTA38 , 2007 Hydraulic Oil Filter.....	H-62110	Hydraulic Oil Filter Tank Breather..	H-56610	PC300LC-3 (EXCAVATORS) S6D125-1/12001/13137 Hydraulic Oil Filter.....	H-5652
PC3000 (SHOVELS) Hydraulic Oil Filter.....	H-5629	PC300-7 (EXCAVATORS) 2004 Hydraulic Oil Filter Tank Breather..	H-56610	Hydraulic Oil Filter.....	H-7911
		Hydraulic Oil Filter.....	H-5629	PC300LC-3 (EXCAVATORS) S6D125-1S/12239/13137	



ENGINE APPLICATION

MODEL/APPLICATION	SAKURA NO	MODEL/APPLICATION	SAKURA NO	MODEL/APPLICATION	SAKURA NO
KOMATSU		KOMATSU		KOMATSU	
PC300LC-3 (EXCAVATORS) S6D125-1S/12239/13137 Hydraulic Oil Filter.....	H-7911	PC300NLC-3 (EXCAVATORS) S6D125-1/13137 Hydraulic Oil Filter.....	H-5652	Hydraulic Oil Filter.....	H-7911
PC300LC-5 (EXCAVATORS) 614TA Hydraulic Oil Filter.....	H-7911	Hydraulic Oil Filter.....	H-7911	PC340NLC-7K (EXCAVATORS) SAA6D114E-2A Hydraulic Oil Filter.....	H-5629
PC300LC-5 (EXCAVATORS) SA6D108/20001 Hydraulic Oil Filter.....	H-5652	PC30-1 (EXCAVATORS) 3D75-1 Hydraulic Oil Filter.....	H-5607	Hydraulic Oil Filter Tank Breather..	H-56610
Hydraulic Oil Filter.....	H-7911	PC30-3 (EXCAVATORS) 3D75-1 Hydraulic Oil Filter.....	H-5607	PC35 (EXCAVATORS) 3TN84E Hydraulic Oil Filter.....	H-5607
PC300LC-5 (EXCAVATORS) SA6D108-1/20001/10001 Hydraulic Oil Filter.....	H-7911	PC30-5 (EXCAVATORS) 3D84-1/16001/13021 Hydraulic Oil Filter.....	H-5607	PC350-6 (EXCAVATORS) SAA6D108E-2/10001/19030 Hydraulic Oil Filter.....	H-7911
Hydraulic Oil Filter.....	H-5652	PC30-6 (EXCAVATORS) 3D84-1/10001 Hydraulic Oil Filter.....	H-5607	Hydraulic Oil Filter Tank Breather..	H-56610
PC300LC-6 (EXCAVATORS) SA6D114 , 2004 Hydraulic Oil Filter.....	H-7911	PC30-7 (EXCAVATORS) 3D84E-3/26423 Hydraulic Oil Filter.....	H-5607	PC350-6SER (EXCAVATORS) Hydraulic Oil Filter Tank Breather..	H-56610
PC300LC-6 (EXCAVATORS) SA6D114-1 , 2004 Hydraulic Oil Filter.....	H-7911	PC30-7 (EXCAVATORS) 3D84-2/18001/26422 Hydraulic Oil Filter.....	H-5607	Hydraulic Oil Filter.....	H-7911
PC300LC-6 (EXCAVATORS) SAA6D108E-2/30001/19030 Hydraulic Oil Filter Tank Breather..	H-56610	PC30-8 (EXCAVATORS) 3D84E Hydraulic Oil Filter.....	H-5607	PC350-7 (EXCAVATORS) SAA6D114E-2A Hydraulic Oil Filter.....	H-5629
Hydraulic Oil Filter.....	H-7911	PC308USLC-3 (EXCAVATORS) SAA6D107E Hydraulic Oil Filter.....	H-5629	Hydraulic Oil Filter Tank Breather..	H-56610
PC300LC-6 (EXCAVATORS) SAA6D108 Hydraulic Oil Filter.....	H-7911	PC308USLC-3E0 (EXCAVATORS) Hydraulic Oil Filter.....	H-5629	PC350AV (EXCAVATORS) SAA6D108 Hydraulic Oil Filter.....	H-7911
PC300LC-7L (EXCAVATORS) SAA6D114E-2A Hydraulic Oil Filter.....	H-5629	PC30R-8 (EXCAVATORS) 3D84E/10001 Hydraulic Oil Filter.....	H-5607	PC350LC-6 (EXCAVATORS) SAA6D108E-2/10001/19030 Hydraulic Oil Filter Tank Breather..	H-56610
PC300LC-8 (EXCAVATORS) KOMATSU SAA6D114E-3D-WT Hydraulic Oil Filter additional part..	H-7105	PC30-SER (INDUSTRIAL EQUIPMENTS, ENGINES) Hydraulic Oil Filter.....	H-5607	Hydraulic Oil Filter.....	H-7911
PC300LC-8 (EXCAVATORS) SAA6D114E-3 Hydraulic Oil Filter.....	H-5629	PC340 (LOADERS) Hydraulic Oil Filter.....	H-5629	PC350LC-7 (EXCAVATORS) SAA6D114E-2A Hydraulic Oil Filter.....	H-5629
Hydraulic Oil Filter Tank Breather..	H-56610	PC340-6K (EXCAVATORS) Hydraulic Oil Filter.....	H-7911	PC350LC-8 (EXCAVATORS) KOMATSU , 2008 Hydraulic Oil Filter.....	H-5629
PC300LL-6 (EXCAVATORS) SA6D114-1 , 2004 Hydraulic Oil Filter.....	H-7911	Hydraulic Oil Filter Tank Breather..	H-56610	PC350LC-8 (EXCAVATORS) KOMATSU SAA6D114E-3D-WT Hydraulic Oil Filter additional part..	H-7105
PC300LL-7E0 (EXCAVATORS) SAA6D114E-3 Hydraulic Oil Filter.....	H-5629	PC340-7K (EXCAVATORS) 2006 Hydraulic Oil Filter.....	H-5629	PC350NLC- 8 (EXCAVATORS) KOMATSU , 2008 Hydraulic Oil Filter.....	H-5629
PC300LL-7L (EXCAVATORS) SAA6D114E-2A Hydraulic Oil Filter.....	H-5629	Hydraulic Oil Filter Tank Breather..	H-56610	PC35R-8 (EXCAVATORS) 3D84E/35001 Hydraulic Oil Filter.....	H-5607
PC300N-3 (EXCAVATORS) S6D125-1/13137 Hydraulic Oil Filter.....	H-7911	PC340LC-6K (EXCAVATORS) SAA6D114E-1/K30001-UP/21212392-UP Hydraulic Oil Filter.....	H-56610	PC360-3 (EXCAVATORS) S/N: 10001 Hydraulic Oil Filter.....	H-7911
Hydraulic Oil Filter.....	H-5652			PC38 (EXCAVATORS) 3TN84E Hydraulic Oil Filter.....	H-5607



ENGINE APPLICATION

MODEL/APPLICATION	SAKURA NO	MODEL/APPLICATION	SAKURA NO	MODEL/APPLICATION	SAKURA NO
KOMATSU		KOMATSU		KOMATSU	
PC340LC-7K (EXCAVATORS) SAA6D114E-2A		Hydraulic Oil Filter.....	H-5609	Hydraulic Oil Filter.....	H-5609
Hydraulic Oil Filter Tank Breather...	H-56610	Hydraulic Oil Filter.....	H-5652	PC400LC-5 (EXCAVATORS) S6D125-1/20001/35323	
Hydraulic Oil Filter.....	H-5629	PC400-5 (EXCAVATORS) S6D125-1/20001/35323		Hydraulic Oil Filter.....	H-5652
PC360-7 (EXCAVATORS) SAA6D114E		Hydraulic Oil Filter.....	H-5652	Hydraulic Oil Filter.....	H-5609
Hydraulic Oil Filter.....	H-5629	Hydraulic Oil Filter.....	H-5609	PC400LC-6 (EXCAVATORS) M11	
PC300-8 (EXCAVATORS) KOMATSU SAA6D114E-3D-WT		PC400-6 (EXCAVATORS) SA6D125E		Hydraulic Oil Filter.....	H-5609
Hydraulic Oil Filter additional part..	H-7105	Hydraulic Oil Filter.....	H-2709	PC400LC-6 (EXCAVATORS) SA6D125E	
PC300-8 (EXCAVATORS) SAA6D114E-3		PC400-6 (EXCAVATORS) SA6D125E-2/30001/60721		Hydraulic Oil Filter.....	H-2709
Hydraulic Oil Filter Tank Breather...	H-56610	Hydraulic Oil Filter Tank Breather...	H-56610	PC400LC-6 (EXCAVATORS) SA6D125E-2/30001/60721	
Hydraulic Oil Filter.....	H-5629	Hydraulic Oil Filter.....	H-2709	Hydraulic Oil Filter Tank Breather...	H-56610
PC300LC-7 (EXCAVATORS) SAA6D114E-2A		PC400-6 (EXCAVATORS) SAA6D125E		Hydraulic Oil Filter.....	H-2709
Hydraulic Oil Filter.....	H-5629	Hydraulic Oil Filter.....	H-2709	PC400LC-6 (EXCAVATORS) SAA6D125E	
PC300LC-7E0 (EXCAVATORS) SAA6D114E-3		PC400-7 (EXCAVATORS)		Hydraulic Oil Filter.....	H-2709
Hydraulic Oil Filter.....	H-5629	Hydraulic Oil Filter.....	H-5639	PC400LC-6MH (EXCAVATORS) SA6D125E	
PC40 (EXCAVATORS) 4TNE84		PC400HD-5 (EXCAVATORS) S6D125-1/35323		Hydraulic Oil Filter.....	H-2709
Hydraulic Oil Filter.....	H-5607	Hydraulic Oil Filter.....	H-5652	PC400LC-6MH (EXCAVATORS) SAA6D125E	
PC400 (EXCAVATORS) S6D125		Hydraulic Oil Filter.....	H-5609	Hydraulic Oil Filter.....	H-2709
Hydraulic Oil Filter.....	H-5609	PC400HD-5 (EXCAVATORS) S6D125-1VW		PC400LC-7 (EXCAVATORS) SAA6D125E	
PC4000 (SHOVELS) CUMMINS KTA38 , 2007		Hydraulic Oil Filter.....	H-5609	Hydraulic Oil Filter.....	H-5639
Hydraulic Oil Filter.....	H-62110	PC400HD-5K (EXCAVATORS) 20001		PC400LC-7E0 (EXCAVATORS) KOMATSU SAA6D125E-5	
PC400-1 (EXCAVATORS) NT-855		Hydraulic Oil Filter.....	H-5609	Hydraulic Oil Filter additional part..	H-7105
Hydraulic Oil Filter.....	H-7911	PC400HD-6 (EXCAVATORS) M11		PC400LC-7MH (EXCAVATORS) SAA6D125E	
PC400-1SER (INDUSTRIAL EQUIPMENTS, ENGINES)		Hydraulic Oil Filter.....	H-5609	Hydraulic Oil Filter.....	H-5639
Hydraulic Oil Filter.....	H-7911	PC400HD-6 (EXCAVATORS) SA6D125E-2		PC400LC-8 (EXCAVATORS) SAA6D125E-5	
PC400-3 (EXCAVATORS) S6D125		Hydraulic Oil Filter.....	H-2709	Hydraulic Oil Filter Tank Breather...	H-56610
Hydraulic Oil Filter.....	H-7911	PC400HD-6LM (EXCAVATORS) SA6D125E-2		PC40-1 (EXCAVATORS) 3D84-1	
PC400-3 (EXCAVATORS) S6D125-1/11001/13444		Hydraulic Oil Filter.....	H-2709	Hydraulic Oil Filter.....	H-5607
Hydraulic Oil Filter.....	H-7911	PC400LC-1 (EXCAVATORS) NT-855		PC40-1 (EXCAVATORS) 3D94-2	
Hydraulic Oil Filter.....	H-5652	Hydraulic Oil Filter.....	H-7911	Hydraulic Oil Filter.....	H-5607
PC400-3 (EXCAVATORS) S6D125-1T/11455/17974		PC400LC-3 (EXCAVATORS) S6D125-1/11001/13444		PC40-2 (EXCAVATORS) 3D84-1	
Hydraulic Oil Filter.....	H-7911	Hydraulic Oil Filter.....	H-7911	Hydraulic Oil Filter.....	H-5607
Hydraulic Oil Filter.....	H-5652	Hydraulic Oil Filter.....	H-5652	PC40-2 (EXCAVATORS) 3D94-2	
PC400-3SER (INDUSTRIAL EQUIPMENTS, ENGINES)		PC400LC-3 (EXCAVATORS) S6D125-1T/11455/17974		Hydraulic Oil Filter.....	H-5607
Hydraulic Oil Filter.....	H-7911	Hydraulic Oil Filter.....	H-7911	PC40-3 (EXCAVATORS) 3D84-1	
Hydraulic Oil Filter.....	H-5652	PC400LC-5 (EXCAVATORS) S6D125-1VW/20001		Hydraulic Oil Filter.....	H-5607
PC400-5 (EXCAVATORS) S6D125-1VW/20001		Hydraulic Oil Filter.....	H-5652		



ENGINE APPLICATION

MODEL/APPLICATION	SAKURA NO	MODEL/APPLICATION	SAKURA NO	MODEL/APPLICATION	SAKURA NO
KOMATSU		KOMATSU		KOMATSU	
PC40-3 (EXCAVATORS) 3D94-2		PC450-7 (EXCAVATORS) 20066 , 2004		PC450LC-7 (EXCAVATORS) KOMATSU , 2005	
Hydraulic Oil Filter.....	H-5607	Hydraulic Oil Filter.....	H-5639	Hydraulic Oil Filter.....	H-5639
PC40-5 (EXCAVATORS) 3D955-W-1/8501/10467/13617		PC450-7 (EXCAVATORS)		Hydraulic Oil Filter Tank Breather..	H-56610
Hydraulic Oil Filter.....	H-5607	Hydraulic Oil Filter Tank Breather..	H-56610	PC50UU-1 (EXCAVATORS) 1001	
PC40-5 (EXCAVATORS) 3D955-W-1/8501/13618		PC450-7K (EXCAVATORS) SAA6D125E-3K		Hydraulic Oil Filter.....	H-5607
Hydraulic Oil Filter.....	H-5607	Hydraulic Oil Filter Tank Breather..	H-56610	PC50UU-2 (EXCAVATORS) 4D84-2GA/12772 - 14992	
PC40-6 (EXCAVATORS) 3D955-W-1C/10001/10467/13617		PC450-8 (EXCAVATORS) SAA6D125E-5F		Hydraulic Oil Filter.....	H-5607
Hydraulic Oil Filter.....	H-5607	Hydraulic Oil Filter Tank Breather..	H-56610	PC50UU-2 (EXCAVATORS) 4D84-2GA/8001 - 12771	
PC40-6 (EXCAVATORS) 3D955-W-1C/10001/13618		PC450LC-6 (EXCAVATORS) SA6D125E-2/10001/60721		Hydraulic Oil Filter.....	H-5607
Hydraulic Oil Filter.....	H-5607	Hydraulic Oil Filter.....	H-5639	PC50UU-2 (EXCAVATORS) 4D88E-3B/14993	
PC40-7 (EXCAVATORS) 4D84E-3/24522		PC450LC-6K (EXCAVATORS) MTA11 , 2012		Hydraulic Oil Filter.....	H-5607
Hydraulic Oil Filter.....	H-5607	Hydraulic Oil Filter Tank Breather..	H-56610	PC50UU-2 (EXCAVATORS) 4D88E-3B/8001 - 12771	
PC40-7 (EXCAVATORS) 4D84-2/18001/24521		PC450LC-6K (EXCAVATORS) SAA6D125E-2C , 2012		Hydraulic Oil Filter.....	H-5607
Hydraulic Oil Filter.....	H-5607	Hydraulic Oil Filter.....	H-2709	PC50UU-2 (EXCAVATORS) 4D84-2	
PC40R-8 (EXCAVATORS) 4D84E-3D/30001		PC45-1 (EXCAVATORS) 4D84-2/1001/3505/1001		Hydraulic Oil Filter.....	H-5607
Hydraulic Oil Filter.....	H-5607	Hydraulic Oil Filter.....	H-5607	PC50UU-2 (EXCAVATORS) 4D88E-3C/12772/14992	
PC410AV (EXCAVATORS) S6D125		PC45-1 (EXCAVATORS) 4D84E-3/3506		Hydraulic Oil Filter.....	H-5607
Hydraulic Oil Filter.....	H-5609	Hydraulic Oil Filter.....	H-5607	PC50UU-2 (EXCAVATORS) 4D88E-3C/12772/14992	
PC45 (EXCAVATORS) 4TNE84		PC45R-8 (EXCAVATORS) 4D84E-3D/5001		Hydraulic Oil Filter.....	H-5607
Hydraulic Oil Filter.....	H-5607	Hydraulic Oil Filter.....	H-5607	PC50UU-2 (EXCAVATORS) 4D88E-3C/14993	
Hydraulic Oil Filter.....	H-5608	PC450LC-7K (EXCAVATORS) SAA6D125E-3K		Hydraulic Oil Filter.....	H-5607
PC450-6 (EXCAVATORS) SAA6D125E-2/10001/60721		Hydraulic Oil Filter Tank Breather..	H-56610	PC50UU-2 (EXCAVATORS) 4D88E-3C/8001/12771	
Hydraulic Oil Filter.....	H-2709	PC450LC-8 (EXCAVATORS) KOMATSU SAA6D125E-5F-02		Hydraulic Oil Filter.....	H-5607
Hydraulic Oil Filter Tank Breather..	H-56610	Hydraulic Oil Filter additional part..	H-7105	PC58UU-3 (EXCAVATORS) 4D88E	
PC450-6K (EXCAVATORS) MTA11 , 2012		PC450LC-8 (EXCAVATORS) SAA6D125E-5F		Hydraulic Oil Filter.....	H-5607
Hydraulic Oil Filter.....	H-2709	Hydraulic Oil Filter.....	H-5639	PC60 (EXCAVATORS) 4D94-2D	
PC450-6K (EXCAVATORS) SAA6D125E-2A , 2012		PC450LCHD-8 (EXCAVATORS) SAA6D125E-5F		Hydraulic Oil Filter.....	H-5607
Hydraulic Oil Filter.....	H-2709	Hydraulic Oil Filter.....	H-5639	PC60 (EXCAVATORS) 4D95L	
PC450-6K (EXCAVATORS) SAA6D125E-2C , 2012		PC400-8 (EXCAVATORS) SAA6D125E-5		Hydraulic Oil Filter.....	H-5607
Hydraulic Oil Filter.....	H-2709	Hydraulic Oil Filter Tank Breather..	H-56610	PC600 (EXCAVATORS) N14 , 2004	
PC450-6K (EXCAVATORS)		PC450-8R (EXCAVATORS) SAA6D125E-5F		Hydraulic Oil Filter.....	H-7911
Hydraulic Oil Filter.....	H-7911	Hydraulic Oil Filter.....	H-5639	PC600-7K (EXCAVATORS) 2006	
PC450-6SER (INDUSTRIAL EQUIPMENTS, ENGINES)					
Hydraulic Oil Filter Tank Breather..	H-56610				
Hydraulic Oil Filter.....	H-2709				



ENGINE APPLICATION

MODEL/APPLICATION	SAKURA NO	MODEL/APPLICATION	SAKURA NO	MODEL/APPLICATION	SAKURA NO
KOMATSU		KOMATSU		KOMATSU	
PC600LC-7MH (EXCAVATORS) SAGD140E-3 , 2004 Hydraulic Oil Filter Tank Breather...	H-56610	Hydraulic Oil Filter.....	H-7911	Hydraulic Oil Filter.....	H-5622
PC70 (EXCAVATORS) 4D95L Hydraulic Oil Filter.....	H-5607	PC750SE-6 (EXCAVATORS) QSK19 Hydraulic Oil Filter.....	H-7911	PC80-1 (EXCAVATORS) w/Komatsu 4D105-5K Eng Hydraulic Oil Filter.....	H-5519
PC710 (EXCAVATORS) SAGD140 Hydraulic Oil Filter.....	H-7911	PC750SE-6 (EXCAVATORS) SAA6D140E/10001 Hydraulic Oil Filter.....	H-7911	PC80-3 (EXCAVATORS) 4D95L-1/2001/15941 Hydraulic Oil Filter.....	H-5607
PC710-5 (EXCAVATORS) SAGD140-1/11019/18624 Hydraulic Oil Filter.....	H-7911	PC750SE-6 (EXCAVATORS) SAA6D140E-2/10001 Hydraulic Oil Filter.....	H-7911	PC80-3-SER (INDUSTRIAL EQUIPMENTS, ENGINES) Hydraulic Oil Filter.....	H-5607
PC710-5SER (INDUSTRIAL EQUIPMENTS, ENGINES) Hydraulic Oil Filter.....	HC-5601	PC750LC-7 (EXCAVATORS) SAA6D140E Hydraulic Oil Filter Tank Breather...	H-56610	PC800-8 (EXCAVATORS) SAA6D140E-5 Hydraulic Oil Filter Tank Breather...	H-56610
PC710SE-5 (EXCAVATORS) SAGD140-1/11019/18624 Hydraulic Oil Filter.....	H-7911	Hydraulic Oil Filter.....	HC-5602	Hydraulic Oil Filter.....	HC-5602
PC75 (EXCAVATORS) 4D95L Hydraulic Oil Filter.....	H-5607	Hydraulic Oil Filter.....	H-5618	PC800-8E0 (EXCAVATORS) SAA6D140E-5 Hydraulic Oil Filter.....	HC-5602
PC7500-1 (EXCAVATORS) Hydraulic Oil Filter.....	H-5607	PC750LC-7MH (EXCAVATORS) SAA6D140E Hydraulic Oil Filter Tank Breather...	H-56610	Hydraulic Oil Filter Tank Breather...	H-56610
PC750-6 (EXCAVATORS) QSK19 Hydraulic Oil Filter.....	H-7911	Hydraulic Oil Filter.....	HC-5602	PC800LC-8 (EXCAVATORS) SAA6D140E-5 Hydraulic Oil Filter.....	HC-5602
Hydraulic Oil Filter.....	H-5652	Hydraulic Oil Filter.....	H-5618	Hydraulic Oil Filter Tank Breather...	H-56610
PC750-6 (EXCAVATORS) SAA6D140E Hydraulic Oil Filter.....	H-7911	PC80 (EXCAVATORS) 4D105 Hydraulic Oil Filter.....	H-5622	PC800-8K (EXCAVATORS) SAA6D140E-5 Hydraulic Oil Filter Tank Breather...	H-56610
PC750LC-6 (EXCAVATORS) QSK19 Hydraulic Oil Filter.....	H-7911	PC80 (EXCAVATORS) 4D95L Hydraulic Oil Filter.....	H-5607	Hydraulic Oil Filter.....	HC-5602
Hydraulic Oil Filter.....	H-5652	PC80 (EXCAVATORS) w/Komatsu 4D105 Eng Hydraulic Oil Filter.....	H-5519	PC800LC-8E0 (EXCAVATORS) SAA6D140E-5 Hydraulic Oil Filter Tank Breather...	H-56610
PC750LC-6 (EXCAVATORS) SAA6D140E Hydraulic Oil Filter.....	H-7911	PC800 (EXCAVATORS) 2006 Hydraulic Oil Filter Tank Breather...	H-56610	Hydraulic Oil Filter.....	HC-5602
PC750LC-6 (EXCAVATORS) SAA6D140E-2 Hydraulic Oil Filter.....	H-7911	Hydraulic Oil Filter.....	HC-5602	Hydraulic Oil Filter Tank Breather...	H-56610
PC750LC-6 (EXCAVATORS) SAA6D140E Hydraulic Oil Filter.....	H-7911	PC800-7 (EXCAVATORS) 2006 Hydraulic Oil Filter Tank Breather...	H-56610	PC90 (EXCAVATORS) 4D95L Hydraulic Oil Filter.....	H-5607
PC750LC-6 (EXCAVATORS) SAA6D140E-2 Hydraulic Oil Filter.....	H-7911	Hydraulic Oil Filter.....	HC-5602	PC90-1 (EXCAVATORS) 4D95L-1/1001/49969 Hydraulic Oil Filter.....	H-5607
PC750LC-6MH (EXCAVATORS) SAA6D140E Hydraulic Oil Filter.....	H-7911	PC800SE-6 (EXCAVATORS) SAA6D140E Hydraulic Oil Filter.....	H-7911	PF55L-1 (EXCAVATORS) S6D105-B-1A/10001/81935 Hydraulic Oil Filter.....	H-5609
PC750LC-6MH (EXCAVATORS) SAA6D140E-2 Hydraulic Oil Filter.....	H-7911	PC800SE-6 (EXCAVATORS) SAA6D140E-2/30001 Hydraulic Oil Filter.....	H-7911	PF-666 (GRADERS) CUMMINS Hydraulic Oil Filter Transmission...	H-65030
		PC800SE-6 (EXCAVATORS) SAA6D140E/30001 Hydraulic Oil Filter.....	H-7911	PF-777 (GRADERS) CUMMINS Hydraulic Oil Filter Transmission...	H-65030



ENGINE APPLICATION

MODEL/APPLICATION	SAKURA NO	MODEL/APPLICATION	SAKURA NO	MODEL/APPLICATION	SAKURA NO
KOMATSU		KOMATSU		KOMATSU	
PW100 (EXCAVATORS) S4D105-5		PW170-5K (EXCAVATORS)		PW210-1 (EXCAVATORS) S6D105-1/10001	
Hydraulic Oil Filter.....	H-5610	Hydraulic Oil Filter.....	H-56600	Hydraulic Oil Filter.....	H-5609
Hydraulic Oil Filter.....	H-56600	Hydraulic Oil Filter.....	H-5610		
PW100-1 (EXCAVATORS) S4D105-5		PW170-5K (EXCAVATORS) 1006-6TD		PW220 (SHOVELS) 2004	
Hydraulic Oil Filter.....	H-5610	Hydraulic Oil Filter.....	H-56600	Hydraulic Oil Filter.....	H-5629
Hydraulic Oil Filter.....	H-56600	Hydraulic Oil Filter.....	H-5610		
PW100-1 (EXCAVATORS) S4D105-5/1003		PW170-5K (EXCAVATORS) 1006-6TLR2		PW200-7H (SHOVELS) H50051 - UP	
Hydraulic Oil Filter.....	H-5610	Hydraulic Oil Filter.....	H-56600	Hydraulic Oil Filter Tank Breather...	H-56610
Hydraulic Oil Filter.....	H-56600	Hydraulic Oil Filter.....	H-5610	Hydraulic Oil Filter.....	H-5629
PW100-3 (EXCAVATORS) S6D95L-1/1601		PW170ES-6K (EXCAVATORS) SAA4D102E		PW220-7K (EXCAVATORS) SAA6D102E-2	
Hydraulic Oil Filter.....	H-56600	Hydraulic Oil Filter.....	H-56600	Hydraulic Oil Filter Tank Breather...	H-56610
Hydraulic Oil Filter.....	H-5610	Hydraulic Oil Filter.....	H-5610	Hydraulic Oil Filter.....	H-5629
PW100-3SER (INDUSTRIAL EQUIPMENTS, ENGINES)		PW118MR-8 (EXCAVATORS) SAA4D95LE-5 , 2011		PW30-1 (EXCAVATORS) 3D84-1/1001	
Hydraulic Oil Filter.....	H-56600	Hydraulic Oil Filter Tank Breather...	H-56610	Hydraulic Oil Filter.....	HC-5602
Hydraulic Oil Filter.....	H-5610	Hydraulic Oil Filter.....	H-56650		
PW130 (SHOVELS) SAD961-1		PW130-7K (EXCAVATORS) SAA4D102E-2		PW60 (EXCAVATORS) 4D94-2	
Hydraulic Oil Filter.....	H-56600	Hydraulic Oil Filter.....	H-56600	Hydraulic Oil Filter.....	H-5607
Hydraulic Oil Filter.....	H-5610				
PW130ES-6 (SHOVELS)		PW140-7 (EXCAVATORS) SAA4D107E-1		PW60-1 (EXCAVATORS) 4D94-2D	
Hydraulic Oil Filter.....	H-56600	Hydraulic Oil Filter Tank Breather...	H-56610	Hydraulic Oil Filter.....	H-5607
Hydraulic Oil Filter.....	H-5610	Hydraulic Oil Filter.....	H-5629		
PW130ES-6K (SHOVELS) S4D102E-1AA/K30545-UP/21273646-UP		PW148-8 (EXCAVATORS) SAA4D107E-1 , 2010		PW60-1 (EXCAVATORS) 4D94-2/1501	
Hydraulic Oil Filter.....	H-56600	Hydraulic Oil Filter Tank Breather...	H-56610	Hydraulic Oil Filter.....	H-5607
Hydraulic Oil Filter.....	H-5610	Hydraulic Oil Filter.....	H-5629		
Hydraulic Oil Filter.....	H-2706	PW150ES-6K (EXCAVATORS) SAA4D102E-2		PW60-1-SER (INDUSTRIAL EQUIPMENTS, ENGINES)	
		Hydraulic Oil Filter.....	H-56600	Hydraulic Oil Filter.....	H-5607
		Hydraulic Oil Filter Tank Breather...	H-56610		
PW150-1 (EXCAVATORS) 6D95L-1/1001		PW160-7 (EXCAVATORS) SAA4D102E-2		PW60-3 (EXCAVATORS) 4D95L-1/2001	
Hydraulic Oil Filter.....	H-5610	Hydraulic Oil Filter.....	H-56600	Hydraulic Oil Filter.....	H-5607
Hydraulic Oil Filter.....	H-56600	Hydraulic Oil Filter Tank Breather...	H-56610		
PW150ES-6 (SHOVELS)		PW180-7 (EXCAVATORS) KOMATSU		PW60N-1 (EXCAVATORS) 4D94-2D	
Hydraulic Oil Filter.....	H-5610	Hydraulic Oil Filter.....	H-5629	Hydraulic Oil Filter.....	H-5607
Hydraulic Oil Filter.....	H-56600				
PW160ES-7 (SHOVELS)		PW200 (SHOVELS) 2004		R2 D1394 (GRADERS) S/N: 30601	
Hydraulic Oil Filter.....	H-5629	Hydraulic Oil Filter.....	H-5629	Hydraulic Oil Filter.....	H-5620
PW170ES-6 (EXCAVATORS) SAA4D102E		PW200-7 (SHOVELS) SAA6D102E-2		S10 (FOREST EQUIPMENTS) DT358	
Hydraulic Oil Filter.....	H-56600	Hydraulic Oil Filter.....	H-5629	Hydraulic Oil Filter.....	H-5403
Hydraulic Oil Filter.....	H-5610				
PW170ES-6 (SHOVELS)		PW20-1 (EXCAVATORS) 3D84-1/1001		S10 (FOREST EQUIPMENTS) DT360	
Hydraulic Oil Filter.....	H-5610	Hydraulic Oil Filter.....	HC-5602	Hydraulic Oil Filter.....	H-5403
Hydraulic Oil Filter.....	H-56600				



ENGINE APPLICATION

MODEL/APPLICATION	SAKURA NO	MODEL/APPLICATION	SAKURA NO	MODEL/APPLICATION	SAKURA NO
KOMATSU		KOMATSU		KOMATSU	
S8A (FOREST EQUIPMENTS) D358		SC40ES (AIR COMPRESSORS)		SE30 (AIR COMPRESSORS)	
Hydraulic Oil Filter.....	H-5403	Hydraulic Oil Filter.....	HC-6217	Hydraulic Oil Filter.....	HC-6802
S8A (FOREST EQUIPMENTS) D360		SC40ES1 (AIR COMPRESSORS)		SE30S (AIR COMPRESSORS)	
Hydraulic Oil Filter.....	H-5403	Hydraulic Oil Filter.....	HC-6217	Hydraulic Oil Filter.....	HC-6802
SC10 (AIR COMPRESSORS)		SC5 (AIR COMPRESSORS) F3L912		SE31S (AIR COMPRESSORS)	
Hydraulic Oil Filter.....	HC-6217	Hydraulic Oil Filter.....	HC-6802	Hydraulic Oil Filter.....	HC-6802
SC10DS (AIR COMPRESSORS) BF6L912		SC50D (AIR COMPRESSORS)		SE40S (AIR COMPRESSORS)	
Hydraulic Oil Filter.....	HC-6802	Hydraulic Oil Filter.....	HC-6802	Hydraulic Oil Filter.....	HC-6802
SC14 (AIR COMPRESSORS) F6L413		SC50DS1 (AIR COMPRESSORS) F3L912		SE41S (AIR COMPRESSORS)	
Hydraulic Oil Filter.....	HC-6802	Hydraulic Oil Filter.....	HC-6802	Hydraulic Oil Filter.....	HC-6802
SC14 (AIR COMPRESSORS)		SC50DS2B (AIR COMPRESSORS) F4L1011		SE50S (AIR COMPRESSORS)	
Hydraulic Oil Filter.....	HC-6217	Hydraulic Oil Filter.....	HC-6802	Hydraulic Oil Filter.....	HC-6802
SC14D (AIR COMPRESSORS) F6L413		SC70D (AIR COMPRESSORS)		SE51S (AIR COMPRESSORS)	
Hydraulic Oil Filter.....	HC-6802	Hydraulic Oil Filter.....	HC-6802	Hydraulic Oil Filter.....	HC-6802
SC17DS (AIR COMPRESSORS) F6L413		SC70DW (AIR COMPRESSORS)		SE60S (AIR COMPRESSORS)	
Hydraulic Oil Filter.....	HC-6217	Hydraulic Oil Filter.....	HC-6802	Hydraulic Oil Filter.....	HC-6802
SC20 (AIR COMPRESSORS) F6L413		SE10S (AIR COMPRESSORS)		SK09J (LOADERS)	
Hydraulic Oil Filter.....	HC-6802	Hydraulic Oil Filter.....	HC-6802	Hydraulic Oil Filter.....	HC-7906
SC20DS (AIR COMPRESSORS) DEUTZ		SE11P TO 26P (AIR COMPRESSORS)		SK714 (LOADERS)	
Hydraulic Oil Filter.....	HC-6801	Hydraulic Oil Filter.....	HC-6802	Hydraulic Oil Filter.....	HC-5507
SC3 (AIR COMPRESSORS) F2L912		SE11S (AIR COMPRESSORS)		Hydraulic Oil Filter.....	HC-55220
Hydraulic Oil Filter.....	HC-6802	Hydraulic Oil Filter.....	HC-6802	SK815 (LOADERS)	
SC30ES (AIR COMPRESSORS)		SE15S (AIR COMPRESSORS)		Hydraulic Oil Filter.....	HC-55220
Hydraulic Oil Filter.....	HC-6217	Hydraulic Oil Filter.....	HC-6802	Hydraulic Oil Filter.....	HC-5507
SC30ES-1 (AIR COMPRESSORS)		SE16S (AIR COMPRESSORS)		SK818-5 (LOADERS) KOMATSU , 2004	
Hydraulic Oil Filter.....	HC-6217	Hydraulic Oil Filter.....	HC-6802	Hydraulic Oil Filter.....	HC-5507
SC3535F (AIR COMPRESSORS) F3L912		SE20 (AIR COMPRESSORS)		Hydraulic Oil Filter.....	HC-55220
Hydraulic Oil Filter.....	HC-6802	Hydraulic Oil Filter.....	HC-6802	T-180F (LOADERS)	
SC38DS (AIR COMPRESSORS) F2L912		SE20S (AIR COMPRESSORS)		Hydraulic Oil Filter.....	H-5405
Hydraulic Oil Filter.....	HC-6802	Hydraulic Oil Filter.....	HC-6802	T-400 SERIES A (GRADERS) D407A	
SC3DS (AIR COMPRESSORS) F2L912		SE21S (AIR COMPRESSORS)		Hydraulic Oil Filter Transmission...	H-65030
Hydraulic Oil Filter.....	HC-6802	Hydraulic Oil Filter.....	HC-6802	T-500 (GRADERS) 4-71	
SC40DS (AIR COMPRESSORS) DEUTZ		SE26S (AIR COMPRESSORS)		Hydraulic Oil Filter Transmission...	H-65030
Hydraulic Oil Filter.....	HC-6217	Hydraulic Oil Filter.....	HC-6802	T-500 SERIES A (GRADERS) 4-71	
				Hydraulic Oil Filter Transmission...	H-65030



ENGINE APPLICATION

MODEL/APPLICATION	SAKURA NO	MODEL/APPLICATION	SAKURA NO	MODEL/APPLICATION	SAKURA NO
KOMATSU		KOMATSU		KOMATSU	
T-700 (GRADERS) CUMMINS		W120-2 (LOADERS) SA6D110		W70-1 (LOADERS) 6D105	
Hydraulic Oil Filter Transmission...	H-65030	Hydraulic Oil Filter.....	H-5618	Hydraulic Oil Filter.....	H-5618
		Hydraulic Oil Filter.....	H-5609	Hydraulic Oil Filter.....	H-5609
T-800 (CONSTRUCTION EQUIPMENTS) DIESEL		W120-3 (LOADERS) SA6D110		W70-2 (LOADERS) 6B155	
Hydraulic Oil Filter Transmission...	H-65030	Hydraulic Oil Filter.....	H-5609	Hydraulic Oil Filter.....	H-5618
		Hydraulic Oil Filter.....	H-5618	Hydraulic Oil Filter.....	H-5609
T-800 (CONSTRUCTION EQUIPMENTS) GAS		W180-1 (LOADERS) NT-855		W70-2 (LOADERS) 6D105	
Hydraulic Oil Filter.....	H-5405	Hydraulic Oil Filter.....	H-5618	Hydraulic Oil Filter.....	H-5609
Hydraulic Oil Filter Transmission...	H-65030	Hydraulic Oil Filter.....	H-5609	Hydraulic Oil Filter.....	H-5618
TD12 (DOZERS) D466B		W260-1 (LOADERS) KT-1150		W90-2 (LOADERS) S6D105-1	
Hydraulic Oil Filter.....	H-5403	Hydraulic Oil Filter.....	H-5609	Hydraulic Oil Filter.....	H-5618
		Hydraulic Oil Filter.....	H-5618	Hydraulic Oil Filter.....	H-5609
TD12C (DOZERS)		W40-1 (LOADERS) 4D105-3		W90-3 (LOADERS) S6D105-1	
Hydraulic Oil Filter.....	H-5403	Hydraulic Oil Filter.....	H-5618	Hydraulic Oil Filter.....	H-5609
		Hydraulic Oil Filter.....	H-5618	Hydraulic Oil Filter.....	H-5618
TD15B (DOZERS) DT361		W40-1 (LOADERS) 4D92		WA100-1 (LOADERS) 6D95L-1/10001	
Hydraulic Oil Filter.....	H-5405	Hydraulic Oil Filter.....	H-5618	Hydraulic Oil Filter.....	H-5618
		Hydraulic Oil Filter.....	H-5618	Hydraulic Oil Filter.....	H-5607
TD15E (DOZERS) DT466C		W40-2 (LOADERS) 4D92		Hydraulic Oil Filter.....	H-5652
Hydraulic Oil Filter.....	H-5403	Hydraulic Oil Filter.....	H-5618	Hydraulic Oil Filter.....	H-5618
		Hydraulic Oil Filter.....	H-5618	Hydraulic Oil Filter.....	H-5618
TD20E (DOZERS) V-800		W60 (LOADERS) 6B155		WA1200-3 (LOADERS) QSK60	
Hydraulic Oil Filter.....	H-5403	Hydraulic Oil Filter.....	H-5618	Hydraulic Oil Filter.....	H-7911
		Hydraulic Oil Filter.....	H-5618	Hydraulic Oil Filter.....	H-5652
TD20G (DOZERS) CUMMINS		W60-1 (LOADERS) 6B155		Hydraulic Oil Filter.....	H-2709
Hydraulic Oil Filter.....	H-5403	Hydraulic Oil Filter.....	H-5618	Hydraulic Oil Filter.....	H-5618
		Hydraulic Oil Filter.....	H-5609	Hydraulic Oil Filter.....	H-5607
TD25B (DOZERS) DT817		W60-1 (LOADERS) 6D105		WA120-1 (LOADERS) 6D95L-1/10001	
Hydraulic Oil Filter Transmission...	H-65030	Hydraulic Oil Filter.....	H-5609	Hydraulic Oil Filter.....	H-5618
		Hydraulic Oil Filter.....	H-5618	Hydraulic Oil Filter.....	H-5607
TD25E (DOZERS) DT817C		W70 (LOADERS) 6B155		WA120-2L (LOADERS) A30001	
Hydraulic Oil Filter.....	H-5406	Hydraulic Oil Filter.....	H-5618	Hydraulic Oil Filter.....	H-5618
Hydraulic Oil Filter Transmission...	H-65030	Hydraulic Oil Filter.....	H-5609	Hydraulic Oil Filter.....	H-5607
TD25G (DOZERS) KT-1150		W60-1 (LOADERS) 6D105		WA120-3 (LOADERS) 6D95L-1/50001 - 52999	
Hydraulic Oil Filter.....	H-5403	Hydraulic Oil Filter.....	H-5609	Hydraulic Oil Filter.....	H-5607
		Hydraulic Oil Filter.....	H-5618	Hydraulic Oil Filter.....	H-5618
TD30 (DOZERS)		W70 (LOADERS) 6B155		WA120-3 (LOADERS) 6D95L-1/ALL	
Hydraulic Oil Filter Transmission...	H-65030	Hydraulic Oil Filter.....	H-5609	Hydraulic Oil Filter.....	H-5607
		Hydraulic Oil Filter.....	H-5618	Hydraulic Oil Filter.....	H-5618
TD40 (DOZERS) KTA-1150		W70 (LOADERS) 6D105		WA120-3 (LOADERS)	
Hydraulic Oil Filter.....	H-5403	Hydraulic Oil Filter.....	H-5618	Hydraulic Oil Filter.....	H-5618
		Hydraulic Oil Filter.....	H-5609	Hydraulic Oil Filter.....	H-5618
VZ130 (AIR COMPRESSORS)		W70-1 (LOADERS) 6B155		WA120-LC (LOADERS)	
Hydraulic Oil Filter.....	HC-6217	Hydraulic Oil Filter.....	H-5618	Hydraulic Oil Filter.....	H-5607
		Hydraulic Oil Filter.....	H-5609	Hydraulic Oil Filter.....	H-5618
W120-1 (LOADERS) PD6T				Hydraulic Oil Filter.....	H-5618
Hydraulic Oil Filter.....	H-5618			Hydraulic Oil Filter.....	H-5607
				Hydraulic Oil Filter.....	H-5618



ENGINE APPLICATION

MODEL/APPLICATION	SAKURA NO	MODEL/APPLICATION	SAKURA NO	MODEL/APPLICATION	SAKURA NO
KOMATSU		KOMATSU		KOMATSU	
WA120-LC (LOADERS)		Hydraulic Oil Filter.....	H-5618	Hydraulic Oil Filter.....	H-5652
Hydraulic Oil Filter.....	H-5618	Hydraulic Oil Filter.....	H-5652	Hydraulic Oil Filter.....	H-5609
WA150-1 (LOADERS) S6D95L-1/10001		WA250 (LOADERS) 6B5.9		Hydraulic Oil Filter.....	H-5610
Hydraulic Oil Filter.....	H-5618	Hydraulic Oil Filter.....	H-5607	Hydraulic Oil Filter.....	H-56600
Hydraulic Oil Filter.....	H-5607	WA250-1 (LOADERS) CUMMINS		WA320-1 (LOADERS) S6D105-1/94068	
Hydraulic Oil Filter.....	H-5652	Hydraulic Oil Filter.....	H-5618	Hydraulic Oil Filter.....	H-5618
WA180-1 (LOADERS) S6D95L-1/26330		Hydraulic Oil Filter.....	H-5607	Hydraulic Oil Filter.....	H-5609
Hydraulic Oil Filter.....	H-5618	WA250-1 (LOADERS) S6D105-1/10001		Hydraulic Oil Filter.....	H-5652
Hydraulic Oil Filter.....	H-5607	Hydraulic Oil Filter.....	H-5607	WA320-1 (LOADERS) S6D105-1/86535/94067	
WA180-1LC (LOADERS)		Hydraulic Oil Filter.....	H-5652	Hydraulic Oil Filter.....	H-56600
Hydraulic Oil Filter.....	H-5618	WA250-1 (LOADERS) S6D105-1/86423		Hydraulic Oil Filter.....	H-5610
Hydraulic Oil Filter.....	H-5607	Hydraulic Oil Filter.....	H-5607	Hydraulic Oil Filter.....	H-5618
WA180-3 (LOADERS) S6D102E		Hydraulic Oil Filter.....	H-5618	WA320-1LC (LOADERS)	
Hydraulic Oil Filter.....	H-5607	WA250-1 (LOADERS) S6D105-1/50001		Hydraulic Oil Filter.....	H-5618
WA180-3 (LOADERS) S6D102E/53001		Hydraulic Oil Filter.....	H-5618	Hydraulic Oil Filter.....	H-5607
Hydraulic Oil Filter.....	H-5607	WA250-3 (LOADERS) S6D95L-1/50001		Hydraulic Oil Filter.....	H-5652
Hydraulic Oil Filter.....	H-5618	Hydraulic Oil Filter.....	H-5607	WA320-3 (LOADERS) S6D108-1/50001 - 52999	
Hydraulic Oil Filter.....	H-5607	WA250-3 (LOADERS) S6D95L-1/13714		Hydraulic Oil Filter.....	H-5652
WA180-3 (LOADERS) S6D95L-1/50001/52999		Hydraulic Oil Filter.....	H-5618	Hydraulic Oil Filter.....	H-5618
Hydraulic Oil Filter.....	H-5618	Hydraulic Oil Filter.....	H-5607	Hydraulic Oil Filter.....	H-5609
Hydraulic Oil Filter.....	H-5607	WA250-3L (LOADERS) A87000		WA320-3 (LOADERS) S6D108-1G/53001	
WA180-3D (LOADERS) S6D102E		Hydraulic Oil Filter.....	H-5607	Hydraulic Oil Filter.....	H-5618
Hydraulic Oil Filter.....	H-5618	WA270 (LOADERS) S/N: N270H20907		Hydraulic Oil Filter.....	H-5652
Hydraulic Oil Filter.....	H-5607	Hydraulic Oil Filter Transmission... HC-2701	HC-2701	Hydraulic Oil Filter.....	H-5609
WA180-3D (LOADERS) S6D102E-1W/53001		WA270-3 (LOADERS) S6D102E		WA320-3 (LOADERS) S6D114E	
Hydraulic Oil Filter.....	H-5607	Hydraulic Oil Filter Transmission... HC-2701	HC-2701	Hydraulic Oil Filter.....	H-5618
Hydraulic Oil Filter.....	H-5618	WA270-30 (LOADERS)		Hydraulic Oil Filter.....	H-5609
WA180-3L (LOADERS) S/N: A80001		Hydraulic Oil Filter Transmission.. HC-76130	HC-76130	WA320-3CS (LOADERS) SA6D102E-1B/50001	
Hydraulic Oil Filter.....	H-5618	WA320-3H (LOADERS)		Hydraulic Oil Filter.....	H-5618
Hydraulic Oil Filter.....	H-5607	Hydraulic Oil Filter.....	H-5618	Hydraulic Oil Filter.....	H-5652
WA180PT-3 (LOADERS) S6D102E		WA300-1 (LOADERS) S6D105-1/10001		Hydraulic Oil Filter.....	H-5609
Hydraulic Oil Filter.....	H-5618	Hydraulic Oil Filter.....	H-5610	WA320-3LE (LOADERS) S6D114E-1/A30001	
Hydraulic Oil Filter.....	H-5607	Hydraulic Oil Filter.....	H-5618	Hydraulic Oil Filter.....	H-5609
WA1200-6 (LOADERS) SAADA16V160E-2 , 2011		Hydraulic Oil Filter.....	H-5652	Hydraulic Oil Filter.....	H-5618
Hydraulic Oil Filter.....	H-7911	Hydraulic Oil Filter.....	H-56600	WA350-1 (LOADERS) S6D110-1/10001	
Hydraulic Oil Filter.....	H-2709	WA300-3L (LOADERS) S/N: A53001		Hydraulic Oil Filter.....	H-5618
Hydraulic Oil Filter.....	H-5652	Hydraulic Oil Filter.....	H-5652	Hydraulic Oil Filter.....	H-5609
WA200-1 (LOADERS) 6D105-1/10001		Hydraulic Oil Filter.....	H-5609	WA350-1 (LOADERS) S/N: 10001	
Hydraulic Oil Filter.....	H-5607	WA320-1 (LOADERS) S6D105-1/10001		Hydraulic Oil Filter.....	H-5609
		Hydraulic Oil Filter.....	H-5609	Hydraulic Oil Filter.....	H-5618
		WA320-1 (LOADERS) S6D105-1/10001		WA380-1 (LOADERS) SA6D110-1/10001	
		Hydraulic Oil Filter.....	H-5652	Hydraulic Oil Filter.....	H-5652
			H-5618	Hydraulic Oil Filter.....	H-5618



ENGINE APPLICATION

MODEL/APPLICATION	SAKURA NO	MODEL/APPLICATION	SAKURA NO	MODEL/APPLICATION	SAKURA NO
KOMATSU		KOMATSU		KOMATSU	
WA380-1 (LOADERS) SA6D110-1/10001		WA380-3MC (LOADERS) A51001		Hydraulic Oil Filter.....	H-5618
Hydraulic Oil Filter.....	H-5609	Hydraulic Oil Filter.....	H-5609	WA420-3 (LOADERS) SA6D108	
WA380-1 (LOADERS) SA6D110-1/55205/56993		Hydraulic Oil Filter.....	H-5618	Hydraulic Oil Filter.....	H-5618
Hydraulic Oil Filter.....	H-5652	WA380-5 (LOADERS) 2003		Hydraulic Oil Filter.....	H-5609
Hydraulic Oil Filter.....	H-5618	Hydraulic Oil Filter.....	H-7911	Hydraulic Oil Filter.....	H-5652
Hydraulic Oil Filter.....	H-5609	WA380-6 (LOADERS) 2006		WA420-3 (LOADERS) SA6D108-1/50001/52999	
WA380-1 (LOADERS) SA6D110-1/54352/55205		Hydraulic Oil Filter.....	H-56650	Hydraulic Oil Filter.....	H-5618
Hydraulic Oil Filter.....	H-5652	WA380H (LOADERS)		Hydraulic Oil Filter.....	H-5652
Hydraulic Oil Filter.....	H-5618	Hydraulic Oil Filter.....	H-5618	Hydraulic Oil Filter.....	H-5609
Hydraulic Oil Filter.....	H-5609	WA400-1 (LOADERS) SA6D110-1/10001		WA420-3 (LOADERS) SA6D108-1/53001	
WA380-1 (LOADERS) SA6D110-1/56994		Hydraulic Oil Filter.....	H-5652	Hydraulic Oil Filter.....	H-5618
Hydraulic Oil Filter.....	H-5618	Hydraulic Oil Filter.....	H-5618	Hydraulic Oil Filter.....	H-5609
Hydraulic Oil Filter.....	H-5652	Hydraulic Oil Filter.....	H-5609	WA420-3 (LOADERS) SAA6D114E-1/19467	
Hydraulic Oil Filter.....	H-5609	WA400-5 (LOADERS) SAA6D114E		Hydraulic Oil Filter.....	H-5652
WA380-1LC (LOADERS) 614T		Hydraulic Oil Filter.....	H-7911	Hydraulic Oil Filter.....	H-5618
Hydraulic Oil Filter.....	H-5618	WA400-5L (LOADERS) SAA6D114E		Hydraulic Oil Filter.....	H-5609
Hydraulic Oil Filter.....	H-5609	Hydraulic Oil Filter.....	H-7911	Hydraulic Oil Filter.....	H-5618
WA380-1LC (LOADERS)		WA400-5WH (LOADERS) SAA6D114E		WA420-3 (LOADERS) SAA6D114E-1	
Hydraulic Oil Filter.....	H-5652	Hydraulic Oil Filter.....	H-7911	Hydraulic Oil Filter.....	H-5609
Hydraulic Oil Filter.....	H-5618	WA400-1 (LOADERS) 1001		Hydraulic Oil Filter.....	H-5618
Hydraulic Oil Filter.....	H-5609	Hydraulic Oil Filter.....	HC-5602	WA420-3CS (LOADERS) WA6D114-1AA/R50001	
WA380-3 (LOADERS) S6D108-1/20188		WA400-1 (LOADERS) 1001		Hydraulic Oil Filter.....	H-5618
Hydraulic Oil Filter.....	H-5652	Hydraulic Oil Filter.....	HC-5602	Hydraulic Oil Filter.....	H-5609
Hydraulic Oil Filter.....	H-5618	WA420-1 (LOADERS) 614T		Hydraulic Oil Filter.....	H-5652
Hydraulic Oil Filter.....	H-5609	Hydraulic Oil Filter.....	H-5609	WA420-3H (LOADERS)	
WA380-3 (LOADERS) S6D108-1/50001 - 52999		Hydraulic Oil Filter.....	H-5618	Hydraulic Oil Filter.....	H-5618
Hydraulic Oil Filter.....	H-5652	Hydraulic Oil Filter.....	H-5618	WA420-3LE (LOADERS) A30001	
Hydraulic Oil Filter.....	H-5618	WA420-1 (LOADERS) SA6D110-1/54110/56996		Hydraulic Oil Filter.....	H-5609
Hydraulic Oil Filter.....	H-5609	Hydraulic Oil Filter.....	H-5609	Hydraulic Oil Filter.....	H-5618
WA380-3 (LOADERS) S6D108-1/53001		Hydraulic Oil Filter.....	H-5652	WA450-1 (LOADERS) S6D125-1/10001	
Hydraulic Oil Filter.....	H-5609	WA420-1 (LOADERS) SA6D110-1/56997		Hydraulic Oil Filter.....	H-5618
Hydraulic Oil Filter.....	H-5652	Hydraulic Oil Filter.....	H-5609	Hydraulic Oil Filter.....	H-5609
Hydraulic Oil Filter.....	H-5618	Hydraulic Oil Filter.....	H-5618	Hydraulic Oil Filter.....	H-5652
WA380-3H (LOADERS)		WA420-1LC (LOADERS)		WA450-1 (LOADERS) S6D125-1/11574	
Hydraulic Oil Filter.....	H-5618	Hydraulic Oil Filter.....	H-5609	Hydraulic Oil Filter.....	H-5652
WA380-3LCE (LOADERS) A50001		Hydraulic Oil Filter.....	H-5618	Hydraulic Oil Filter.....	H-5609
Hydraulic Oil Filter.....	H-5609	Hydraulic Oil Filter.....	H-5652	Hydraulic Oil Filter.....	H-5618
WA380-3LE (LOADERS) S6D114E-1/A50001		Hydraulic Oil Filter.....	H-5652	WA450-2 (LOADERS) LTA10/A25001	
Hydraulic Oil Filter.....	H-5609	WA420-3 (LOADERS) A31001		Hydraulic Oil Filter.....	H-5609
Hydraulic Oil Filter.....	H-5618	Hydraulic Oil Filter.....	H-5609	Hydraulic Oil Filter.....	H-5618
		Hydraulic Oil Filter.....	H-5609	WA450-3 (LOADERS) LTA10	



ENGINE APPLICATION

MODEL/APPLICATION	SAKURA NO	MODEL/APPLICATION	SAKURA NO	MODEL/APPLICATION	SAKURA NO
KOMATSU		KOMATSU		KOMATSU	
WA450-3 (LOADERS) LTA10		WA470-3 (LOADERS) S6D125-1AM/50001 - 52999		WA500-1 (LOADERS) S6D140-1/10001	
Hydraulic Oil Filter.....	H-5652	Hydraulic Oil Filter.....	H-5609	Hydraulic Oil Filter.....	H-5609
Hydraulic Oil Filter.....	H-5609	Hydraulic Oil Filter.....	H-5618	Hydraulic Oil Filter.....	H-5618
Hydraulic Oil Filter.....	H-5618	Hydraulic Oil Filter.....	H-5652	Hydraulic Oil Filter.....	H-5652
WA450-3 (LOADERS) MTA11		WA470-3 (LOADERS) S6D125-1AM/53001		WA500-1 (LOADERS) S6D140-1A/10001 - 19999	
Hydraulic Oil Filter.....	H-5618	Hydraulic Oil Filter.....	H-5609	Hydraulic Oil Filter.....	H-5618
Hydraulic Oil Filter.....	H-5609	Hydraulic Oil Filter.....	H-5652	Hydraulic Oil Filter.....	H-5652
WA450-3LE (LOADERS) A30001		WA470-3H (LOADERS) M11		WA500-1 (LOADERS) S6D140-1R/10001 - 19999	
Hydraulic Oil Filter.....	H-5609	Hydraulic Oil Filter.....	H-5652	Hydraulic Oil Filter.....	H-5652
Hydraulic Oil Filter.....	H-5618	Hydraulic Oil Filter.....	H-5618	Hydraulic Oil Filter.....	H-5609
WA450-3LL (LOADERS) S6D125-1/50305		WA470-3H (LOADERS)		WA500-1 (LOADERS) S6D140-1A/20001	
Hydraulic Oil Filter.....	H-5609	Hydraulic Oil Filter.....	H-5618	Hydraulic Oil Filter.....	H-5618
Hydraulic Oil Filter.....	H-5618	Hydraulic Oil Filter.....	H-5609	Hydraulic Oil Filter.....	H-5609
Hydraulic Oil Filter.....	H-5652	WA470-5 (LOADERS) SAA6D125E-3 , 2001		WA500-1 (LOADERS) S6D140-1R/20001	
WA450-3LL (LOADERS) S6D125-1/53001		Hydraulic Oil Filter.....	H-2709	Hydraulic Oil Filter.....	H-5618
Hydraulic Oil Filter.....	H-5652	WA470-5H (LOADERS)		Hydraulic Oil Filter.....	H-5652
Hydraulic Oil Filter.....	H-5618	Hydraulic Oil Filter.....	H-2709	Hydraulic Oil Filter.....	H-5609
Hydraulic Oil Filter.....	H-5609	WA450-5 (LOADERS) SAA6D125E-3		WA500-11C (LOADERS) A60001	
WA450L-3 (LOADERS) SA6D125E		Hydraulic Oil Filter.....	H-2709	Hydraulic Oil Filter.....	H-5652
Hydraulic Oil Filter.....	H-5618	WA470-6 (LOADERS) SAA6D125E-5 , 2008		Hydraulic Oil Filter.....	H-5618
Hydraulic Oil Filter.....	H-5609	Hydraulic Oil Filter.....	H-5629	Hydraulic Oil Filter.....	H-5609
WA470-1 (LOADERS) S6D125-1KK/20001		WA430-6 (LOADERS) SAA6D114E-3 , 2007		WA500-11E (LOADERS) S/N: A61001	
Hydraulic Oil Filter.....	H-5609	Hydraulic Oil Filter.....	H-56650	Hydraulic Oil Filter.....	H-5618
Hydraulic Oil Filter.....	H-5652	WA450-5L (LOADERS) SAA6D125E-3		Hydraulic Oil Filter.....	H-5609
Hydraulic Oil Filter.....	H-5618	Hydraulic Oil Filter.....	H-2709	WA500-3 (LOADERS)	
WA470-1 (LOADERS) S6D125-1KK/10001/19999		WA450-5WH (LOADERS) SAA6D125E-3		Hydraulic Oil Filter.....	H-2709
Hydraulic Oil Filter.....	H-5652	Hydraulic Oil Filter.....	H-2709	Hydraulic Oil Filter.....	H-5618
Hydraulic Oil Filter.....	H-5609	WA480-6 (LOADERS) SAA6D125E-5 , 2008		WA500-3 (LOADERS) S6D140-1	
Hydraulic Oil Filter.....	H-5618	Hydraulic Oil Filter.....	H-5629	Hydraulic Oil Filter.....	H-5618
WA470-1 (LOADERS) S6D125-1Z/10001/19999		WA500 (LOADERS)		Hydraulic Oil Filter.....	H-2709
Hydraulic Oil Filter.....	H-5609	Hydraulic Oil Filter.....	H-5652	WA500-3 (WHEEL LOADERS) KOMATSU SAD140E	
Hydraulic Oil Filter.....	H-5652	Hydraulic Oil Filter.....	H-5618	Hydraulic Oil Filter.....	H-56740
Hydraulic Oil Filter.....	H-5618	Hydraulic Oil Filter.....	H-5609	WA500-3LE (LOADERS) S/N: A70001	
WA470-1 (LOADERS) S6D125-1Z/20001		WA500-1 (LOADERS) NTA855-C		Hydraulic Oil Filter.....	H-5618
Hydraulic Oil Filter.....	H-5609	Hydraulic Oil Filter.....	H-5618	WA500-3LE (LOADERS) S/N: A70001	
Hydraulic Oil Filter.....	H-5618	Hydraulic Oil Filter.....	H-5609	Hydraulic Oil Filter.....	H-5618
Hydraulic Oil Filter.....	H-5652	WA500-1 (LOADERS) NTA855-C			
WA470-3 (LOADERS) S6D125-1		Hydraulic Oil Filter.....	H-5618		
Hydraulic Oil Filter.....	H-5609	Hydraulic Oil Filter.....	H-5609		
Hydraulic Oil Filter.....	H-5618				
Hydraulic Oil Filter.....	H-5652				



ENGINE APPLICATION

MODEL/APPLICATION	SAKURA NO	MODEL/APPLICATION	SAKURA NO	MODEL/APPLICATION	SAKURA NO
KOMATSU		KOMATSU		KOMATSU	
WA500-3LE (LOADERS) S/N: A70001 Hydraulic Oil Filter.....	H-5609	WA600-3L (LOADERS) S/N: A52001 Hydraulic Oil Filter.....	H-5652	Hydraulic Oil Filter.....	H-5652
WA500-7 (LOADERS) SAA6D140E-6 , 2012 Hydraulic Oil Filter.....	H-5652	WA600-6 (LOADERS) SAA6D170E-5/TIER3 Hydraulic Oil Filter.....	H-5609	Hydraulic Oil Filter.....	H-5609
WA600 (LOADERS) SA6D170E Hydraulic Oil Filter.....	H-5618	WA600-6 (LOADERS) SAA6D170E-5/TIER3 Hydraulic Oil Filter.....	H-5652	Hydraulic Oil Filter.....	H-5652
WA600-1 (LOADERS) QSK19 Hydraulic Oil Filter.....	H-5609	WA700-1 (LOADERS) SA6D170 Hydraulic Oil Filter.....	H-5618	WA800-2 (LOADERS) SA12V140-1/10449 Hydraulic Oil Filter.....	H-5618
Hydraulic Oil Filter.....	H-5609	Hydraulic Oil Filter.....	H-5652	Hydraulic Oil Filter.....	H-5618
WA600-1 (LOADERS) S6D170-1/10001 Hydraulic Oil Filter.....	H-5618	WA700-1 (LOADERS) SA6D170-1/10001 Hydraulic Oil Filter.....	H-5618	Hydraulic Oil Filter.....	H-5652
Hydraulic Oil Filter.....	H-5652	Hydraulic Oil Filter.....	H-5609	Hydraulic Oil Filter.....	H-5609
WA600-1 (LOADERS) S6D170-1D/10001 Hydraulic Oil Filter.....	H-5618	WA700-1 (LOADERS) SA6D170-1/13144 Hydraulic Oil Filter.....	H-5618	Hydraulic Oil Filter.....	H-5609
Hydraulic Oil Filter.....	H-5609	Hydraulic Oil Filter.....	H-5609	Hydraulic Oil Filter.....	H-5618
Hydraulic Oil Filter.....	H-5609	WA700-1 (LOADERS) SA6D170-A-1Q/10001 Hydraulic Oil Filter.....	H-5652	Hydraulic Oil Filter.....	H-5652
WA600-1 (LOADERS) S6D170-1/10490 Hydraulic Oil Filter.....	H-5618	Hydraulic Oil Filter.....	H-5609	WA800-3 (LOADERS) SA12V140 Hydraulic Oil Filter.....	H-5618
Hydraulic Oil Filter.....	H-5652	Hydraulic Oil Filter.....	H-5618	Hydraulic Oil Filter.....	H-5618
Hydraulic Oil Filter.....	H-5618	WA700-1 (LOADERS) SA6D170-A-1Q/10001 Hydraulic Oil Filter.....	H-5652	Hydraulic Oil Filter.....	H-5652
WA600-1LC (LOADERS) Hydraulic Oil Filter.....	H-5609	Hydraulic Oil Filter.....	H-5618	WA800-3E0 (LOADERS) SAA12V140E-3 Hydraulic Oil Filter.....	H-5652
Hydraulic Oil Filter.....	H-5652	WA700-3 (LOADERS) 2007 Hydraulic Oil Filter.....	H-5618	Hydraulic Oil Filter.....	H-5652
Hydraulic Oil Filter.....	H-5618	Hydraulic Oil Filter.....	H-2709	WA900-3 (LOADERS) SAA12V140 Hydraulic Oil Filter.....	H-5618
WA600-1LE (LOADERS) A51001 Hydraulic Oil Filter.....	H-5609	WA70-1 (LOADERS) 4D95L-W-1/10001 Hydraulic Oil Filter.....	H-5652	Hydraulic Oil Filter.....	H-5652
Hydraulic Oil Filter.....	H-5652	Hydraulic Oil Filter.....	H-5618	WA900-1 (LOADERS) SA12V140-1P/50001 Hydraulic Oil Filter.....	H-5609
WA600-3 (LOADERS) S6D170-1 Hydraulic Oil Filter.....	H-5618	WA800-1 (LOADERS) SABV170-1C/10001 Hydraulic Oil Filter.....	H-5609	Hydraulic Oil Filter.....	H-5618
Hydraulic Oil Filter.....	H-5618	Hydraulic Oil Filter.....	H-5618	Hydraulic Oil Filter.....	H-5652
WA600-3 (LOADERS) S6D170E Hydraulic Oil Filter.....	H-5618	WA800-1 (LOADERS) SABV170-1/10040 Hydraulic Oil Filter.....	H-5652	Hydraulic Oil Filter.....	H-5609
Hydraulic Oil Filter.....	H-5618	Hydraulic Oil Filter.....	H-5609	Hydraulic Oil Filter.....	H-5652
WA600-3 (LOADERS) S6D170E-2C/50001 Hydraulic Oil Filter.....	H-5618	WA800-2 (LOADERS) SA12V140-1/10002/10394 Hydraulic Oil Filter.....	H-5618	Hydraulic Oil Filter.....	H-5652
Hydraulic Oil Filter.....	H-5652	Hydraulic Oil Filter.....	H-5609	Hydraulic Oil Filter.....	H-5609
WA6003A (LOADERS) Hydraulic Oil Filter.....	H-5652	Hydraulic Oil Filter.....	H-5652	WA900-3E0 (LOADERS) SAA12V140E-3 Hydraulic Oil Filter.....	H-5652
WA600-3L (LOADERS) QSK19/A52001 Hydraulic Oil Filter.....	H-5618	WA800-2 (LOADERS) SA12V140-1/10394/10448 Hydraulic Oil Filter.....	H-5618	Hydraulic Oil Filter.....	H-5652
Hydraulic Oil Filter.....	H-5618	Hydraulic Oil Filter.....	H-5618	WB140-2 (BACKHOE LOADERS) Hydraulic Oil Filter.....	HC-45050
				Hydraulic Oil Filter.....	HC-45050
				WB142-5 (LOADERS) S4D102LE-2 Hydraulic Oil Filter.....	HC-45050
				Hydraulic Oil Filter.....	HC-45050
				WB146-5 (LOADERS) S4D102LE-2 Hydraulic Oil Filter.....	HC-45050
				Hydraulic Oil Filter.....	HC-45050



ENGINE APPLICATION

MODEL/APPLICATION	SAKURA NO	MODEL/APPLICATION	SAKURA NO	MODEL/APPLICATION	SAKURA NO
KOMATSU		KOMATSU		KOMATSU	
WB146PS-5 (LOADERS) S4D102LE-2 Hydraulic Oil Filter.....	HC-45050	Hydraulic Oil Filter.....	H-5652	WS235-2 (SCRAPERS) S6D140/3001 Hydraulic Oil Filter.....	H-5609
WB156-5 (LOADERS) S4D102LE-2 Hydraulic Oil Filter.....	HC-45050	WD600-3 (DOZERS) 2006 Hydraulic Oil Filter.....	H-5609	Hydraulic Oil Filter.....	H-5610
WB156PS-5 (LOADERS) S4D102LE-2 Hydraulic Oil Filter.....	HC-45050	WF22-2 (GRADERS) 1011 Hydraulic Oil Filter.....	H-5620	ZPA130EK (AIR COMPRESSORS) Hydraulic Oil Filter.....	HC-6217
WB70A (EXCAVATORS) 4D98E Hydraulic Oil Filter.....	HC-7906	Hydraulic Oil Filter.....	H-5610	KRUPP	
WB93-5 (BACKHOE LOADERS) F4GE-9484F Hydraulic Oil Filter.....	HC-45050	WF22A(T)-2 (GRADERS) NTC-743 Hydraulic Oil Filter.....	H-5620	GNTAT35 (CRANES) KHD F8L413F Hydraulic Oil Filter.....	HC-6802
WB93R-2 (BACKHOES) YANMAR/KMTWB003C77F26223 , 2005 Hydraulic Oil Filter.....	HC-45050	Hydraulic Oil Filter.....	H-56600	KUBOTA	
WB97R (EXCAVATORS) S/N: KMTWB015K77F50008 Hydraulic Oil Filter.....	HC-45050	Hydraulic Oil Filter.....	H-5610	B20 (TRACTORS) Hydraulic Oil Filter.....	HC-5816
WB97R-5 (BACKHOES) SAA4D104E , 2005 Hydraulic Oil Filter.....	HC-45050	WF22A-2 (GRADERS) NTC-743 Hydraulic Oil Filter.....	H-5620	B21 (TRACTORS) Hydraulic Oil Filter.....	HC-5816
WB93R-5 (BACKHOES) S4D104E-3 , 2005 Hydraulic Oil Filter.....	HC-45050	Hydraulic Oil Filter.....	H-56600	B21TL (TRACTORS) D1005 Hydraulic Oil Filter.....	HC-5816
WB93S-5 (BACKHOES) S4D104E-3 , 2005 Hydraulic Oil Filter.....	HC-45050	WF600T-1 (LOADERS) S6D140-1/10001 Hydraulic Oil Filter.....	H-5609	B21TLB (TRACTORS) D1005 Hydraulic Oil Filter.....	HC-5816
WB93S-5E0 (BACKHOES) S4D104E-3 , 2005 Hydraulic Oil Filter.....	HC-45050	Hydraulic Oil Filter.....	H-5618	B8200HST (TRACTORS) D950A-DT Hydraulic Oil Filter.....	HC-8805
WB95R-1 (LOADERS) Hydraulic Oil Filter.....	HC-7913	Hydraulic Oil Filter.....	H-5652	B9200HST (TRACTORS) Hydraulic Oil Filter.....	HC-8805
WB97S-5E0 (BACKHOE LOADERS) Hydraulic Oil Filter.....	HC-45050	WS16S-1 (SCRAPERS) NTA-855 Hydraulic Oil Filter.....	H-5609	F3680 (MOWERS) KUBOTA V1505 Hydraulic Oil Filter Transmission...	HC-52020
WB93R-5E0 (BACKHOES) Hydraulic Oil Filter.....	HC-45050	Hydraulic Oil Filter.....	H-5609	KH1/D (EXCAVATORS) Hydraulic Oil Filter.....	HC-5807
WB93R-5E0 (BACKHOES) S4D104E-3 , 2005 Hydraulic Oil Filter.....	HC-45050	WS16S-2 (SCRAPERS) NTA-855 Hydraulic Oil Filter.....	H-5610	KH10 (EXCAVATORS) Hydraulic Oil Filter.....	HC-5807
WB97R-1 (LOADERS) Hydraulic Oil Filter.....	HC-7913	Hydraulic Oil Filter.....	H-56600	KH101 (EXCAVATORS) Hydraulic Oil Filter.....	HC-5807
WD6001 (DOZERS) Hydraulic Oil Filter.....	H-5618	WS23-2 (SCRAPERS) S/N: 2001 Hydraulic Oil Filter.....	H-5610	KH11/16 (EXCAVATORS) D1302BH , 1993-1993 Hydraulic Oil Filter.....	HC-5807
		Hydraulic Oil Filter.....	H-5609	KH130 (EXCAVATORS) V1902-BH2 , 1990-1990 Hydraulic Oil Filter.....	HC-5602
		WS23-1 (SCRAPERS) NTA-855 Hydraulic Oil Filter.....	H-5610	KH14/15 (EXCAVATORS) D1301BH , 1993-1993 Hydraulic Oil Filter.....	HC-5807
		Hydraulic Oil Filter.....	H-5610		



ENGINE APPLICATION

MODEL/APPLICATION	SAKURA NO	MODEL/APPLICATION	SAKURA NO	MODEL/APPLICATION	SAKURA NO
KUBOTA		KUBOTA		KUBOTA	
KH14/15 (EXCAVATORS) D1301BH , 1993-1993		KX161-2 (EXCAVATORS) S/N : 50134		L4240 (TRACTORS)	
		Hydraulic Oil Filter.....	H-7956	Hydraulic Oil Filter.....	HC-5816
KH170L (EXCAVATORS)		KX161-2 (EXCAVATORS) S/N : 50135		L4240HST (TRACTORS)	
Hydraulic Oil Filter.....	HC-5602	Hydraulic Oil Filter.....	H-7956	Hydraulic Oil Filter.....	HC-5816
KH191 (EXCAVATORS) S2800D , 1990-1990		L2900F (TRACTORS)		L4240HSTC (TRACTORS)	
Hydraulic Oil Filter.....	HC-5602	Hydraulic Oil Filter.....	HC-5816	Hydraulic Oil Filter.....	HC-5816
KH28 (EXCAVATORS) S2600D , 1991-1991		L3010DT/GST/HST (TRACTORS)		L4310DT/GST/HST (TRACTORS)	
Hydraulic Oil Filter.....	HC-5602	Hydraulic Oil Filter.....	HC-8805	Hydraulic Oil Filter.....	HC-8805
KH35 (EXCAVATORS)		L3240 (TRACTORS)		L4350 (TRACTORS)	
Hydraulic Oil Filter Transmission..	HC-52010	Hydraulic Oil Filter.....	HC-5816	Hydraulic Oil Filter.....	HC-5816
KH36 (EXCAVATORS) Z620-KW , 1990-1990		L3240HST (TRACTORS)		L4740 (TRACTORS)	
Hydraulic Oil Filter Transmission..	HC-52010	Hydraulic Oil Filter.....	HC-5816	Hydraulic Oil Filter.....	HC-5816
KH41 (EXCAVATORS) D950-BH1 , 1990-1990		L3300 (TRACTORS) 1994		L48 (TRACTORS)	
Hydraulic Oil Filter Transmission..	HC-52010	Hydraulic Oil Filter.....	HC-5816	Hydraulic Oil Filter.....	HC-5816
KH50 (EXCAVATORS) D950BH		L3410DT/GST/HST (TRACTORS)		L4850 (TRACTORS)	
Hydraulic Oil Filter.....	HC-5807	Hydraulic Oil Filter.....	HC-8805	Hydraulic Oil Filter.....	HC-5816
KH51/55 (EXCAVATORS) D950-BH2		L35 (TRACTORS)		L4850DT (TRACTORS)	
Hydraulic Oil Filter.....	HC-5807	Hydraulic Oil Filter.....	HC-5816	Hydraulic Oil Filter.....	HC-5816
KH60 (EXCAVATORS) D1402-BH4 , 1991-1991		L3540HST (TRACTORS)		L5040 (TRACTORS)	
Hydraulic Oil Filter.....	HC-5807	Hydraulic Oil Filter.....	HC-5816	Hydraulic Oil Filter.....	HC-5816
KH60 (EXCAVATORS)		L35-TLB (TRACTORS)		L5240 (TRACTORS)	
Hydraulic Oil Filter.....	HC-5807	Hydraulic Oil Filter.....	HC-5816	Hydraulic Oil Filter.....	HC-5816
KH61 (EXCAVATORS)		L3600 (TRACTORS) 1994		L5740 (TRACTORS)	
Hydraulic Oil Filter.....	HC-5807	Hydraulic Oil Filter.....	HC-5816	Hydraulic Oil Filter.....	HC-5816
KH90 (EXCAVATORS)		L3600DT/GST (TRACTORS)		L5740HST (TRACTORS)	
Hydraulic Oil Filter.....	HC-5807	Hydraulic Oil Filter.....	HC-5816	Hydraulic Oil Filter.....	HC-5816
KX101 (EXCAVATORS) V1902-BH5 , 1992-1992		L3710DT/GST/HST (TRACTORS)		M105 (TRACTORS)	
Hydraulic Oil Filter.....	H-7956	Hydraulic Oil Filter.....	HC-8805	Hydraulic Oil Filter.....	HC-5816
KX101H (EXCAVATORS)		L3940 (TRACTORS)		M108 (TRACTORS) V3800DI-TI	
Hydraulic Oil Filter.....	H-7956	Hydraulic Oil Filter.....	HC-5816	Hydraulic Oil Filter.....	HC-5816
KX121-2 (EXCAVATORS) S/N : 55135		L4200 (TRACTORS) 1994		M108SDC (TRACTORS) V3800DI-TI	
Hydraulic Oil Filter.....	H-7956	Hydraulic Oil Filter.....	HC-5816	Hydraulic Oil Filter.....	HC-5816
KX151H (EXCAVATORS)		L4200DT/GSTC (TRACTORS)		M110DT (TRACTORS)	
Hydraulic Oil Filter.....	H-7956	Hydraulic Oil Filter.....	HC-5816	Hydraulic Oil Filter.....	HC-5816



ENGINE APPLICATION

MODEL/APPLICATION	SAKURA NO	MODEL/APPLICATION	SAKURA NO	MODEL/APPLICATION	SAKURA NO
KUBOTA		KUBOTA		KUBOTA	
M120 (TRACTORS)		M7040F-1 (TRACTORS) V3307-DI-T		M9000 (TRACTORS) V3300-TIE	
Hydraulic Oil Filter.....	HC-5816	Hydraulic Oil Filter.....	HC-5816	Hydraulic Oil Filter.....	HC-5816
M125XDTC (TRACTORS) F5802-TE2		M7040FC-1 (TRACTORS) V3307-DI-T		M9000DTL (TRACTORS) V3300-TIE	
Hydraulic Oil Filter.....	HC-5816	Hydraulic Oil Filter.....	HC-5816	Hydraulic Oil Filter.....	HC-5816
M4050DT (TRACTORS)		M7040HD-1 (TRACTORS) V3307-DI-T		M9540 (TRACTORS) 2008	
Hydraulic Oil Filter.....	HC-5816	Hydraulic Oil Filter.....	HC-5816	Hydraulic Oil Filter.....	HC-5816
M4700 (TRACTORS)		M7040SUHD (TRACTORS) V3307		M9540DT-1 (TRACTORS) V3800DI-T	
Hydraulic Oil Filter.....	HC-5816	Hydraulic Oil Filter.....	HC-5816	Hydraulic Oil Filter.....	HC-5816
M4700DT (TRACTORS)		M7580DT (TRACTORS)		M9540DTC-1 (TRACTORS) V3800DI-T	
Hydraulic Oil Filter.....	HC-5816	Hydraulic Oil Filter.....	HC-5816	Hydraulic Oil Filter.....	HC-5816
M4800 (TRACTORS)		M8200 (TRACTORS)		M9540F-1 (TRACTORS) V3800DI-T	
Hydraulic Oil Filter.....	HC-5816	Hydraulic Oil Filter.....	HC-5816	Hydraulic Oil Filter.....	HC-5816
M4900 (TRACTORS)		M8200SDNB (TRACTORS) V3300		M9540FC-1 (TRACTORS) V3800DI-T	
Hydraulic Oil Filter.....	HC-5816	Hydraulic Oil Filter.....	HC-5816	Hydraulic Oil Filter.....	HC-5816
M5400 (TRACTORS)		M8540 (TRACTORS) 2008		M9540HD-1 (TRACTORS) V3800DI-T	
Hydraulic Oil Filter.....	HC-5816	Hydraulic Oil Filter.....	HC-5816	Hydraulic Oil Filter.....	HC-5816
M5700 (TRACTORS) F2803EA		M8540DTC-1 (TRACTORS) V3800DI-T		M9540HDC24-1 (TRACTORS) V3800DI-T	
Hydraulic Oil Filter.....	HC-5816	Hydraulic Oil Filter.....	HC-5816	Hydraulic Oil Filter.....	HC-5816
M5700SDN (TRACTORS)		M8540F-1 (TRACTORS) V3800DI-T		M955 (TRACTORS)	
Hydraulic Oil Filter.....	HC-5816	Hydraulic Oil Filter.....	HC-5816	Hydraulic Oil Filter.....	HC-5816
M6040 (TRACTORS) 2008		M8540FC-1 (TRACTORS) V3800DI-T		M96 (TRACTORS) V3800-DI-TE3	
Hydraulic Oil Filter.....	HC-5816	Hydraulic Oil Filter.....	HC-5816	Hydraulic Oil Filter.....	HC-5816
M6040DT-1 (TRACTORS) V3307-DI-T		M8540HD-1 (TRACTORS) V3800DI-T		M96SHDM (TRACTORS) V3800-DI-TE3	
Hydraulic Oil Filter.....	HC-5816	Hydraulic Oil Filter.....	HC-5816	Hydraulic Oil Filter.....	HC-5816
M6040FC-1 (TRACTORS) V3307-DI-T		M8540HDC-1 (TRACTORS) V3800DI-T		R400 (LOADERS)	
Hydraulic Oil Filter.....	HC-5816	Hydraulic Oil Filter.....	HC-5816	Hydraulic Oil Filter.....	HC-5807
M6040HD-1 (TRACTORS) V3307-DI-T		M8540HDC12-1 (TRACTORS) V3800DI-T		RTV1100 (UTILITY VEHICLE)	
Hydraulic Oil Filter.....	HC-5816	Hydraulic Oil Filter.....	HC-5816	Hydraulic Oil Filter Suction.....	HC-18051
M6800 (TRACTORS)		M8540N (TRACTORS) V3800DI-T		RTV1140 CPX (UTILITY VEHICLE)	
Hydraulic Oil Filter.....	HC-5816	Hydraulic Oil Filter.....	HC-5816	Hydraulic Oil Filter Suction.....	HC-18051
M7040 (TRACTORS) 2008		M8580DT (TRACTORS)		RW25 (EXCAVATORS) V1500-BDW , 1990-1990	
Hydraulic Oil Filter.....	HC-5816	Hydraulic Oil Filter.....	HC-5816	Hydraulic Oil Filter.....	HC-5807
M7040DT-1 (TRACTORS) V3307-DI-T		M9000 (TRACTORS)		U25-3 (EXCAVATORS) KUBOTA	
Hydraulic Oil Filter.....	HC-5816	Hydraulic Oil Filter.....	HC-5816	Hydraulic Oil Filter.....	H-2712



ENGINE APPLICATION

MODEL/APPLICATION	SAKURA NO	MODEL/APPLICATION	SAKURA NO	MODEL/APPLICATION	SAKURA NO
KUBOTA		LAMBORGHINI AUTOMOBILI		LETOURNEAU-WESTINGHOUSE	
U35 (EXCAVATORS)		774 (TRACTORS)		800 SPEEDPULL (SCRAPERS) CUMMINS VTA28-C	
Hydraulic Oil Filter.....	H-2712	Hydraulic Oil Filter.....	HC-45110	Hydraulic Oil Filter Transmission...	H-65030
Hydraulic Oil Filter.....	H-7956				
K.W.DART		774-80 (TRACTORS)		B TOURNAPULL (SCRAPERS) CUMMINS NRT0-6	
2330 (CONSTRUCTION EQUIPMENTS) DETROITD 12V-71		Hydraulic Oil Filter.....	HC-45110	Hydraulic Oil Filter Transmission...	H-65030
Hydraulic Oil Filter Transmission...	H-65030				
D4655 (CONSTRUCTION EQUIPMENTS) DETROITD 16V-71		854 (TRACTORS)		B TOURNAPULL (SCRAPERS) DETROITD 12V-71	
Hydraulic Oil Filter Transmission...	H-65030	Hydraulic Oil Filter.....	HC-51040	Hydraulic Oil Filter Transmission...	H-65030
		Hydraulic Oil Filter.....	HC-45110		
LAMBORGHINI AUTOMOBILI		874-90T (TRACTORS)		B TOURNAPULL (SCRAPERS) DETROITD 6-110	
1056 (TRACTORS)		Hydraulic Oil Filter.....	HC-45110	Hydraulic Oil Filter Transmission...	H-65030
Hydraulic Oil Filter.....	HC-45110				
1106 (TRACTORS)		955 (TRACTORS)		B TOURNAPULL (SCRAPERS) LETOURNE NHRB 1S-6	
Hydraulic Oil Filter.....	HC-51040	Hydraulic Oil Filter.....	HC-45110	Hydraulic Oil Filter Transmission...	H-65030
		Hydraulic Oil Filter.....	HC-51040		
1156 (TRACTORS)		956 (TRACTORS)		C-500 TURNAPULL (SCRAPERS) DETROITD 8V-71	
Hydraulic Oil Filter.....	HC-45110	Hydraulic Oil Filter.....	HC-51040	Hydraulic Oil Filter Transmission...	H-65030
1256 (TRACTORS)		956-100 (TRACTORS)		C TOURNAPULL (SCRAPERS) CUMMINS NHS-6	
Hydraulic Oil Filter.....	HC-45110	Hydraulic Oil Filter.....	HC-51040	Hydraulic Oil Filter Transmission...	H-65030
1306 (TRACTORS)		FORMULA 105 (TRACTORS)		C TOURNAPULL (SCRAPERS) DETROIT DIESEL	
Hydraulic Oil Filter.....	HC-51040	Hydraulic Oil Filter.....	HC-45110	Hydraulic Oil Filter Transmission...	H-65030
1356 (TRACTORS)		LAVERDA		C TOURNAPULL (SCRAPERS) LETOURNE NB1S-6	
Hydraulic Oil Filter.....	HC-45110	3550AL (COMBINES) IVECO 8061SRI25		Hydraulic Oil Filter Transmission...	H-65030
		Hydraulic Oil Filter.....	HC-62020		
1506 (TRACTORS)		3850 (COMBINES) IVECO 8361		D TOURNAPULL (SCRAPERS) DETROITD 4-71	
Hydraulic Oil Filter.....	HC-51040	Hydraulic Oil Filter.....	HC-62020	Hydraulic Oil Filter Transmission...	H-65030
1556 (TRACTORS)		AL59 (COMBINES) FORD 675TA/8		LW-100 (CONSTRUCTION TRUCKS) CUMMINS VT-1710	
Hydraulic Oil Filter.....	HC-45110	Hydraulic Oil Filter.....	HC-7906	Hydraulic Oil Filter Transmission...	H-65030
		Hydraulic Oil Filter.....	HC-5504		
1706 (TRACTORS)		MX240 (COMBINES) IVECO 8210		LW-22 (CONSTRUCTION TRUCKS) CUMMINS NHRS-6	
Hydraulic Oil Filter.....	HC-45110	Hydraulic Oil Filter.....	HC-62020	Hydraulic Oil Filter Transmission...	H-65030
Hydraulic Oil Filter.....	HC-51040				
583 (TRACTORS)		MX300 (COMBINES) IVECO 8210		LW-27 (CONSTRUCTION TRUCKS) CUMMINS NT-855	
Hydraulic Oil Filter.....	HC-45110	Hydraulic Oil Filter.....	HC-62020	Hydraulic Oil Filter Transmission...	H-65030
660 (TRACTORS)		LECTRA HAUL		LW-32 (CONSTRUCTION TRUCKS) CUMMINS NTA-855	
Hydraulic Oil Filter.....	HC-51040	M-100 (SHOVELS) DETROIT DIESEL		Hydraulic Oil Filter Transmission...	H-65030
		Hydraulic Oil Filter.....	H-5405		
754 (TRACTORS)		LETOURNEAU-WESTINGHOUSE		LW40 (CONSTRUCTION TRUCKS) CUMMINS	
Hydraulic Oil Filter.....	HC-45110			Hydraulic Oil Filter Transmission...	H-65030
Hydraulic Oil Filter.....	HC-51040	330 (GRADERS) CUMMINS		LW40 (CONSTRUCTION TRUCKS) DETROITD 12V-71	
		Hydraulic Oil Filter Transmission...	H-65030	Hydraulic Oil Filter Transmission...	H-65030
				LW-60 (CONSTRUCTION TRUCKS) CUMMINS VT-1710	
				Hydraulic Oil Filter Transmission...	H-65030



ENGINE APPLICATION

MODEL/APPLICATION	SAKURA NO	MODEL/APPLICATION	SAKURA NO	MODEL/APPLICATION	SAKURA NO
LETOURNEAU-WESTINGHOUSE		LIEBHERR		LIEBHERR	
LW-60 (CONSTRUCTION TRUCKS) CUMMINS VTA-171		Hydraulic Oil Filter.....	HC-1822	LH843 (CRANES)	
Hydraulic Oil Filter Transmission...	H-65030	Hydraulic Oil Filter.....	H-62010	Hydraulic Oil Filter.....	H-62120
LW-60 (CONSTRUCTION TRUCKS) DETROITD 16V-71		A312 (EXCAVATORS) DEUTZ BFM 1012 , 1994-UP		LH853 (CRANES)	
Hydraulic Oil Filter Transmission...	H-65030	Hydraulic Oil Filter.....	H-62010	Hydraulic Oil Filter.....	H-62120
LW-90 (CONSTRUCTION TRUCKS) CUMMINS		Hydraulic Oil Filter.....	HC-1822	LR622 (LOADERS) S/N: 2201-UP	
Hydraulic Oil Filter Transmission...	H-65030	A900C (EXCAVATORS) DEUTZ BF4L913 , 1989-UP		Hydraulic Oil Filter.....	HC-62020
LEYLAND-DAF		Hydraulic Oil Filter.....	HC-6802	LR622 (LOADERS) S/N: 5600-UP	
ROYAL TIGER (BUSES) LEYLAND TL11		A911 (EXCAVATORS) DEUTZ F4L912		Hydraulic Oil Filter.....	HC-62020
Hydraulic Oil Filter.....	H-51170	Hydraulic Oil Filter.....	H-62020	LR622 (LOADERS) S/N: TO-2029	
TIGER (BUSES) LEYLAND TL11/31/57		A911C (EXCAVATORS) DEUTZ F5L912		Hydraulic Oil Filter.....	HC-62020
Hydraulic Oil Filter.....	H-51170	Hydraulic Oil Filter.....	H-62020	LR622 (LOADERS) S/N: TO-2088	
Titan (BUSES) GARDNER 6LXB , 1969-1978		A912 (EXCAVATORS) DEUTZ F5/6L912		Hydraulic Oil Filter.....	HC-62020
Hydraulic Oil Filter.....	H-51170	Hydraulic Oil Filter.....	H-62020	LR622 (LOADERS) S/N: TO-2200	
LIBRA		A921B (EXCAVATORS) DEUTZ F6L912		Hydraulic Oil Filter.....	HC-62020
125S (CRANES)		Hydraulic Oil Filter.....	H-62020	LR631B (LOADERS)	
Hydraulic Oil Filter.....	HC-7906	A922 (EXCAVATORS)		Hydraulic Oil Filter.....	HC-62020
135S (CRANES)		Hydraulic Oil Filter.....	H-62010	LR632 (LOADERS) LIEBHERR D926TE	
Hydraulic Oil Filter.....	HC-7906	A942 (EXCAVATORS) DEUTZ , 1978-1987		Hydraulic Oil Filter.....	HC-62020
150S (CRANES)		Hydraulic Oil Filter.....	H-62010	LR641 (LOADERS) 1985-UP	
Hydraulic Oil Filter.....	HC-7906	A954 (EXCAVATORS) LIEBHERR D926TI-E		Hydraulic Oil Filter.....	HC-62020
150W (CRANES)		Hydraulic Oil Filter.....	H-62110	Hydraulic Oil Filter.....	H-62010
Hydraulic Oil Filter.....	HC-7906	L508 TYPE 232 (CRAWLER DOZERS) DEUTZ F3L913		LT1080 (CRANES) MERCEDES OM360	
LIEBHERR		Hydraulic Oil Filter.....	HC-1822	Hydraulic Oil Filter Transmission....	H-7102
631C (DOZERS) LIEBHERR D9406		Hydraulic Oil Filter.....	HC-7907	LTL1030 (CRANES)	
Hydraulic Oil Filter.....	HC-62020	L510 TYPE 340 (CRAWLER DOZERS) S/N: 0101-UP		Hydraulic Oil Filter.....	H-62050
A308 (EXCAVATORS) S/N: 0158-UP , 1996-UP		Hydraulic Oil Filter.....	HC-7907	LTM1030/1 (CRANES) S/N: 0017793-UP	
Hydraulic Oil Filter.....	H-62010	L511 (CRAWLER DOZERS) S/N: 0101-UP		Hydraulic Oil Filter Transmission...	HC-2701
A308 (EXCAVATORS) S/N: SR 0392-UP , 1996-UP		Hydraulic Oil Filter.....	HC-7907	LTM1030-2 (CRANES) MERCEDES OM906LA , 1998-UP	
Hydraulic Oil Filter.....	H-62010	L521 (CRAWLER DOZERS) S/N: 0101-UP		Hydraulic Oil Filter Transmission...	HC-2701
A308 (EXCAVATORS) S/N: TO-0157 , 1996-UP		Hydraulic Oil Filter.....	HC-7907	LTM1030-2 (CRANES)	
Hydraulic Oil Filter.....	H-62010	L531 (CRAWLER DOZERS) LIEBHERR LIEBHERR/ DEUTZ , 1986-UP		Hydraulic Oil Filter Transmission...	HC-76130
A309 TYPE 717 (EXCAVATORS) 2004-UP		Hydraulic Oil Filter.....	HC-7907	LTM1030-2.1 (CRANES) S/N: 217908-217918	
Hydraulic Oil Filter.....	HC-1822	Hydraulic Oil Filter.....	H-62020	Hydraulic Oil Filter Transmission...	HC-2701
A310B (EXCAVATORS) DEUTZ BFM 1012 , 1995-UP		L551 (CRAWLER DOZERS) LIEBHERR D906 TB , 1984-UP		LTM1030-2.1 (CRANES) S/N: 217919-218263	
		Hydraulic Oil Filter.....	H-62020		



ENGINE APPLICATION

MODEL/APPLICATION	SAKURA NO	MODEL/APPLICATION	SAKURA NO	MODEL/APPLICATION	SAKURA NO
LIEBHERR		LIEBHERR		LIEBHERR	
LTM1030-2.1 (CRANES) S/N: Z17919-Z18263	Hydraulic Oil Filter Transmission... HC-2701	Hydraulic Oil Filter..... H-62070		PR722 LITRONIC (CRAWLER DOZERS)	
LTM1030-2.1 (CRANES) S/N: Z18264-UP	Hydraulic Oil Filter Transmission.. HC-76130	Hydraulic Oil Filter Transmission.. HC-76130		Hydraulic Oil Filter..... HC-6802	
LTM1040 (CRANES) LIEBHERR D926TI	Hydraulic Oil Filter Transmission... HC-2701	LTM1080/1 (CRANES) S/N: Z61270-UP	Hydraulic Oil Filter..... H-62070	PR731 (CRAWLER DOZERS) LIEBHERR D94/6	Hydraulic Oil Filter..... HC-6802
LTM1040-1 (CRANES) S/N: 0019269-UP	Hydraulic Oil Filter Transmission... HC-2701	Hydraulic Oil Filter Transmission.. HC-76130		PR731 (CRAWLER DOZERS) MERCEDES OM401	Hydraulic Oil Filter..... HC-6802
LTM1045 (CRANES) MERCEDES OM422LA	Hydraulic Oil Filter Transmission... HC-2701	Hydraulic Oil Filter..... H-62050		PR731C (CRAWLER DOZERS) LIEBHERR MERCEDES/LIEBHERR	Hydraulic Oil Filter..... HC-62020
LTM1050-1 (CRANES) LIEBHERR D926TI	Hydraulic Oil Filter Transmission... HC-2701	LTM1090 (CRANES) MERCEDES OM442	Hydraulic Oil Filter Transmission... H-53010	PR732 (CRAWLER DOZERS) 1990-UP	Hydraulic Oil Filter..... HC-62020
LTM1050-1 (CRANES) S/N: Z24000-Z24467	Hydraulic Oil Filter Transmission... HC-2701	LTM1100-5.1 (CRANES) S/N: Z65000-Z65159	Hydraulic Oil Filter Transmission.... H-7102	PR741C (CRAWLER DOZERS)	Hydraulic Oil Filter..... HC-62020
LTM1050-1 (CRANES) S/N: Z24468-UP	Hydraulic Oil Filter Transmission... HC-2701	Hydraulic Oil Filter..... H-62070		PR742 (CRAWLER DOZERS) 1991-UP	Hydraulic Oil Filter..... HC-62020
LTM1055 S/4 (CRANES) S/N: Z24468-UP , 1999-UP	Hydraulic Oil Filter Transmission.... H-7102	LTM1100-5.1 (CRANES) S/N: Z65160-Z65215	Hydraulic Oil Filter Transmission.... H-7102	PR751 (CRAWLER DOZERS) CUMMINS KT-1150	Hydraulic Oil Filter..... HC-62020
LTM1055/1 (CRANES) LIEBHERR D926TI , 2000-UP	Hydraulic Oil Filter..... H-62050	Hydraulic Oil Filter..... H-62070		R912 (EXCAVATORS) LIEBHERR D904 NA	Hydraulic Oil Filter..... H-62020
LTM1055-3.1 (CRANES) S/N: Z55200-UP	Hydraulic Oil Filter..... H-62050	LTM1200/1 (CRANES) S/N: Z70086-UP	Hydraulic Oil Filter Transmission.... H-7102	R922 (EXCAVATORS) LIEBHERR D906 NA	Hydraulic Oil Filter..... H-62010
LTM1060/2 (CRANES) S/N: Z57432-UP	Hydraulic Oil Filter..... H-62070	LTM1400-7.1 (CRANES) S/N: Z72000-UP	Hydraulic Oil Filter..... H-62070	R922LC (EXCAVATORS) DEUTZ F6L912	Hydraulic Oil Filter..... H-62010
LTM1060/2 (CRANES) S/N: Z57432-UP	Hydraulic Oil Filter..... H-62050	MK100 (CRANES) S/N: Z77250-UP , 2004-UP	Hydraulic Oil Filter Transmission.... H-7102	R925 (EXCAVATORS)	Hydraulic Oil Filter..... H-85110
LTM1060/2 (CRANES) S/N: Z57432-UP	Hydraulic Oil Filter Transmission.. HC-76130	PR (DOZERS) 711/M Mercedes OM 352	Hydraulic Oil Filter..... H-55330	R932 (EXCAVATORS) DEUTZ BF6L913	Hydraulic Oil Filter..... H-62010
LTM1080/1 (CRANES) S/N: Z23801-Z25287	Hydraulic Oil Filter..... H-62070	PR (DOZERS) 731 Mercedes-Benz OM401	Hydraulic Oil Filter..... HC-62020	R941 (EXCAVATORS) DEUTZ F6L912	Hydraulic Oil Filter..... H-62010
LTM1080/1 (CRANES) S/N: Z23801-Z25287	Hydraulic Oil Filter..... HC-6802	PR (DOZERS) 741/B/C DB OM 402/421 A	Hydraulic Oil Filter..... HC-62020	R941B (EXCAVATORS) DEUTZ BF6L912	Hydraulic Oil Filter..... H-62010
LTM1080/1 (CRANES) S/N: Z23801-Z25287	Hydraulic Oil Filter..... H-62050	PR712 (CRAWLER DOZERS)	Hydraulic Oil Filter..... HC-62020	R942 (EXCAVATORS) DEUTZ BF6L913B	Hydraulic Oil Filter..... H-62010
LTM1080/1 (CRANES) S/N: Z61046-Z61269	Hydraulic Oil Filter..... H-62050	PR712 LITRONIC (CRAWLER DOZERS) LIEBHERR MERCEDES/LIEBHERR , 1988-UP	Hydraulic Oil Filter..... HC-6802		
		PR721C (CRAWLER DOZERS) 1988-UP	Hydraulic Oil Filter..... HC-62020		



ENGINE APPLICATION

MODEL/APPLICATION	SAKURA NO	MODEL/APPLICATION	SAKURA NO	MODEL/APPLICATION	SAKURA NO
LIEBHERR		LIEBHERR		LINKBELT	
R954 (EXCAVATORS) LIEBHERR D926TI-E Hydraulic Oil Filter.....	H-62110	R974B-LITRONIC (EXCAVATORS) LIEBHERR D9408TI Hydraulic Oil Filter.....	H-62110	LS3400FB (LOGGERS) ISUZU Hydraulic Oil Filter.....	HC-8805
R954 (EXCAVATORS) S/N: 1000-UP Hydraulic Oil Filter.....	HC-62020	R974-LITRONIC 0990 (EXCAVATORS) CUMMINS NTA-855 Hydraulic Oil Filter.....	H-62110	Hydraulic Oil Filter.....	H-2719
R954 (EXCAVATORS) S/N: 385-443 Hydraulic Oil Filter.....	HC-62020	R972HD (EXCAVATORS) CUMMINS NTA-855 Hydraulic Oil Filter.....	HC-6802	LS-408 (OTHERS) Hydraulic Oil Filter Transmission...	H-65030
R954 (EXCAVATORS) S/N: 444-990 Hydraulic Oil Filter.....	HC-62020	R974 LITRONIC (EXCAVATORS) CUMMINS NTA-855 Hydraulic Oil Filter.....	HC-62020	LINGONG	
R954 (EXCAVATORS) S/N: TO-0313 Hydraulic Oil Filter.....	HC-62020	R984 LITRONIC (EXCAVATORS) S/N: TO-0990 Hydraulic Oil Filter.....	HC-62020	205C (EXCAVATORS) 6BT5.9-C Hydraulic Oil Filter.....	H-85730
R954 (EXCAVATORS) S/N: TO-0384 Hydraulic Oil Filter.....	HC-62020	R981 (EXCAVATORS) DEUTZ BF6L913 Hydraulic Oil Filter.....	H-62010	225C (EXCAVATORS) 6BT5.9-C Hydraulic Oil Filter.....	H-85730
R954B (EXCAVATORS) LIEBHERR D926TI-E Hydraulic Oil Filter.....	H-62110	R982 (EXCAVATORS) CUMMINS NTA-855 Hydraulic Oil Filter.....	HC-6802	LIUGONG	
R 954 C (EXCAVATORS) LIEBHERR D936 , 2006-UP Hydraulic Oil Filter.....	H-7602	R982HD (EXCAVATORS) Hydraulic Oil Filter.....	HC-6802	842 (EXCAVATORS) CUMMINS 6B5.9 , 2005 Hydraulic Oil Filter Transmission...	HC-2701
R964 (EXCAVATORS) S/N: TO-0144 Hydraulic Oil Filter.....	HC-62020	R982HD (EXCAVATORS) Hydraulic Oil Filter.....	H-62120	856 (LOADERS) WD615G.220/6121 Hydraulic Oil Filter.....	H-85720
R964 (EXCAVATORS) S/N: TO-0168 Hydraulic Oil Filter.....	HC-62020	LINDE		888 (EXCAVATORS) CUMMINS , 2005 Hydraulic Oil Filter.....	HC-6802
R964 (EXCAVATORS) S/N: TO-0224 Hydraulic Oil Filter.....	HC-62020	H25 (FORKLIFTS) KHD F4L912 Hydraulic Oil Filter.....	HC-62020	908C (EXCAVATORS) B3.3T Hydraulic Oil Filter.....	H-85730
R961 (EXCAVATORS) DEUTZ F6L413 Hydraulic Oil Filter.....	H-62010	H25 (FORKLIFTS) KHD F3L912 Hydraulic Oil Filter.....	HC-62020	915C (EXCAVATORS) BTA3.9 Hydraulic Oil Filter.....	H-85730
R961 (EXCAVATORS) DEUTZ F8L413 Hydraulic Oil Filter.....	H-62010	H25 (FORKLIFTS) KHD F3L913 Hydraulic Oil Filter.....	HC-62020	922LC (EXCAVATORS) 6BT5.9-C Hydraulic Oil Filter.....	H-85730
R962 (EXCAVATORS) CUMMINS NTT-855C Hydraulic Oil Filter.....	HC-6802	LINDNER		925LC (EXCAVATORS) 6BTA5.9-C Hydraulic Oil Filter.....	H-85730
R974B 1206 (EXCAVATORS) CUMMINS NTA-855 Hydraulic Oil Filter.....	H-62110	Geotrac 63 (TRACTORS) PERKINS 3.3L 3-cyl diesel Hydraulic Oil Filter Transmission..	HC-85210	925LL (EXCAVATORS) B5.9C Hydraulic Oil Filter.....	H-85730
R974B 1207 (EXCAVATORS) CUMMINS NTA-855 Hydraulic Oil Filter.....	H-62110	Geotrac 73 (TRACTORS) PERKINS 3.3L 3-cyl diesel Hydraulic Oil Filter Transmission..	HC-85210	936LC (EXCAVATORS) 6CAT8.3-C260 Hydraulic Oil Filter.....	H-85730
R974B-9079 (EXCAVATORS) CUMMINS NTA-855 Hydraulic Oil Filter.....	H-62110	LINKBELT		CLG856 (LOADERS) Hydraulic Oil Filter.....	H-85720
		2650 QUANTUM (EXCAVATORS) w/Isuzu 48G1T Eng Hydraulic Oil Filter.....	H-5519	CLG856 (WHEEL LOADERS) DCEC Hydraulic Oil Filter.....	H-38040
		2700 QUANTUM (EXCAVATORS) w/Isuzu A-48G1T Eng Hydraulic Oil Filter.....	H-5519	CLG842 (EXCAVATORS) CUMMINS 6B5.9 , 2005	



ENGINE APPLICATION

MODEL/APPLICATION	SAKURA NO	MODEL/APPLICATION	SAKURA NO	MODEL/APPLICATION	SAKURA NO
LIUGONG		LONKING		MAN	
CLG842 (EXCAVATORS) CUMMINS 685.9 , 2005 Hydraulic Oil Filter Transmission...	HC-2701	LG855 (LOADERS) WD615G.220 Hydraulic Oil Filter.....	H-42150	NG312 (BUSES) MAN D2865 , 1995-UP Hydraulic Oil Filter Transmission....	H-7102
CLG888 (EXCAVATORS) CUMMINS CUMMINS , 2005 Hydraulic Oil Filter.....	HC-6802	ZL50C (LOADERS) WD10G220E11 Hydraulic Oil Filter.....	H-42120	NL202 (BUSES) MAN D0826 LUH , 1989-1997 Hydraulic Oil Filter Transmission....	H-7102
ZL30E (LOADERS) Hydraulic Oil Filter.....	H-85670	LOSENHAUSEN		NL222 (BUSES) MAN D0826 LUH12 , 1995-UP Hydraulic Oil Filter Transmission....	H-7102
ZL30E (LOADERS) YC6108G Hydraulic Oil Filter.....	H-85670	1501 (ROLLERS) KHD Hydraulic Oil Filter.....	HC-5502	NL223 (BUSES) MAN D0826 , 1999-UP Hydraulic Oil Filter Transmission....	H-7102
ZL50C (LOADERS) WD6150 220 Hydraulic Oil Filter.....	H-85700	MACK		NL243 (BUSES) MAN D0836 LOH , 2002-UP Hydraulic Oil Filter Transmission....	H-7102
Hydraulic Oil Filter.....	H-38020	SOME MOD (TRUCKS) Hydraulic Oil Filter Power steering..	H-71160	NL263 (BUSES) MAN D0826 , 1999-UP Hydraulic Oil Filter Transmission....	H-7102
ZL50C (WHEEL LOADERS) Yuchai Hydraulic Oil Filter.....	H-38040	MAHINDRA		NL263 (BUSES) MAN D2866 , 1998-UP Hydraulic Oil Filter Transmission....	H-7102
LOCKWOOD		3325 (TRACTORS) 1.9L 3-CYL , 1900 Hydraulic Oil Filter.....	HC-7919	NL283 (BUSES) MAN D0836 LUH40 , 2002-UP Hydraulic Oil Filter Transmission....	H-7102
PECAN HARVESTER (HARVESTERS) Hydraulic Oil Filter.....	H-51170	3525 (TRACTORS) 1.9L 3-CYL , 1900 Hydraulic Oil Filter.....	HC-7919	NL313 (BUSES) MAN D2866 , 1999-UP Hydraulic Oil Filter Transmission....	H-7102
LOKOMO		MAN		NL363 (BUSES) MAN D2866 , 2000-UP Hydraulic Oil Filter Transmission....	H-7102
925 (FOREST EQUIPMENTS) PERKINS 6.354 Hydraulic Oil Filter Transmission...	H-65030	FE 310A F2000 EVOLUTION (TRUCKS) MAN D2866 , 2000-UP Hydraulic Oil Filter Transmission....	H-7102	NL363 (BUSES) MAN D2866 , 2000-UP Hydraulic Oil Filter Transmission....	H-7102
928 (FOREST EQUIPMENTS) DEUTZ BF6L913 Hydraulic Oil Filter Transmission...	H-65030	NG 262 (BUSES) MAN D0826 LUH , 1998-UP Hydraulic Oil Filter Transmission....	H-7102	NUE223 (BUSES) MAN D0826 , 1999-UP Hydraulic Oil Filter Transmission....	H-7102
990 (FOREST EQUIPMENTS) Hydraulic Oil Filter.....	H-76050	NG 263 (BUSES) MAN D0826 , 1999-UP Hydraulic Oil Filter Transmission....	H-7102	NUE263 (BUSES) MAN D0826 , 1999-2001 Hydraulic Oil Filter Transmission....	H-7102
AH132 (GRADERS) VALMET 611CS Hydraulic Oil Filter Transmission...	H-65030	NG 272 (BUSES) MAN D0826 LUH22 , 1998-UP Hydraulic Oil Filter Transmission....	H-7102	NUE263 (BUSES) MAN D2866 LUH22/23 , 1998-UP Hydraulic Oil Filter Transmission....	H-7102
TELLOKKERI (FOREST EQUIPMENTS) PERKINS Hydraulic Oil Filter Transmission...	H-65030	NG 272 (BUSES) MAN D0826 , 1990-1999 Hydraulic Oil Filter Transmission....	H-7102	NUE283 (BUSES) MAN D0836 LUH01 , 2001-UP Hydraulic Oil Filter Transmission....	H-7102
LONG		NG 313 (BUSES) MAN D2865 , 1998-UP Hydraulic Oil Filter Transmission....	H-7102	NUE313 (BUSES) MAN D0826 , 1999-UP Hydraulic Oil Filter Transmission....	H-7102
16497 (AGRICULTURE) Hydraulic Oil Filter.....	HC-7932	NG 363 (BUSES) MAN D2866 LUH25 , 2001-UP Hydraulic Oil Filter Transmission....	H-7102	NUE313 (BUSES) MAN D2866 LUH26 , 1998-UP Hydraulic Oil Filter Transmission....	H-7102
23833 (AGRICULTURE) Hydraulic Oil Filter.....	HC-7932	NG312 (BUSES) MAN D2865 LUH07 , 1998-UP Hydraulic Oil Filter Transmission....	H-7102	NUE353 (BUSES) MAN D2866 LUH21 , 1998-2001 Hydraulic Oil Filter Transmission....	H-7102
39563 (AGRICULTURE) Hydraulic Oil Filter.....	HC-7932	LONKING			



ENGINE APPLICATION

MODEL/APPLICATION	SAKURA NO	MODEL/APPLICATION	SAKURA NO	MODEL/APPLICATION	SAKURA NO
MAN		MANITOU		MANITOU	
NUE353 (BUSES) MAN D2866 LUH25 , 1998-2001 Hydraulic Oil Filter Transmission....	H-7102	165ATJ (FORKLIFTS) PERKINS PERKINS Hydraulic Oil Filter.....	HC-7905	M 26.2 (FORKLIFTS) 1990-UP Hydraulic Oil Filter.....	H-51220
SUE223 (BUSES) MAN D0826 , 1999-UP Hydraulic Oil Filter Transmission....	H-7102	4RM36K (FORKLIFTS) IHC D239 , 2004 Hydraulic Oil Filter.....	H-51220	M 26.4 CP (FORKLIFTS) 1990-UP Hydraulic Oil Filter.....	H-51220
SUE263 (BUSES) MAN D2866 , 1999-UP Hydraulic Oil Filter Transmission....	H-7102	4RM36K (FORKLIFTS) IHC D179 , 2004 Hydraulic Oil Filter.....	H-51220	M2/M4 26-30HE HMV (FORKLIFTS) Hydraulic Oil Filter.....	H-51220
SUE283 (BUSES) MAN D0836 LOH , 2001-UP Hydraulic Oil Filter Transmission....	H-7102	4RM40K (FORKLIFTS) IHC D239 , 2004 Hydraulic Oil Filter.....	H-51220	M4 40 CP (FORKLIFTS) Hydraulic Oil Filter.....	H-51220
SUE313 (BUSES) MAN D2866 LUH EURO3 , 2001-UP Hydraulic Oil Filter Transmission....	H-7102	4RM40K (FORKLIFTS) IHC D179 , 2004 Hydraulic Oil Filter.....	H-51220	Hydraulic Oil Filter.....	HC-5501
SUE313 (BUSES) MAN D2866 EURO2 , 1999-UP Hydraulic Oil Filter Transmission....	H-7102	4RM50K (FORKLIFTS) IHC D239 , 2004 Hydraulic Oil Filter.....	H-51220	MANITOUOL (FORKLIFTS) Hydraulic Oil Filter.....	
SUE322 (BUSES) MAN D2865 , 1995-UP Hydraulic Oil Filter Transmission....	H-7102	4RM50K (FORKLIFTS) IHC D179 , 2004 Hydraulic Oil Filter.....	H-51220	MB 20 C (FORKLIFTS) Hydraulic Oil Filter.....	H-51220
TGA 18.310 (TRUCKS) 18.310 D20, 18.313 D20 , 2004 Hydraulic Oil Filter Transmission....	H-7103	4 RM 20 C (FORKLIFTS) Hydraulic Oil Filter.....	H-51220	MB 20 CL (FORKLIFTS) Hydraulic Oil Filter.....	H-51220
TGS 18.320 (TRUCKS) 18.320 D 2066 , 2007 Hydraulic Oil Filter Transmission....	H-7103	4 RM 26 (FORKLIFTS) Hydraulic Oil Filter.....	HC-5501	MB 21 NP (FORKLIFTS) IHC BD154 Hydraulic Oil Filter.....	HC-5501
TGS 18.360 (TRUCKS) 18.360 D 2066 , 2007 Hydraulic Oil Filter Power steering..	H-71180	4 RM 26 PC (FORKLIFTS) Hydraulic Oil Filter.....	H-51220	MB 26 PC (FORKLIFTS) Hydraulic Oil Filter.....	H-51220
TGS 18.360 (TRUCKS) 18.360 D 2066 , 2007 Hydraulic Oil Filter Power steering..	H-71180	BT220 (FORKLIFTS) 1993-UP Hydraulic Oil Filter.....	HC-7907	MB 30 G (FORKLIFTS) Hydraulic Oil Filter.....	H-51220
TGS 18.360 (TRUCKS) 18.360 D 2066 , 2007 Hydraulic Oil Filter Transmission....	H-7103	Hydraulic Oil Filter.....	H-51220	MB50 K (FORKLIFTS) IHC D239 , 2004-UP Hydraulic Oil Filter.....	H-51220
TGX 18.360 (TRUCKS) 18.360 D 2066 , 2007 Hydraulic Oil Filter Power steering..	H-71180	BT420 (FORKLIFTS) 1993-UP Hydraulic Oil Filter.....	HC-7906	IHC D179 , 2004-UP Hydraulic Oil Filter.....	H-51220
TGX 18.360 (TRUCKS) 18.360 D 2066 , 2007 Hydraulic Oil Filter Transmission....	H-7103	Hydraulic Oil Filter.....	H-51220	MB50 K (FORKLIFTS) IHC D239 , 2004 Hydraulic Oil Filter.....	H-51220
TGX 18.540 (TRUCKS) 18.540 D 2676 , 2007 Hydraulic Oil Filter Power steering..	H-71180	CI 225 H (FORKLIFTS) Hydraulic Oil Filter.....	H-51220	MB50 K (FORKLIFTS) IHC D179 , 2004 Hydraulic Oil Filter.....	H-51220
TGX 18.540 (TRUCKS) 18.540 D 2676 , 2007 Hydraulic Oil Filter Transmission....	H-7103	M2 26-30 CP (FORKLIFTS) Hydraulic Oil Filter.....	HC-5501	MB50 K (FORKLIFTS) Hydraulic Oil Filter.....	H-51220
UEL242 (TRUCKS) MAN D2866 , 1989-1993 Hydraulic Oil Filter Transmission....	H-7102	M 26.4 (FORKLIFTS) PERKINS 104.19 , 1990-UP Hydraulic Oil Filter.....	H-51220	MC20 HP (FORKLIFTS) 1990-UP Hydraulic Oil Filter.....	H-51220
UEL272 (TRUCKS) MAN D2865 , 1993-1995 Hydraulic Oil Filter Transmission....	H-7102	M 26.4 (FORKLIFTS) PERKINS 104.19 , 1990 Hydraulic Oil Filter.....	H-51220	MC40 C (FORKLIFTS) 1995-UP	
MANITOU					
150ATS (FORKLIFTS) PERKINS PERKINS 1 SERIES Hydraulic Oil Filter.....	HC-7905				



ENGINE APPLICATION

MODEL/APPLICATION	SAKURA NO	MODEL/APPLICATION	SAKURA NO	MODEL/APPLICATION	SAKURA NO
MANITOU		MANITOU		MANITOU	
		Hydraulic Oil Filter.....	HC-62020	Hydraulic Oil Filter.....	H-51220
MC40 C (<i>FORKLIFTS</i>) 1995-UP	H-51220	MI205 GPL (<i>FORKLIFTS</i>)		MLT626 (<i>FORKLIFTS</i>) S/N: 3 SERIES-UP	
Hydraulic Oil Filter.....		Hydraulic Oil Filter.....	HC-62020	Hydraulic Oil Filter.....	H-51220
MC40 CP (<i>FORKLIFTS</i>) 1995-UP	H-51220	MI235 (<i>FORKLIFTS</i>)		MLT626-725 (<i>FORKLIFTS</i>) S/N: 2 SERIES-UP	
Hydraulic Oil Filter.....		Hydraulic Oil Filter.....	HC-62020	Hydraulic Oil Filter.....	H-51220
MC40 FC (<i>FORKLIFTS</i>)		MI355 (<i>FORKLIFTS</i>)		MLT628 (<i>FORKLIFTS</i>) S/N: 1 SERIES-UP	
Hydraulic Oil Filter.....	H-51220	Hydraulic Oil Filter.....	HC-62020	Hydraulic Oil Filter.....	H-51220
MC40 P (<i>FORKLIFTS</i>)		MI355E (<i>FORKLIFTS</i>)		MLT630 (<i>FORKLIFTS</i>) S/N: A SERIES-UP , 1999-UP	
Hydraulic Oil Filter.....	HC-5501	Hydraulic Oil Filter.....	HC-62020	Hydraulic Oil Filter.....	H-51220
Hydraulic Oil Filter.....	H-51220	MI50C (<i>FORKLIFTS</i>)		MLT630T (<i>FORKLIFTS</i>) S/N: 3 SERIES-UP	
MC40 TC (<i>FORKLIFTS</i>)		Hydraulic Oil Filter.....	HC-62020	Hydraulic Oil Filter.....	H-51220
Hydraulic Oil Filter.....	H-51220	MI70C (<i>FORKLIFTS</i>)		MLT630T (<i>FORKLIFTS</i>) S/N: 3 SERIES-UP , 1998-UP	
MC50 K (<i>FORKLIFTS</i>) IHC D239 , 2004		Hydraulic Oil Filter.....	HC-62020	Hydraulic Oil Filter.....	H-51220
Hydraulic Oil Filter.....	H-51220	ML632 (<i>FORKLIFTS</i>) S/N: 1 SERIES-UP		MLT632 (<i>FORKLIFTS</i>) S/N: 1 SERIES-UP	
MC50 K (<i>FORKLIFTS</i>) IHC D179 , 2004		Hydraulic Oil Filter.....	H-51220	Hydraulic Oil Filter.....	H-51220
Hydraulic Oil Filter.....	H-51220	ML632 (<i>FORKLIFTS</i>) S/N: 2 SERIES-UP		MLT632T (<i>FORKLIFTS</i>) S/N: 1 SERIES-UP	
MC50 (<i>FORKLIFTS</i>)		Hydraulic Oil Filter.....	H-51220	Hydraulic Oil Filter.....	H-51220
Hydraulic Oil Filter.....	H-51220	ML630 (<i>FORKLIFTS</i>)		MLT728 (<i>FORKLIFTS</i>) S/N: 1 SERIES-UP	
MC60 K (<i>FORKLIFTS</i>) IHC D239 , 2004		Hydraulic Oil Filter.....	H-51220	Hydraulic Oil Filter.....	H-51220
Hydraulic Oil Filter.....	H-51220	MLT523 1 SERIES (<i>FORKLIFTS</i>) PERKINS TURBO		MLT728T (<i>FORKLIFTS</i>) S/N: 1 SERIES-UP	
MC60 K (<i>FORKLIFTS</i>) IHC D179 , 2004		Hydraulic Oil Filter.....	H-51220	Hydraulic Oil Filter.....	H-51220
Hydraulic Oil Filter.....	H-51220	MLT523T (<i>FORKLIFTS</i>) PERKINS TURBO		MLT626-725T (<i>FORKLIFTS</i>) S/N: 2 SERIES-UP	
MC60 (<i>FORKLIFTS</i>) 1995-UP		Hydraulic Oil Filter.....	H-51220	Hydraulic Oil Filter.....	H-51220
Hydraulic Oil Filter.....	H-51220	MLT523T (<i>FORKLIFTS</i>) S/N: 2 SERIES-UP		MLT725 (<i>FORKLIFTS</i>) S/N: 3 SERIES-UP	
MCE20 H (<i>FORKLIFTS</i>)		Hydraulic Oil Filter.....	H-51220	Hydraulic Oil Filter.....	H-51220
Hydraulic Oil Filter.....	H-51220	MLT526T (<i>FORKLIFTS</i>) PERKINS TURBO		MSI 40 (<i>LOADERS</i>) PERKINS 1004-42 , 1997-UP	
MCE20 H GPL (<i>FORKLIFTS</i>)		Hydraulic Oil Filter.....	H-51220	Hydraulic Oil Filter.....	H-51220
Hydraulic Oil Filter.....	H-51220	MLT523 (<i>FORKLIFTS</i>)		MSI 40 (<i>LOADERS</i>) PERKINS 1004-42 , 1997	
MCE20 HZ (<i>FORKLIFTS</i>)		Hydraulic Oil Filter.....	H-51220	Hydraulic Oil Filter.....	H-51220
Hydraulic Oil Filter.....	H-51220	MLT523 (<i>FORKLIFTS</i>) PERKINS TURBO		MSI 50 (<i>LOADERS</i>) PERKINS 1004-42 , 1997	
MCE20 P (<i>FORKLIFTS</i>)		Hydraulic Oil Filter.....	H-51220	Hydraulic Oil Filter.....	H-51220
Hydraulic Oil Filter.....	H-51220	MLT524 (<i>FORKLIFTS</i>) S/N: 1 SERIES-UP , 1996-UP		MT 1233 S TURBO (<i>LOADERS</i>) PERKINS 1004.4T , 1994-UP	
MCE40 H (<i>FORKLIFTS</i>)		Hydraulic Oil Filter.....	H-51220	Hydraulic Oil Filter.....	H-51220
Hydraulic Oil Filter.....	H-51220	MLT526 (<i>FORKLIFTS</i>) S/N: A SERIES-UP		MT 1233 S TURBO (<i>LOADERS</i>) PERKINS 1004.4T , 1994	
MI205 (<i>FORKLIFTS</i>)					



ENGINE APPLICATION

MODEL/APPLICATION	SAKURA NO	MODEL/APPLICATION	SAKURA NO	MODEL/APPLICATION	SAKURA NO
MANITOU					
MT 1233 S TURBO (LOADERS) PERKINS 1004.4T , 1994 Hydraulic Oil Filter.....	H-51220	MT220 (FORKLIFTS) Hydraulic Oil Filter.....	H-51220	MT845 (FORKLIFTS) S/N: 1139267-UP , 2000-UP Hydraulic Oil Filter.....	H-51220
MT 1240 L TURBO/TURBO MONO-ULTRA 1 SERIES (LOADERS) PERKINS 1004.4T , 1994 Hydraulic Oil Filter.....	H-51220	MT222CP (FORKLIFTS) Hydraulic Oil Filter.....	H-51220	MT845 (FORKLIFTS) S/N: 1 SERIES-UP Hydraulic Oil Filter.....	H-51220
MT 1330 SL TURBO (LOADERS) PERKINS 1004.4T , 1994 Hydraulic Oil Filter.....	H-51220	MT222CP (FORKLIFTS) PERKINS 4.236 Hydraulic Oil Filter.....	HC-5501	MT830 (FORKLIFTS) Hydraulic Oil Filter.....	HC-7913
MT 1230 MCP (FORKLIFTS) Hydraulic Oil Filter.....	H-51220	MT222CP T (FORKLIFTS) Hydraulic Oil Filter.....	H-51220	MT830CP (FORKLIFTS) Hydraulic Oil Filter.....	H-51220
MT 1232 S (FORKLIFTS) S/N: 1 SERIES-UP Hydraulic Oil Filter.....	H-51220	MT225 H (FORKLIFTS) Hydraulic Oil Filter.....	H-51220	MT835-120LS (FORKLIFTS) S/N: 2 SERIES-UP Hydraulic Oil Filter.....	H-51220
MT 1232 S TURBO/TURBO MONO-ULTRA (FORKLIFTS) S/N: 1 SERIES-UP Hydraulic Oil Filter.....	H-51220	MT422CP (FORKLIFTS) PERKINS 4.236 Hydraulic Oil Filter.....	H-51220	MT845/940L (FORKLIFTS) S/N: 1 SERIES-UP Hydraulic Oil Filter.....	H-51220
MT1140T (FORKLIFTS) Hydraulic Oil Filter.....	HC-7913	MT425CP (FORKLIFTS) PERKINS 4.236 Hydraulic Oil Filter.....	H-51220	MT845/940L (FORKLIFTS) S/N: 2 SERIES-UP Hydraulic Oil Filter.....	H-51220
MT1230SCP (FORKLIFTS) S/N: C SERIES-UP Hydraulic Oil Filter.....	H-51220	MT431CP (FORKLIFTS) PERKINS 4.236 Hydraulic Oil Filter.....	H-51220	MT845T (FORKLIFTS) S/N: 1 SERIES-UP Hydraulic Oil Filter.....	H-51220
MT1233 (FORKLIFTS) S/N: 2 SERIES-UP , 1994-UP Hydraulic Oil Filter.....	H-51220	MT430CP (FORKLIFTS) Hydraulic Oil Filter.....	HC-7913	MT927 (FORKLIFTS) S/N: C SERIES-UP Hydraulic Oil Filter.....	H-51220
MT1235CP (FORKLIFTS) Hydraulic Oil Filter.....	H-51220	MT450CP (FORKLIFTS) Hydraulic Oil Filter.....	HC-7913	MT940L (FORKLIFTS) S/N: 1 SERIES-UP Hydraulic Oil Filter.....	H-51220
MT1235CP (FORKLIFTS) S/N: C SERIES-UP Hydraulic Oil Filter.....	H-51220	MT626 (FORKLIFTS) S/N: A SERIES-UP Hydraulic Oil Filter.....	H-51220	TME15 (FORKLIFTS) Hydraulic Oil Filter Return.....	H-5901
MT1330 (FORKLIFTS) S/N: 2 SERIES-UP , 1994-UP Hydraulic Oil Filter.....	H-51220	MT 728.4T (FORKLIFTS) Hydraulic Oil Filter.....	H-51220	MANITOWOC	
MT1330SL (FORKLIFTS) PERKINS , 1994-UP Hydraulic Oil Filter.....	H-51220	MT727 (FORKLIFTS) S/N: C SERIES-UP Hydraulic Oil Filter.....	H-51220	4100 (EXCAVATORS) CAT CATERPILLAR Hydraulic Oil Filter Full Flow.....	HC-7935
MT1330SL (FORKLIFTS) S/N: 1 SERIES-UP , 1994-UP Hydraulic Oil Filter.....	H-51220	MT728-2 (FORKLIFTS) S/N: 1 SERIES-UP Hydraulic Oil Filter.....	H-51220	MASSEY-FERGUSON	
MT1335SL (FORKLIFTS) S/N: 1 SERIES-UP Hydraulic Oil Filter.....	H-51220	MT835T (FORKLIFTS) PERKINS 1004-40TW Hydraulic Oil Filter.....	H-51220	148 (AGRICULTURE) 148 Hydraulic Oil Filter.....	H-5102
MT1530SCP ULTRA (FORKLIFTS) S/N: C SERIES-UP Hydraulic Oil Filter.....	H-51220	MT840CP T (FORKLIFTS) PERKINS 1004.4T Hydraulic Oil Filter.....	H-51220	165 (AGRICULTURE) 165 Hydraulic Oil Filter.....	H-5102
MT1740SLT (FORKLIFTS) 2003-UP Hydraulic Oil Filter.....	H-51220			168 (AGRICULTURE) 168 Hydraulic Oil Filter.....	H-5102



ENGINE APPLICATION

MODEL/APPLICATION	SAKURA NO	MODEL/APPLICATION	SAKURA NO	MODEL/APPLICATION	SAKURA NO
MASSEY-FERGUSON		MASSEY-FERGUSON		MASSEY-FERGUSON	
185 (AGRICULTURE) 185 Hydraulic Oil Filter.....	H-5102	6150 (TRACTORS) 1995-1999 Hydraulic Oil Filter.....	H-5001	Hydraulic Oil Filter.....	H-51170
188 (AGRICULTURE) 188 Hydraulic Oil Filter.....	H-5102	6190 (TRACTORS) 1995-1999 Hydraulic Oil Filter.....	H-5001	MF-1150 (TRACTORS) PERKINS V8-510 Hydraulic Oil Filter.....	H-51170
240 (AGRICULTURE) 240 Hydraulic Oil Filter.....	H-5102	8220 (TRACTORS) Hydraulic Oil Filter.....	H-5001	MF-1155 (TRACTORS) PERKINS V8.540 Hydraulic Oil Filter.....	H-51170
2620 (TRACTORS) Hydraulic Oil Filter.....	HC-51070	8240 (TRACTORS) Hydraulic Oil Filter.....	H-5001	MF-1500 (TRACTORS) CAT 3150 Hydraulic Oil Filter.....	H-79411
2640 (TRACTORS) Hydraulic Oil Filter.....	HC-51070	8245 (AGRICULTURE) 8245 Hydraulic Oil Filter.....	H-7916	MF-1505 (TRACTORS) CAT 3208 Hydraulic Oil Filter.....	H-79411
2680 (TRACTORS) Hydraulic Oil Filter.....	HC-51070	8245 (TRACTORS) Hydraulic Oil Filter.....	H-7916	MF-1805 (TRACTORS) CAT 3208 Hydraulic Oil Filter.....	H-79411
2720 (TRACTORS) Hydraulic Oil Filter.....	HC-51070	8260 (AGRICULTURE) 8260 Hydraulic Oil Filter.....	H-7916	MF-100 (LOADERS) Hydraulic Oil Filter.....	H-51170
3065 (TRACTORS) S/N: 095020-UP Hydraulic Oil Filter.....	HC-79081	8270 (AGRICULTURE) 8270 Hydraulic Oil Filter.....	H-7916	Hydraulic Oil Filter.....	H-51170
4233 (TRACTORS) Hydraulic Oil Filter.....	HC-5101	8270 (TRACTORS) Hydraulic Oil Filter.....	H-7916	MF-11 (LOADERS) Perkins 4.248 Hydraulic Oil Filter Transmission...	H-65030
4243 (TRACTORS) Hydraulic Oil Filter.....	HC-5101	Hydraulic Oil Filter.....	H-5001	MF-1124C (LOADERS) PERKINS T6.354.4 Hydraulic Oil Filter.....	H-51170
4263 (TRACTORS) Hydraulic Oil Filter.....	HC-5101	B6 (DOZERS) Hydraulic Oil Filter.....	H-6301	MF-1125 (TRACTORS) Hydraulic Oil Filter.....	HC-5801
4325 (TRACTORS) Hydraulic Oil Filter.....	HC-5101	K10 (DOZERS) Hydraulic Oil Filter.....	H-6301	MF-1160 (TRACTORS) Hydraulic Oil Filter.....	H-2719
4333 (TRACTORS) Hydraulic Oil Filter.....	HC-5101	K7 (DOZERS) MASSEY D941K Hydraulic Oil Filter.....	H-6301	MF-25 (COMBINES) VALMET Hydraulic Oil Filter.....	HC-7906
4335 (TRACTORS) Hydraulic Oil Filter.....	HC-5101	K7B (DOZERS) Hydraulic Oil Filter.....	H-6301	MF-25 (TRACTORS) MASSEY DIESEL Hydraulic Oil Filter.....	H-79411
4345 (TRACTORS) Hydraulic Oil Filter.....	HC-5101	K8 (DOZERS) MASSEY D941B Hydraulic Oil Filter.....	H-6301	MF-2500 (FORKLIFTS) Hydraulic Oil Filter.....	H-51170
4360 (TRACTORS) Hydraulic Oil Filter.....	HC-5101	MF-1100 (TRACTORS) MASSEY DIESEL Hydraulic Oil Filter.....	H-51170	MF-2500 (TRACTORS) MASSEY GASOLINE Hydraulic Oil Filter.....	HC-1903
6140 (TRACTORS) 1995-1999 Hydraulic Oil Filter.....	H-5001	MF-1100 (TRACTORS) MASSEY GAS Hydraulic Oil Filter.....	H-51170	Hydraulic Oil Filter.....	H-79411
		MF-1105 (TRACTORS) PERKINS T6.354 Hydraulic Oil Filter.....	H-51170	MF-2620 (TRACTORS) PERKINS A6.354 Hydraulic Oil Filter.....	HC-51070



ENGINE APPLICATION

MODEL/APPLICATION	SAKURA NO	MODEL/APPLICATION	SAKURA NO	MODEL/APPLICATION	SAKURA NO
MASSEY-FERGUSON		MASSEY-FERGUSON		MASSEY-FERGUSON	
MF-2620 (TRACTORS) PERKINS A6.354		MF-356 (TRACTORS) Hydraulic Oil Filter.....	H-79411	Hydraulic Oil Filter.....	H-51170
MF-2775 (TRACTORS) MASSEY TV8.640 Hydraulic Oil Filter.....	HC-5511	MF-360 (TRACTORS) PERKINS AT3.152.4 Hydraulic Oil Filter.....	HC-5101	MF-33 (LOADERS) Perkins 4.248 Hydraulic Oil Filter Transmission....	H-65030
MF-2775 (TRACTORS) PERKINS V8.640 Hydraulic Oil Filter.....	HC-5511	MF-3610 (TRACTORS) PERKINS 6.354.4 Hydraulic Oil Filter Transmission...	HC-51060	MF-34 (COMBINES) VALMET 612DSL (S/N: 5222-UP) Hydraulic Oil Filter.....	HC-62020
MF-200 (TRACTORS) CONTINEL Z-134 Hydraulic Oil Filter.....	H-51170	MF-362 (TRACTORS) Hydraulic Oil Filter.....	HC-5101	MF-34 (HARVESTERS) VALMET 620DSL (S/N: 4805-4804) Hydraulic Oil Filter.....	HC-62020
Hydraulic Oil Filter.....	H-79411			MF-350 (TRACTORS) Hydraulic Oil Filter.....	HC-5101
MF-200 (TRACTORS) PERKINS Hydraulic Oil Filter.....	H-51170	MF-3630 (TRACTORS) PERKINS T6.354.4 Hydraulic Oil Filter Transmission...	HC-51060	MF-3680 C146005 (TRACTORS) Hydraulic Oil Filter Transmission...	HC-51060
Hydraulic Oil Filter.....	H-79411				
MF-2200 (FORKLIFTS) PERKINS AD3.152 Hydraulic Oil Filter.....	H-79411	MF-3645 (TRACTORS) PERKINS 1006.6 TURBO , 1991 Hydraulic Oil Filter Transmission...	HC-51060	MF-38 (COMBINES) VALMET 612DSL (S/N: 5222-UP) Hydraulic Oil Filter.....	HC-62020
				MF-40 (TRACTORS) PERKINS 3.152 Hydraulic Oil Filter.....	H-79411
MF-3050 (TRACTORS) PERKINS 4.236 Hydraulic Oil Filter.....	HC-79081	MF-3655 (TRACTORS) PERKINS 1006.6 TURBO , 1991 Hydraulic Oil Filter Transmission...	HC-51060	MF-4225 (TRACTORS) PERKINS Hydraulic Oil Filter.....	HC-5101
MF-3065 (TRACTORS) PERKINS 4.236 Hydraulic Oil Filter.....	HC-79081	MF-375 (TRACTORS) Hydraulic Oil Filter Full Flow.....	HC-7935	MF-44 (LOADERS) PERKINS 6.354 Hydraulic Oil Filter Transmission....	H-65030
MF-3080 (TRACTORS) PERKINS 6.354.4 Hydraulic Oil Filter.....	HC-79081	Hydraulic Oil Filter.....	HC-5101	MF-400 (LOADERS) PERKINS A6.354 Hydraulic Oil Filter Transmission....	H-65030
		MF-383 (TRACTORS) PERKINS A4.248 Hydraulic Oil Filter.....	HC-5101	MF-400C (LOADERS) PERKINS 6.354 Hydraulic Oil Filter Transmission....	H-65030
MF-3090 (TRACTORS) PERKINS 6.354.4 Hydraulic Oil Filter.....	HC-79081			Hydraulic Oil Filter.....	H-6301
		MF-390T (TRACTORS) Hydraulic Oil Filter.....	HC-5101		
MF-3115 (TRACTORS) PERKINS 1006.6 , 1991 Hydraulic Oil Filter.....	HC-79081	Hydraulic Oil Filter Full Flow.....	HC-7935	MF-4500 (FORKLIFTS) Hydraulic Oil Filter.....	H-79411
MF-3120 (TRACTORS) Hydraulic Oil Filter Transmission..	HC-51060	MF-398 (TRACTORS) Hydraulic Oil Filter.....	HC-5101	MF-50 (LOADERS) Hydraulic Oil Filter.....	H-51170
Hydraulic Oil Filter.....	HC-79081	Hydraulic Oil Filter Full Flow.....	HC-7935		
MF-3125 (TRACTORS) PERKINS 1006.6 TURBO , 1991 Hydraulic Oil Filter Transmission..	HC-51060			MF-516 (COMBINES) Hydraulic Oil Filter.....	HC-5504
		MF-399 (TRACTORS) PERKINS A6.354.4 Hydraulic Oil Filter.....	HC-5101		
MF-3140 (TRACTORS) Hydraulic Oil Filter.....	HC-79081	Hydraulic Oil Filter Full Flow.....	HC-7935	MF-54 (LOADERS) PERKINS Hydraulic Oil Filter.....	H-79411
MF-3525 (TRACTORS) Hydraulic Oil Filter.....	HC-51070	MF-3120 F (TRACTORS) Hydraulic Oil Filter Transmission..	HC-51060	MF-55 (LOADERS) PERKINS Hydraulic Oil Filter Transmission....	H-65030
MF-356 (TRACTORS) MASSEY DIESEL Hydraulic Oil Filter.....	H-79411	MF-32 (LOADERS) Hydraulic Oil Filter.....	H-79411		
		MF-320 (TRACTORS) PERKINS A4.318			



ENGINE APPLICATION

MODEL/APPLICATION	SAKURA NO	MODEL/APPLICATION	SAKURA NO	MODEL/APPLICATION	SAKURA NO
MASSEY-FERGUSON		MASSEY-FERGUSON		MASSEY-FERGUSON	
MF-6235 (TRACTORS) PERKINS Hydraulic Oil Filter.....	H-5001	Hydraulic Oil Filter.....	H-6301	MF-8140 (TRACTORS) VALMET 634DS	Hydraulic Oil Filter..... H-5001
MF-6255 (TRACTORS) PERKINS Hydraulic Oil Filter.....	H-5001	MF-7256 (COMBINES) SISU 634DSBIE Hydraulic Oil Filter.....	HC-6801	MF-8220 (TRACTORS) Hydraulic Oil Filter.....	H-5001
MF-600C (DOZERS) Hydraulic Oil Filter.....	H-6301	MF-77 (LOADERS) CUMMINS NH250 Hydraulic Oil Filter Transmission....	H-65030	MF-8240 (TRACTORS) Hydraulic Oil Filter.....	H-5001
Hydraulic Oil Filter.....	H-6301	MF-77 (LOADERS) DETROITD 6V-71 Hydraulic Oil Filter Transmission....	H-65030	MF-8245 (TRACTORS) Hydraulic Oil Filter.....	H-7916
MF-6190 (TRACTORS) Hydraulic Oil Filter.....	H-5001	MF-77 (TRACTORS) CUMMINS Hydraulic Oil Filter.....	H-5517	MF-8270 (TRACTORS) Hydraulic Oil Filter.....	H-5001
MF-6445 (TRACTORS) PERKINS 1104C-44/T , 2003-UP Hydraulic Oil Filter.....	H-5001	Hydraulic Oil Filter Transmission....	H-65030	Hydraulic Oil Filter.....	H-7916
MF-6455 (TRACTORS) PERKINS 1104C-44/T , 2003-UP Hydraulic Oil Filter.....	H-5001	MF-77 (TRACTORS) DETROITD 8V-71N Hydraulic Oil Filter Transmission....	H-65030	MF-8570 (COMBINES) Hydraulic Oil Filter Full Flow.....	HC-79331
MF-6460 (TRACTORS) PERKINS 1104C-E44TA , 2003-UP Hydraulic Oil Filter.....	H-5001	MF-77C (TRACTORS) Hydraulic Oil Filter.....	H-6301	MF-8590 (COMBINES) Hydraulic Oil Filter.....	HC-5511
MF-6465 (TRACTORS) PERKINS 1106C-E60TA , 2003-UP Hydraulic Oil Filter.....	H-5001	MF-811 (TRACTORS) PERKINS 4.108 Hydraulic Oil Filter.....	HC-1903	MF-8680 (COMBINES) CUMMINS Hydraulic Oil Filter.....	HC-55260
MF-6475 (TRACTORS) PERKINS 1106C-E60TA , 2004-UP Hydraulic Oil Filter.....	H-5001	MF-8260 (TRACTORS) VALMET 634DSBIE , 1999-UP Hydraulic Oil Filter.....	H-7916	MF-8780 (COMBINES) CUMMINS , 2001-UP Hydraulic Oil Filter Full Flow.....	HC-79331
MF-6495 (TRACTORS) SISU 66 ETA , 2003-UP Hydraulic Oil Filter.....	H-5001	Hydraulic Oil Filter.....	H-5001	MF-8780 (COMBINES) Hydraulic Oil Filter Full Flow.....	HC-79331
MF-6497 (TRACTORS) SISU 74 CTA (S/N: DYNA-6-UP) Hydraulic Oil Filter.....	H-5001	MF-8280 (TRACTORS) VALMET 645DSBIE , 1999-UP Hydraulic Oil Filter.....	H-7916	MF-8780XP (COMBINES) CUMMINS QSC8.3 Hydraulic Oil Filter Full Flow.....	HC-79331
MF-66 (LOADERS) CUMMINS NH250 Hydraulic Oil Filter Transmission....	H-65030	Hydraulic Oil Filter.....	H-5001	MF-9240 (TRACTORS) CUMMINS 6CTA8.3 Hydraulic Oil Filter.....	HC-5508
MF-66 (LOADERS) DETROITD 6V-53 Hydraulic Oil Filter Transmission....	H-65030	MF-8170 (TRACTORS) VALMET 645TCC Hydraulic Oil Filter.....	H-5001	MASSEY-FERGUSON/HANOMAG	
MF-70 (TRACTORS) Hydraulic Oil Filter Transmission....	H-5109	MF-80 (LOADERS) PERKINS 6.354 Hydraulic Oil Filter Transmission....	H-5109	MF-33B (LOADERS) Hydraulic Oil Filter.....	H-6301
MF-70 (TRACTORS) PERKINS 4.318 Hydraulic Oil Filter Transmission....	H-5109	MF-80 (TRACTORS) Hydraulic Oil Filter Transmission....	H-5109	MF-44C (LOADERS) Hydraulic Oil Filter.....	H-6301
MF-700C (DOZERS) Hydraulic Oil Filter.....	H-6301	MF-8110 (TRACTORS) PERKINS 1006-6 THR Hydraulic Oil Filter.....	H-5001	MF66C (LOADERS) Hydraulic Oil Filter.....	H-6301
MF-700C (LOADERS) HANOMAGH 6-660 Hydraulic Oil Filter.....	H-6301	MF-8140 (TRACTORS) VALMET 620DS Hydraulic Oil Filter.....	H-5001	MF-77C (LOADERS) Hydraulic Oil Filter.....	H-6301



ENGINE APPLICATION

MODEL/APPLICATION	SAKURA NO	MODEL/APPLICATION	SAKURA NO	MODEL/APPLICATION	SAKURA NO
MASSEY-FERGUSON/HANOMAG		MELROE-BOBCAT EXCAVATORS		MELROE-BOBCAT EXCAVATORS	
MF-88 (LOADERS)		Hydraulic Oil Filter.....	HC-7932	Hydraulic Oil Filter.....	HC-7932
Hydraulic Oil Filter Transmission...	H-65030	530 (CONSTRUCTION & MINING) KOHLER K-582S		641 (CONSTRUCTION & MINING)	
MFC44C (COMPACTORS)		Hydraulic Oil Filter.....	HC-7932	Hydraulic Oil Filter.....	HC-7932
Hydraulic Oil Filter.....	H-6301	530 (CONSTRUCTION & MINING)		642 (CONSTRUCTION & MINING) FORD 4 CYL-98	
MFC66C (COMPACTORS)		Hydraulic Oil Filter.....	HC-7932	Hydraulic Oil Filter.....	HC-7932
Hydraulic Oil Filter.....	H-6301	533 (CONSTRUCTION & MINING) ISUZU 2AA1		642 (CONSTRUCTION & MINING)	
W450C (SHOVELS)		Hydraulic Oil Filter.....	HC-7932	Hydraulic Oil Filter.....	HC-7932
Hydraulic Oil Filter.....	H-6301	540 (CONSTRUCTION & MINING) KOHLER K-582S		643 (CONSTRUCTION & MINING) KUBOTA D1402-B	
MATBRO		Hydraulic Oil Filter.....	HC-7932	Hydraulic Oil Filter.....	HC-7932
TELERAM C (FORKLIFTS)		540 (CONSTRUCTION & MINING)		643 (CONSTRUCTION & MINING)	
Hydraulic Oil Filter Transmission....	H-5109	Hydraulic Oil Filter.....	HC-7932	Hydraulic Oil Filter.....	HC-7932
TR250 POWERSHIFT PLUS (FORKLIFTS)		543 (CONSTRUCTION & MINING) ISUZU 2AA1 11999		700 (CONSTRUCTION & MINING)	
Hydraulic Oil Filter.....	HC-7913	Hydraulic Oil Filter.....	HC-7932	Hydraulic Oil Filter.....	HC-7932
MECALAC/PELJOP		600 (CONSTRUCTION & MINING) DEUTZ 410		700 (CONSTRUCTION & MINING) WISCONSIN VH-4D	
12MXT (LOADERS)		Hydraulic Oil Filter.....	HC-7932	Hydraulic Oil Filter.....	HC-7932
Hydraulic Oil Filter.....	H-7602	620 (CONSTRUCTION & MINING)		720 (CONSTRUCTION & MINING)	
MELROE-BOBCAT EXCAVATORS		Hydraulic Oil Filter.....	HC-7932	Hydraulic Oil Filter.....	HC-7932
1075 (CONSTRUCTION & MINING) JDEERE 4-276		620 (CONSTRUCTION & MINING) WISCONSIN VH-4D		720 (CONSTRUCTION & MINING) WISCONSIN VH-4D	
Hydraulic Oil Filter.....	HC-7932	Hydraulic Oil Filter.....	HC-7932	Hydraulic Oil Filter.....	HC-7932
2000 (CONSTRUCTION & MINING) 2000		630 (CONSTRUCTION & MINING)		721 (CONSTRUCTION & MINING) DEUTZ F2L411	
Hydraulic Oil Filter.....	HC-7932	Hydraulic Oil Filter.....	HC-7932	Hydraulic Oil Filter.....	HC-7932
225 To S/N 11999 (EXCAVATORS) W/KUBOTA ENG.		630 (CONSTRUCTION & MINING) WISCONSIN VH-4D		721 (CONSTRUCTION & MINING)	
Hydraulic Oil Filter additional part..	H-7105	Hydraulic Oil Filter.....	HC-7932	Hydraulic Oil Filter.....	HC-7932
231 To S/N 11999 (EXCAVATORS) W/KUBOTA ENG.		631 (CONSTRUCTION & MINING) DEUTZ 411		722 (CONSTRUCTION & MINING) FORD L4-98	
Hydraulic Oil Filter additional part..	H-7105	Hydraulic Oil Filter.....	HC-7932	Hydraulic Oil Filter.....	HC-7932
310 (CONSTRUCTION & MINING) KOHLER 321-S		631 (CONSTRUCTION & MINING) DEUTZ 511		722 (CONSTRUCTION & MINING)	
Hydraulic Oil Filter.....	HC-7932	Hydraulic Oil Filter.....	HC-7932	Hydraulic Oil Filter.....	HC-7932
310 (CONSTRUCTION & MINING) KOHLER K-341-QS GAS		631 (CONSTRUCTION & MINING) DEUTZ F2L411D		730 (CONSTRUCTION & MINING)	
Hydraulic Oil Filter.....	HC-7932	Hydraulic Oil Filter.....	HC-7932	Hydraulic Oil Filter.....	HC-7932
310 (CONSTRUCTION & MINING)		632 (CONSTRUCTION & MINING) FORD 14-98		731 (CONSTRUCTION & MINING) DEUTZ 411	
Hydraulic Oil Filter.....	HC-7932	Hydraulic Oil Filter.....	HC-7932	Hydraulic Oil Filter.....	HC-7932
313 (CONSTRUCTION & MINING)		632 (CONSTRUCTION & MINING)		731 (CONSTRUCTION & MINING) DEUTZ 511	
Hydraulic Oil Filter.....	HC-7932	Hydraulic Oil Filter.....	HC-7932	Hydraulic Oil Filter.....	HC-7932
520 (CONSTRUCTION & MINING)		641 (CONSTRUCTION & MINING) DEUTZ F2L511		731 (CONSTRUCTION & MINING) DEUTZ DEUTZ	



ENGINE APPLICATION

MODEL/APPLICATION	SAKURA NO	MODEL/APPLICATION	SAKURA NO	MODEL/APPLICATION	SAKURA NO
MELROE-BOBCAT EXCAVATORS		MERCEDES-BENZ		MORBARK	
731 (CONSTRUCTION & MINING) DEUTZ DEUTZ Hydraulic Oil Filter.....	HC-7932	O 405 (BUSES) MERCEDES OM447HLA , 1986-UP Hydraulic Oil Filter Transmission....	H-7102	RSI TUBGRINDER (CHIPPERS) CUMMINS KTA-19C Hydraulic Oil Filter Full Flow.....	HC-79331
732 (CONSTRUCTION & MINING) Hydraulic Oil Filter.....	HC-7932	O 405 (BUSES) MERCEDES OM447H , 1986-UP Hydraulic Oil Filter Transmission....	H-7102	RSI TUBGRINDER (CHIPPERS) CUMMINS KT-19 Hydraulic Oil Filter Full Flow.....	HC-79331
741 (CONSTRUCTION & MINING) DEUTZ F2L511 Hydraulic Oil Filter.....	HC-7932	O 405 (BUSES) MERCEDES OM447HA , 1986-UP Hydraulic Oil Filter Transmission....	H-7102	MOXY	
741 (CONSTRUCTION & MINING) Hydraulic Oil Filter.....	HC-7932	MERTZ		6200S (DUMP TRUCKS) SCANIA Hydraulic Oil Filter.....	HC-6802
742 (CONSTRUCTION & MINING) Hydraulic Oil Filter.....	HC-7932	M4250 (SPRAYERS) CAT 3208B Hydraulic Oil Filter.....	HC-5511	D155 (DUMP TRUCKS) SCANIA Hydraulic Oil Filter.....	H-42020
743 (CONSTRUCTION & MINING) KUBOTA V1702 Hydraulic Oil Filter.....	HC-7932	Hydraulic Oil Filter Full Flow.....	HC-79331	DD130 (DUMP TRUCKS) CUMMINS 6B5.9 Hydraulic Oil Filter.....	HC-57030
743 (CONSTRUCTION & MINING) Hydraulic Oil Filter.....	HC-7932	MERLO		MT30XT (DUMP TRUCKS) SCANIA DCS9-47 Hydraulic Oil Filter Transmission...	HC-2701
974 (CONSTRUCTION & MINING) Hydraulic Oil Filter.....	HC-7932	DBM2000XS (CONCRETE MIXERS) Hydraulic Oil Filter.....	HC-7906	MUIR HILL	
975 (CONSTRUCTION & MINING) Hydraulic Oil Filter.....	HC-7932	DBM2500EU (CONCRETE MIXERS) PERKINS (S/N: 8211552-UP) Hydraulic Oil Filter.....	HC-7906	A5000 (LOADERS) FORD 2714E Hydraulic Oil Filter Transmission...	H-65030
980 (CONSTRUCTION & MINING) Hydraulic Oil Filter.....	HC-7932	DBM2500EV (CONCRETE MIXERS) Hydraulic Oil Filter.....	HC-7906	F4000 (LOADERS) FORD 2701E Hydraulic Oil Filter Transmission...	H-65030
MERCEDES-BENZ		P26.6 EVT (HANDLER TELESCOPIC) 1998-UP Hydraulic Oil Filter.....	HC-57020	MULTIHOE	
0408 (BUSES) MERCEDES OM447HA , 1991-UP Hydraulic Oil Filter Transmission....	H-7102	P28.7 EVT (HANDLER TELESCOPIC) PERKINS 1004-40T Hydraulic Oil Filter.....	HC-57020	LDA-9044A (BACKHOES) DETROITD 3-53 Hydraulic Oil Filter Transmission...	H-65030
CONECTO C (BUSES) MERCEDES OM457.942HLA , 2003-UP Hydraulic Oil Filter Transmission....	H-7102	P28.7 KT (HANDLER TELESCOPIC) PERKINS , 2004-UP Hydraulic Oil Filter.....	HC-7906	NEW HOLLAND(CNH)	
CONECTO C (BUSES) MERCEDES OM457HLA , 2001-UP Hydraulic Oil Filter Transmission....	H-7102	P30.11 XS (HANDLER TELESCOPIC) PERKINS Hydraulic Oil Filter.....	HC-7906	1052 STACK RETRIEVER (BALERS) Hydraulic Oil Filter Full Flow.....	HC-7901
CONECTO C (BUSES) MERCEDES OM906.960LA , 2001-UP Hydraulic Oil Filter Transmission....	H-7102	P30.7 EVX (HANDLER TELESCOPIC) Hydraulic Oil Filter.....	HC-57020	1085 (BALERS) FORD 401 Hydraulic Oil Filter.....	HC-5511
CONECTO C (BUSES) MERCEDES OM447HLA , 1998-UP Hydraulic Oil Filter Transmission....	H-7102	MITSUBISHI		1089 (BALERS) NEW HOLLAND , 1994-UP Hydraulic Oil Filter.....	HC-5511
CONECTO G (BUSES) MERCEDES OM447HLA , 1999-UP Hydraulic Oil Filter Transmission....	H-7102	MG100 (GRADERS) Hydraulic Oil Filter.....	H-7956	1118 (WINDROWERS) FORD 268 Hydraulic Oil Filter.....	HC-7925
MERCEDES-BENZ		MS120-8 (CONSTRUCTION EQUIPMENTS) MITSUBISHI 6D14C Hydraulic Oil Filter.....	H-5609	1180 (TRACTORS) Hydraulic Oil Filter.....	HC-45110
MERCEDES-BENZ		MORBARK		1280 (TRACTORS) Hydraulic Oil Filter.....	HC-45110
MERCEDES-BENZ		16 CHIPARVESTER (CHIPPERS) CAT 3208 Hydraulic Oil Filter.....	HC-5511		



ENGINE APPLICATION

MODEL/APPLICATION	SAKURA NO	MODEL/APPLICATION	SAKURA NO	MODEL/APPLICATION	SAKURA NO
NEW HOLLAND(CNH)		NEW HOLLAND(CNH)		NEW HOLLAND(CNH)	
1380 (TRACTORS)		Hydraulic Oil Filter.....	H-51170	4030 (TRACTORS) NEW HOLLAND 179 CID	
Hydraulic Oil Filter.....	HC-45110	Hydraulic Oil Filter Full Flow.....	HC-7901	Hydraulic Oil Filter.....	HC-45110
1400 (COMBINES) FORD 2715E , 1974-1978		2205S (AGRICULTURE) DAF DAF		4130 (TRACTORS)	
Hydraulic Oil Filter.....	H-51170	Hydraulic Oil Filter.....	HC-7906	Hydraulic Oil Filter Transmission...	HC-1902
1400 (COMBINES) FORD 6-300 , 1974-1978		2205S (WINDROWERS) DAF		4230 (TRACTORS) NEW HOLLAND 220 CID	
Hydraulic Oil Filter.....	H-51170	Hydraulic Oil Filter Full Flow.....	HC-7901	Hydraulic Oil Filter.....	HC-45110
1400 (COMBINES) FORD 2715E		Hydraulic Oil Filter.....	HC-7906	455C (EQUIPMENT)	
Hydraulic Oil Filter.....	H-51170	2305 (AGRICULTURE) DAF DAF		Hydraulic Oil Filter Full Flow.....	HC-7901
1475 (WINDROWERS) 1996-UP		Hydraulic Oil Filter.....	HC-7906	Hydraulic Oil Filter.....	H-5001
Hydraulic Oil Filter.....	HC-5511	2405 (AGRICULTURE) DAF DAF		4630 (TRACTORS) NEW HOLLAND , 1994-1999	
1496 (WINDROWERS) PERKINS 4.236		Hydraulic Oil Filter.....	HC-7906	Hydraulic Oil Filter Transmission...	HC-1902
Hydraulic Oil Filter.....	HC-7925	2450 (WINDROWERS) FORD 304		4630 (TRACTORS) NEW HOLLAND 210 CID	
1499 (BALERS)		Hydraulic Oil Filter.....	HC-5511	Hydraulic Oil Filter Transmission...	HC-1902
Hydraulic Oil Filter.....	HC-7925	250C (TRACTORS)		499 (WINDROWERS) 1983-UP	
1500 (COMBINES) CAT 3150 , 1973-1977		Hydraulic Oil Filter Full Flow.....	HC-7901	Hydraulic Oil Filter Full Flow.....	HC-7901
Hydraulic Oil Filter.....	H-51170	Hydraulic Oil Filter Transmission...	HC-1902	5110 (EQUIPMENT) NEW HOLLAND DIESEL	
1580T (TRACTORS)		3010S (TRACTORS) 1994-UP		Hydraulic Oil Filter Transmission...	HC-1902
Hydraulic Oil Filter.....	HC-45110	Hydraulic Oil Filter.....	HC-45110	545C (EQUIPMENT)	
180-90 (TRACTORS)		3230 (EQUIPMENT)		Hydraulic Oil Filter Full Flow.....	HC-7901
Hydraulic Oil Filter.....	HC-45110	Hydraulic Oil Filter Transmission...	HC-1902	55-46 (TRACTORS)	
1880 (TRACTORS)		340 (CONSTRUCTION & MINING)		Hydraulic Oil Filter.....	HC-45110
Hydraulic Oil Filter.....	HC-45110	Hydraulic Oil Filter.....	HC-7932	55-56 (TRACTORS)	
1880 CROP CRUISER (EQUIPMENT) CAT 3150		3430 (EQUIPMENT)		Hydraulic Oil Filter.....	HC-45110
Hydraulic Oil Filter.....	H-51170	Hydraulic Oil Filter Transmission...	HC-1902	555E (LOADERS) FORD , 1997-2000	
1880 CROP CRUISER (EQUIPMENT) FORD 391 GAS		345D (TRACTORS)		Hydraulic Oil Filter.....	HC-5506
Hydraulic Oil Filter.....	H-51170	Hydraulic Oil Filter Full Flow.....	HC-7901	Hydraulic Oil Filter.....	HC-7001
1900 (EQUIPMENT) CAT 3306		345C (EQUIPMENT)		555D (LOADERS) S/N: 09-1993-UP	
Hydraulic Oil Filter.....	H-51170	Hydraulic Oil Filter Full Flow.....	HC-7901	Hydraulic Oil Filter.....	HC-5506
1900 (EQUIPMENT) NEW HOLLAND DIESEL		3830 (TRACTORS)		555C (EQUIPMENT)	
Hydraulic Oil Filter Full Flow.....	HC-7901	Hydraulic Oil Filter.....	HC-45110	Hydraulic Oil Filter.....	H-5001
1915 (WINDROWERS) CAT 3306		3930 (TRACTORS) NEW HOLLAND , 1998-1999		Hydraulic Oil Filter Full Flow.....	HC-7901
Hydraulic Oil Filter.....	H-51170	Hydraulic Oil Filter Transmission...	HC-1902	5610S (TRACTORS) NH 4/268 , 1994	
Hydraulic Oil Filter Full Flow.....	HC-7901	3930 (TRACTORS)		Hydraulic Oil Filter.....	HC-45040
2115 (EQUIPMENT) CAT 3406		Hydraulic Oil Filter Transmission...	HC-1902	5640 (AGRICULTURE) NEWHOLLA 4.4L 4 CYL , 1992	
				Hydraulic Oil Filter.....	HC-1905



ENGINE APPLICATION

MODEL/APPLICATION	SAKURA NO	MODEL/APPLICATION	SAKURA NO	MODEL/APPLICATION	SAKURA NO
NEW HOLLAND(CNH)		NEW HOLLAND(CNH)		NEW HOLLAND(CNH)	
5640 (EQUIPMENT) NEW HOLLAND 4.4L 4 CYL , 1992		675D (LOADERS) S/N: 9-1992-8-1993		7840 (TRACTORS) NEW HOLLAND 6.6L 6CYL , 1992	
Hydraulic Oil Filter.....	HC-1905	Hydraulic Oil Filter.....	HC-5506	Hydraulic Oil Filter.....	HC-76080
Hydraulic Oil Filter.....	HC-76080			Hydraulic Oil Filter.....	HC-1905
5640 SL (TRACTORS)		675D (LOADERS) S/N: 9-1993-UP		Hydraulic Oil Filter.....	HC-5504
Hydraulic Oil Filter.....	HC-1905	Hydraulic Oil Filter.....	HC-5506	7910 (AGRICULTURE) 7910	
5640 SLE (TRACTORS)		6810 (EQUIPMENT)		Hydraulic Oil Filter Transmission...	HC-1902
Hydraulic Oil Filter.....	HC-1905	Hydraulic Oil Filter Transmission...	HC-1902	7910 (AGRICULTURE) NEWHOLLA 6 CYL	
566 (TRACTORS)		70-56 (TRACTORS)		Hydraulic Oil Filter Transmission...	HC-1901
Hydraulic Oil Filter.....	HC-45110	Hydraulic Oil Filter.....	HC-45110	7910 (EQUIPMENT) NEW HOLLAND 6 CYL DIESEL	
570 (TRACTORS)		70-76 DT (TRACTORS)		Hydraulic Oil Filter Transmission...	HC-1902
Hydraulic Oil Filter.....	HC-45110	Hydraulic Oil Filter.....	HC-45110	8010 (TRACTORS) NEW HOLLAND , 1996-UP	
575E (LOADERS) FORD , 1997-2000		7530 (TRACTORS) NEW HOLLAND 331 CID		Hydraulic Oil Filter Transmission...	HC-1902
Hydraulic Oil Filter.....	HC-7001	Hydraulic Oil Filter.....	HC-45110	Hydraulic Oil Filter.....	HC-1905
575D (LOADERS) S/N: 09-1992-08-1993		755 (EQUIPMENT)		8160 (TRACTORS) NEW HOLLAND , 1995-2000	
Hydraulic Oil Filter.....	HC-5506	Hydraulic Oil Filter Transmission....	H-5109	Hydraulic Oil Filter.....	HC-1905
575D (LOADERS) S/N: 09-1993-UP		Hydraulic Oil Filter.....	HC-1903	Hydraulic Oil Filter.....	HC-5504
Hydraulic Oil Filter.....	HC-5506	7610S (TRACTORS) NEW HOLLAND , 1994-UP		8160 (TRACTORS) NEW HOLLAND , 1995-2000	
60-56 (TRACTORS)		Hydraulic Oil Filter Transmission...	HC-1902	Hydraulic Oil Filter.....	HC-5504
Hydraulic Oil Filter.....	HC-45110	766 (TRACTORS)		8160 (AGRICULTURE)	
6410 (EQUIPMENT) FORD 256 DIESEL		Hydraulic Oil Filter.....	HC-45110	Hydraulic Oil Filter.....	HC-1905
Hydraulic Oil Filter Transmission...	HC-1902	7740 (AGRICULTURE) NEWHOLLA 304 CID TURBO		8210 (AGRICULTURE) 8210	
655 (EQUIPMENT)		Hydraulic Oil Filter.....	HC-1905	Hydraulic Oil Filter Transmission...	HC-1902
Hydraulic Oil Filter Full Flow.....	HC-7901	7740 (TRACTORS) NEW HOLLAND 304 CID TURBO		8240 (AGRICULTURE) 1996	
Hydraulic Oil Filter.....	H-5001	Hydraulic Oil Filter.....	HC-5504	Hydraulic Oil Filter.....	HC-1905
655 (LOADERS) NEW HOLLAND 4CYL		Hydraulic Oil Filter.....	HC-76080	Hydraulic Oil Filter.....	HC-1905
Hydraulic Oil Filter Full Flow.....	HC-7901	Hydraulic Oil Filter.....	HC-1905	Hydraulic Oil Filter.....	HC-5504
Hydraulic Oil Filter.....	H-5001	7740SLE (AGRICULTURE) NEWHOLLA 304 CID TURBO		8240 SLE (AGRICULTURE) 8240 SLE	
655E (LOADERS) FORD , 1997-2000		Hydraulic Oil Filter.....	HC-1905	Hydraulic Oil Filter.....	HC-5504
Hydraulic Oil Filter.....	HC-7001	7810 (AGRICULTURE) 7810		8240 SLE (TRACTORS)	
655D (LOADERS)		Hydraulic Oil Filter.....	HC-1905	Hydraulic Oil Filter.....	HC-1905
Hydraulic Oil Filter.....	HC-5506	Hydraulic Oil Filter Transmission...	HC-1902	8240 SL (TRACTORS)	
666 (TRACTORS)		7810 (AGRICULTURE)		Hydraulic Oil Filter.....	HC-1905
Hydraulic Oil Filter.....	HC-45110	Hydraulic Oil Filter.....	HC-1905	8260 (AGRICULTURE) 8260	
675E (LOADERS) FORD , 1997-2000		Hydraulic Oil Filter.....	HC-1905	Hydraulic Oil Filter.....	HC-5504
Hydraulic Oil Filter.....	HC-7001	7840 (AGRICULTURE) NEWHOLLA 6.6L 6 CYL , 1992		8260 (AGRICULTURE)	
		Hydraulic Oil Filter.....	HC-1905	Hydraulic Oil Filter.....	HC-1905



ENGINE APPLICATION

MODEL/APPLICATION	SAKURA NO	MODEL/APPLICATION	SAKURA NO	MODEL/APPLICATION	SAKURA NO
NEW HOLLAND(CNH)		NEW HOLLAND(CNH)		NEW HOLLAND(CNH)	
8340 (TRACTORS) NEW HOLLAND 7.5L 6CYL , 1992		Hydraulic Oil Filter.....	HC-5504	FR9050 (HARVESTERS) IVECO CURSOR 13 , 2007-UP	
Hydraulic Oil Filter.....	HC-5504	Hydraulic Oil Filter.....	HC-5508	Hydraulic Oil Filter.....	HC-5504
Hydraulic Oil Filter.....	HC-1905	CR960 (COMBINES) NEW HOLLAND 6/10.3L , 2001-UP		FR9060 (HARVESTERS) IVECO CURSOR 13 , 2007-UP	
8360 (AGRICULTURE)		Hydraulic Oil Filter.....	HC-5508	Hydraulic Oil Filter.....	HC-5504
Hydraulic Oil Filter.....	HC-1905	Hydraulic Oil Filter.....	HC-5504	FR9080 (HARVESTERS) CAT ACERT C18 , 2007-UP	
8530 (AGRICULTURE)		CR960 (COMBINES) NEW HOLLAND 6/7.8L , 2001-UP		Hydraulic Oil Filter.....	HC-5504
Hydraulic Oil Filter Transmission...	HC-1901	Hydraulic Oil Filter.....	HC-5508	FR9090 (HARVESTERS) IVECO VECTOR V8 , 2007-UP	
8530 (EQUIPMENT)		Hydraulic Oil Filter.....	HC-5504	Hydraulic Oil Filter.....	HC-5504
Hydraulic Oil Filter Transmission...	HC-1902	CS 640 (COMBINES) IVECO , 2002-UP		FX30 (WINDROWERS) IVECO CURSOR 10 , 2002-UP	
8560 (AGRICULTURE)		Hydraulic Oil Filter.....	HC-5508	Hydraulic Oil Filter.....	HC-7906
Hydraulic Oil Filter.....	HC-1905	CS 640 (COMBINES) 2002-UP		FX375 (WINDROWERS) IVECO 8210 (S/N: 375 HP-UP) , 1994-UP	
8670 (TRACTORS) NEW HOLLAND 456 CID , 1999-2000		Hydraulic Oil Filter.....	HC-5508	Hydraulic Oil Filter.....	HC-7906
Hydraulic Oil Filter.....	HC-5506	CS 660 (HARVESTERS) 2005-UP		FX450 (WINDROWERS) FIAT 8210 SRI (S/N: 450 HP-UP)	
8670 (TRACTORS) NEW HOLLAND , 1993-1999		Hydraulic Oil Filter.....	HC-5508	Hydraulic Oil Filter.....	HC-7906
Hydraulic Oil Filter.....	HC-5506	CX720 (COMBINES) IVECO CURSOR , 2001-UP		G170 (TRACTORS)	
Hydraulic Oil Filter.....	HC-5504	Hydraulic Oil Filter.....	HC-5504	Hydraulic Oil Filter.....	HC-45110
8670A (TRACTORS) NEW HOLLAND , 2000-UP		Hydraulic Oil Filter.....	HC-76080	Hydraulic Oil Filter.....	HC-5506
Hydraulic Oil Filter.....	HC-5506	CX8080 (COMBINES) IVECO CURSOR 9 (S/N: 8.7L-UP) , 2007-UP		H9870 (BALERS) 2007-UP	
8730 (AGRICULTURE)		Hydraulic Oil Filter.....	HC-5504	Hydraulic Oil Filter.....	HC-5511
Hydraulic Oil Filter Transmission...	HC-1901	CX8090 (COMBINES) IVECO CURSOR 10 (S/N: 10.3L-UP) , 2006-UP		HW345 (WINDROWERS) NEW HOLLAND , 2004-UP	
8730 (EQUIPMENT)		Hydraulic Oil Filter.....	HC-5504	Hydraulic Oil Filter.....	HC-5511
Hydraulic Oil Filter Transmission...	HC-1902	CX840 (COMBINES) FORD		HW300 (WINDROWERS) NEW HOLLAND , 1998-2005	
BW28 (BALERS) NEW HOLLAND , 2003-UP		Hydraulic Oil Filter.....	HC-76080	Hydraulic Oil Filter.....	HC-5511
Hydraulic Oil Filter.....	HC-5511	Hydraulic Oil Filter.....	HC-5508	HW305 (WINDROWERS) NEW HOLLAND , 2004-UP	
CR9060 (COMBINES) 2006-UP		CX860 (COMBINES) NEW HOLLAND 6/10.3L , 2001-UP		Hydraulic Oil Filter.....	HC-5511
Hydraulic Oil Filter.....	HC-5508	Hydraulic Oil Filter.....	HC-5508	HW340 (WINDROWERS) NEW HOLLAND , 1998-2007	
Hydraulic Oil Filter.....	HC-5504	Hydraulic Oil Filter.....	HC-5504	Hydraulic Oil Filter.....	HC-5511
CR9070 (COMBINES) IVECO CURSOR 10		CX860 (COMBINES) NEW HOLLAND 6/7.8L , 2001-UP		L120 (LOADERS) KOHLER 18 HP	
Hydraulic Oil Filter.....	HC-5508	Hydraulic Oil Filter.....	HC-5508	Hydraulic Oil Filter.....	HC-7925
Hydraulic Oil Filter.....	HC-5504	Hydraulic Oil Filter.....	HC-5504	L125 (LOADERS) NEW HOLLAND NH673	
CR9080 (COMBINES) 2006-UP		D180 (DOZERS) S/N: TIER III-UP , 2006-UP		Hydraulic Oil Filter.....	HC-7925
Hydraulic Oil Filter.....	HC-5504	Hydraulic Oil Filter.....	H-85560	L225 (EQUIPMENT) WISCONSIN TJD	
CR9090 (COMBINES) IVECO CURSOR 13 , 2008-UP		Hydraulic Oil Filter.....	HC-5508	Hydraulic Oil Filter.....	HC-5511
Hydraulic Oil Filter.....	HC-5504	F100 (TRACTORS)		L225 (LOADERS)	
CR920 (COMBINES) NEW HOLLAND , 2001-UP		Hydraulic Oil Filter.....	HC-5504	Hydraulic Oil Filter.....	HC-5511
Hydraulic Oil Filter.....	HC-5504	FR9040 (HARVESTERS) IVECO CURSOR 10 , 2007-UP		L225 (LOADERS)	
		Hydraulic Oil Filter.....	HC-5504		



ENGINE APPLICATION

MODEL/APPLICATION	SAKURA NO	MODEL/APPLICATION	SAKURA NO	MODEL/APPLICATION	SAKURA NO
NEW HOLLAND(CNH)		NEW HOLLAND(CNH)		NEW HOLLAND(CNH)	
L225 (LOADERS)		L555D (LOADERS) KUBOTA V1902B		LB115 (EQUIPMENT) NEW HOLLAND , 1998-2003	
Hydraulic Oil Filter.....	HC-5511	Hydraulic Oil Filter.....	HC-7925	Hydraulic Oil Filter.....	HC-5506
L-250 (EQUIPMENT) ONAN ONAN (S/N 736385-UP)		Hydraulic Oil Filter.....	HC-5511	Hydraulic Oil Filter.....	HC-7001
Hydraulic Oil Filter.....	HC-7925	L-553 (LOADERS)		LB115.B (CONSTRUCTION EQUIPMENTS) 1998-2004	
L-250 (EQUIPMENT) ONAN ONAN (TO S/N 736384)		Hydraulic Oil Filter.....	HC-5511	Hydraulic Oil Filter.....	HC-5506
Hydraulic Oil Filter.....	HC-7925	Hydraulic Oil Filter.....	HC-7925	LB75.B 31044850 (EQUIPMENT) NEW HOLLAND , 1998-2003	
L-250 (LOADERS) ONAN B43G		Hydraulic Oil Filter.....	HC-5511	Hydraulic Oil Filter.....	HC-7001
Hydraulic Oil Filter.....	HC-7925	L-600 (LOADERS) ONAN L-423		LB75.B 31044851 (EQUIPMENT) NEW HOLLAND , 2003	
L-250 (LOADERS) ONAN P218G		Hydraulic Oil Filter.....	HC-7925	Hydraulic Oil Filter.....	HC-7001
Hydraulic Oil Filter.....	HC-7925	Hydraulic Oil Filter.....	HC-5511	LB75 (LOADERS) 2000-2001	
L255 (LOADERS) NEW HOLLAND ISM E673 DSL		L775 (LOADERS) DEUTZ F3L912		Hydraulic Oil Filter.....	HC-5506
Hydraulic Oil Filter.....	HC-7925	Hydraulic Oil Filter.....	H-5405	LB75.B (EQUIPMENT) NEW HOLLAND (S/N: 31044851-UP) , 2003-UP	
L-325 (EQUIPMENT)		L-778 (LOADERS) FORD		Hydraulic Oil Filter.....	HC-5506
Hydraulic Oil Filter.....	HC-5511	Hydraulic Oil Filter.....	HC-7925	LB90 (EQUIPMENT) NEW HOLLAND , 1998-2003	
Hydraulic Oil Filter.....	HC-5511	L-779 (LOADERS) PERKINS 4.203		Hydraulic Oil Filter.....	HC-7001
L35 (LOADERS) DEUTZ F3L912		Hydraulic Oil Filter.....	HC-5511	LM1333 TURBO (HANDLER TELESCOPIC) C.N.H F4GE0454C*D , 2005-UP	
Hydraulic Oil Filter.....	H-5405	Hydraulic Oil Filter.....	HC-7925	Hydraulic Oil Filter.....	HC-5506
L35 (LOADERS) WISCONSIN VG-4D		L-781 (LOADERS) DEUTZ F3L912		LM1333 TURBO (HANDLER TELESCOPIC) CASE NEW HOLLAND F4GE0454C D , 2005	
Hydraulic Oil Filter.....	H-5405	Hydraulic Oil Filter.....	HC-7925	Hydraulic Oil Filter.....	HC-7001
L451 (LOADERS) DEUTZ F2L511		Hydraulic Oil Filter.....	HC-5511	LM1440 (HANDLER TELESCOPIC) IVECO , 2002	
Hydraulic Oil Filter.....	HC-5511	L-783 (LOADERS) FORD BSD333		Hydraulic Oil Filter.....	HC-7001
L454 (LOADERS) CONTINEL TM13 GAS		Hydraulic Oil Filter.....	HC-7925	LM1745 (HANDLER TELESCOPIC) C.N.H F4GE0484G*D , 2007-UP	
Hydraulic Oil Filter.....	HC-5511	Hydraulic Oil Filter.....	HC-5511	Hydraulic Oil Filter.....	HC-5506
Hydraulic Oil Filter.....	HC-7925	L-783 (LOADERS) PERKINS 4.2032		LM1745 (HANDLER TELESCOPIC) CASE NEW HOLLAND F4GE0484G D , 2007	
L454 (LOADERS) FORD V5G-411 GAS		Hydraulic Oil Filter.....	HC-7925	Hydraulic Oil Filter.....	HC-7001
Hydraulic Oil Filter.....	HC-5511	Hydraulic Oil Filter.....	HC-5511	LM1060 (HANDLER TELESCOPIC) 2008-UP	
Hydraulic Oil Filter.....	HC-7925	L-784 (LOADERS) FORD 200 GAS		Hydraulic Oil Filter.....	HC-5506
L455 (LOADERS) KUBOTA B1402B		Hydraulic Oil Filter.....	HC-5511	LM1133 (HANDLER TELESCOPIC) 2007-UP	
Hydraulic Oil Filter.....	HC-5511	Hydraulic Oil Filter.....	HC-7925	Hydraulic Oil Filter.....	HC-5506
Hydraulic Oil Filter.....	HC-7925	L-785 (LOADERS) FORD BSD333		LM1330 (HANDLER TELESCOPIC) 2005-UP	
L-452 (LOADERS) WISCONSIN VH4D		Hydraulic Oil Filter.....	HC-5511	Hydraulic Oil Filter.....	HC-5506
Hydraulic Oil Filter.....	HC-5511	Hydraulic Oil Filter.....	HC-7925	LM1340 (HANDLER TELESCOPIC) 2005-UP	
L554 (LOADERS) CONTINEL TM20 GAS		L-785 (LOADERS) PERKINS 4.2032		Hydraulic Oil Filter.....	HC-5506
Hydraulic Oil Filter.....	HC-7925	Hydraulic Oil Filter.....	HC-7925	LM1445 (HANDLER TELESCOPIC) 2005-UP	
Hydraulic Oil Filter.....	HC-5511	Hydraulic Oil Filter.....	HC-5511		
		LB110 (EQUIPMENT) NEW HOLLAND , 1998-2003			
		Hydraulic Oil Filter.....	HC-7001		



ENGINE APPLICATION

MODEL/APPLICATION	SAKURA NO	MODEL/APPLICATION	SAKURA NO	MODEL/APPLICATION	SAKURA NO
NEW HOLLAND(CNH)		NEW HOLLAND(CNH)		NEW HOLLAND(CNH)	
LM1445 (HANDLER TELESCOPIC) 2005-UP Hydraulic Oil Filter.....	HC-5506	Hydraulic Oil Filter.....	HC-1905	Hydraulic Oil Filter.....	HC-5504
LM410 (HANDLER TELESCOPIC) IVECO 8045.05 Hydraulic Oil Filter.....	H-51220	M427 (HANDLER TELESCOPIC) IVECO Hydraulic Oil Filter.....	HC-7001	T6030 (TRACTORS) NEW HOLLAND 6.75L TURBO TIER 3 , 2007-UP Hydraulic Oil Filter.....	HC-1905
LM430 (HANDLER TELESCOPIC) IVECO 8045.25 , 1998 Hydraulic Oil Filter.....	H-51220	Hydraulic Oil Filter.....	HC-5506	Hydraulic Oil Filter.....	HC-5504
LM640 (HANDLER TELESCOPIC) IVECO 8045.25 , 1998 Hydraulic Oil Filter.....	H-51220	M428 (HANDLER TELESCOPIC) IVECO Hydraulic Oil Filter.....	HC-7001	T6050 (TRACTORS) NEW HOLLAND 6.75L TURBO TIER 3 , 2007-UP Hydraulic Oil Filter.....	HC-5504
LM732 (HANDLER TELESCOPIC) S/N: TIER III-UP , 2008-UP Hydraulic Oil Filter.....	HC-5506	Hydraulic Oil Filter.....	HC-7001	Hydraulic Oil Filter.....	HC-1905
LM732 (HANDLER TELESCOPIC) 2007-UP Hydraulic Oil Filter.....	HC-5506	M459 (HANDLER TELESCOPIC) IVECO Hydraulic Oil Filter.....	HC-5506	T6070 (TRACTORS) 2007-UP Hydraulic Oil Filter.....	HC-5504
LM840 (HANDLER TELESCOPIC) PERKINS PERKINS , 1999 Hydraulic Oil Filter.....	H-51220	Hydraulic Oil Filter.....	HC-7001	Hydraulic Oil Filter.....	HC-1905
LM850 (HANDLER TELESCOPIC) PERKINS PERKINS , 1999 Hydraulic Oil Filter.....	H-51220	(TRACTORS) NEW HOLLAND , 2006-UP Hydraulic Oil Filter.....	HC-45110	T8020 (TRACTORS) 2006-UP Hydraulic Oil Filter.....	HC-5504
LM860 (HANDLER TELESCOPIC) PERKINS PERKINS , 1999 Hydraulic Oil Filter.....	H-51220	(TRACTORS) NEW HOLLAND , 2004-UP Hydraulic Oil Filter.....	HC-45110	TB100 (TRACTORS) NEW HOLLAND , 2003-UP Hydraulic Oil Filter Transmission...	HC-1902
LS120 (SKIDDERS) 2000-UP Hydraulic Oil Filter.....	HC-7925	NH95 (LOADERS) Hydraulic Oil Filter.....	HC-5506	TC18 (TRACTORS) 1998-2003 Hydraulic Oil Filter.....	HC-5816
LV80 (LOADERS) 2002-UP Hydraulic Oil Filter.....	HC-5504	NTT55 (TRACTORS) IVECO Hydraulic Oil Filter.....	HC-45110	TC26DA (TRACTORS) SHIBAURA 1.13L , 2002-UP Hydraulic Oil Filter.....	HC-5816
LW110 (LOADERS) FIAT 8065 Hydraulic Oil Filter.....	HC-76080	SB 33 GRAPE HARVESTER (HARVESTERS) S/N: 90 HP-UP Hydraulic Oil Filter.....	HC-5507	TC27D (TRACTORS) 1998-2003 Hydraulic Oil Filter.....	HC-5816
LW130 (LOADERS) Hydraulic Oil Filter.....	HC-76080	SF550 (SPRAYERS) CUMMINS 6BT5.9 , 1999-UP Hydraulic Oil Filter.....	HC-5504	TC29D (TRACTORS) 1998-2003 Hydraulic Oil Filter.....	HC-5816
LW270 (LOADERS) CHRYSLER M-11 Hydraulic Oil Filter.....	HC-76080	T1520 (TRACTORS) 2007-UP Hydraulic Oil Filter.....	HC-5816	TC21 (TRACTORS) 1998-2003 Hydraulic Oil Filter.....	HC-5816
LW230 (LOADERS) CUMMINS 8.3L Hydraulic Oil Filter.....	HC-76080	T5030 (TRACTORS) IVECO , 2008-UP Hydraulic Oil Filter.....	H-5107	TC30 (TRACTORS) 2001-2003 Hydraulic Oil Filter.....	HC-5816
M-100 (TRACTORS) Hydraulic Oil Filter.....	HC-1905	T5040 (TRACTORS) IVECO , 2008-UP Hydraulic Oil Filter.....	H-5107	TC31DA (TRACTORS) SHIBAURA 1.5L Hydraulic Oil Filter.....	HC-5816
Hydraulic Oil Filter.....	HC-5504	T5050 (TRACTORS) IVECO , 2008-UP Hydraulic Oil Filter.....	H-5107	TC33 (TRACTORS) 1998-2003 Hydraulic Oil Filter.....	HC-5816
M135 (TRACTORS) Hydraulic Oil Filter.....	HC-1905	T5060 (TRACTORS) IVECO , 2008-UP Hydraulic Oil Filter.....	H-5107	TC34DA (TRACTORS) SHIBAURA 1.6L Hydraulic Oil Filter.....	HC-5816
		T-550 (TRENCHERS) WISCONSIN VG-4D Hydraulic Oil Filter Full Flow.....	HC-7901	TC56 (HARVESTERS) Hydraulic Oil Filter.....	HC-5508
		T6020 (TRACTORS) NEW HOLLAND 4.5L TURBO , 2007-UP Hydraulic Oil Filter.....	HC-1905	TD60D (TRACTORS) NEW HOLLAND , 2006-UP	



ENGINE APPLICATION

MODEL/APPLICATION	SAKURA NO	MODEL/APPLICATION	SAKURA NO	MODEL/APPLICATION	SAKURA NO
NEW HOLLAND(CNH)		NEW HOLLAND(CNH)		NEW HOLLAND(CNH)	
TD60D (TRACTORS) NEW HOLLAND , 2006-UP Hydraulic Oil Filter.....	HC-45110	TN55 (TRACTORS) NEW HOLLAND , 1998-2003 Hydraulic Oil Filter.....	H-5107	TN80F (TRACTORS) NEW HOLLAND , 2001-2003 Hydraulic Oil Filter.....	H-5107
TD70D (TRACTORS) NEW HOLLAND , 2006-UP Hydraulic Oil Filter.....	HC-45110	TN60-A (TRACTORS) NEW HOLLAND , 2003-UP Hydraulic Oil Filter.....	H-5107	TN85A (TRACTORS) NEW HOLLAND , 2005-UP Hydraulic Oil Filter.....	H-5107
TD75D (TRACTORS) NEW HOLLAND , 2005-UP Hydraulic Oil Filter.....	HC-45110	TN60VA (TRACTORS) NEW HOLLAND , 2004-UP Hydraulic Oil Filter.....	H-5107	TN85DA (TRACTORS) NEW HOLLAND , 2005-UP Hydraulic Oil Filter.....	H-5107
TD80D PLUS HC (TRACTORS) IVECO (S/N: 4 CYL-UP) , 2008-UP Hydraulic Oil Filter.....	HC-45110	TN65D (TRACTORS) NEW HOLLAND , 1997-2003 Hydraulic Oil Filter.....	H-5107	TN85F-A (TRACTORS) 2004-UP Hydraulic Oil Filter.....	H-5107
TG210 (TRACTORS) 2002-UP Hydraulic Oil Filter.....	HC-5504	TN65V (TRACTORS) NEW HOLLAND , 2000-2003 Hydraulic Oil Filter.....	H-5107	TN85F-A (TRACTORS) NEW HOLLAND , 2003-UP Hydraulic Oil Filter.....	H-5107
TG215A (TRACTORS) 2006-UP Hydraulic Oil Filter.....	HC-5504	TN70 (TRACTORS) NEW HOLLAND , 1999-2003 Hydraulic Oil Filter.....	H-5107	TN90F (TRACTORS) NEW HOLLAND , 1997-2003 Hydraulic Oil Filter.....	H-5107
TG255 (TRACTORS) 2002-UP Hydraulic Oil Filter.....	HC-5504	TN70F (TRACTORS) NEW HOLLAND , 2000-2003 Hydraulic Oil Filter.....	H-5107	TN95A (TRACTORS) NEW HOLLAND , 2005-UP Hydraulic Oil Filter.....	H-5107
TK76 (CRAWLERS) NEW HOLLAND , 1999-UP Hydraulic Oil Filter.....	HC-45110	TN70SA (TRACTORS) NEW HOLLAND , 2003-UP Hydraulic Oil Filter.....	H-5107	TN95DA (TRACTORS) NEW HOLLAND , 2005-UP Hydraulic Oil Filter.....	H-5107
TK90M-A (TRACTORS) NEW HOLLAND , 2004-UP Hydraulic Oil Filter.....	HC-45110	TN70VA (TRACTORS) NEW HOLLAND , 2004-UP Hydraulic Oil Filter.....	H-5107	TN95F (TRACTORS) NEW HOLLAND , 2001-2003 Hydraulic Oil Filter.....	H-5107
TL100 (TRACTORS) NEW HOLLAND , 1998-2003 Hydraulic Oil Filter.....	HC-45110	TN75 (TRACTORS) NEW HOLLAND , 1999-2003 Hydraulic Oil Filter.....	H-5107	TN95F-A (TRACTORS) 2004-UP Hydraulic Oil Filter.....	H-5107
TL100A (TRACTORS) NEW HOLLAND , 2004-UP Hydraulic Oil Filter.....	H-5107	TN75A (TRACTORS) NEW HOLLAND , 2003-UP Hydraulic Oil Filter.....	H-5107	TN95VA (TRACTORS) NEW HOLLAND , 2003-UP Hydraulic Oil Filter.....	H-5107
TL70 (TRACTORS) NEW HOLLAND , 1998-2003 Hydraulic Oil Filter.....	HC-45110	TN75F (TRACTORS) NEW HOLLAND , 1997-2003 Hydraulic Oil Filter.....	H-5107	TR70 (COMBINES) CAT 3208 , 1975-1979 Hydraulic Oil Filter Full Flow.....	HC-7901
TM115 (TRACTORS) NEW HOLLAND , 2000-2002 Hydraulic Oil Filter..... Hydraulic Oil Filter.....	HC-1905 HC-5504	TN75FA (TRACTORS) 2004-UP Hydraulic Oil Filter.....	H-5107	TR70 (COMBINES) FORD 6CYL 2704ET , 1975-1979 Hydraulic Oil Filter..... Hydraulic Oil Filter Full Flow.....	H-51170 HC-7901
TM120 (TRACTORS) NEW HOLLAND , 2002-UP Hydraulic Oil Filter..... Hydraulic Oil Filter.....	HC-1905 HC-5504	TN75FA (TRACTORS) NEW HOLLAND , 2003-UP Hydraulic Oil Filter.....	H-5107	TR70 (COMBINES) FORD 361/V8 , 1975-1979 Hydraulic Oil Filter..... Hydraulic Oil Filter Full Flow.....	H-51170 HC-7901
TM125 (TRACTORS) NEW HOLLAND , 2000-2002 Hydraulic Oil Filter..... Hydraulic Oil Filter.....	HC-5504 HC-1905	TN75SA (TRACTORS) NEW HOLLAND , 2003-UP Hydraulic Oil Filter.....	H-5107	TR75 (COMBINES) CAT 3208 , 1979-1985 Hydraulic Oil Filter..... Hydraulic Oil Filter..... Hydraulic Oil Filter.....	H-51170 HC-5511 HC-7925
TM150 (TRACTORS) NEW HOLLAND 675WV (S/N: 140 HP-UP) Hydraulic Oil Filter..... Hydraulic Oil Filter.....	HC-1905 HC-5504	TN75V (TRACTORS) NEW HOLLAND , 2000-2003 Hydraulic Oil Filter.....	H-5107	TR75 (COMBINES) FORD 6/363 , 1979-1985	
		TN75VA (TRACTORS) NEW HOLLAND , 2004-UP Hydraulic Oil Filter.....	H-5107		



ENGINE APPLICATION

MODEL/APPLICATION	SAKURA NO	MODEL/APPLICATION	SAKURA NO	MODEL/APPLICATION	SAKURA NO
NEW HOLLAND(CNH)		NEW HOLLAND(CNH)		NEW HOLLAND(CNH)	
TR75 (COMBINES) FORD 6/363 , 1979-1985		TS100A (TRACTORS) NEW HOLLAND , 2003-UP		Hydraulic Oil Filter.....	HC-7906
Hydraulic Oil Filter.....	HC-5511	Hydraulic Oil Filter.....	HC-1905	Hydraulic Oil Filter.....	HC-5508
Hydraulic Oil Filter.....	H-51170	Hydraulic Oil Filter.....	HC-5504	TX63RC (HARVESTERS) NEW HOLLAND 675TA	
TR85 (COMBINES) CAT 3208 , 1979-1985		TS110 (TRACTORS) NEW HOLLAND , 1997-2003		Hydraulic Oil Filter.....	HC-5508
Hydraulic Oil Filter.....	H-51170	Hydraulic Oil Filter.....	HC-1905	Hydraulic Oil Filter.....	HC-7906
Hydraulic Oil Filter.....	HC-5511	Hydraulic Oil Filter.....	HC-76080	TX65FS (HARVESTERS) NEW HOLLAND 675TA	
Hydraulic Oil Filter.....	HC-7925	TS110A (TRACTORS) NEW HOLLAND , 2003-2006		Hydraulic Oil Filter.....	HC-5508
TR86 (COMBINES) CAT 3208 , 1984-1994		Hydraulic Oil Filter.....	HC-5504	Hydraulic Oil Filter.....	HC-7906
Hydraulic Oil Filter.....	HC-5511	Hydraulic Oil Filter.....	HC-1905	TX68 (COMBINES) NEW HOLLAND , 1994-UP	
TR86 (EQUIPMENT) FORD 474		TS115 (TRACTORS) NEW HOLLAND , 2001-2003		Hydraulic Oil Filter.....	HC-7906
Hydraulic Oil Filter.....	HC-5511	Hydraulic Oil Filter.....	HC-76080	TX68 (COMBINES) IVECO 8460SRI	
Hydraulic Oil Filter.....	HC-7925	Hydraulic Oil Filter.....	HC-5504	Hydraulic Oil Filter.....	HC-5508
TR89 (COMBINES) NEW HOLLAND , 1999-2002		Hydraulic Oil Filter.....	HC-1905	TX68 PLUS (HARVESTERS) IVECO 8460SRI	
Hydraulic Oil Filter.....	HC-5511	TS115A (TRACTORS) NEW HOLLAND , 2003-UP		Hydraulic Oil Filter.....	HC-7906
Hydraulic Oil Filter.....	HC-7925	Hydraulic Oil Filter.....	HC-1905	Hydraulic Oil Filter.....	HC-5508
TR96 (COMBINES) CAT 3208		TS125A (TRACTORS) NEW HOLLAND , 2003-UP		U80 (LOADERS) NEW HOLLAND 439 , 2006-UP	
Hydraulic Oil Filter.....	HC-7925	Hydraulic Oil Filter.....	HC-1905	Hydraulic Oil Filter.....	HC-5504
Hydraulic Oil Filter.....	HC-5511	TS130A (TRACTORS) NEW HOLLAND 6.7L , 2002-2006		W110 (LOADERS) NEW HOLLAND 4.5L	
TR96 (COMBINES) CAT 636 (S/N: T0-258155)		Hydraulic Oil Filter.....	HC-1905	Hydraulic Oil Filter.....	HC-5506
Hydraulic Oil Filter.....	HC-5511	Hydraulic Oil Filter.....	HC-5504	Hydraulic Oil Filter.....	HC-7001
Hydraulic Oil Filter.....	HC-7925	TS80 (TRACTORS)		W230 (LOADERS) 2005-UP	
TR96 (COMBINES) FORD 678HT (7.8L)		Hydraulic Oil Filter.....	HC-1905	Hydraulic Oil Filter.....	HC-76080
Hydraulic Oil Filter.....	HC-5511	TS90 (TRACTORS) NEW HOLLAND , 1997-2003		NEWIDEA	
Hydraulic Oil Filter.....	HC-7925	Hydraulic Oil Filter.....	HC-1905	707 (COMBINES) PERKINS	
TR96 (EQUIPMENT) FORD		Hydraulic Oil Filter.....	HC-76080	Hydraulic Oil Filter.....	H-51170
Hydraulic Oil Filter.....	HC-5511	Hydraulic Oil Filter.....	HC-5504	802 (COMBINES)	
TR97 (COMBINES) FORD 7.8 L DSL		TS90E (TRACTORS) S/N: 1-1998-UP		Hydraulic Oil Filter.....	H-51170
Hydraulic Oil Filter.....	HC-5511	Hydraulic Oil Filter.....	HC-1905	NISSAN	
Hydraulic Oil Filter.....	HC-7925	Hydraulic Oil Filter.....	HC-5504	A01 (FORKLIFTS)	
TR98 (COMBINES) NEW HOLLAND 7.5L 6CYL		TT55 (TRACTORS) NEW HOLLAND , 2003-UP		Hydraulic Oil Filter.....	HC-1822
Hydraulic Oil Filter.....	HC-7925	Hydraulic Oil Filter.....	HC-45110	AEH02 (FORKLIFTS) NISSAN SD25	
Hydraulic Oil Filter.....	HC-5511	TVT195 (TRACTORS) 2006-UP		Hydraulic Oil Filter.....	HC-1822
TR99 (COMBINES) NEW HOLLAND , 1999-2002		Hydraulic Oil Filter.....	HC-5504	AH01 (FORKLIFTS) NISSAN A15	
Hydraulic Oil Filter.....	HC-7925	TVT-Serie (AGRICULTURE) TVT 145/TVT 190 , 2004		Hydraulic Oil Filter.....	HC-1822
Hydraulic Oil Filter.....	HC-5511	Hydraulic Oil Filter.....	H-45050	APH02 (FORKLIFTS) NISSAN H20	
TS100 (TRACTORS) NEW HOLLAND , 1997-2003		TX62 (HARVESTERS) NEW HOLLAND 675TA (S/N: 206HP-UP)		Hydraulic Oil Filter.....	HC-1822
Hydraulic Oil Filter.....	HC-76080				
Hydraulic Oil Filter.....	HC-1905				
Hydraulic Oil Filter.....	HC-5504				



ENGINE APPLICATION

MODEL/APPLICATION	SAKURA NO	MODEL/APPLICATION	SAKURA NO	MODEL/APPLICATION	SAKURA NO
NISSAN					
B01 (<i>FORKLIFTS</i>)		CHF03 (<i>FORKLIFTS</i>) NISSAN H30		MF05 (<i>FORKLIFTS</i>) NISSAN SD33T , T0-1985	
Hydraulic Oil Filter.....	HC-1822	Hydraulic Oil Filter.....	HC-1822	Hydraulic Oil Filter.....	HC-1822
B02 (<i>FORKLIFTS</i>)		CQF01 (<i>FORKLIFTS</i>) NISSAN SD22 DIESEL		MF05 (<i>FORKLIFTS</i>) NISSAN SD33T , 1985-UP	
Hydraulic Oil Filter.....	HC-1822	Hydraulic Oil Filter.....	HC-1822	Hydraulic Oil Filter.....	HC-1822
BF03 (<i>FORKLIFTS</i>) NISSAN TB42		CQF02 (<i>FORKLIFTS</i>) NISSAN SD22 DIESEL		P5 (<i>FORKLIFTS</i>) NISSAN H20	
Hydraulic Oil Filter.....	HC-1822	Hydraulic Oil Filter.....	HC-1822	Hydraulic Oil Filter.....	HC-1822
BGF03 (<i>FORKLIFTS</i>) NISSAN TB42		CRGH02 (<i>FORKLIFTS</i>) NISSAN Z24		PF01 (<i>FORKLIFTS</i>)	
Hydraulic Oil Filter.....	HC-1822	Hydraulic Oil Filter.....	HC-1822	Hydraulic Oil Filter.....	HC-1822
CD40 (<i>FORKLIFTS</i>)		DF05 (<i>FORKLIFTS</i>) NISSAN FD6		PF01 (<i>FORKLIFTS</i>) NISSAN J15 GAS	
Hydraulic Oil Filter.....	HC-1822	Hydraulic Oil Filter.....	HC-1822	Hydraulic Oil Filter.....	HC-1822
CD40 (<i>FORKLIFTS</i>) NISSAN SD25		EF02 (<i>FORKLIFTS</i>) NISSAN SD25		PF02 (<i>FORKLIFTS</i>) NISSAN H20	
Hydraulic Oil Filter.....	HC-1822	Hydraulic Oil Filter.....	HC-1822	Hydraulic Oil Filter.....	HC-1822
CD4000 (<i>FORKLIFTS</i>)		EH01 (<i>FORKLIFTS</i>) NISSAN SD25		PF02 (<i>FORKLIFTS</i>) NISSAN SD22	
Hydraulic Oil Filter.....	HC-1822	Hydraulic Oil Filter.....	HC-1822	Hydraulic Oil Filter.....	HC-1822
CEF02 (<i>FORKLIFTS</i>) NISSAN SD25 DIESEL		EH02 (<i>FORKLIFTS</i>) NISSAN SD25		PH01 (<i>FORKLIFTS</i>) NISSAN H20	
Hydraulic Oil Filter.....	HC-1822	Hydraulic Oil Filter.....	HC-1822	Hydraulic Oil Filter.....	HC-1822
CEH01 (<i>FORKLIFTS</i>) NISSAN SD25 DIESEL		F01 (<i>FORKLIFTS</i>) NISSAN J15 , 1977-UP		QF01 (<i>FORKLIFTS</i>) NISSAN SD22 DIESEL	
Hydraulic Oil Filter.....	HC-1822	Hydraulic Oil Filter.....	HC-1822	Hydraulic Oil Filter.....	HC-1822
CEH02 (<i>FORKLIFTS</i>) NISSAN SD25 DIESEL		F01 (<i>FORKLIFTS</i>) NISSAN H20		QF02 (<i>FORKLIFTS</i>)	
Hydraulic Oil Filter.....	HC-1822	Hydraulic Oil Filter.....	HC-1822	Hydraulic Oil Filter.....	HC-1822
CF01 (<i>FORKLIFTS</i>) NISSAN J15 GAS		F01 (<i>FORKLIFTS</i>) NISSAN J15		QF-03 (<i>FORKLIFTS</i>)	
Hydraulic Oil Filter.....	HC-1822	Hydraulic Oil Filter.....	HC-1822	Hydraulic Oil Filter.....	HC-1822
CF02 (<i>FORKLIFTS</i>) NISSAN H20		F02 (<i>FORKLIFTS</i>) NISSAN J15		SD25 (<i>FORKLIFTS</i>)	
Hydraulic Oil Filter.....	HC-1822	Hydraulic Oil Filter.....	HC-1822	Hydraulic Oil Filter.....	HC-1822
CFG003 (<i>FORKLIFTS</i>) NISSAN D11		F302 (<i>FORKLIFTS</i>)		UF03 (<i>FORKLIFTS</i>) NISSAN P40	
Hydraulic Oil Filter.....	HC-1822	Hydraulic Oil Filter.....	HC-1822	Hydraulic Oil Filter.....	HC-1822
CFG005 (<i>FORKLIFTS</i>) NISSAN H20		FG003 (<i>FORKLIFTS</i>) NISSAN D11		UF05 (<i>FORKLIFTS</i>) NISSAN P40	
Hydraulic Oil Filter.....	HC-1822	Hydraulic Oil Filter.....	HC-1822	Hydraulic Oil Filter.....	HC-1822
CFG105 (<i>FORKLIFTS</i>) NISSAN H20		FG005 (<i>FORKLIFTS</i>) NISSAN H20		WF03 (<i>FORKLIFTS</i>) NISSAN TD42	
Hydraulic Oil Filter.....	HC-1822	Hydraulic Oil Filter.....	HC-1822	Hydraulic Oil Filter.....	HC-1822
CH01 (<i>FORKLIFTS</i>) NISSAN H20		M01 (<i>FORKLIFTS</i>)		WGF03 (<i>FORKLIFTS</i>) NISSAN TD42	
Hydraulic Oil Filter.....	HC-1822	Hydraulic Oil Filter.....	HC-1822	Hydraulic Oil Filter.....	HC-1822
CH02 (<i>FORKLIFTS</i>) NISSAN H20		M02 (<i>FORKLIFTS</i>)		YF03 (<i>FORKLIFTS</i>) NISSAN SD33T , T0-1985	
Hydraulic Oil Filter.....	HC-1822	Hydraulic Oil Filter.....	HC-1822	Hydraulic Oil Filter.....	HC-1822



ENGINE APPLICATION

MODEL/APPLICATION	SAKURA NO	MODEL/APPLICATION	SAKURA NO	MODEL/APPLICATION	SAKURA NO
NISSAN		OWATONNA		PAYHAULER	
YF03 (<i>FORKLIFTS</i>) NISSAN SD33T , 1985-UP Hydraulic Oil Filter.....	HC-1822	Hydraulic Oil Filter.....	HC-7932	PH-95 (<i>HAULERS</i>) IHC DT817 Hydraulic Oil Filter Transmission...	H-65030
OLIVER		330 MUSTANG (<i>CONSTRUCTION & MINING</i>) ONAN NH-MS Hydraulic Oil Filter.....	HC-5511	PH-95 (<i>HAULERS</i>) PAYHAULE NRT0-6 Hydraulic Oil Filter Transmission...	H-65030
1755 (<i>TRACTORS</i>) Hydraulic Oil Filter.....	H-51170	Hydraulic Oil Filter.....	H-79411	PEL - JOB	
1855 (<i>TRACTORS</i>) Hydraulic Oil Filter.....	H-51170	Hydraulic Oil Filter.....	HC-5511	EB25.4 (<i>SHOVELS</i>) S/N: 21359-UP , 1994-UP Hydraulic Oil Filter.....	HC-55190
1900 (<i>TRACTORS</i>) Hydraulic Oil Filter Transmission...	H-65030	345 (<i>CONSTRUCTION & MINING</i>) Hydraulic Oil Filter.....	HC-5511	EB68 (<i>SHOVELS</i>) Hydraulic Oil Filter.....	H-85560
1955 (<i>TRACTORS</i>) Hydraulic Oil Filter.....	H-51170	770 MUSTANG (<i>LOADERS</i>) FORD 172 DIESEL Hydraulic Oil Filter.....	H-79411	PERLINI	
2255 (<i>TRACTORS</i>) Hydraulic Oil Filter.....	H-51170	880 ARTICULATED MUSTANG (<i>LOADERS</i>) FORD 256 DIESEL Hydraulic Oil Filter.....	H-79411	T40 (<i>DUMP TRUCKS</i>) DETROIT DIESEL Hydraulic Oil Filter Transmission...	H-65030
ORENSTEIN & KOPPEL		880 ARTICULATED MUSTANG (<i>LOADERS</i>) PERKINS 4.248 DIESEL Hydraulic Oil Filter.....	H-79411	PETERBILT	
40.5 (<i>DUMP TRUCKS</i>) Hydraulic Oil Filter.....	H-76050	PALFINGER		210 (<i>TRUCKS</i>) PX6 Hydraulic Oil Filter Transmission....	H-8538
F206 (<i>LOADERS</i>) DEUTZ BF6L913 , 2001-UP Hydraulic Oil Filter.....	HC-6802	PK 17000 (<i>CRANES</i>) Hydraulic Oil Filter.....	H-85920	Hydraulic Oil Filter Transmission...	H-8537-S
L35.5 (<i>LOADERS</i>) DEUTZ BF6M1013EC Hydraulic Oil Filter.....	HC-6802	PAYHAULER		220 (<i>LIGHT COMMERCIALS</i>) PX6 Hydraulic Oil Filter Transmission...	H-8537-S
L45 (<i>LOADERS</i>) CUMMINS LT10 , 1993 Hydraulic Oil Filter.....	HC-5503	PH-100B (<i>HAULERS</i>) IHC DT817B Hydraulic Oil Filter Transmission...	H-65030	Hydraulic Oil Filter Transmission....	H-8538
MH4 (<i>EXCAVATORS</i>) DEUTZ F4L912 Hydraulic Oil Filter.....	H-85110	PH-140 (<i>HAULERS</i>) IHC DT817 Hydraulic Oil Filter.....	H-5406	282 (<i>TRUCKS</i>) 1693 SERIES Hydraulic Oil Filter.....	HC-5502
OWATONNA		PH-330 (<i>HAULERS</i>) IHC DT817B Hydraulic Oil Filter.....	H-5406	282 (<i>TRUCKS</i>) 3406 Hydraulic Oil Filter.....	HC-5502
1000 MUSTANG (<i>LOADERS</i>) WISCONSIN VH4D Hydraulic Oil Filter.....	H-79411	PH-330 (<i>HAULERS</i>) IHC DT817C Hydraulic Oil Filter.....	H-5406	289 (<i>TRUCKS</i>) 12V-71 Hydraulic Oil Filter Transmission...	H-65030
1200 MUSTANG (<i>LOADERS</i>) WISCONSIN VH4D Hydraulic Oil Filter.....	H-79411	PH-350 (<i>HAULERS</i>) Hydraulic Oil Filter.....	H-5406	289 (<i>TRUCKS</i>) 1693 SERIES Hydraulic Oil Filter.....	HC-5502
1700 MUSTANG (<i>LOADERS</i>) FORD V4-104 Hydraulic Oil Filter.....	H-79411	PH-65 (<i>HAULERS</i>) CUMMINS NT-6 Hydraulic Oil Filter Transmission...	H-65030	310 (<i>TRUCKS</i>) 6V-92T Hydraulic Oil Filter Transmission...	H-65030
1700 MUSTANG (<i>LOADERS</i>) WISCONSIN VG-4D Hydraulic Oil Filter.....	H-79411	PH-65 (<i>HAULERS</i>) PAYHAULE D-817 Hydraulic Oil Filter Transmission...	H-65030	310 (<i>TRUCKS</i>) 6V-92TT Hydraulic Oil Filter Transmission...	H-65030
312 (<i>CONSTRUCTION & MINING</i>)		PH-65 SERIES B (<i>HAULERS</i>) PAYHAULE DVT-573 Hydraulic Oil Filter Transmission...	H-65030	320 (<i>TRUCKS</i>) 3126B Hydraulic Oil Filter Transmission...	H-8537-S
		PH-95 (<i>HAULERS</i>) CUMMINS NT-335 Hydraulic Oil Filter Transmission...	H-65030	Hydraulic Oil Filter Transmission....	H-8538



ENGINE APPLICATION

MODEL/APPLICATION	SAKURA NO	MODEL/APPLICATION	SAKURA NO	MODEL/APPLICATION	SAKURA NO
PETERBILT					
320 (TRUCKS) L10 Hydraulic Oil Filter Transmission..	H-8537-S	352H (TRUCKS) 12V-71 Hydraulic Oil Filter Transmission...	H-65030	365 (TRUCKS) ISM Hydraulic Oil Filter Transmission....	H-8538
320 HE / HYBRID (TRUCKS) ISM Hydraulic Oil Filter Transmission..	H-8537-S	352H (TRUCKS) 1693 SERIES Hydraulic Oil Filter.....	HC-5502	365 (TRUCKS) ISX Hydraulic Oil Filter Transmission....	H-8538
Hydraulic Oil Filter Transmission....	H-8538	352H (TRUCKS) 3406 Hydraulic Oil Filter.....	HC-5502	Hydraulic Oil Filter Transmission..	H-8537-S
330 HE / HYBRID (TRUCKS) PX6 Hydraulic Oil Filter Transmission..	H-8537-S	357 (TRUCKS) C15 Hydraulic Oil Filter.....	HC-5502	365 (TRUCKS) PX9 Hydraulic Oil Filter Transmission....	H-8538
Hydraulic Oil Filter Transmission....	H-8538	357 (TRUCKS) C16 Hydraulic Oil Filter.....	HC-5502	Hydraulic Oil Filter Transmission..	H-8537-S
335 (TRUCKS) ISB Hydraulic Oil Filter Transmission..	H-8537-S	357 (TRUCKS) C16 Hydraulic Oil Filter.....	HC-5502	367 (TRUCKS) C13 Hydraulic Oil Filter Transmission....	H-8538
Hydraulic Oil Filter Transmission....	H-8538	357 (TRUCKS) CUMMINS 6C8.3 Hydraulic Oil Filter.....	HC-62010	Hydraulic Oil Filter Transmission..	H-8537-S
335 HE / HYBRID (TRUCKS) PX6 Hydraulic Oil Filter Transmission..	H-8537-S	357 (TRUCKS) CUMMINS L10 Hydraulic Oil Filter.....	HC-5511	367 (TRUCKS) C15 Hydraulic Oil Filter Transmission..	H-8537-S
Hydraulic Oil Filter Transmission....	H-8538	357 (TRUCKS) CUMMINS M11 Hydraulic Oil Filter.....	HC-5511	Hydraulic Oil Filter.....	HC-5502
337 (TRUCKS) PX6 Hydraulic Oil Filter Transmission..	H-8537-S	359 (TRUCKS) 12V-71 Hydraulic Oil Filter Transmission...	H-65030	Hydraulic Oil Filter Transmission....	H-8538
Hydraulic Oil Filter Transmission....	H-8538	359 (TRUCKS) 1693 SERIES Hydraulic Oil Filter.....	HC-5502	367 (TRUCKS) HD GX 15.0L Hydraulic Oil Filter Transmission....	H-8538
337 (TRUCKS) PX7 Hydraulic Oil Filter Transmission..	H-8537-S	365 (TRUCKS) C13 Hydraulic Oil Filter Transmission....	H-8538	Hydraulic Oil Filter Transmission..	H-8537-S
Hydraulic Oil Filter Transmission....	H-8538	365 (TRUCKS) C15 Hydraulic Oil Filter Transmission..	H-8537-S	372 (TRUCKS) C15 Hydraulic Oil Filter.....	HC-5502
337 (TRUCKS) PX9 Hydraulic Oil Filter Transmission..	H-8537-S	365 (TRUCKS) C15 Hydraulic Oil Filter Transmission....	H-8538	Hydraulic Oil Filter.....	HC-5502
Hydraulic Oil Filter Transmission....	H-8538	365 (TRUCKS) C9 Hydraulic Oil Filter Transmission....	H-8538	375 (TRUCKS) SERIES 60 Hydraulic Oil Filter Power steering..	H-71160
348 (TRUCKS) 1693 SERIES Hydraulic Oil Filter.....	HC-5502	365 (TRUCKS) C15 Hydraulic Oil Filter Transmission..	H-8537-S	378 (TRUCKS) C15 Hydraulic Oil Filter.....	HC-5502
348 (TRUCKS) PX9 Hydraulic Oil Filter Transmission....	H-8538	Hydraulic Oil Filter.....	HC-5502	Hydraulic Oil Filter Transmission..	H-8537-S
Hydraulic Oil Filter Transmission..	H-8537-S	365 (TRUCKS) C15 Hydraulic Oil Filter Transmission....	H-8538	379 (TRUCKS) 3406E Hydraulic Oil Filter.....	HC-5502
349 (TRUCKS) CUMMINS L10 Hydraulic Oil Filter.....	HC-62010	365 (TRUCKS) C15 Hydraulic Oil Filter Transmission..	H-8537-S	Hydraulic Oil Filter.....	HC-5502
349 (TRUCKS) CUMMINS NTC-230 Hydraulic Oil Filter.....	HC-62010	Hydraulic Oil Filter.....	HC-5502	379 (TRUCKS) C10 Hydraulic Oil Filter.....	HC-5502
352 (TRUCKS) 1693 SERIES Hydraulic Oil Filter.....	HC-5502	365 (TRUCKS) ISL Hydraulic Oil Filter Transmission....	H-8538	Hydraulic Oil Filter.....	HC-5502
352 (TRUCKS) 3406 Hydraulic Oil Filter.....	HC-5502	Hydraulic Oil Filter Transmission..	H-8537-S	379 (TRUCKS) C12 Hydraulic Oil Filter.....	HC-5502
		365 (TRUCKS) ISL G Hydraulic Oil Filter Transmission....	H-8538	Hydraulic Oil Filter.....	HC-5502
		Hydraulic Oil Filter Transmission..	H-8537-S	379 (TRUCKS) C13 Hydraulic Oil Filter.....	HC-5502



ENGINE APPLICATION

MODEL/APPLICATION	SAKURA NO	MODEL/APPLICATION	SAKURA NO	MODEL/APPLICATION	SAKURA NO
PETERBILT		PETERBILT		POCLAIN	
379 (TRUCKS) C16		Hydraulic Oil Filter Transmission....	H-8538	125P (EXCAVATORS)	
Hydraulic Oil Filter.....	HC-5502	385 (TRUCKS) ISL		Hydraulic Oil Filter.....	H-85110
379X (TRUCKS) C10		Hydraulic Oil Filter Transmission..	H-8537-S	170 (EXCAVATORS) DEUTZ (S/N: SERIES B-UP)	
Hydraulic Oil Filter.....	HC-5502	Hydraulic Oil Filter Transmission....	H-8538	Hydraulic Oil Filter.....	H-85110
379X (TRUCKS) C11		385 (TRUCKS) ISM		170CK (EXCAVATORS) DEUTZ B6L513R	
Hydraulic Oil Filter.....	HC-5502	Hydraulic Oil Filter Transmission..	H-8537-S	Hydraulic Oil Filter.....	H-85110
379X (TRUCKS) C12		Hydraulic Oil Filter Transmission....	H-8538	Hydraulic Oil Filter.....	H-71140
Hydraulic Oil Filter.....	HC-5502	385 (TRUCKS) ISX		220 (EXCAVATORS) DEUTZ F10L413	
379X (TRUCKS) C13		Hydraulic Oil Filter Transmission....	H-8538	Hydraulic Oil Filter.....	H-71140
Hydraulic Oil Filter.....	HC-5502	Hydraulic Oil Filter Transmission..	H-8537-S	220CL (EXCAVATORS) DEUTZ	
382 (TRUCKS) ISL9 , 2010		386 (TRUCKS) C15		Hydraulic Oil Filter.....	H-71140
Hydraulic Oil Filter Transmission..	H-8537-S	Hydraulic Oil Filter.....	HC-5502	300CK (EXCAVATORS) DEUTZ F12L413	
Hydraulic Oil Filter Transmission....	H-8538	387 (TRUCKS) 3406E		Hydraulic Oil Filter.....	H-85110
383 (TRUCKS) 12V-71		Hydraulic Oil Filter.....	HC-5502	350 (EXCAVATORS) DEUTZ (S/N: SERIES B-UP)	
Hydraulic Oil Filter Transmission...	H-65030	388 (TRUCKS) C15		Hydraulic Oil Filter.....	H-85110
384 (TRUCKS) ISL		Hydraulic Oil Filter.....	HC-5502	400 (EXCAVATORS) DEUTZ BF12L413	
Hydraulic Oil Filter Transmission..	H-8537-S	389 (TRUCKS) C15		Hydraulic Oil Filter.....	H-85110
Hydraulic Oil Filter Transmission....	H-8538	Hydraulic Oil Filter.....	HC-5502	70 (EXCAVATORS) DEUTZ (S/N: SERIES B-UP)	
384 (TRUCKS) ISL G		389 (TRUCKS) C16		Hydraulic Oil Filter.....	H-71140
Hydraulic Oil Filter Transmission..	H-8537-S	Hydraulic Oil Filter.....	HC-5502	75CL (EXCAVATORS) DEUTZ F5L912	
Hydraulic Oil Filter Transmission....	H-8538	567 (TRUCKS) PX9		Hydraulic Oil Filter.....	H-71140
385 (TRUCKS) 3176B		Hydraulic Oil Filter Transmission..	H-8537-S	Hydraulic Oil Filter.....	H-85110
Hydraulic Oil Filter.....	HC-5502	Hydraulic Oil Filter Transmission....	H-8538	75CL (EXCAVATORS) DEUTZ F6L912	
385 (TRUCKS) C10		P & H CO.		Hydraulic Oil Filter.....	H-85110
Hydraulic Oil Filter.....	HC-5502	100 CRANE (CRANES) IHC DT817		Hydraulic Oil Filter.....	H-71140
385 (TRUCKS) C11		Hydraulic Oil Filter Transmission....	H-65030	75CK (EXCAVATORS) DEUTZ F5L912	
Hydraulic Oil Filter Transmission....	H-8538	POCLAIN		Hydraulic Oil Filter.....	H-85110
Hydraulic Oil Filter.....	HC-5502	115 (EXCAVATORS)		85 (EXCAVATORS) DEUTZ (S/N: SERIES B-UP)	
Hydraulic Oil Filter Transmission..	H-8537-S	Hydraulic Oil Filter.....	H-76050	Hydraulic Oil Filter.....	H-71140
385 (TRUCKS) C12		115CL (EXCAVATORS) DEUTZ BF6L913		988P2AL (EXCAVATORS) CASE 6T590	
Hydraulic Oil Filter.....	HC-5502	Hydraulic Oil Filter.....	H-85110	Hydraulic Oil Filter.....	HC-5506
385 (TRUCKS) C13		Hydraulic Oil Filter.....	H-71140	FC30 (EXCAVATORS) DEUTZ F3L912	
Hydraulic Oil Filter Transmission....	H-8538	1188 (EXCAVATORS) CASE 6T590		Hydraulic Oil Filter.....	HC-1822
Hydraulic Oil Filter Transmission..	H-8537-S	Hydraulic Oil Filter.....	HC-5506	GC120 (EXCAVATORS) DEUTZ F6L514	
Hydraulic Oil Filter.....	HC-5502	125 (EXCAVATORS) DEUTZ (S/N: SERIES B-UP)		Hydraulic Oil Filter.....	H-85110
385 (TRUCKS) C15		Hydraulic Oil Filter.....	H-71140		
Hydraulic Oil Filter.....	HC-5502	Hydraulic Oil Filter.....	H-76050		



ENGINE APPLICATION

MODEL/APPLICATION	SAKURA NO	MODEL/APPLICATION	SAKURA NO	MODEL/APPLICATION	SAKURA NO
POCLAIN		PPM		RAYGO	
R-200 (EXCAVATORS)		Hydraulic Oil Filter Transmission... HC-2701		RASCAL 400A (CONSTRUCTION EQUIPMENTS) DETROITD A3-53	
Hydraulic Oil Filter..... H-85110		PUTZMEISTER		Hydraulic Oil Filter..... H-51170	
Hydraulic Oil Filter..... H-71140		P117 BHM (AIR COMPRESSORS)		RASCAL 410A (CONSTRUCTION EQUIPMENTS) DETROITD 3-53	
S150 (EXCAVATORS) DEUTZ F5/6L912		Hydraulic Oil Filter..... HC-6217		Hydraulic Oil Filter..... H-51170	
Hydraulic Oil Filter..... H-71140		SP11 DMB (AIR COMPRESSORS)		RASCAL 420C (CONSTRUCTION EQUIPMENTS) DETROITD 4-53	
S150 (EXCAVATORS) DEUTZ F6L812		Hydraulic Oil Filter..... HC-6217		Hydraulic Oil Filter..... H-51170	
Hydraulic Oil Filter..... H-71140		QUINCY		RASCAL 500A (CONSTRUCTION EQUIPMENTS) DETROITD 4-53	
S150 (EXCAVATORS) POCLAIN BF6L913		Q5235 (AIR COMPRESSORS)		Hydraulic Oil Filter..... H-51170	
Hydraulic Oil Filter..... H-85110		Hydraulic Oil Filter..... HC-6901		RASCAL 600A (CONSTRUCTION EQUIPMENTS) DETROITD 4-53	
Hydraulic Oil Filter..... H-71140		RAYGO		Hydraulic Oil Filter..... H-51170	
tC (EXCAVATORS) DEUTZ F4L812D		GATOR 8 16 (CONSTRUCTION EQUIPMENTS) DETROITD 8V-71		Hydraulic Oil Filter..... H-51170	
Hydraulic Oil Filter..... H-85110		Hydraulic Oil Filter..... H-51170		ROOMPER 2 36 (CONSTRUCTION EQUIPMENTS) DEUTZ F2L411D	
TC45A (EXCAVATORS) POCLAIN AGROM 4R316		GIANT EARTH LEVELER (CONSTRUCTION EQUIPMENTS) DETROITD 8V-71N DIESEL		Hydraulic Oil Filter..... H-51170	
Hydraulic Oil Filter..... H-62040		Hydraulic Oil Filter..... H-51170		RUMBER SF-54A (CONSTRUCTION EQUIPMENTS) HATZ 28HP DIESEL	
PPM		RAM 30 (CONSTRUCTION EQUIPMENTS) CUMMINS V-504		Hydraulic Oil Filter..... H-51170	
290ATT (CRANES)		Hydraulic Oil Filter..... H-51170		RUMBER SF-54A (CONSTRUCTION EQUIPMENTS)	
Hydraulic Oil Filter..... HC-5506		RAM 45 (CONSTRUCTION EQUIPMENTS) DETROITD 6V-71		Hydraulic Oil Filter..... H-51170	
380ATT (CONSTRUCTION & MINING) KHD BF6L513R		Hydraulic Oil Filter Transmission... H-65030		RUMBER SF-54A (CONSTRUCTION EQUIPMENTS) WISCONSIN 30 HP	
Hydraulic Oil Filter Transmission... HC-2701		Hydraulic Oil Filter..... H-51170		Hydraulic Oil Filter..... H-51170	
Hydraulic Oil Filter Transmission... HC-2701		RAM 65 (CONSTRUCTION EQUIPMENTS) DETROITD 8V-71N		RUSTLER 304A (CONSTRUCTION EQUIPMENTS) JDEERE 4219	
Hydraulic Oil Filter..... H-76050		Hydraulic Oil Filter..... H-51170		Hydraulic Oil Filter..... H-51170	
390ATT (CONSTRUCTION & MINING) MERCEDES OM366LA		RAM-PAK 30 (CONSTRUCTION EQUIPMENTS) CUMMINS V-504		Hydraulic Oil Filter..... H-51170	
Hydraulic Oil Filter Transmission... HC-2701		Hydraulic Oil Filter..... H-51170		RUSTLER 404B (CONSTRUCTION EQUIPMENTS) DETROITD 3-53	
Hydraulic Oil Filter Transmission... HC-2701		RAM-PAK 45 (CONSTRUCTION EQUIPMENTS) DETROITD 6V-71N		Hydraulic Oil Filter..... H-51170	
Hydraulic Oil Filter..... HC-5506		Hydraulic Oil Filter..... H-51170		REED	
40 GMI (CRANES) S/N: VHX17071-UP		RAM-PAK 65 (CONSTRUCTION EQUIPMENTS) DETROITD 8V-71N		SK40 (DRILLING) CAT 3406	
Hydraulic Oil Filter..... H-76040		Hydraulic Oil Filter..... H-51170		Hydraulic Oil Filter..... H-5517	
540 (CONSTRUCTION & MINING) 540		RANGER 2 66 (CONSTRUCTION EQUIPMENTS) DETROITD 4-53		Hydraulic Oil Filter..... HC-5511	
Hydraulic Oil Filter..... H-7961		Hydraulic Oil Filter..... H-51170		RENAULT TRUCKS(RVI)	
540 (CONSTRUCTION & MINING)		RANGER 2 84 (CONSTRUCTION EQUIPMENTS) DETROITD 6V-53		MAGNUM AE 440 DXI (TRUCKS) RENAULTT DXI 12 , 2005-UP	
Hydraulic Oil Filter..... H-7961		Hydraulic Oil Filter..... H-51170		Hydraulic Oil Filter Transmission.... H-7102	
A600 (CRANES) CUMMINS 6CT8.3		RASCAL 300A (CONSTRUCTION EQUIPMENTS) JDEERE 4219		MAGNUM AE 460 DXI (TRUCKS) RENAULTT DXI 13 (S/N: EURO 4/5-UP) , 2006-UP	
Hydraulic Oil Filter..... H-7961		Hydraulic Oil Filter..... H-51170		Hydraulic Oil Filter Transmission.... H-7102	
A600L (CRANES) S/N: 505262-UP		RENAULT V.I		AGORA (BUSES) RENAULTV MIDS 06.20.45 RS	
Hydraulic Oil Filter..... H-7961		RASCAL 320A (CONSTRUCTION EQUIPMENTS) JDEERE 4276D		Hydraulic Oil Filter Transmission.... H-7102	
C580 (CRANES)		Hydraulic Oil Filter..... H-51170			



ENGINE APPLICATION

MODEL/APPLICATION	SAKURA NO	MODEL/APPLICATION	SAKURA NO	MODEL/APPLICATION	SAKURA NO
RENAULT V. I		ROSSI		SAMBRON	
MAGNUM AE 400 E-TECH (TRUCKS) RENAULTV MIDR 06.24.65 , 2000-2005	H-7102	1004 (SHOVELS) PERKINS 4.236	H-65030	2504T (FORKLIFTS) PERKINS 4.236	HC-7906
MAGNUM AE 440 E-TECH (TRUCKS) RENAULTV MIDR 06.24.65 , 2000-2005	H-7102	1006 (SHOVELS) PERKINS 6.354	H-65030	SAME, HURLIMANN, LAMBORGHINI	
MAGNUM AE 480 E-TECH (TRUCKS) RENAULTV MIDR 06.24.65 , 2000-2005	H-7102	SAKAI		ANTARES 100 (TRACTORS) SAME 1000.4 ATI (S/N: 2163-UP)	HC-45110
MIDLUM 220.08 DCI (TRUCKS) RENAULTV DCI6-220 , 2001-2006	H-7102	SV201D (COMPACTORS)	HC-55240	Hydraulic Oil Filter.....	HC-51040
PR100 (BUSES) RENAULTV MIDS/MIP 06.20.30	H-7102	SV201T (COMPACTORS)	HC-55240	ANTARES 100 (TRACTORS) SAME 1000.4 ATI (S/N: TO-2162)	HC-45110
PR112 (BUSES) RENAULTV MIDS 06.20.45 RS	H-7102	SV201TB (COMPACTORS)	HC-55240	Hydraulic Oil Filter.....	HC-51040
PR180 (BUSES) RENAULTV MIDS/MIP 06.20.30	H-7102	SV201TF (COMPACTORS)	HC-55240	ANTARES 110 (TRACTORS) SAME 1000.6A (S/N: 1555-UP)	HC-45110
R312 (BUSES) RENAULTV MIDR 06.20.45	H-7102	SV400D (COMPACTORS)	HC-55240	Hydraulic Oil Filter.....	HC-51040
R312 (BUSES) RENAULTV MIDS 06.20.45	H-7102	SV400T (COMPACTORS)	HC-55240	ANTARES 110 (TRACTORS) SAME 1000.6A (S/N: TO-1554)	HC-51040
RECREO (BUSES) RENAULTV MIHR 06.20.45 , 1996-UP	H-7102	SV400TB (COMPACTORS)	HC-55240	Hydraulic Oil Filter.....	HC-51040
Tracer (BUSES) RENAULTV MIDR 06.20.45 , 1993	H-7102	SV400TF (COMPACTORS)	HC-55240	ANTARES 130 (TRACTORS) SAME 1000.6 AT (S/N: 1524-UP)	HC-51040
TRM9000 (BUSES) MAN D0836HM8U	H-7102	SV510 (COMPACTORS)	HC-55240	Hydraulic Oil Filter.....	HC-45110
REX		SW650 (COMPACTORS)	HC-55240	ANTARES 130 (TRACTORS) S/N: TO-4000	HC-51040
590 (MIXERS)	HC-79331	SW800 (COMPACTORS) DEUTZ BF4M2012C	HC-55240	ANTARES II 110 (TRACTORS) PERKINS 1000.6 A (S/N: 4001-UP)	HC-51040
RICKEL MFG. CO.		SW850 (COMPACTORS) DEUTZ BF4M2012C	HC-55240	ANTARES II 130 (TRACTORS) PERKINS 1000.6 AT (S/N: 4001-UP)	HC-51040
BIG A 2500 (TRACTORS) CUMMINS V-504	H-51170	SW900 (COMPACTORS) ISUZU 6BG1T	HC-55240	ARGON 50 (TRACTORS) PERKINS 1000.3 , 1993-UP	HC-51040
RIMPULL		SAMBRON		ARGON 60 (TRACTORS) PERKINS 1000.3 A , 1993-UP	HC-51040
RD65 (HAULERS) CUMMINS KTA-1150	H-65030	2504 (FORKLIFTS) PERKINS 4.236	HC-7906	ARGON 70 (TRACTORS) PERKINS 1000.3 AT (S/N: TO-2857) , 1993-UP	HC-51040
ROSSI					



ENGINE APPLICATION

MODEL/APPLICATION	SAKURA NO	MODEL/APPLICATION	SAKURA NO	MODEL/APPLICATION	SAKURA NO
SAME, HURLIMANN, LAMBORGHINI					
ARGON 70 (TRACTORS) S/N: 2858-UP		EXPLORER 70 SP (TRACTORS) S/N: 15500-UP , 1986-UP		EXPLORER 90 SP (TRACTORS) S/N: T0-2499	
Hydraulic Oil Filter.....	HC-51040	Hydraulic Oil Filter.....	HC-51040	Hydraulic Oil Filter.....	HC-45110
ASTER 60 (TRACTORS)		EXPLORER 70 SP II (TRACTORS) PERKINS 1000.4 , 1986-UP		Hydraulic Oil Filter.....	HC-51040
Hydraulic Oil Filter.....	HC-51040	Hydraulic Oil Filter.....	HC-51040	EXPLORER 90 SP LP (TRACTORS)	
ASTER 70 (TRACTORS)		EXPLORER 80 II (TRACTORS) PERKINS 1000 SERIES		Hydraulic Oil Filter.....	HC-51040
Hydraulic Oil Filter.....	HC-51040	Hydraulic Oil Filter.....	HC-51040	EXPLORER 90 T II (TRACTORS)	
CENTAURO 70 EXPORT (TRACTORS) 1982-UP		Hydraulic Oil Filter.....	HC-45110	Hydraulic Oil Filter.....	HC-45110
Hydraulic Oil Filter.....	HC-51040	EXPLORER 80 SP (TRACTORS) S/N: 12955-UP , 1986-UP		FRUTTETO 60 (HARVESTERS) S/N: T0-1906	
CENTAURO 70 SPECIAL (TRACTORS) 1982-UP		Hydraulic Oil Filter.....	HC-51040	Hydraulic Oil Filter.....	HC-51040
Hydraulic Oil Filter.....	HC-51040	Hydraulic Oil Filter.....	HC-45110	FRUTTETO 60 II (TRACTORS) S/N: 1907-UP	
CENTURION 75 EXPORT (TRACTORS) S/N: 5001-UP , 1981-UP		EXPLORER 80 SP (TRACTORS) S/N: 15500-UP , 1986-UP		Hydraulic Oil Filter.....	HC-51040
Hydraulic Oil Filter.....	HC-51040	Hydraulic Oil Filter.....	HC-51040	FRUTTETO 75 (HARVESTERS)	
CENTURION 75 SP. (TRACTORS) 1981-UP		Hydraulic Oil Filter.....	HC-45110	Hydraulic Oil Filter.....	HC-51040
Hydraulic Oil Filter.....	HC-51040	EXPLORER 80 SP (TRACTORS) S/N: T0-12954 , 1986-UP		FRUTTETO 75 II (TRACTORS) S/N: 2230-UP	
DIAMOND 230 (TRACTORS) KHD BF6M1013FC , 1999-UP		Hydraulic Oil Filter.....	HC-51040	Hydraulic Oil Filter.....	HC-51040
Hydraulic Oil Filter.....	HC-5504	Hydraulic Oil Filter.....	HC-45110	FRUTTETO 75 II (TRACTORS) S/N: T0-2229	
DORADO 60 (TRACTORS)		EXPLORER 80 SP (TRACTORS) S/N: T0-15499 , 1986-UP		Hydraulic Oil Filter.....	HC-51040
Hydraulic Oil Filter.....	HC-51040	Hydraulic Oil Filter.....	HC-51040	FRUTTETO 85 II (TRACTORS) S/N: 1204-UP	
DORADO 65 (TRACTORS) PERKINS 1000.3 AT		Hydraulic Oil Filter.....	HC-45110	Hydraulic Oil Filter.....	HC-51040
Hydraulic Oil Filter.....	HC-51040	EXPLORER 80 SP II (TRACTORS) 1986-UP		FRUTTETO 85 II (TRACTORS) S/N: T0-1203	
DORADO 70 (TRACTORS)		Hydraulic Oil Filter.....	HC-51040	Hydraulic Oil Filter.....	HC-51040
Hydraulic Oil Filter.....	HC-51040	EXPLORER 80 SP LP (TRACTORS) 1986-UP		FRUTTETO II 60 (TRACTORS) PERKINS 1000.3 A (S/N: T0-1906)	
EXPLORER 55 (TRACTORS) 1983-UP		Hydraulic Oil Filter.....	HC-51040	Hydraulic Oil Filter.....	HC-51040
Hydraulic Oil Filter.....	HC-45110	Hydraulic Oil Filter.....	HC-45110	FRUTTETO II 75 (TRACTORS) PERKINS 1000.4 A (S/N: T0-6328)	
Hydraulic Oil Filter.....	HC-51040	EXPLORER 90 II (TRACTORS) PERKINS 1000.4 (S/N: T0-22684)		Hydraulic Oil Filter.....	HC-51040
Hydraulic Oil Filter.....	HC-51040	Hydraulic Oil Filter.....	HC-51040	FRUTTETO II 75 (TRACTORS) S/N: 6329-UP	
EXPLORER 75 (TRACTORS) 1984-UP		Hydraulic Oil Filter.....	HC-45110	Hydraulic Oil Filter.....	HC-51040
Hydraulic Oil Filter.....	HC-51040	EXPLORER 90 SP (TRACTORS) S/N: 1059-UP		FRUTTETO II 85 (TRACTORS) PERKINS 1000.4 AT (S/N: T0-3236)	
Hydraulic Oil Filter.....	HC-45110	Hydraulic Oil Filter.....	HC-45110	Hydraulic Oil Filter.....	HC-51040
EXPLORER 90 (TRACTORS) 1987-UP		EXPLORER 90 SP (TRACTORS) S/N: 2500-UP		FRUTTETO II 85 (TRACTORS) S/N: 3237-UP	
Hydraulic Oil Filter.....	HC-51040	Hydraulic Oil Filter.....	HC-45110	Hydraulic Oil Filter.....	HC-51040
Hydraulic Oil Filter.....	HC-45110	EXPLORER 90 SP (TRACTORS) S/N: T0-1058		GALAXY 170 (TRACTORS) SAME 1056 PT INTERCOOLER , 1990	
EXPLORER 70 II (TRACTORS)		Hydraulic Oil Filter.....	HC-45110	Hydraulic Oil Filter.....	HC-45110
Hydraulic Oil Filter.....	HC-51040	Hydraulic Oil Filter.....	HC-51040	Hydraulic Oil Filter.....	HC-51040
EXPLORER 70 SP (TRACTORS) 1986-UP		EXPLORER 90 SP (TRACTORS) S/N: T0-1058			
Hydraulic Oil Filter.....	HC-45110	Hydraulic Oil Filter.....	HC-45110		
		Hydraulic Oil Filter.....	HC-51040		



ENGINE APPLICATION

MODEL/APPLICATION	SAKURA NO	MODEL/APPLICATION	SAKURA NO	MODEL/APPLICATION	SAKURA NO
SAME, HURLIMANN, LAMBORGHINI		SAME, HURLIMANN, LAMBORGHINI			
GALAXY 170 (TRACTORS)		SOLAR 50 (TRACTORS)		SY205C (EXCAVATORS) MITSUBISHI 6D34-TL	
Hydraulic Oil Filter.....	HC-51040	Hydraulic Oil Filter.....	HC-51040	Hydraulic Oil Filter.....	H-57060
				Hydraulic Oil Filter.....	H-57050
LASER 100 (TRACTORS) SAME 1056P		SOLAR 50 (TRACTORS) S/N: 5300-UP		SY200C (EXCAVATORS) 6BTA5.9-C	
Hydraulic Oil Filter.....	HC-51040	Hydraulic Oil Filter.....	HC-51040	Hydraulic Oil Filter.....	H-85590
				Hydraulic Oil Filter Return.....	H-7981
LASER 150 (TRACTORS) SAME 1056 PS TURBO		SOLAR 50 (TRACTORS) S/N: T0-5299		SY205C-8 (EXCAVATORS) 6D34TL-20	
Hydraulic Oil Filter.....	HC-51040	Hydraulic Oil Filter.....	HC-51040	Hydraulic Oil Filter Return.....	H-7981
LASER 90 (TRACTORS)		SOLAR 60 (TRACTORS)		SY215C-8 (EXCAVATORS) 6D34-TL	
Hydraulic Oil Filter.....	HC-51040	Hydraulic Oil Filter.....	HC-51040	Hydraulic Oil Filter Return.....	H-7981
LASER 85 TRANSPORTER (TRACTORS)		SOLAR 60 (TRACTORS) S/N: 4500-UP		SY425C (EXCAVATORS) ISUZU	
Hydraulic Oil Filter.....	HC-51040	Hydraulic Oil Filter.....	HC-51040	Hydraulic Oil Filter.....	H-42180
LEOPARD C (TRACTORS) 1980-UP		SOLAR 60 (TRACTORS) S/N: T0-4499		SY465C (EXCAVATORS) ISUZU	
Hydraulic Oil Filter.....	HC-45110	Hydraulic Oil Filter.....	HC-51040	Hydraulic Oil Filter.....	H-42180
MERCURY 85 EXP. (TRACTORS)		SOLARIS 25 (TRACTORS) MITSUBISHI K3FD		SY75C-9 (EXCAVATORS) 4JG1	
Hydraulic Oil Filter.....	HC-51040	Hydraulic Oil Filter.....	HC-51040	Hydraulic Oil Filter.....	H-2721
MERCURY 85 SP. (TRACTORS)		SOLARIS 35 WIND (TRACTORS) MITSUBISHI		SCANIA	
Hydraulic Oil Filter.....	HC-51040	Hydraulic Oil Filter.....	HC-51040	164 SERIES 480 HP (TRUCKS) SCANIA DC16.01 , 2000-2004	
ROW CROP 80 (TRACTORS)		SOLARIS 35 WIND (TRACTORS) SAME		Hydraulic Oil Filter.....	H-8301
Hydraulic Oil Filter.....	HC-51040	Hydraulic Oil Filter.....	HC-51040	Hydraulic Oil Filter.....	HC-7920
ROW CROP 85 (TRACTORS)		SOLARIS 45 (TRACTORS) MITSUBISHI		164 SERIES 480 HP (TRUCKS) SCANIA DC16.02 , 2000-2004	
Hydraulic Oil Filter.....	HC-51040	Hydraulic Oil Filter.....	HC-51040	Hydraulic Oil Filter.....	HC-7920
ROW CROP 90 (TRACTORS)		VIGNERON 62 (TRACTORS)		Hydraulic Oil Filter.....	H-8301
Hydraulic Oil Filter.....	HC-45110	Hydraulic Oil Filter.....	HC-51040	CENTURY 12.35 (BUSES) SCANIA DSC11 (S/N: EURO 3-UP) , 1999-UP	
SILVER 100.4 (TRACTORS) PERKINS 1000.4 AT , 1999-UP		VIGNERON 70 (TRACTORS)		Hydraulic Oil Filter.....	H-8301
Hydraulic Oil Filter.....	HC-51040	Hydraulic Oil Filter.....	HC-51040	CENTURY 12.35 (BUSES) SCANIA DSC12 (S/N: EURO 3-UP) , 1999-UP	
SILVER 100.6 (TRACTORS) PERKINS 1000.6 A		SAMSUNG		Hydraulic Oil Filter.....	H-8301
Hydraulic Oil Filter.....	HC-51040	LC240 (EXCAVATORS)		CENTURY 12.37 (BUSES) SCANIA DSC12 , 2000-UP	
SILVER 110 (TRACTORS) PERKINS 1000.4 WT , 1999-UP		Hydraulic Oil Filter.....	HC-8805	Hydraulic Oil Filter.....	H-8301
Hydraulic Oil Filter.....	HC-51040	SE280LC2 (EXCAVATORS)		CENTURY 12.85 (BUSES) SCANIA DSC11 , 2002-UP	
SILVER 130 (TRACTORS) PERKINS 1000.6 WT , 1999-UP		Hydraulic Oil Filter.....	HC-8805	Hydraulic Oil Filter.....	H-8301
Hydraulic Oil Filter.....	HC-51040	Hydraulic Oil Filter.....	H-2719	CENTURY 12.85 (BUSES) SCANIA DSC12 , 2002-UP	
SILVER 80 (TRACTORS) PERKINS 1000.4		SE350LC2 (EXCAVATORS) CUMMINS LTA10		Hydraulic Oil Filter.....	H-8301
Hydraulic Oil Filter.....	HC-51040	Hydraulic Oil Filter.....	H-2709	CENTURY 13.37 (BUSES) SCANIA DSC12 (S/N: EURO 3-UP) , 2002-UP	
SILVER 90 (TRACTORS) PERKINS 1000.4 AT , 1999-UP		SL150 (EXCAVATORS) CUMMINS 6BT5.9		Hydraulic Oil Filter.....	H-8301
Hydraulic Oil Filter.....	HC-51040	Hydraulic Oil Filter Transmission...	HC-2701	G230 (TRUCKS) SCANIA DC9 (S/N: EURO4-UP) , 2007-UP	
		SANY			



ENGINE APPLICATION

MODEL/APPLICATION	SAKURA NO	MODEL/APPLICATION	SAKURA NO	MODEL/APPLICATION	SAKURA NO
SCANIA					
G230 (TRUCKS) SCANIA DC9 (S/N: EURO4-UP) , 2007-UP Hydraulic Oil Filter.....	H-8301	K124 (BUSES) SCANIA D5C12 , 1998-UP Hydraulic Oil Filter.....	H-8301	Hydraulic Oil Filter.....	HC-7920
G340 (TRUCKS) SCANIA DC12 (S/N: EURO 4-UP) , 2007-UP Hydraulic Oil Filter.....	H-8301	L114-GR900/GRS890/GRS900 (TRUCKS) Hydraulic Oil Filter.....	HC-7920	P124 (TRUCKS) SCANIA DC12 (S/N: EURO3-UP) , 1999-2004 Hydraulic Oil Filter.....	H-8301
G380 (TRUCKS) SCANIA DC12 (S/N: EURO 5-UP) , 2007-UP Hydraulic Oil Filter.....	H-8301	L94 (TRUCKS) SCANIA 2 Hydraulic Oil Filter.....	H-8301	Hydraulic Oil Filter.....	HC-7920
G420 (TRUCKS) SCANIA DT12 (S/N: EURO 4-UP) , 2007-UP Hydraulic Oil Filter.....	H-8301	M114-GR900/GRS890/GRS900 (TRUCKS) Hydraulic Oil Filter.....	HC-7920	P124 (TRUCKS) SCANIA D5C12 (S/N: EURO2-UP) , 1996-2004 Hydraulic Oil Filter.....	H-8301
IRIZAR I4 (BUSES) SCANIA DC9 , 2008-UP Hydraulic Oil Filter.....	H-8301	M94 (TRUCKS) 1996 Hydraulic Oil Filter.....	H-8301	Hydraulic Oil Filter.....	HC-7920
IRIZAR N94 E/EB/IB/UB (BUSES) SCANIA DC9 (S/N: EURO4-UP) , 2005-UP Hydraulic Oil Filter.....	HC-7920	M94-GR801/900(R)/GRS890/900 (TRUCKS) Hydraulic Oil Filter.....	HC-7920	P230 (TRUCKS) SCANIA DC9 (S/N: EURO 5-UP) , 2007-UP Hydraulic Oil Filter.....	H-8301
IRIZAR N94 E/EB/IB/UB (BUSES) SCANIA DC9 (S/N: EURO3-UP) , 1999-UP Hydraulic Oil Filter.....	H-8301	OMNICITY 11 (BUSES) SCANIA DC9 , 2008-UP Hydraulic Oil Filter.....	H-8301	P230 (TRUCKS) SCANIA DC9-230 (S/N: EURO4-UP) , 2005-UP Hydraulic Oil Filter.....	H-8301
IRIZAR N94 EB/IB/UB (BUSES) SCANIA D5C9 (S/N: EURO2-UP) , 1997-UP Hydraulic Oil Filter.....	HC-7920	OMNICITY 11 (BUSES) SCANIA DC9 , 2006-UP Hydraulic Oil Filter.....	H-8301	Hydraulic Oil Filter.....	HC-7920
IRIZAR PB (BUSES) SCANIA D5C12 (S/N: EURO 3-UP) , 2002-2006 Hydraulic Oil Filter.....	H-8301	OMNIEXPRESS (BUSES) SCANIA DC12 , 2007-UP Hydraulic Oil Filter.....	H-8301	P230 (TRUCKS) w/DC9 16-230 (Euro 4) Eng. , 2005 Hydraulic Oil Filter.....	HC-7920
IRIZAR PB GT 13.9 (BUSES) SCANIA DC13 , 2008-UP Hydraulic Oil Filter.....	H-8301	OMNILINE 11 (BUSES) SCANIA DC9 , 2006-UP Hydraulic Oil Filter.....	HC-7920	P230 (TRUCKS) w/DC9 13-230 (Euro 3) Eng. , 2004 Hydraulic Oil Filter.....	HC-7920
IRIZAR PB GT 13.9 (BUSES) SCANIA DT12 , 2007-UP Hydraulic Oil Filter.....	H-8301	OMNILINE 11 (BUSES) SCANIA DC9 , 2006-UP Hydraulic Oil Filter.....	H-8301	P270 (TRUCKS) SCANIA DC9-270 (S/N: EURO4-UP) , 2005-UP Hydraulic Oil Filter.....	H-8301
IRIZAR PB GT 13.9 (BUSES) SCANIA DT12 , 2006-UP Hydraulic Oil Filter.....	H-8301	OMNILINK 11 (BUSES) SCANIA DC9 , 2006-UP Hydraulic Oil Filter.....	HC-7920	Hydraulic Oil Filter.....	HC-7920
K114 (BUSES) SCANIA DC11 (S/N: EURO3-UP) , 1999-UP Hydraulic Oil Filter.....	HC-7920	OMNILINE 11 (BUSES) SCANIA DC9 , 2006-UP Hydraulic Oil Filter.....	H-8301	P280 (TRUCKS) w/DC09 (Euro 6) , 2013 Hydraulic Oil Filter.....	HC-7920
K114 (BUSES) SCANIA D5C11 , 1998-UP Hydraulic Oil Filter.....	HC-7920	OMNILINE 11 (BUSES) SCANIA DC9 , 2006-UP Hydraulic Oil Filter.....	H-8301	P310 (TRUCKS) SCANIA DC9-310 (S/N: EURO4-UP) , 2005-UP Hydraulic Oil Filter.....	H-8301
K114 IB (BUSES) SCANIA DC11 Hydraulic Oil Filter.....	H-8301	OMNILINE 11 (BUSES) SCANIA DC9 , 2006-UP Hydraulic Oil Filter.....	HC-7920	Hydraulic Oil Filter.....	HC-7920
	HC-7920	OMNILINE 11 (BUSES) SCANIA DC9 , 2006-UP Hydraulic Oil Filter.....	H-8301	P320 (TRUCKS) w/DC09 (Euro 6) , 2013 Hydraulic Oil Filter.....	HC-7920
		P114 (TRUCKS) SCANIA DC11 (S/N: EURO3-UP) , 1999-2004 Hydraulic Oil Filter.....	HC-7920	P340 (TRUCKS) SCANIA DC12-340 (S/N: EURO4-UP) , 2006-UP Hydraulic Oil Filter.....	H-8301
		Hydraulic Oil Filter.....	H-8301	Hydraulic Oil Filter.....	HC-7920
		P114 (TRUCKS) SCANIA D5C11 (S/N: EURO2-UP) , 1996-2004 Hydraulic Oil Filter.....	H-8301	P360 (TRUCKS) w/DC09 (Euro 6) , 2013 Hydraulic Oil Filter.....	HC-7920
		Hydraulic Oil Filter.....	HC-7920	P380 (TRUCKS) SCANIA DC12 (S/N: EURO 5-UP) , 2007-UP Hydraulic Oil Filter.....	H-8301
		P124 (TRUCKS) SCANIA DC1203 (S/N: EURO3-1-UP) , 2002-2004 Hydraulic Oil Filter.....	HC-7920	P380 (TRUCKS) SCANIA DC12-380 (S/N: EURO4-UP) , 2005-UP Hydraulic Oil Filter.....	H-8301
		Hydraulic Oil Filter.....	H-8301	Hydraulic Oil Filter.....	HC-7920
		P124 (TRUCKS) SCANIA DT1202/08 (S/N: EURO3-UP) , 2001-2004			



ENGINE APPLICATION

MODEL/APPLICATION	SAKURA NO	MODEL/APPLICATION	SAKURA NO	MODEL/APPLICATION	SAKURA NO
SCANIA					
P 420 (TRUCKS) SCANIA DC12-420 (S/N: EURO5-UP) , 2006-UP		R340 (TRUCKS) SCANIA DC12-340 (S/N: EURO4-UP) , 2005-UP		R480 (TRUCKS) w/DT12 17-480 (Euro 4) Eng. , 2006	
Hydraulic Oil Filter.....	HC-7920	Hydraulic Oil Filter.....	HC-7920	Hydraulic Oil Filter.....	HC-7920
Hydraulic Oil Filter.....	H-8301	Hydraulic Oil Filter.....	H-8301		
P94 (TRUCKS) SCANIA DC9 , 1995-2004		R340 (TRUCKS) SCANIA DC11-340 (S/N: EURO3-UP) , 2004-UP		R500 (TRUCKS) SCANIA DC16-500 (S/N: EURO4-UP) , 2006-UP	
Hydraulic Oil Filter.....	HC-7920	Hydraulic Oil Filter.....	H-8301	Hydraulic Oil Filter.....	HC-7920
Hydraulic Oil Filter.....	H-8301	Hydraulic Oil Filter.....	HC-7920	Hydraulic Oil Filter.....	H-8301
P94 (TRUCKS) SCANIA DSC9 , 1995-2004		R360 (TRUCKS) SCANIA DC13 (S/N: EURO 5-UP) , 2007-UP		R500 (TRUCKS) SCANIA DC16-500 (S/N: EURO5-UP) , 2006-UP	
Hydraulic Oil Filter.....	HC-7920	Hydraulic Oil Filter.....	H-8301	Hydraulic Oil Filter.....	H-8301
Hydraulic Oil Filter.....	H-8301	Hydraulic Oil Filter.....	H-8301	Hydraulic Oil Filter.....	HC-7920
P94G (TRUCKS)		R380 (TRUCKS) SCANIA DC12-380 (S/N: EURO4-UP) , 2005-UP		R500 (TRUCKS) SCANIA DC16-500 (S/N: EURO3-UP) , 2004-UP	
Hydraulic Oil Filter.....	HC-7920	Hydraulic Oil Filter.....	H-8301	Hydraulic Oil Filter.....	HC-7920
Hydraulic Oil Filter.....	H-8301	Hydraulic Oil Filter.....	HC-7920	Hydraulic Oil Filter.....	H-8301
R144 (TRUCKS) SCANIA 8 CYL , 1996-2001		R380 (TRUCKS) SCANIA DC11-380 (S/N: EURO3-UP) , 2004-UP		R560 (TRUCKS) SCANIA DC16 18-560 (S/N: EURO 5-UP) , 2007-UP	
Hydraulic Oil Filter.....	H-8301	Hydraulic Oil Filter.....	H-8301	Hydraulic Oil Filter.....	H-8301
Hydraulic Oil Filter.....	HC-7920	Hydraulic Oil Filter.....	HC-7920	Hydraulic Oil Filter.....	HC-7920
R164 V8 (TRUCKS) SCANIA DC16.01 , 2000-2004		R420 (TRUCKS) SCANIA DC12-420 (S/N: EURO5-UP) , 2006-UP		R560 (TRUCKS) SCANIA DC16 05-560 (S/N: EURO4-UP) , 2006-UP	
Hydraulic Oil Filter.....	HC-7920	Hydraulic Oil Filter.....	H-8301	Hydraulic Oil Filter.....	H-8301
Hydraulic Oil Filter.....	H-8301	Hydraulic Oil Filter.....	HC-7920	Hydraulic Oil Filter.....	HC-7920
R164 V8 (TRUCKS) SCANIA DC16.02 , 2000-2004		R420 (TRUCKS) SCANIA DC12-420 (S/N: EURO 3-UP) , 2004-UP		R580 (TRUCKS) SCANIA DC1603-580 (S/N: EURO3-UP) , 2004-UP	
Hydraulic Oil Filter.....	H-8301	Hydraulic Oil Filter.....	HC-7920	Hydraulic Oil Filter.....	HC-7920
Hydraulic Oil Filter.....	HC-7920	Hydraulic Oil Filter.....	H-8301	Hydraulic Oil Filter.....	H-8301
R230 (TRUCKS) SCANIA DC9-230 (S/N: EURO4-UP) , 2005-UP		R420 (TRUCKS) SCANIA DT12-420 (S/N: EURO 4-UP) , 2004-UP		R620 (TRUCKS) SCANIA DC16 (S/N: EURO 5-UP) , 2007-UP	
Hydraulic Oil Filter.....	H-8301	Hydraulic Oil Filter.....	H-8301	Hydraulic Oil Filter.....	H-8301
Hydraulic Oil Filter.....	HC-7920	Hydraulic Oil Filter.....	HC-7920		
R230 (TRUCKS) SCANIA DC9-230 (S/N: EURO3-UP) , 2004-UP		R440 (TRUCKS) w/DC13 (Euro 6) Eng , 2012		R94 (TRUCKS) SCANIA DC9 (S/N: EURO3-UP) , 1999-2004	
Hydraulic Oil Filter.....	H-8301	Hydraulic Oil Filter.....	HC-7920	Hydraulic Oil Filter.....	H-8301
Hydraulic Oil Filter.....	HC-7920	Hydraulic Oil Filter.....	HC-7920	Hydraulic Oil Filter.....	HC-7920
R270 (TRUCKS) SCANIA DC9-270 (S/N: EURO4-UP) , 2005-UP		R440 (TRUCKS) w/DC13 (Euro 6) Eng. , 2012		R94 (TRUCKS) SCANIA 6 CYL , 1996-2004	
Hydraulic Oil Filter.....	H-8301	Hydraulic Oil Filter.....	HC-7920	Hydraulic Oil Filter.....	H-8301
Hydraulic Oil Filter.....	HC-7920	Hydraulic Oil Filter.....	HC-7920	Hydraulic Oil Filter.....	HC-7920
R270 (TRUCKS) SCANIA DC9-270 (S/N: EURO3-UP) , 2004-UP		R470 (TRUCKS) SCANIA DT12-470 (S/N: EURO4-UP) , 2005-UP		T113 (TRUCKS) SCANIA DS11 TURBO	
Hydraulic Oil Filter.....	H-8301	Hydraulic Oil Filter.....	H-8301	Hydraulic Oil Filter.....	HC-7920
Hydraulic Oil Filter.....	HC-7920	Hydraulic Oil Filter.....	HC-7920		
R310 (TRUCKS) SCANIA DC9-310 (S/N: EURO4-UP) , 2005-UP		R470 (TRUCKS) SCANIA DT12-470 (S/N: EURO3-UP) , 2004-UP		T114 (TRUCKS) SCANIA DC11 (S/N: EURO3-UP) , 1998-2004	
Hydraulic Oil Filter.....	H-8301	Hydraulic Oil Filter.....	H-8301	Hydraulic Oil Filter.....	H-8301
Hydraulic Oil Filter.....	HC-7920	Hydraulic Oil Filter.....	HC-7920	Hydraulic Oil Filter.....	HC-7920
R310 (TRUCKS) SCANIA DC9-310 (S/N: EURO3-UP) , 2004-UP		R480 (TRUCKS) w/DC13 (Euro 6) Eng. , 2012		T124 (TRUCKS) 2000-UP	
Hydraulic Oil Filter.....	H-8301	Hydraulic Oil Filter.....	HC-7920	Hydraulic Oil Filter.....	H-8301
Hydraulic Oil Filter.....	HC-7920	Hydraulic Oil Filter.....	HC-7920		
R310 (TRUCKS) SCANIA DC9-310 (S/N: EURO3-UP) , 2004-UP		R480 (TRUCKS) SCANIA DT12-480 (S/N: EURO4-UP) , 2006-UP		T143 (TRUCKS) SCANIA DS14	
Hydraulic Oil Filter.....	H-8301	Hydraulic Oil Filter.....	H-8301	Hydraulic Oil Filter.....	HC-7920
Hydraulic Oil Filter.....	HC-7920	Hydraulic Oil Filter.....	HC-7920		



ENGINE APPLICATION

MODEL/APPLICATION	SAKURA NO	MODEL/APPLICATION	SAKURA NO	MODEL/APPLICATION	SAKURA NO
SCANIA		SHANTUI		STEIGER	
T93 (TRUCKS) SCANIA D59		Hydraulic Oil Filter.....	H-5606	Hydraulic Oil Filter.....	HC-5508
		SOLARIS BUS (PL)		BEARCAT (TRACTORS) STEIGER 3160	
Hydraulic Oil Filter.....	HC-7920	URBINO 12 (BUSES) MAN D0824 LOH17 , 1999-UP		Hydraulic Oil Filter.....	HC-1903
T94 (TRUCKS) SCANIA , 1996-2004		Hydraulic Oil Filter Transmission....	H-7102	Hydraulic Oil Filter.....	H-79411
Hydraulic Oil Filter.....	H-8301	URBINO 15 (BUSES) MAN D0826 LOH18 , 1999-UP		BEARCAT II (TRACTORS) CAT 3208	
Hydraulic Oil Filter.....	HC-7920	Hydraulic Oil Filter Transmission....	H-7102	Hydraulic Oil Filter.....	HC-1903
SCHAEFF		URBINO 18 (BUSES) MAN D0824 LOH25 , 1999-UP		BEARCAT II (TRACTORS) CAT 3160	
HML30F (EXCAVATORS) PERKINS , 1987-UP		Hydraulic Oil Filter Transmission....	H-7102	Hydraulic Oil Filter.....	HC-1903
Hydraulic Oil Filter.....	H-62080	URBINO 9 (BUSES) MAN D0824 LOH05 , 1999-UP		BEARCAT III ST-220 (TRACTORS) CUMMINS	
Hydraulic Oil Filter.....	H-4904	Hydraulic Oil Filter Transmission....	H-7102	Hydraulic Oil Filter.....	HC-5508
HML31CI (EXCAVATORS) KHD		URBINO 18 (BUSES) MAN D0824 LOH25 , 1999-UP		Hydraulic Oil Filter.....	HC-1903
Hydraulic Oil Filter.....	H-4904	Hydraulic Oil Filter Transmission....	H-7102	BEARCAT III ST-225 (TRACTORS) CAT 3306	
Hydraulic Oil Filter.....	H-62080	URBINO 9 (BUSES) MAN D0824 LOH05 , 1999-UP		Hydraulic Oil Filter.....	HC-1903
SCHLUETER		Hydraulic Oil Filter Transmission....	H-7102	BEARCAT III ST-225 (TRACTORS) CAT 3306	
PROFI TRAC 2500VL (TRACTORS)		1580 (TRACTORS)		Hydraulic Oil Filter.....	HC-1903
Hydraulic Oil Filter Transmission...	HC-2701	Hydraulic Oil Filter.....	HC-45110	Hydraulic Oil Filter.....	H-51170
Hydraulic Oil Filter.....	HC-6802	SPIERINGS		BEARCAT IV CM225 (TRACTORS) CAT 3306	
PROFI TRAC 2200TVL (TRACTORS)		SK345 (CRANES) DAF DHS825 , 1990-UP		Hydraulic Oil Filter.....	HC-1903
Hydraulic Oil Filter Transmission...	HC-2701	Hydraulic Oil Filter.....	HC-7906	Hydraulic Oil Filter.....	H-51170
Hydraulic Oil Filter.....	HC-6802	SK477 (CRANES) DAF WS268L , 1995-UP		BEARCAT IV KM225 (TRACTORS) CUMMINS L10	
SUPER 3000TVL (TRACTORS)		Hydraulic Oil Filter.....	HC-7906	Hydraulic Oil Filter.....	H-51170
Hydraulic Oil Filter.....	HC-6802	SK477 (CRANES) DAF WS268L , 1994-UP		Hydraulic Oil Filter.....	HC-1903
SUPER TRAC 2500VL (TRACTORS)		Hydraulic Oil Filter.....	HC-7906	CA, CU INDUSTRIAL SERIES (TRACTORS) CUMMINS ENGINE	
Hydraulic Oil Filter Transmission...	HC-2701	SK598 (CRANES) DAF XF315M , 1998-UP		Hydraulic Oil Filter Transmission...	H-65030
Hydraulic Oil Filter.....	HC-6802	Hydraulic Oil Filter.....	HC-7906	Hydraulic Oil Filter.....	H-51170
SCOOP-MOBILE		STEIGER		CA, CU INDUSTRIAL SERIES (TRACTORS)	
CEMENT MIXERS (MIXERS) CUMMINS		1700 (TRACTORS) GMC 6V-53N DIESEL		Hydraulic Oil Filter.....	H-51170
Hydraulic Oil Filter Transmission...	H-65030	Hydraulic Oil Filter.....	H-51170	Hydraulic Oil Filter Transmission...	H-65030
SEDDON-ATKINSON		2200 (TRACTORS) GMC 6V-71N DIESEL		Cougar (TRACTORS) CAT D333	
401 SERIES T17C (TRUCKS) CUMMINS 250 TURBO E290 , 1980-UP		Hydraulic Oil Filter.....	H-51170	Hydraulic Oil Filter.....	HC-1903
Hydraulic Oil Filter Transmission...	H-65030	3300 (TRACTORS) GMC 8V-71N DIESEL		Cougar (TRACTORS) CATERPILLAR	
AB1500 (TRUCKS)		Hydraulic Oil Filter.....	H-51170	Hydraulic Oil Filter.....	HC-5508
Hydraulic Oil Filter.....	H-71140	BEARCAT (TRACTORS) CAT 3150		Cougar (TRACTORS) CUMMINS ENGINE	
SHANTUI		Hydraulic Oil Filter.....	H-79411	Hydraulic Oil Filter.....	HC-5508
SD22 (DOZERS) CUMMINS NTA855-C280		Hydraulic Oil Filter.....	HC-1903	COUGAR II (TRACTORS) CAT 3306	
Hydraulic Oil Filter.....	H-5606	BEARCAT (TRACTORS) CATERPILLAR		Hydraulic Oil Filter.....	HC-1903
Hydraulic Oil Filter.....	H-5610	Hydraulic Oil Filter.....	HC-5508	COUGAR II (TRACTORS) STEIGER D333	
SD32 (DOZERS) CUMMINS NTA855-C360		BEARCAT (TRACTORS) CUMMINS		Hydraulic Oil Filter.....	HC-1903
Hydraulic Oil Filter.....	H-5610	Hydraulic Oil Filter.....	HC-5508	COUGAR III PT-270 (TRACTORS) CAT 3306	



ENGINE APPLICATION

MODEL/APPLICATION	SAKURA NO	MODEL/APPLICATION	SAKURA NO	MODEL/APPLICATION	SAKURA NO
STEIGER		STEIGER		STEIGER	
COUGAR III PT-270 (TRACTORS) CAT 3306		PANTHER 1000 KP1325 (TRACTORS) CUMMINS NTA-855		SUPER WILDCAT (TRACTORS) CAT 3150	
Hydraulic Oil Filter.....	HC-1903	Hydraulic Oil Filter.....	H-51170	Hydraulic Oil Filter.....	H-79411
Hydraulic Oil Filter.....	H-51170			Hydraulic Oil Filter.....	HC-1903
COUGAR III ST-250 (TRACTORS) CAT 3306		PANTHER II (TRACTORS) CUMMINS		SUPER WILDCAT (TRACTORS) STEIGER 3160	
Hydraulic Oil Filter.....	HC-1903	Hydraulic Oil Filter.....	HC-1903	Hydraulic Oil Filter.....	H-79411
				Hydraulic Oil Filter.....	HC-1903
COUGAR III ST-251 (TRACTORS) CUMMINS		PANTHER III PT-350 (TRACTORS) CUMMINS V-903		SUPER WILDCAT II (TRACTORS) CAT 3150	
Hydraulic Oil Filter.....	HC-1903	Hydraulic Oil Filter.....	HC-1903	Hydraulic Oil Filter.....	HC-1903
		Hydraulic Oil Filter.....	H-51170		
COUGAR III ST-270 (TRACTORS) CAT 3306		PANTHER III ST-325 (TRACTORS) CAT 3406		SUPER WILDCAT II (TRACTORS) STEIGER 3160	
Hydraulic Oil Filter.....	HC-1903	Hydraulic Oil Filter.....	HC-1903	Hydraulic Oil Filter.....	HC-1903
				Hydraulic Oil Filter.....	HC-1903
COUGAR IV CM280 (TRACTORS) CAT 3406		PANTHER IV SM325 (TRACTORS) KOMATSU SAD125		TIGER III ST-450 (TRACTORS) CUMMINS KT-1150	
Hydraulic Oil Filter.....	HC-1903	Hydraulic Oil Filter.....	HC-1903	Hydraulic Oil Filter Transmission...	H-65030
COUGAR IV KM280 (TRACTORS) CUMMINS NT-855		PANTHER III (TRACTORS) CUMMINS		TIGER ST-450 (TRACTORS) CAT 3408	
Hydraulic Oil Filter.....	HC-1903	Hydraulic Oil Filter.....	HC-1903	Hydraulic Oil Filter Transmission...	H-65030
COUGAR ST-280 (TRACTORS) CAT 3406		PT-225 (TRACTORS)		TIGER ST470 (TRACTORS) CUMMINS 6 CYL	
Hydraulic Oil Filter.....	HC-1903	Hydraulic Oil Filter.....	HC-1903	Hydraulic Oil Filter Transmission...	H-65030
Hydraulic Oil Filter.....	HC-5511	Hydraulic Oil Filter.....	H-51170		
				TURBO TIGER (TRACTORS) CUMMINS V-903	
COUGAR ST-280 (TRACTORS) CUMMINS NT-855		PTA-251 (TRACTORS)		Hydraulic Oil Filter.....	HC-1903
Hydraulic Oil Filter.....	HC-1903	Hydraulic Oil Filter.....	HC-1903		
				TURBO TIGER II (TRACTORS) CUMMINS V-903	
CP & KP PANTHER 1000 SERIES (TRACTORS) CUMMINS		PTA-270 (TRACTORS)		Hydraulic Oil Filter.....	HC-1903
Hydraulic Oil Filter Transmission...	H-65030	Hydraulic Oil Filter.....	HC-1903		
Hydraulic Oil Filter.....	H-51170			Wildcat (TRACTORS) CAT 3150	
				Hydraulic Oil Filter.....	H-79411
CP & KP PANTHER 1000 SERIES (TRACTORS)		PTA-280 (TRACTORS) CATERPILLAR		Hydraulic Oil Filter.....	HC-1903
Hydraulic Oil Filter Transmission...	H-65030	Hydraulic Oil Filter.....	HC-1903		
Hydraulic Oil Filter.....	H-51170			Wildcat (TRACTORS) STEIGER 3160	
		PTA-280 (TRACTORS) CUMMINS		Hydraulic Oil Filter.....	HC-1903
CS280 (TRACTORS)		Hydraulic Oil Filter.....	HC-1903	Hydraulic Oil Filter.....	H-79411
Hydraulic Oil Filter.....	HC-1903			Hydraulic Oil Filter.....	HC-1903
		PTA-296 (TRACTORS) CUMMINS NTA-855			
KS280 (TRACTORS)		Hydraulic Oil Filter.....	HC-1903	WILDCAT III (ST-210) (TRACTORS) CAT 3208	
Hydraulic Oil Filter.....	HC-1903			Hydraulic Oil Filter.....	HC-1903
		PTA-296 (TRACTORS) CUMMINS VT-903			
PANTHER/LION (TRACTORS) CAT 3406		Hydraulic Oil Filter.....	HC-1903	STEYR DAIMLER PUCH	
Hydraulic Oil Filter.....	HC-5508			8110 (TRACTORS)	
Hydraulic Oil Filter.....	H-51170	PTA-325 (TRACTORS) CAT DIESEL		Hydraulic Oil Filter.....	HC-6802
		Hydraulic Oil Filter.....	HC-1903		
PANTHER/LION (TRACTORS) CUMMINS NT-855		PUMA 1000 (TRACTORS) CONSOLDI 8.3L		8320 (TRACTORS)	
Hydraulic Oil Filter.....	H-51170	Hydraulic Oil Filter.....	HC-5508	Hydraulic Oil Filter.....	HC-6801
Hydraulic Oil Filter.....	HC-5508				
PANTHER 1000 (TRACTORS) CAT 3406		ST-350 (TRACTORS)		9200 (TRACTORS) CUMMINS 6CT8.3	
Hydraulic Oil Filter.....	H-51170	Hydraulic Oil Filter.....	HC-1903	Hydraulic Oil Filter.....	HC-5508
Hydraulic Oil Filter.....	HC-1903				



ENGINE APPLICATION

MODEL/APPLICATION	SAKURA NO	MODEL/APPLICATION	SAKURA NO	MODEL/APPLICATION	SAKURA NO
SULLAIR		SUMITOMO		SUMITOMO	
185HDPQJD (AIR COMPRESSORS) 2007-UP		SH120-2 (EXCAVATORS) 2006-UP		Hydraulic Oil Filter.....	HC-8805
Hydraulic Oil Filter.....	HC-85030	Hydraulic Oil Filter.....	HC-8805	SH200-3 (EXCAVATORS) 2006-UP	
F130E (AIR COMPRESSORS)		Hydraulic Oil Filter.....	H-2719	Hydraulic Oil Filter.....	H-2719
Hydraulic Oil Filter.....	HC-5502	SH100 (EXCAVATORS) 2006-UP		SH220 (EXCAVATORS) S/N: 1105-1303 , 2006-UP	
F150D (AIR COMPRESSORS) DEUTZ F5L413R		Hydraulic Oil Filter.....	H-2719	Hydraulic Oil Filter.....	HC-8805
Hydraulic Oil Filter.....	HC-5502	SH120 (EXCAVATORS) S/N: 3913-3918 , 2006-UP		Hydraulic Oil Filter.....	H-2719
F180D (AIR COMPRESSORS) DEUTZ F6L413R		Hydraulic Oil Filter.....	HC-8805	SH220 (EXCAVATORS) S/N: 1304-1322 , 2006-UP	
Hydraulic Oil Filter.....	HC-5502	Hydraulic Oil Filter.....	H-2719	Hydraulic Oil Filter.....	H-2719
F230D (AIR COMPRESSORS) DEUTZ F8L413V		SH120 (EXCAVATORS) S/N: 3919-UP , 2006-UP		Hydraulic Oil Filter.....	HC-8805
Hydraulic Oil Filter.....	HC-5502	Hydraulic Oil Filter.....	H-2719	SH220 (EXCAVATORS) S/N: 1323-UP , 2006-UP	
F280D (AIR COMPRESSORS) DEUTZ BF8L413		SH120 (EXCAVATORS) S/N: TO-3912 , 2006-UP		Hydraulic Oil Filter.....	HC-8805
Hydraulic Oil Filter.....	HC-5502	Hydraulic Oil Filter.....	H-2719	Hydraulic Oil Filter.....	H-2719
LS 16 (AIR COMPRESSORS) 2006		SH120-3 (EXCAVATORS) 2006-UP		SH220-3 (EXCAVATORS) 2006-UP	
Hydraulic Oil Filter.....	HC-79490	Hydraulic Oil Filter.....	HC-8805	Hydraulic Oil Filter.....	H-2719
LS 16-75H AC SULL (AIR COMPRESSORS) 2010		SH125X-3 (EXCAVATORS) 2006-UP		SH240-3 (EXCAVATORS) 2006-UP	
Hydraulic Oil Filter.....	HC-7973	Hydraulic Oil Filter.....	H-2719	Hydraulic Oil Filter.....	H-2719
LS16-60/75 (AIR COMPRESSORS)		SH125XU-3 (EXCAVATORS) 2006-UP		SH290-3 (EXCAVATORS) 2006-UP	
Hydraulic Oil Filter.....	HC-7973	Hydraulic Oil Filter.....	H-2719	Hydraulic Oil Filter.....	H-2719
LS20S-125/150 (AIR COMPRESSORS) 2011		SH135U-2 (EXCAVATORS) 2006-UP		SH300-2 (EXCAVATORS) 2006-UP	
Hydraulic Oil Filter.....	HC-7973	Hydraulic Oil Filter.....	H-2719	Hydraulic Oil Filter.....	HC-8805
SK110 (AIR COMPRESSORS)		SH145U (EXCAVATORS) 2006-UP		SH330-3 (EXCAVATORS) 2006-UP	
Hydraulic Oil Filter.....	HC-6802	Hydraulic Oil Filter.....	H-2719	Hydraulic Oil Filter.....	H-2719
WS7508 (AIR COMPRESSORS) 2011		SH160-2 (EXCAVATORS) 2006-UP		SH350 (EXCAVATORS) 2006-UP	
Hydraulic Oil Filter.....	HC-79490	Hydraulic Oil Filter.....	HC-8805	Hydraulic Oil Filter.....	HC-8805
WS7508 AC (AIR COMPRESSORS) 2015		Hydraulic Oil Filter.....	H-2719	Hydraulic Oil Filter.....	H-2719
Hydraulic Oil Filter.....	HC-7973	SH200 (EXCAVATORS) S/N: 4925-5156 , 2006-UP		SH350HD-3 (EXCAVATORS) 2006-UP	
WS7508-AC JALL (AIR COMPRESSORS) 2011		Hydraulic Oil Filter.....	HC-8805	Hydraulic Oil Filter.....	H-2719
Hydraulic Oil Filter.....	HC-79490	SH200 (EXCAVATORS) S/N: 5157-UP , 2006-UP		SH400 (EXCAVATORS) 2006-UP	
SUMITOMO		Hydraulic Oil Filter.....	H-2719	Hydraulic Oil Filter.....	HC-8805
LS2600FJ (EQUIPMENT) w/Mitsubishi 4D31T Eng		Hydraulic Oil Filter.....	HC-8805	SH400-2 (EXCAVATORS) 2006-UP	
Hydraulic Oil Filter.....	H-5519	SH200 (EXCAVATORS) S/N: TO-4924 , 2006-UP		Hydraulic Oil Filter.....	HC-8805
LS2650FJ (EQUIPMENT) w/Mitsubishi 4D31T Eng		Hydraulic Oil Filter.....	HC-8805	Hydraulic Oil Filter.....	H-2719
Hydraulic Oil Filter.....	H-5519	SH200-2 (EXCAVATORS) 2006-UP		SH400-3 (EXCAVATORS) 2006-UP	
		Hydraulic Oil Filter.....	H-2719	Hydraulic Oil Filter.....	H-2719



ENGINE APPLICATION

MODEL/APPLICATION	SAKURA NO	MODEL/APPLICATION	SAKURA NO	MODEL/APPLICATION	SAKURA NO
SUMITOMO		TAKEUCHI		TAMROCK	
SH450LHD (EXCAVATORS) 2006-UP		TB020 (EXCAVATORS) YANMAR , 1991-UP		PANTERA 1500 (DRILLING)	
Hydraulic Oil Filter.....	HC-8805	Hydraulic Oil Filter.....	HC-5807	Hydraulic Oil Filter.....	H-5001
Hydraulic Oil Filter.....	H-2719			Hydraulic Oil Filter.....	H-48320
SH60-2 (EXCAVATORS) 2006-UP		TB025 (EXCAVATORS) YANMAR , 1986-1999		RANGER 700 (DRILLING)	
Hydraulic Oil Filter.....	H-2719	Hydraulic Oil Filter.....	HC-5807	Hydraulic Oil Filter.....	H-48320
SH60B (EXCAVATORS) 2006-UP		TB030 (EXCAVATORS)		Hydraulic Oil Filter.....	H-7975
Hydraulic Oil Filter.....	H-2719	Hydraulic Oil Filter.....	HC-5807	Hydraulic Oil Filter.....	H-5001
SH700LHD-3B (EXCAVATORS) 2006-UP		TB035 (EXCAVATORS) YANMAR , 1990-2001		TAYLOR	
Hydraulic Oil Filter.....	H-2719	Hydraulic Oil Filter.....	HC-5807	AT220 (TRACTORS) DETROIT 6-71N	
SH75U (EXCAVATORS) 2006-UP		TB070 (EXCAVATORS) W/NISSAN BD3004 ENG		Hydraulic Oil Filter Transmission...	H-65030
Hydraulic Oil Filter.....	H-2719	Hydraulic Oil Filter.....	H-5519	TAYLOR MACHINE	
SH75X-3 (EXCAVATORS) YANMAR 4TNE98 , 2006-UP		TB070W (EXCAVATORS) W/NISSAN BD3004 ENG		THDC-955 (LOADERS) CUMMINS M11	
Hydraulic Oil Filter.....	H-2719	Hydraulic Oil Filter.....	H-5519	Hydraulic Oil Filter.....	HC-5503
SUNWARD		TB108 (EXCAVATORS) YANMAR 2TNE68-ETBA		Hydraulic Oil Filter.....	HC-1903
SWE90 (EXCAVATORS) V3800-DI-T-E2B		Hydraulic Oil Filter.....	H-2714	TEREX	
Hydraulic Oil Filter Return.....	H-7981	TB108 (EXCAVATORS) YANMAR 2TNV70		15 UPM (LOADERS) DETROIT 4-71	
TADANO		Hydraulic Oil Filter.....	H-2714	Hydraulic Oil Filter Transmission...	H-65030
TL250 (CRANES)		TB15 (EXCAVATORS) YANMAR		16 UPM (LOADERS) DETROIT 4-71	
Hydraulic Oil Filter.....	H-7914	Hydraulic Oil Filter.....	H-2714	Hydraulic Oil Filter Transmission...	H-65030
TR200EXC-3 (CRANES)		Hydraulic Oil Filter.....	HC-5807	17 UPM (LOADERS) DETROIT 6V-53N	
Hydraulic Oil Filter.....	H-7914	TB20R (EXCAVATORS) YANMAR 3TNV76-XTB		Hydraulic Oil Filter Transmission...	H-65030
TAKEUCHI		Hydraulic Oil Filter.....	H-2714	27LOT S-18 (SCRAPERS)	
TB007 (EXCAVATORS) YANMAR , 1995-UP		TB228 (EXCAVATORS) YANMAR		Hydraulic Oil Filter Transmission...	H-65030
Hydraulic Oil Filter.....	H-2714	Hydraulic Oil Filter.....	H-2712	2 UPM (LOADERS) DETROIT 3-53N	
TB015 (EXCAVATORS) YANMAR , 1986-1999		TB23R (EXCAVATORS) YANMAR 3TNV76-XTB		Hydraulic Oil Filter Transmission...	H-65030
Hydraulic Oil Filter.....	H-2714	Hydraulic Oil Filter.....	H-2714	30LOT S-18 (SCRAPERS)	
TB014 (EXCAVATORS) YANMAR 3TNE68-NTB , 1998-UP		TAMROCK		Hydraulic Oil Filter Transmission...	H-65030
Hydraulic Oil Filter.....	H-2714	1100C (DRILLING)		31LOT TS-24 (SCRAPERS)	
TB014 (EXCAVATORS) YANMAR 3TNV70-STB , 1998-UP		Hydraulic Oil Filter.....	H-5001	Hydraulic Oil Filter Transmission...	H-65030
Hydraulic Oil Filter.....	H-2714	CHA800 (DRILLING)		3307 (TRUCKS) DETROIT 12V-71T	
TB016 (EXCAVATORS) YANMAR 3TNE68-NTB , 1998-UP		Hydraulic Oil Filter.....	H-5001	Hydraulic Oil Filter Transmission...	H-65030
Hydraulic Oil Filter.....	H-2714	DINO 500 (DRILLING)		3307 (TRUCKS)	
TB016 (EXCAVATORS) YANMAR 3TNV70-STB , 1998-UP		Hydraulic Oil Filter.....	H-48320	Hydraulic Oil Filter Transmission...	H-65030
Hydraulic Oil Filter.....	H-2714	Hydraulic Oil Filter.....	H-5001	3305 (TRUCKS) DETROIT 8V-71T	
		EJC 30SX (DUMPERS)		Hydraulic Oil Filter Transmission...	H-65030
		Hydraulic Oil Filter.....	HC-5503		



ENGINE APPLICATION

MODEL/APPLICATION	SAKURA NO	MODEL/APPLICATION	SAKURA NO	MODEL/APPLICATION	SAKURA NO
TEREX					
3309 (TRUCKS) DETROITD 16V-71		72-11 (LOADERS) DETROITD 3-71		72-71AA (LOADERS) DETROITD 8V-71	
Hydraulic Oil Filter Transmission...	H-65030	Hydraulic Oil Filter Transmission...	H-65030	Hydraulic Oil Filter Transmission...	H-65030
3310E (TRUCKS) DETROITD 16V-A020130		72-21AA (LOADERS) DETROITD 3-71N		72-81AA (LOADERS) DETROITD 12V-71	
Hydraulic Oil Filter.....	H-7976	Hydraulic Oil Filter Transmission...	H-65030	Hydraulic Oil Filter Transmission...	H-65030
3311 (TRUCKS) DETROITD 16V-71		72-20CA (LOADERS) DETROITD 4-71		7UOT (TRACTORS)	
Hydraulic Oil Filter Transmission...	H-65030	Hydraulic Oil Filter Transmission...	H-65030	Hydraulic Oil Filter Transmission...	H-65030
3311C (TRUCKS) DETROITD 16V-92TA		72-21 (LOADERS) BEDFORD 466		7 UPM (LOADERS)	
Hydraulic Oil Filter Transmission...	H-65030	Hydraulic Oil Filter Transmission...	H-65030	Hydraulic Oil Filter Transmission...	H-65030
3315 (TRUCKS) DETROITD 16V-149T		72-21 (LOADERS) LEYLAND UE400/80		82-20 (CRAWLER DOZERS) DETROITD 6V-71	
Hydraulic Oil Filter Transmission...	H-65030	Hydraulic Oil Filter Transmission...	H-65030	Hydraulic Oil Filter Transmission...	H-65030
39LOST S-24 (SCRAPERS)		72-31 (LOADERS) DETROITD 4-71N		82-30 (CRAWLER DOZERS) DETROITD 6-71	
Hydraulic Oil Filter Transmission...	H-65030	Hydraulic Oil Filter Transmission...	H-65030	Hydraulic Oil Filter Transmission...	H-65030
3UOT S-7 (TRACTORS)		72-30BA (LOADERS) DETROITD 4-71		82-40 (CRAWLER DOZERS) DETROITD 8V-71N	
Hydraulic Oil Filter Transmission...	H-65030	Hydraulic Oil Filter Transmission...	H-65030	Hydraulic Oil Filter Transmission...	H-65030
3 UPM (LOADERS) DETROITD 3-71		72-31F (LOADERS)		82-40DAT (CRAWLER DOZERS) DETROITD 8V-71T	
Hydraulic Oil Filter Transmission...	H-65030	Hydraulic Oil Filter Transmission...	H-65030	Hydraulic Oil Filter Transmission...	H-65030
43LOT TS-24 (SCRAPERS)		72-31M (LOADERS)		82-50 (CRAWLER DOZERS) DETROIT DIESEL	
Hydraulic Oil Filter Transmission...	H-65030	Hydraulic Oil Filter Transmission...	H-65030	Hydraulic Oil Filter Transmission...	H-65030
47LOT TS-32 (SCRAPERS)		72-40 (LOADERS) DETROITD 6V-53N		82-80 (CRAWLER DOZERS) DETROITD 6-71(QTY 2) DIESEL	
Hydraulic Oil Filter Transmission...	H-65030	Hydraulic Oil Filter Transmission...	H-65030	Hydraulic Oil Filter Transmission...	H-65030
49LOT S-34 (SCRAPERS)		72-41 (LOADERS) DETROITD 4-71N		8 UPM (LOADERS) DETROITD 4-71	
Hydraulic Oil Filter Transmission...	H-65030	Hydraulic Oil Filter Transmission...	H-65030	Hydraulic Oil Filter Transmission...	H-65030
4UOT (TRACTORS)		72-51B (LOADERS) DETROIT DIESEL		9 UPM (LOADERS) DETROITD 4-71	
Hydraulic Oil Filter Transmission...	H-65030	Hydraulic Oil Filter Transmission...	H-65030	Hydraulic Oil Filter Transmission...	H-65030
4 UPM (LOADERS)		72-51 (LOADERS) DETROITD 6-71N		C6 (CRAWLER DOZERS) DETROITD 6-71	
Hydraulic Oil Filter Transmission...	H-65030	Hydraulic Oil Filter Transmission...	H-65030	Hydraulic Oil Filter Transmission...	H-65030
5 UPM (LOADERS)		72-61 (LOADERS) DETROITD 8V-71T		C-6-3 (CRAWLER DOZERS) DETROITD 6-71	
Hydraulic Oil Filter Transmission...	H-65030	Hydraulic Oil Filter Transmission...	H-65030	Hydraulic Oil Filter Transmission...	H-65030
6UOT (TRACTORS)		72-71 (LOADERS) DETROITD 8V-71		C-6-4 (CRAWLER DOZERS) DETROITD 6-71	
Hydraulic Oil Filter Transmission...	H-65030	Hydraulic Oil Filter Transmission...	H-65030	Hydraulic Oil Filter Transmission...	H-65030
72-10AA (LOADERS) DETROITD 3-53N		72-71 (LOADERS) TEREX 8V-92T		C-6-5 (CRAWLER DOZERS) DETROITD 6-71	
Hydraulic Oil Filter Transmission...	H-65030	Hydraulic Oil Filter Transmission...	H-65030	Hydraulic Oil Filter Transmission...	H-65030
72-11 (LOADERS) BEDFORD 330		72-71B (LOADERS) DETROITD 8V-92T		L15 (LOADERS) DETROITD 3-71	
Hydraulic Oil Filter Transmission...	H-65030	Hydraulic Oil Filter Transmission...	H-65030	Hydraulic Oil Filter Transmission...	H-65030



ENGINE APPLICATION

MODEL/APPLICATION	SAKURA NO	MODEL/APPLICATION	SAKURA NO	MODEL/APPLICATION	SAKURA NO
TEREX		TEREX		TEREX	
L25 (LOADERS) DETROIT 4-71		TA50E (CRANES)		Hydraulic Oil Filter Transmission...	H-65030
Hydraulic Oil Filter Transmission...	H-65030	Hydraulic Oil Filter.....	HC-7906	TS-24 (SCRAPERS) DETROIT 12V-71N FRONT ENGINE	
R-17 (TRUCKS) CUMMINS		TA50RT (CRANES)		Hydraulic Oil Filter Transmission...	H-65030
Hydraulic Oil Filter Transmission...	H-65030	Hydraulic Oil Filter.....	HC-7906	TS-24 (SCRAPERS) DETROIT 12V-71N REAR ENGINE	
R35 (TRUCKS) DETROIT 12V-71N		TB66 (CRANES)		Hydraulic Oil Filter Transmission...	H-65030
Hydraulic Oil Filter Transmission...	H-65030	Hydraulic Oil Filter.....	HC-62010	TS-24 (SCRAPERS) DETROIT 8V-71N FRONT ENGINE	
R35 (TRUCKS) TEREX 16V-71N		TB85 (CRANES)		Hydraulic Oil Filter Transmission...	H-65030
Hydraulic Oil Filter Transmission...	H-65030	Hydraulic Oil Filter.....	HC-62010	TS-24 (SCRAPERS) DETROIT 8V-71N REAR ENGINE	
S-11E (SCRAPERS) DETROIT 4-71N		TC12 (EXCAVATORS) DETROIT 6-71(QTY 2) DIESEL		Hydraulic Oil Filter Transmission...	H-65030
Hydraulic Oil Filter Transmission...	H-65030	Hydraulic Oil Filter.....	H-7983	TS-32 (SCRAPERS) DETROIT 12V-71T FRONT ENGINE	
S-18 27LOT (SCRAPERS)		TELELIFT 3013 (HANDLER TELESCOPIC) PERKINS 1004-42		Hydraulic Oil Filter Transmission...	H-65030
Hydraulic Oil Filter Transmission...	H-65030	Hydraulic Oil Filter.....	HC-57020	TS-32 (SCRAPERS) DETROIT 8V-71T REAR ENGINE	
S-18 30LOT (SCRAPERS)		TFC 45H (FORKLIFTS) 2007-UP		Hydraulic Oil Filter Transmission...	H-65030
Hydraulic Oil Filter Transmission...	H-65030	Hydraulic Oil Filter.....	H-5001	TS-36 (SCRAPERS) DETROIT 12V-71N FRONT ENGINE	
S-23E (SCRAPERS) DETROIT 8V-71T		TR100 (DUMP TRUCKS) CUMMINS		Hydraulic Oil Filter Transmission...	H-65030
Hydraulic Oil Filter Transmission...	H-65030	Hydraulic Oil Filter.....	H-57030	TS40 (SCRAPERS) DETROIT 8V-71N FRONT ENGINE	
S-24 (SCRAPERS) DETROIT DIESEL		TR100 (DUMP TRUCKS) DETROIT DIESEL		Hydraulic Oil Filter Transmission...	H-65030
Hydraulic Oil Filter Transmission...	H-65030	Hydraulic Oil Filter.....	H-57030	TS40 (SCRAPERS) DETROIT 8V-71N REAR ENGINE	
S28 (SCRAPERS) DETROIT DIESEL		TR45 (DUMP TRUCKS) CUMMINS		Hydraulic Oil Filter Transmission...	H-65030
Hydraulic Oil Filter Transmission...	H-65030	Hydraulic Oil Filter.....	H-57030	TS50 (SCRAPERS) DETROIT 8V-71T REAR ENGINE	
S-35E (SCRAPERS) DETROIT 12V-71T		TR45 (DUMP TRUCKS) CUMMINS QSK19 (TIER 3)		Hydraulic Oil Filter Transmission...	H-65030
Hydraulic Oil Filter Transmission...	H-65030	Hydraulic Oil Filter.....	H-57030	THOMAS EQUIPMENT LTD	
S7 (SCRAPERS) DETROIT 4-71		TR60 (DUMP TRUCKS) CUMMINS QSK19		T03 (SKIDDERS) 1995-UP	
Hydraulic Oil Filter Transmission...	H-65030	Hydraulic Oil Filter.....	H-57030	Hydraulic Oil Filter.....	HC-5508
TA25 (DUMPERS) CUMMINS , 2004-UP		TR70 (DUMP TRUCKS) DETROIT DETROIT , 2004-UP		THWAITES	
Hydraulic Oil Filter Transmission...	HC-76130	Hydraulic Oil Filter.....	H-57030	7010 (CONSTRUCTION & MINING) PERKINS 1000.4	
TA27 (DUMPERS) CUMMINS , 2004-UP		TS14 (SCRAPERS) DETROIT (QTY 2) DIESEL		Hydraulic Oil Filter.....	HC-7905
Hydraulic Oil Filter Transmission...	HC-76130	Hydraulic Oil Filter Transmission...	H-65030	TIMBERJACK	
TA35 (DUMPERS)		TS14 (SCRAPERS) LEYLAND 600 (QTY 2)		1110 (FOREST EQUIPMENTS)	
Hydraulic Oil Filter Transmission...	HC-76130	Hydraulic Oil Filter Transmission...	H-65030	Hydraulic Oil Filter.....	HC-5507
TA-30 (DUMPERS) CUMMINS MTA11 , 2000-UP		TS-18 (SCRAPERS) DETROIT 6V-71N REAR ENGINE		1110C (FOREST EQUIPMENTS) PERKINS 1006-60T , 2001-UP	
Hydraulic Oil Filter Transmission...	HC-76130	Hydraulic Oil Filter Transmission...	H-65030	Hydraulic Oil Filter.....	H-7602
TA40 (DUMPERS) 2004-UP		TS-24 (SCRAPERS) CUMMINS NTC-310 (QTY 2)		1110C (CONSTRUCTION & MINING) PERKINS 1006-60T , 2001	
Hydraulic Oil Filter Transmission...	HC-76130	Hydraulic Oil Filter Transmission...	H-65030	Hydraulic Oil Filter.....	H-7602



ENGINE APPLICATION

MODEL/APPLICATION	SAKURA NO	MODEL/APPLICATION	SAKURA NO	MODEL/APPLICATION	SAKURA NO
TIMBERJACK		TOWMOTOR		TOYOTA	
1270A (FOREST EQUIPMENTS)		Hydraulic Oil Filter.....	H-79411	02-2FD15 (FORKLIFTS) TOYOTA 2J DIESEL	
Hydraulic Oil Filter.....	HC-6801	600S (FORKLIFTS) S/N: 6005640044-UP		Hydraulic Oil Filter.....	H-5902
Hydraulic Oil Filter.....	H-7922	Hydraulic Oil Filter.....	H-79411	02-2FD20 (FORKLIFTS) TOYOTA 2J DIESEL	
1270B (FOREST EQUIPMENTS)		670S (FORKLIFTS)		Hydraulic Oil Filter.....	H-5902
Hydraulic Oil Filter.....	HC-5507	Hydraulic Oil Filter.....	H-79411	02-2FD25 (FORKLIFTS) TOYOTA 2J DIESEL	
2515 (LOGGERS) JDEERE		680P (FORKLIFTS)		Hydraulic Oil Filter.....	H-5902
Hydraulic Oil Filter.....	H-85110	Hydraulic Oil Filter.....	H-79411	02-2FD30 (FORKLIFTS) TOYOTA 2J DIESEL	
2628 (LOGGERS) JDEERE		B10 (FORKLIFTS)		Hydraulic Oil Filter.....	H-5902
Hydraulic Oil Filter.....	H-85110	Hydraulic Oil Filter.....	H-79411	02-2FDC20 (FORKLIFTS) TOYOTA 2J DIESEL 1 -8001	
460 (FOREST EQUIPMENTS) CUMMINS 6BTA5.9		T100C (FORKLIFTS)		Hydraulic Oil Filter.....	H-5902
Hydraulic Oil Filter.....	HC-5506	Hydraulic Oil Filter.....	HC-5511	02-2FDC20 (FORKLIFTS) TOYOTA 2J DIESEL 8002 -8203	
Hydraulic Oil Filter.....	HC-7927	T30 (FORKLIFTS) PERKINS D3.152		Hydraulic Oil Filter.....	H-5902
550 NATURAL (LOGGERS) GMC GM DIESEL		Hydraulic Oil Filter.....	H-79411	02-2FDC20 (FORKLIFTS) TOYOTA 2J DIESEL 8204 -8304	
Hydraulic Oil Filter Transmission...	H-65030	Hydraulic Oil Filter.....	HC-5511	Hydraulic Oil Filter.....	H-5902
TORO		T60 (FORKLIFTS) CONTINEL CONTINENTAL		02-2FDC20 (FORKLIFTS) TOYOTA 2J DIESEL 8305	
GREENSMASER 3 (LAWN EQUIPMENT)		Hydraulic Oil Filter.....	H-79411	Hydraulic Oil Filter.....	H-5902
Hydraulic Oil Filter.....	HC-5511	Hydraulic Oil Filter.....	HC-5501	02-2FDC20 (FORKLIFTS) TOYOTA 2J DIESEL (S/N: 1-8001)	
Hydraulic Oil Filter.....	HC-1903	T60 (FORKLIFTS) PERKINS		Hydraulic Oil Filter.....	H-5902
GROUNDMASTER 223D (LAWN EQUIPMENT)		Hydraulic Oil Filter.....	H-79411	02-2FDC20 (FORKLIFTS) TOYOTA 2J DIESEL (S/N: 8002-8203)	
Hydraulic Oil Filter.....	HC-1903	Hydraulic Oil Filter.....	HC-5501	Hydraulic Oil Filter.....	H-5902
REELMASTER 223 (LAWN EQUIPMENT)		V30 (FORKLIFTS)		02-2FDC20 (FORKLIFTS) TOYOTA 2J DIESEL (S/N: 8204-8304)	
Hydraulic Oil Filter.....	HC-57030	Hydraulic Oil Filter.....	H-79411	Hydraulic Oil Filter.....	H-5902
Hydraulic Oil Filter.....	HC-76100	V30B (FORKLIFTS)		02-2FDC20 (FORKLIFTS) TOYOTA 2J DIESEL (S/N: 8305-UP)	
SANDPRO (LAWN EQUIPMENT)		Hydraulic Oil Filter.....	H-79411	Hydraulic Oil Filter.....	H-5902
Hydraulic Oil Filter.....	HC-1903	V30C (FORKLIFTS)		02-2FDC25 (FORKLIFTS) TOYOTA 2J DIESEL 1 -8001	
TURF PRO (LAWN EQUIPMENT)		Hydraulic Oil Filter.....	H-79411	Hydraulic Oil Filter.....	H-5902
Hydraulic Oil Filter.....	HC-1903	V41 (FORKLIFTS)		02-2FDC25 (FORKLIFTS) TOYOTA 2J DIESEL 8002 -8203	
TOWMOTOR		Hydraulic Oil Filter.....	H-79411	Hydraulic Oil Filter.....	H-5902
422S (FORKLIFTS)		V60C (FORKLIFTS)		02-2FDC25 (FORKLIFTS) TOYOTA 2J DIESEL 8204 -8304	
Hydraulic Oil Filter.....	H-79411	Hydraulic Oil Filter.....	H-5506	Hydraulic Oil Filter.....	H-5902
Hydraulic Oil Filter.....	HC-5511	TOYOTA		02-2FDC25 (FORKLIFTS) TOYOTA 2J DIESEL 8305	
502S (FORKLIFTS)		02-2FD10 (FORKLIFTS) TOYOTA 2J DIESEL		Hydraulic Oil Filter.....	H-5902
Hydraulic Oil Filter.....	H-79411	Hydraulic Oil Filter.....	H-5902	02-2FDC25 (FORKLIFTS) TOYOTA 2J DIESEL 8305	
540S (FORKLIFTS) PERKINS 4.27		02-2FD14 (FORKLIFTS) TOYOTA 2J DIESEL		Hydraulic Oil Filter.....	H-5902
Hydraulic Oil Filter.....	H-79411	Hydraulic Oil Filter.....	H-5902	02-2FG20 (FORKLIFTS) TOYOTA 4P GAS	
600S (FORKLIFTS) S/N: 1-6005640043				Hydraulic Oil Filter.....	H-5902



ENGINE APPLICATION

MODEL/APPLICATION	SAKURA NO	MODEL/APPLICATION	SAKURA NO	MODEL/APPLICATION	SAKURA NO
TOYOTA		TOYOTA		TOYOTA	
02-2FG25 (<i>FORKLIFTS</i>) TOYOTA 4P GAS		02-2FG 35/40 (<i>FORKLIFTS</i>) 2000		02-3FD35 (<i>FORKLIFTS</i>) TOYOTA 2H DIESEL 1 -8003	
Hydraulic Oil Filter.....	H-5902	Hydraulic Oil Filter.....	H-5902	Hydraulic Oil Filter.....	H-5902
02-2FG32 (<i>FORKLIFTS</i>) TOYOTA 2F GAS		02-3FD10-18 (<i>FORKLIFTS</i>) TOYOTA 2J DIESEL 1 -7803		02-3FD35 (<i>FORKLIFTS</i>) TOYOTA 2H DIESEL 8004 -8008	
Hydraulic Oil Filter.....	H-5902	Hydraulic Oil Filter.....	H-5902	Hydraulic Oil Filter.....	H-5902
02-2FG35 (<i>FORKLIFTS</i>) TOYOTA 2F GAS		02-3FD10-18 (<i>FORKLIFTS</i>) TOYOTA 2J DIESEL 7804 -7809		02-3FD35 (<i>FORKLIFTS</i>) TOYOTA 2H DIESEL 8009	
Hydraulic Oil Filter.....	H-5902	Hydraulic Oil Filter.....	H-5902	Hydraulic Oil Filter.....	H-5902
02-2FG40 (<i>FORKLIFTS</i>) TOYOTA 2F GAS		02-3FD10-18 (<i>FORKLIFTS</i>) TOYOTA 2J DIESEL 7810 -8203		02-3FD35 (<i>FORKLIFTS</i>) TOYOTA 2H DIESEL 8305	
Hydraulic Oil Filter.....	H-5902	Hydraulic Oil Filter.....	H-5902	Hydraulic Oil Filter.....	H-5902
02-2FGC30 (<i>FORKLIFTS</i>) TOYOTA 5P GAS		02-3FD10-18 (<i>FORKLIFTS</i>) TOYOTA 2J DIESEL 8204		02-3FD40 (<i>FORKLIFTS</i>) TOYOTA 2H DIESEL 1 -8003	
Hydraulic Oil Filter.....	H-5902	Hydraulic Oil Filter.....	H-5902	Hydraulic Oil Filter.....	H-5902
02-2FGCH10 (<i>FORKLIFTS</i>) TOYOTA 4P GAS		02-3FD10-18 (<i>FORKLIFTS</i>) TOYOTA 2J DIESEL (S/N: 1-7803)		02-3FD40 (<i>FORKLIFTS</i>) TOYOTA 2H DIESEL 8004 -8008	
Hydraulic Oil Filter.....	H-5902	Hydraulic Oil Filter.....	H-5902	Hydraulic Oil Filter.....	H-5902
02-2FGCH15 (<i>FORKLIFTS</i>) TOYOTA 4P GAS		02-3FD10-18 (<i>FORKLIFTS</i>) TOYOTA 2J DIESEL (S/N: 7804-7809)		02-3FD40 (<i>FORKLIFTS</i>) TOYOTA 2H DIESEL 8009	
Hydraulic Oil Filter.....	H-5902	Hydraulic Oil Filter.....	H-5902	Hydraulic Oil Filter.....	H-5902
02-2FGE30 (<i>FORKLIFTS</i>) TOYOTA 2F GAS		02-3FD10-18 (<i>FORKLIFTS</i>) TOYOTA 2J DIESEL (S/N: 7810-8203)		02-3FD40 (<i>FORKLIFTS</i>) TOYOTA 2H DIESEL 8305	
Hydraulic Oil Filter.....	H-5902	Hydraulic Oil Filter.....	H-5902	Hydraulic Oil Filter.....	H-5902
02-2FD 10/15 (<i>FORKLIFTS</i>) 2000-UP		02-3FD10-18 (<i>FORKLIFTS</i>) TOYOTA 2J DIESEL (S/N: 8204-UP)		02-3FDE35 (<i>FORKLIFTS</i>) TOYOTA 2H DIESEL 1 -8003	
Hydraulic Oil Filter.....	H-5902	Hydraulic Oil Filter.....	H-5902	Hydraulic Oil Filter.....	H-5902
02-2FD 10/15 (<i>FORKLIFTS</i>) 2000		02-3FD33 (<i>FORKLIFTS</i>) TOYOTA 2H DIESEL 1 -8003		02-3FDE35 (<i>FORKLIFTS</i>) TOYOTA 2H DIESEL 8004 -8008	
Hydraulic Oil Filter.....	H-5902	Hydraulic Oil Filter.....	H-5902	Hydraulic Oil Filter.....	H-5902
02-2FD 20/25/30 (<i>FORKLIFTS</i>) 2000-UP		02-3FD33 (<i>FORKLIFTS</i>) TOYOTA 2H DIESEL 8004 -8008		02-3FDE35 (<i>FORKLIFTS</i>) TOYOTA 2H DIESEL 8009 -8304	
Hydraulic Oil Filter.....	H-5902	Hydraulic Oil Filter.....	H-5902	Hydraulic Oil Filter.....	H-5902
02-2FD 20/25/30 (<i>FORKLIFTS</i>) 2000		02-3FD33 (<i>FORKLIFTS</i>) TOYOTA 2H DIESEL 8009		02-3FDE35 (<i>FORKLIFTS</i>) TOYOTA 2H DIESEL 8305	
Hydraulic Oil Filter.....	H-5902	Hydraulic Oil Filter.....	H-5902	Hydraulic Oil Filter.....	H-5902
02-2FD 35/40 (<i>FORKLIFTS</i>) 2000-UP		02-3FD33 (<i>FORKLIFTS</i>) TOYOTA 2H DIESEL 8305		02-3FDE35 (<i>FORKLIFTS</i>) TOYOTA 2H DIESEL (S/N: 1-8003)	
Hydraulic Oil Filter.....	H-5902	Hydraulic Oil Filter.....	H-5902	Hydraulic Oil Filter.....	H-5902
02-2FD 35/40 (<i>FORKLIFTS</i>) 2000		02-3FD33 (<i>FORKLIFTS</i>) TOYOTA 2H DIESEL (S/N: 1-8003)		02-3FDE35 (<i>FORKLIFTS</i>) TOYOTA 2H DIESEL (S/N: 8004-8008)	
Hydraulic Oil Filter.....	H-5902	Hydraulic Oil Filter.....	H-5902	Hydraulic Oil Filter.....	H-5902
02-2FG 28/30 (<i>FORKLIFTS</i>) 2000-UP		02-3FD33 (<i>FORKLIFTS</i>) TOYOTA 2H DIESEL (S/N: 8004-8008)		02-3FDE35 (<i>FORKLIFTS</i>) TOYOTA 2H DIESEL (S/N: 8009-8304)	
Hydraulic Oil Filter.....	H-5902	Hydraulic Oil Filter.....	H-5902	Hydraulic Oil Filter.....	H-5902
02-2FG 28/30 (<i>FORKLIFTS</i>) 2000		02-3FD33 (<i>FORKLIFTS</i>) TOYOTA 2H DIESEL (S/N: 8009-UP)		02-3FDE35 (<i>FORKLIFTS</i>) TOYOTA 2H DIESEL (S/N: 8305-UP)	
Hydraulic Oil Filter.....	H-5902	Hydraulic Oil Filter.....	H-5902	Hydraulic Oil Filter.....	H-5902
02-2FG 35/40 (<i>FORKLIFTS</i>) 2000-UP		02-3FD33 (<i>FORKLIFTS</i>) TOYOTA 2H DIESEL (S/N: 8305-UP)		02-3FG10 (<i>FORKLIFTS</i>) TOYOTA 4P GAS	
Hydraulic Oil Filter.....	H-5902	Hydraulic Oil Filter.....	H-5902	Hydraulic Oil Filter.....	H-5902



ENGINE APPLICATION

MODEL/APPLICATION	SAKURA NO	MODEL/APPLICATION	SAKURA NO	MODEL/APPLICATION	SAKURA NO
TOYOTA		TOYOTA		TOYOTA	
02-3FG14 (<i>FORKLIFTS</i>) TOYOTA 4P GAS		02-4FD20 (<i>FORKLIFTS</i>) TOYOTA 2J DIESEL (S/N: 8204-UP)		02-4FGL23 (<i>FORKLIFTS</i>) TOYOTA 4P	
Hydraulic Oil Filter.....	H-5902	Hydraulic Oil Filter.....	H-5902	Hydraulic Oil Filter.....	H-5902
02-3FG15 (<i>FORKLIFTS</i>) TOYOTA 4P GAS		02-4FD23 (<i>FORKLIFTS</i>) TOYOTA 2J DIESEL 1 -7803		02-4FGL25 (<i>FORKLIFTS</i>) TOYOTA 4P	
Hydraulic Oil Filter.....	H-5902	Hydraulic Oil Filter.....	H-5902	Hydraulic Oil Filter.....	H-5902
02-3FG20 (<i>FORKLIFTS</i>) TOYOTA 4P GAS		02-4FD23 (<i>FORKLIFTS</i>) TOYOTA 2J DIESEL 7804 -7809		02-5FG33 (<i>FORKLIFTS</i>)	
Hydraulic Oil Filter.....	H-5902	Hydraulic Oil Filter.....	H-5902	Hydraulic Oil Filter.....	H-5902
02-3FG25 (<i>FORKLIFTS</i>) TOYOTA 4P GAS		02-4FD23 (<i>FORKLIFTS</i>) TOYOTA 2J DIESEL 7810 -8203		02-5FG35 (<i>FORKLIFTS</i>)	
Hydraulic Oil Filter.....	H-5902	Hydraulic Oil Filter.....	H-5902	Hydraulic Oil Filter.....	H-5902
02-3FG33 (<i>FORKLIFTS</i>) TOYOTA 4P GAS		02-4FD23 (<i>FORKLIFTS</i>) TOYOTA 2J DIESEL 8204		02-62-7FDF30 (<i>FORKLIFTS</i>)	
Hydraulic Oil Filter.....	H-5902	Hydraulic Oil Filter.....	H-5902	Hydraulic Oil Filter Transmission....	HC-1119
02-3FG35 (<i>FORKLIFTS</i>) TOYOTA 4P GAS		02-4FD25 (<i>FORKLIFTS</i>) TOYOTA 2J DIESEL 1 -7803		Hydraulic Oil Filter Return.....	H-5901
Hydraulic Oil Filter.....	H-5902	Hydraulic Oil Filter.....	H-5902	Hydraulic Oil Filter Suction.....	H-8522
02-3FG40 (<i>FORKLIFTS</i>) TOYOTA 4P GAS		02-4FD25 (<i>FORKLIFTS</i>) TOYOTA 2J DIESEL 7804 -7809		02-62-7FDF30 (<i>FORKLIFTS</i>)	
Hydraulic Oil Filter.....	H-5902	Hydraulic Oil Filter.....	H-5902	Hydraulic Oil Filter Return.....	H-5901
02-3FGCH20 (<i>FORKLIFTS</i>) TOYOTA 4P GAS		02-4FD25 (<i>FORKLIFTS</i>) TOYOTA 2J DIESEL 7810 -8203		Hydraulic Oil Filter Suction.....	H-8522
Hydraulic Oil Filter.....	H-5902	Hydraulic Oil Filter.....	H-5902	02-FD18 (<i>FORKLIFTS</i>) TOYOTA 2J DIESEL 1 -7803	
02-3FGCH25 (<i>FORKLIFTS</i>) TOYOTA 4P GAS		02-4FD25 (<i>FORKLIFTS</i>) TOYOTA 2J DIESEL 8204		Hydraulic Oil Filter.....	H-5902
Hydraulic Oil Filter.....	H-5902	Hydraulic Oil Filter.....	H-5902	02-FD18 (<i>FORKLIFTS</i>) TOYOTA 2J DIESEL 7804 -7809	
02-3FGL20 (<i>FORKLIFTS</i>) TOYOTA 4P		02-4FG10 (<i>FORKLIFTS</i>) TOYOTA 4P GAS		Hydraulic Oil Filter.....	H-5902
Hydraulic Oil Filter.....	H-5902	Hydraulic Oil Filter.....	H-5902	02-FD18 (<i>FORKLIFTS</i>) TOYOTA 2J DIESEL 8204	
02-4FD20 (<i>FORKLIFTS</i>) TOYOTA 2J DIESEL 1 -7803		02-4FG14 (<i>FORKLIFTS</i>) TOYOTA 4P GAS		Hydraulic Oil Filter.....	H-5902
Hydraulic Oil Filter.....	H-5902	Hydraulic Oil Filter.....	H-5902	02-FD18 (<i>FORKLIFTS</i>) TOYOTA 2J DIESEL (S/N: 1-7803)	
02-4FD20 (<i>FORKLIFTS</i>) TOYOTA 2J DIESEL 7804 -7809		02-4FG15 (<i>FORKLIFTS</i>) TOYOTA 4P GAS		Hydraulic Oil Filter.....	H-5902
Hydraulic Oil Filter.....	H-5902	Hydraulic Oil Filter.....	H-5902	02-FD18 (<i>FORKLIFTS</i>) TOYOTA 2J DIESEL (S/N: 7804-7809)	
02-4FD20 (<i>FORKLIFTS</i>) TOYOTA 2J DIESEL 7810 -8203		02-4FG18 (<i>FORKLIFTS</i>) TOYOTA 4P GAS		Hydraulic Oil Filter.....	H-5902
Hydraulic Oil Filter.....	H-5902	Hydraulic Oil Filter.....	H-5902	02-FD18 (<i>FORKLIFTS</i>) TOYOTA 2J DIESEL (S/N: 7810-8203)	
02-4FD20 (<i>FORKLIFTS</i>) TOYOTA 2J DIESEL 8204		02-4FG20 (<i>FORKLIFTS</i>) TOYOTA 4P GAS		Hydraulic Oil Filter.....	H-5902
Hydraulic Oil Filter.....	H-5902	Hydraulic Oil Filter.....	H-5902	02-FD18 (<i>FORKLIFTS</i>) TOYOTA 2J DIESEL (S/N: 8204-UP)	
02-4FD20 (<i>FORKLIFTS</i>) TOYOTA 2J DIESEL (S/N: 1-7803)		02-4FG23 (<i>FORKLIFTS</i>) TOYOTA 4P GAS		Hydraulic Oil Filter.....	H-5902
Hydraulic Oil Filter.....	H-5902	Hydraulic Oil Filter.....	H-5902	02-FD23 (<i>FORKLIFTS</i>) TOYOTA 2J DIESEL 1 -7803	
02-4FD20 (<i>FORKLIFTS</i>) TOYOTA 2J DIESEL (S/N: 7804-7809)		02-4FG25 (<i>FORKLIFTS</i>) TOYOTA 4P GAS		Hydraulic Oil Filter.....	H-5902
Hydraulic Oil Filter.....	H-5902	Hydraulic Oil Filter.....	H-5902	02-FD23 (<i>FORKLIFTS</i>) TOYOTA 2J DIESEL 7804 -7809	
02-4FD20 (<i>FORKLIFTS</i>) TOYOTA 2J DIESEL (S/N: 7810-8203)		02-4FGL20 (<i>FORKLIFTS</i>) TOYOTA 4P		Hydraulic Oil Filter.....	H-5902
Hydraulic Oil Filter.....	H-5902	Hydraulic Oil Filter.....	H-5902		



ENGINE APPLICATION

MODEL/APPLICATION	SAKURA NO	MODEL/APPLICATION	SAKURA NO	MODEL/APPLICATION	SAKURA NO
TOYOTA		TOYOTA		TOYOTA	
02-FD23 (FORKLIFTS) TOYOTA 2J DIESEL 7810 -8203	H-5902	02-FDC23 (FORKLIFTS) TOYOTA 2J DIESEL 1 -8001	H-5902	2FBE10 (FORKLIFTS)	H-5902
Hydraulic Oil Filter.....		Hydraulic Oil Filter.....		Hydraulic Oil Filter.....	
02-FD23 (FORKLIFTS) TOYOTA 2J DIESEL 8204	H-5902	02-FDC23 (FORKLIFTS) TOYOTA 2J DIESEL 8002 -8203	H-5902	2FD10 (FORKLIFTS) TOYOTA 2P DIESEL	H-5902
Hydraulic Oil Filter.....		Hydraulic Oil Filter.....		Hydraulic Oil Filter.....	
02-FD23 (FORKLIFTS) TOYOTA 2J DIESEL (S/N: 1-7803)	H-5902	02-FDC23 (FORKLIFTS) TOYOTA 2J DIESEL 8204 -8304	H-5902	2FD14 (FORKLIFTS) TOYOTA 2P DIESEL	H-5902
Hydraulic Oil Filter.....		Hydraulic Oil Filter.....		Hydraulic Oil Filter.....	
02-FD23 (FORKLIFTS) TOYOTA 2J DIESEL (S/N: 7804-7809)	H-5902	02-FDC23 (FORKLIFTS) TOYOTA 4P GAS	H-5902	2FD15 (FORKLIFTS) TOYOTA 2P DIESEL	H-5902
Hydraulic Oil Filter.....		Hydraulic Oil Filter.....		Hydraulic Oil Filter.....	
02-FD23 (FORKLIFTS) TOYOTA 2J DIESEL (S/N: 7810-8203)	H-5902	02-FDC25 (FORKLIFTS) TOYOTA 2J DIESEL	H-5902	2FD32 (FORKLIFTS) TOYOTA 2P DIESEL	H-5902
Hydraulic Oil Filter.....		Hydraulic Oil Filter.....		Hydraulic Oil Filter.....	
02-FD23 (FORKLIFTS) TOYOTA 2J DIESEL (S/N: 8204-UP)	H-5902	02-FDC25 (FORKLIFTS) TOYOTA 2J DIESEL 8305	H-5902	2FD35 (FORKLIFTS) TOYOTA 2P DIESEL	H-5902
Hydraulic Oil Filter.....		Hydraulic Oil Filter.....		Hydraulic Oil Filter.....	
02-FDC15 (FORKLIFTS) TOYOTA 2J DIESEL	H-5902	02-FDC30 (FORKLIFTS) TOYOTA 2J DIESEL	H-5902	2FD40 (FORKLIFTS) TOYOTA 2P DIESEL	H-5902
Hydraulic Oil Filter.....		Hydraulic Oil Filter.....		Hydraulic Oil Filter.....	
02-FDC18 (FORKLIFTS) TOYOTA 2J DIESEL 1 -8001	H-5902	02-FG18 (FORKLIFTS) TOYOTA 4P GAS	H-5902	2FDC20 (FORKLIFTS) TOYOTA 2P DIESEL 1 -8001	H-5902
Hydraulic Oil Filter.....		Hydraulic Oil Filter.....		Hydraulic Oil Filter.....	
02-FDC18 (FORKLIFTS) TOYOTA 2J DIESEL 8002 -8203	H-5902	02-FG23 (FORKLIFTS) TOYOTA 4P GAS	H-5902	2FDC20 (FORKLIFTS) TOYOTA 2P DIESEL 8002 -8203	H-5902
Hydraulic Oil Filter.....		Hydraulic Oil Filter.....		Hydraulic Oil Filter.....	
02-FDC18 (FORKLIFTS) TOYOTA 2J DIESEL 8204 -8304	H-5902	02-FG30 (FORKLIFTS) TOYOTA 4P GAS	H-5902	2FDC20 (FORKLIFTS) TOYOTA 2P DIESEL 8204 -8304	H-5902
Hydraulic Oil Filter.....		Hydraulic Oil Filter.....		Hydraulic Oil Filter.....	
02-FDC18 (FORKLIFTS) TOYOTA 4P GAS	H-5902	02-FGC20 (FORKLIFTS) TOYOTA 4P GAS	H-5902	2FDC20 (FORKLIFTS) TOYOTA 2P DIESEL 8305	H-5902
Hydraulic Oil Filter.....		Hydraulic Oil Filter.....		Hydraulic Oil Filter.....	
02-FDC18 (FORKLIFTS) TOYOTA 2J DIESEL (S/N: 1-8001)	H-5902	02-FGC25 (FORKLIFTS) TOYOTA 4P GAS	H-5902	2FDC20 (FORKLIFTS) TOYOTA 2P DIESEL (S/N: 1-8001)	H-5902
Hydraulic Oil Filter.....		Hydraulic Oil Filter.....		Hydraulic Oil Filter.....	
02-FDC18 (FORKLIFTS) TOYOTA 2J DIESEL (S/N: 8002-8203)	H-5902	02-FGC30 (FORKLIFTS) TOYOTA 5R GAS	H-5902	2FDC20 (FORKLIFTS) TOYOTA 2P DIESEL (S/N: 8002-8203)	H-5902
Hydraulic Oil Filter.....		Hydraulic Oil Filter.....		Hydraulic Oil Filter.....	
02-FDC18 (FORKLIFTS) TOYOTA 2J DIESEL (S/N: 8204-8304)	H-5902	02-FGE35 (FORKLIFTS) TOYOTA 4P GAS	H-5902	2FDC20 (FORKLIFTS) TOYOTA 2P DIESEL (S/N: 8204-8304)	H-5902
Hydraulic Oil Filter.....		Hydraulic Oil Filter.....		Hydraulic Oil Filter.....	
02-FDC20 (FORKLIFTS) TOYOTA 2J DIESEL	H-5902	02-FGL18 (FORKLIFTS) TOYOTA 4P	H-5902	2FDC20 (FORKLIFTS) TOYOTA 2P DIESEL (S/N: 8305-UP)	H-5902
Hydraulic Oil Filter.....		Hydraulic Oil Filter.....		Hydraulic Oil Filter.....	
02-FDC20 (FORKLIFTS) TOYOTA 2J DIESEL 8305	H-5902	02-FGL23 (FORKLIFTS) TOYOTA 4P	H-5902	2FDC25 (FORKLIFTS)	H-5902
Hydraulic Oil Filter.....		Hydraulic Oil Filter.....		Hydraulic Oil Filter.....	
02-FDC20 (FORKLIFTS) TOYOTA 2J DIESEL (S/N: 8305-UP)	H-5902	2FBCA20 ELECTRIC (FORKLIFTS)	H-5902	2FDC25 (FORKLIFTS) TOYOTA 2P DIESEL 1 -8001	H-5902
Hydraulic Oil Filter.....		Hydraulic Oil Filter.....		Hydraulic Oil Filter.....	



ENGINE APPLICATION

MODEL/APPLICATION	SAKURA NO	MODEL/APPLICATION	SAKURA NO	MODEL/APPLICATION	SAKURA NO
TOYOTA		TOYOTA		TOYOTA	
2FDC25 (<i>FORKLIFTS</i>) TOYOTA 2P DIESEL 8002 -8203		2FG28 (<i>FORKLIFTS</i>) TOYOTA 2J (S/N: 7811-8205)		2FG32 (<i>FORKLIFTS</i>) TOYOTA 2F GAS	
Hydraulic Oil Filter.....	H-5902	Hydraulic Oil Filter.....	H-5902	Hydraulic Oil Filter.....	H-5902
2FDC25 (<i>FORKLIFTS</i>) TOYOTA 2P DIESEL 8204 -8304		2FG28 (<i>FORKLIFTS</i>) TOYOTA 2J (S/N: 8407-8407)		2FG35 (<i>FORKLIFTS</i>) TOYOTA 2F GAS	
Hydraulic Oil Filter.....	H-5902	Hydraulic Oil Filter.....	H-5902	Hydraulic Oil Filter.....	H-5902
2FDC25 (<i>FORKLIFTS</i>) TOYOTA 2P DIESEL 8305		2FG28 (<i>FORKLIFTS</i>) TOYOTA 2J (S/N: 8408-8608)		2FG40 (<i>FORKLIFTS</i>) TOYOTA 2F GAS	
Hydraulic Oil Filter.....	H-5902	Hydraulic Oil Filter.....	H-5902	Hydraulic Oil Filter.....	H-5902
2FDA30 (<i>FORKLIFTS</i>) S/N: 8105-8305		2FG28 (<i>FORKLIFTS</i>) TOYOTA 2J (S/N: 8606-8608)		2FG7 (<i>FORKLIFTS</i>) TOYOTA 4P GAS 8107	
Hydraulic Oil Filter.....	H-5902	Hydraulic Oil Filter.....	H-5902	Hydraulic Oil Filter.....	H-5902
2FDA30 (<i>FORKLIFTS</i>) S/N: 8306-8904		2FG28 (<i>FORKLIFTS</i>) TOYOTA 4P (S/N: 7804-8009)		2FG7 (<i>FORKLIFTS</i>) TOYOTA 4P GAS (S/N: 8107-UP)	
Hydraulic Oil Filter.....	H-5902	Hydraulic Oil Filter.....	H-5902	Hydraulic Oil Filter.....	H-5902
2FDC30 (<i>FORKLIFTS</i>) S/N: 8002-8803		2FG28 (<i>FORKLIFTS</i>) TOYOTA 5P (S/N: 7804-8009)		2FG9 (<i>FORKLIFTS</i>) TOYOTA 4P GAS 8107	
Hydraulic Oil Filter.....	H-5902	Hydraulic Oil Filter.....	H-5902	Hydraulic Oil Filter.....	H-5902
2FG20 (<i>FORKLIFTS</i>) TOYOTA 4P GAS		2FG28 (<i>FORKLIFTS</i>) TOYOTA 5P (S/N: 8407-8608)		2FGC30 (<i>FORKLIFTS</i>) TOYOTA 5P GAS	
Hydraulic Oil Filter.....	H-5902	Hydraulic Oil Filter.....	H-5902	Hydraulic Oil Filter.....	H-5902
2FG25 (<i>FORKLIFTS</i>) TOYOTA 4P GAS		2FG28 (<i>FORKLIFTS</i>) TOYOTA 5R (S/N: 7804-8009)		2FGCH10 (<i>FORKLIFTS</i>) TOYOTA 4P GAS	
Hydraulic Oil Filter.....	H-5902	Hydraulic Oil Filter.....	H-5902	Hydraulic Oil Filter.....	H-5902
2FG28 (<i>FORKLIFTS</i>) TOYOTA 2J 7811 -8205		2FG30 (<i>FORKLIFTS</i>) TOYOTA 2J 7811 -8205		2FGCH15 (<i>FORKLIFTS</i>) TOYOTA 4P GAS	
Hydraulic Oil Filter.....	H-5902	Hydraulic Oil Filter.....	H-5902	Hydraulic Oil Filter.....	H-5902
2FG28 (<i>FORKLIFTS</i>) TOYOTA 2J 8407		2FG30 (<i>FORKLIFTS</i>) TOYOTA 2J 8407		2SD10 (<i>FORKLIFTS</i>) TOYOTA 4P GAS 7405 -8102	
Hydraulic Oil Filter.....	H-5902	Hydraulic Oil Filter.....	H-5902	Hydraulic Oil Filter.....	H-5902
2FG28 (<i>FORKLIFTS</i>) TOYOTA 2J 8408 -8608		2FG30 (<i>FORKLIFTS</i>) TOYOTA 2J 8408 -8608		2SD10 (<i>FORKLIFTS</i>) TOYOTA 4P GAS 8103 -8207	
Hydraulic Oil Filter.....	H-5902	Hydraulic Oil Filter.....	H-5902	Hydraulic Oil Filter.....	H-5902
2FG28 (<i>FORKLIFTS</i>) TOYOTA 2JT 8606 -8608		2FG30 (<i>FORKLIFTS</i>) TOYOTA 2JT 8606 -8608		2SD10 (<i>FORKLIFTS</i>) TOYOTA 5R GAS 7405 -8102	
Hydraulic Oil Filter.....	H-5902	Hydraulic Oil Filter.....	H-5902	Hydraulic Oil Filter.....	H-5902
2FG28 (<i>FORKLIFTS</i>) TOYOTA 4P 7804 -8009		2FG30 (<i>FORKLIFTS</i>) TOYOTA 4P 7804 -8009		2SD10 (<i>FORKLIFTS</i>) TOYOTA 5R GAS 8103 -8207	
Hydraulic Oil Filter.....	H-5902	Hydraulic Oil Filter.....	H-5902	Hydraulic Oil Filter.....	H-5902
2FG28 (<i>FORKLIFTS</i>) TOYOTA 5P 7804 -8009		2FG30 (<i>FORKLIFTS</i>) TOYOTA 5P 7804 -8009		2SD10 (<i>FORKLIFTS</i>) TOYOTA 4P GAS (S/N: 7405-8102)	
Hydraulic Oil Filter.....	H-5902	Hydraulic Oil Filter.....	H-5902	Hydraulic Oil Filter.....	H-5902
2FG28 (<i>FORKLIFTS</i>) TOYOTA 5P 8407 -8608		2FG30 (<i>FORKLIFTS</i>) TOYOTA 5P 8407 -8608		2SD10 (<i>FORKLIFTS</i>) TOYOTA 4P GAS (S/N: 8103-8207)	
Hydraulic Oil Filter.....	H-5902	Hydraulic Oil Filter.....	H-5902	Hydraulic Oil Filter.....	H-5902
2FG28 (<i>FORKLIFTS</i>) TOYOTA 5P GAS		2FG30 (<i>FORKLIFTS</i>) TOYOTA 5P GAS		2SD10 (<i>FORKLIFTS</i>) TOYOTA 5R GAS (S/N: 7405-8102)	
Hydraulic Oil Filter.....	H-5902	Hydraulic Oil Filter.....	H-5902	Hydraulic Oil Filter.....	H-5902
2FG28 (<i>FORKLIFTS</i>) TOYOTA 5R 7804 -8009		2FG30 (<i>FORKLIFTS</i>) TOYOTA 5R 7804 -8009		2SD10 (<i>FORKLIFTS</i>) TOYOTA 5R GAS (S/N: 8103-8207)	
Hydraulic Oil Filter.....	H-5902	Hydraulic Oil Filter.....	H-5902	Hydraulic Oil Filter.....	H-5902



ENGINE APPLICATION

MODEL/APPLICATION	SAKURA NO	MODEL/APPLICATION	SAKURA NO	MODEL/APPLICATION	SAKURA NO
TOYOTA					
2SD12 (<i>FORKLIFTS</i>) TOYOTA 4P GAS 7405 -8102	H-5902	30-5FG10 (<i>FORKLIFTS</i>) TOYOTA 4P GAS	H-5902	3FD14 (<i>FORKLIFTS</i>) TOYOTA 2J DIESEL 8204 -8608	H-5902
Hydraulic Oil Filter.....		Hydraulic Oil Filter.....		Hydraulic Oil Filter.....	
2SD12 (<i>FORKLIFTS</i>) TOYOTA 4P GAS 8103 -8207	H-5902	30-5FG13 (<i>FORKLIFTS</i>) TOYOTA 4P GAS	H-5902	3FD14 (<i>FORKLIFTS</i>) TOYOTA 2J DIESEL 8609	H-5902
Hydraulic Oil Filter.....		Hydraulic Oil Filter.....		Hydraulic Oil Filter.....	
2SD12 (<i>FORKLIFTS</i>) TOYOTA 5R GAS 7405 -8102	H-5902	30-5FG15 (<i>FORKLIFTS</i>) TOYOTA 4P GAS	H-5902	3FD15 (<i>FORKLIFTS</i>) TOYOTA 2J DIESEL 7803	H-5902
Hydraulic Oil Filter.....		Hydraulic Oil Filter.....		Hydraulic Oil Filter.....	
2SD12 (<i>FORKLIFTS</i>) TOYOTA 5R GAS 8103 -8207	H-5902	3FD10 (<i>FORKLIFTS</i>) S/N: 8507-8608	H-5902	3FD15 (<i>FORKLIFTS</i>) TOYOTA 2J DIESEL 7804 -7809	H-5902
Hydraulic Oil Filter.....		Hydraulic Oil Filter.....		Hydraulic Oil Filter.....	
2SD7 (<i>FORKLIFTS</i>) TOYOTA 4P GAS 7507 -8207	H-5902	3FD10 (<i>FORKLIFTS</i>) TOYOTA 2J DIESEL 7803	H-5902	3FD15 (<i>FORKLIFTS</i>) TOYOTA 2J DIESEL 7810 -8203	H-5902
Hydraulic Oil Filter.....		Hydraulic Oil Filter.....		Hydraulic Oil Filter.....	
2SD7 (<i>FORKLIFTS</i>) TOYOTA 4P GAS 8208	H-5902	3FD10 (<i>FORKLIFTS</i>) TOYOTA 2J DIESEL 7804 -7809	H-5902	3FD15 (<i>FORKLIFTS</i>) TOYOTA 2J DIESEL 8204 -8608	H-5902
Hydraulic Oil Filter.....		Hydraulic Oil Filter.....		Hydraulic Oil Filter.....	
2SD7 (<i>FORKLIFTS</i>) TOYOTA 4P GAS (S/N: 7507-8207)	H-5902	3FD10 (<i>FORKLIFTS</i>) TOYOTA 2J DIESEL 7810 -8203	H-5902	3FD15 (<i>FORKLIFTS</i>) TOYOTA 2J DIESEL 8609	H-5902
Hydraulic Oil Filter.....		Hydraulic Oil Filter.....		Hydraulic Oil Filter.....	
2SD7 (<i>FORKLIFTS</i>) TOYOTA 4P GAS (S/N: 8208-UP)	H-5902	3FD10 (<i>FORKLIFTS</i>) TOYOTA 2J DIESEL 8204 -8608	H-5902	3FD18 (<i>FORKLIFTS</i>) TOYOTA 2J DIESEL 7803	H-5902
Hydraulic Oil Filter.....		Hydraulic Oil Filter.....		Hydraulic Oil Filter.....	
2SD20 (<i>FORKLIFTS</i>)	H-5902	3FD10 (<i>FORKLIFTS</i>) TOYOTA 2J DIESEL 8609	H-5902	3FD18 (<i>FORKLIFTS</i>) TOYOTA 2J DIESEL 7804 -7809	H-5902
Hydraulic Oil Filter.....		Hydraulic Oil Filter.....		Hydraulic Oil Filter.....	
2SG10 (<i>FORKLIFTS</i>) TOYOTA 4P GAS 7405 -8102	H-5902	3FD10 (<i>FORKLIFTS</i>) TOYOTA 2J DIESEL (S/N: 7804-7809)	H-5902	3FD18 (<i>FORKLIFTS</i>) TOYOTA 2J DIESEL 7810 -8203	H-5902
Hydraulic Oil Filter.....		Hydraulic Oil Filter.....		Hydraulic Oil Filter.....	
2SG10 (<i>FORKLIFTS</i>) TOYOTA 4P GAS 8103 -8207	H-5902	3FD10 (<i>FORKLIFTS</i>) TOYOTA 2J DIESEL (S/N: 7810-8203)	H-5902	3FD18 (<i>FORKLIFTS</i>) TOYOTA 2J DIESEL 8204 -8608	H-5902
Hydraulic Oil Filter.....		Hydraulic Oil Filter.....		Hydraulic Oil Filter.....	
2SG10 (<i>FORKLIFTS</i>) TOYOTA 4P GAS (S/N: 7405-8102)	H-5902	3FD10 (<i>FORKLIFTS</i>) TOYOTA 2J DIESEL (S/N: 8204-8608)	H-5902	3FD18 (<i>FORKLIFTS</i>) TOYOTA 2J DIESEL 8609	H-5902
Hydraulic Oil Filter.....		Hydraulic Oil Filter.....		Hydraulic Oil Filter.....	
2SG10 (<i>FORKLIFTS</i>) TOYOTA 4P GAS (S/N: 8103-8207)	H-5902	3FD10 (<i>FORKLIFTS</i>) TOYOTA 2J DIESEL (S/N: 8609-UP)	H-5902	3FD20 (<i>FORKLIFTS</i>) TOYOTA 2J DIESEL 7803	H-5902
Hydraulic Oil Filter.....		Hydraulic Oil Filter.....		Hydraulic Oil Filter.....	
2SG12 (<i>FORKLIFTS</i>) TOYOTA 4P GAS 7405 -8102	H-5902	3FD10 (<i>FORKLIFTS</i>) TOYOTA 2J DIESEL (S/N: TO-7803)	H-5902	3FD20 (<i>FORKLIFTS</i>) TOYOTA 2J DIESEL 7804 -7809	H-5902
Hydraulic Oil Filter.....		Hydraulic Oil Filter.....		Hydraulic Oil Filter.....	
2SG12 (<i>FORKLIFTS</i>) TOYOTA 4P GAS 8103 -8207	H-5902	3FD14 (<i>FORKLIFTS</i>) TOYOTA 2J DIESEL 7803	H-5902	3FD20 (<i>FORKLIFTS</i>) TOYOTA 2J DIESEL 7810 -8203	H-5902
Hydraulic Oil Filter.....		Hydraulic Oil Filter.....		Hydraulic Oil Filter.....	
2SG7 (<i>FORKLIFTS</i>) TOYOTA 4P GAS 7507 -8207	H-5902	3FD14 (<i>FORKLIFTS</i>) TOYOTA 2J DIESEL 7804 -7809	H-5902	3FD20 (<i>FORKLIFTS</i>) TOYOTA 2J DIESEL 8204 -8506	H-5902
Hydraulic Oil Filter.....		Hydraulic Oil Filter.....		Hydraulic Oil Filter.....	
2SG7 (<i>FORKLIFTS</i>) TOYOTA 4P GAS (S/N: 7507-8207)	H-5902	3FD14 (<i>FORKLIFTS</i>) TOYOTA 2J DIESEL 7810 -8203	H-5902	3FD20 (<i>FORKLIFTS</i>) TOYOTA 2J DIESEL 8507 -8608	H-5902
Hydraulic Oil Filter.....		Hydraulic Oil Filter.....		Hydraulic Oil Filter.....	



ENGINE APPLICATION

MODEL/APPLICATION	SAKURA NO	MODEL/APPLICATION	SAKURA NO	MODEL/APPLICATION	SAKURA NO
TOYOTA					
3FD20 (<i>FORKLIFTS</i>) TOYOTA 2J DIESEL 8609		3FD28 (<i>FORKLIFTS</i>) TOYOTA 2J DIESEL 7912 -8204		3FD33 (<i>FORKLIFTS</i>) TOYOTA 2H DIESEL 8009 -8304	
Hydraulic Oil Filter.....	H-5902	Hydraulic Oil Filter.....	H-5902	Hydraulic Oil Filter.....	H-5902
3FD20 (<i>FORKLIFTS</i>) TOYOTA 2J DIESEL (S/N: 7804-7809)		3FD28 (<i>FORKLIFTS</i>) TOYOTA 2J DIESEL 8205 -8506		3FD33 (<i>FORKLIFTS</i>) TOYOTA 2H DIESEL (S/N: 8004-8008)	
Hydraulic Oil Filter.....	H-5902	Hydraulic Oil Filter.....	H-5902	Hydraulic Oil Filter.....	H-5902
3FD20 (<i>FORKLIFTS</i>) TOYOTA 2J DIESEL (S/N: 7810-8203)		3FD28 (<i>FORKLIFTS</i>) TOYOTA 5P DIESEL -8608		3FD33 (<i>FORKLIFTS</i>) TOYOTA 2H DIESEL (S/N: 8009-8304)	
Hydraulic Oil Filter.....	H-5902	Hydraulic Oil Filter.....	H-5902	Hydraulic Oil Filter.....	H-5902
3FD20 (<i>FORKLIFTS</i>) TOYOTA 2J DIESEL (S/N: 8204-8506)		3FD28 (<i>FORKLIFTS</i>) TOYOTA 2J DIESEL (S/N: 1-7803)		3FD33 (<i>FORKLIFTS</i>) TOYOTA 2H DIESEL (S/N: T0-8003)	
Hydraulic Oil Filter.....	H-5902	Hydraulic Oil Filter.....	H-5902	Hydraulic Oil Filter.....	H-5902
3FD20 (<i>FORKLIFTS</i>) TOYOTA 2J DIESEL (S/N: 8507-8608)		3FD28 (<i>FORKLIFTS</i>) TOYOTA 2J DIESEL (S/N: 7804-7810)		3FD35 (<i>FORKLIFTS</i>) TOYOTA 2H DIESEL 8003	
Hydraulic Oil Filter.....	H-5902	Hydraulic Oil Filter.....	H-5902	Hydraulic Oil Filter.....	H-5902
3FD20 (<i>FORKLIFTS</i>) TOYOTA 2J DIESEL (S/N: 8609-UP)		3FD28 (<i>FORKLIFTS</i>) TOYOTA 2J DIESEL (S/N: 7810-7911)		3FD35 (<i>FORKLIFTS</i>) TOYOTA 2H DIESEL 8004 -8008	
Hydraulic Oil Filter.....	H-5902	Hydraulic Oil Filter.....	H-5902	Hydraulic Oil Filter.....	H-5902
3FD20 (<i>FORKLIFTS</i>) TOYOTA 2J DIESEL (S/N: T0-7803)		3FD28 (<i>FORKLIFTS</i>) TOYOTA 2J DIESEL (S/N: 7912-8204)		3FD35 (<i>FORKLIFTS</i>) TOYOTA 2H DIESEL 8009 -8304	
Hydraulic Oil Filter.....	H-5902	Hydraulic Oil Filter.....	H-5902	Hydraulic Oil Filter.....	H-5902
3FD25 (<i>FORKLIFTS</i>) TOYOTA 2J DIESEL 7803		3FD28 (<i>FORKLIFTS</i>) TOYOTA 2J DIESEL (S/N: 8205-8506)		3FD40 (<i>FORKLIFTS</i>) TOYOTA 2H DIESEL 8003	
Hydraulic Oil Filter.....	H-5902	Hydraulic Oil Filter.....	H-5902	Hydraulic Oil Filter.....	H-5902
3FD25 (<i>FORKLIFTS</i>) TOYOTA 2J DIESEL 7804 -7809		3FD28 (<i>FORKLIFTS</i>) TOYOTA 5P (S/N: 7804-8608)		3FD40 (<i>FORKLIFTS</i>) TOYOTA 2H DIESEL 8004 -8008	
Hydraulic Oil Filter.....	H-5902	Hydraulic Oil Filter.....	H-5902	Hydraulic Oil Filter.....	H-5902
3FD25 (<i>FORKLIFTS</i>) TOYOTA 2J DIESEL 7810 -8203		3FD30 (<i>FORKLIFTS</i>) TOYOTA 2J DIESEL 1 -7803		3FD40 (<i>FORKLIFTS</i>) TOYOTA 2H DIESEL 8009 -8304	
Hydraulic Oil Filter.....	H-5902	Hydraulic Oil Filter.....	H-5902	Hydraulic Oil Filter.....	H-5902
3FD25 (<i>FORKLIFTS</i>) TOYOTA 2J DIESEL 8204 -8506		3FD30 (<i>FORKLIFTS</i>) TOYOTA 2J DIESEL 7804 -7810		3FD50 (<i>FORKLIFTS</i>) TOYOTA 2D 7712 -7908	
Hydraulic Oil Filter.....	H-5902	Hydraulic Oil Filter.....	H-5902	Hydraulic Oil Filter.....	H-5902
3FD25 (<i>FORKLIFTS</i>) TOYOTA 2J DIESEL 8507 -8608		3FD30 (<i>FORKLIFTS</i>) TOYOTA 2J DIESEL 7810 -7911		3FD50 (<i>FORKLIFTS</i>) TOYOTA 2D 7909	
Hydraulic Oil Filter.....	H-5902	Hydraulic Oil Filter.....	H-5902	Hydraulic Oil Filter.....	H-5902
3FD25+D3282 (<i>FORKLIFTS</i>) TOYOTA 2J DIESEL 8609		3FD30 (<i>FORKLIFTS</i>) TOYOTA 2J DIESEL 7912 -8204		3FD50 (<i>FORKLIFTS</i>) TOYOTA 2F 7712 -7804	
Hydraulic Oil Filter.....	H-5902	Hydraulic Oil Filter.....	H-5902	Hydraulic Oil Filter.....	H-5902
3FD28 (<i>FORKLIFTS</i>) S/N: 7901-8608		3FD30 (<i>FORKLIFTS</i>) TOYOTA 2J DIESEL 8205 -8506		3FD50 (<i>FORKLIFTS</i>) TOYOTA 2F 7805	
Hydraulic Oil Filter.....	H-5902	Hydraulic Oil Filter.....	H-5902	Hydraulic Oil Filter.....	H-5902
3FD28 (<i>FORKLIFTS</i>) TOYOTA 2J DIESEL 1 -7803		3FD30 (<i>FORKLIFTS</i>) TOYOTA 5P 7804 -8608		3FD50 (<i>FORKLIFTS</i>) TOYOTA 2H 7712 -7911	
Hydraulic Oil Filter.....	H-5902	Hydraulic Oil Filter.....	H-5902	Hydraulic Oil Filter.....	H-5902
3FD28 (<i>FORKLIFTS</i>) TOYOTA 2J DIESEL 7804 -7810		3FD33 (<i>FORKLIFTS</i>) TOYOTA 2H DIESEL 8003		3FD50 (<i>FORKLIFTS</i>) TOYOTA 2H 7912 -8009	
Hydraulic Oil Filter.....	H-5902	Hydraulic Oil Filter.....	H-5902	Hydraulic Oil Filter.....	H-5902
3FD28 (<i>FORKLIFTS</i>) TOYOTA 2J DIESEL 7810 -7911		3FD33 (<i>FORKLIFTS</i>) TOYOTA 2H DIESEL 8004 -8008		3FD50 (<i>FORKLIFTS</i>) TOYOTA 2H 8001 -8009	
Hydraulic Oil Filter.....	H-5902	Hydraulic Oil Filter.....	H-5902	Hydraulic Oil Filter.....	H-5902



ENGINE APPLICATION

MODEL/APPLICATION	SAKURA NO	MODEL/APPLICATION	SAKURA NO	MODEL/APPLICATION	SAKURA NO
TOYOTA					
3FD50 (<i>FORKLIFTS</i>) TOYOTA 2H 8010 -8305	H-5902	3FD60 (<i>FORKLIFTS</i>) TOYOTA 2H 8001 -8009	H-5902	3FG33 (<i>FORKLIFTS</i>) TOYOTA 2F GAS 8004	H-5902
Hydraulic Oil Filter.....		Hydraulic Oil Filter.....		Hydraulic Oil Filter.....	
3FD50 (<i>FORKLIFTS</i>) TOYOTA 2H 8305	H-5902	3FD60 (<i>FORKLIFTS</i>) TOYOTA 2H 8010 -8305	H-5902	3FG33 (<i>FORKLIFTS</i>) TOYOTA 2F GAS 8101 -8806	H-5902
Hydraulic Oil Filter.....		Hydraulic Oil Filter.....		Hydraulic Oil Filter.....	
3FD50 (<i>FORKLIFTS</i>) TOYOTA 2D (S/N: 7712-7908)	H-5902	3FD60 (<i>FORKLIFTS</i>) TOYOTA 2H 8305	H-5902	3FG33 (<i>FORKLIFTS</i>) TOYOTA 2H 8004 -8008	H-5902
Hydraulic Oil Filter.....		Hydraulic Oil Filter.....		Hydraulic Oil Filter.....	
3FD50 (<i>FORKLIFTS</i>) TOYOTA 2D (S/N: 7909-UP)	H-5902	3FD80 (<i>FORKLIFTS</i>) S/N: 8210-UP	H-5902	3FG33 (<i>FORKLIFTS</i>) TOYOTA 2H 8306 -8806	H-5902
Hydraulic Oil Filter.....		Hydraulic Oil Filter.....		Hydraulic Oil Filter.....	
3FD50 (<i>FORKLIFTS</i>) TOYOTA 2F (S/N: 7712-7804)	H-5902	3FDE60 (<i>FORKLIFTS</i>) S/N: 8210-UP	H-5902	3FG33 (<i>FORKLIFTS</i>) TOYOTA 2F GAS (S/N: 8004-UP)	H-5902
Hydraulic Oil Filter.....		Hydraulic Oil Filter.....		Hydraulic Oil Filter.....	
3FD50 (<i>FORKLIFTS</i>) TOYOTA 2F (S/N: 7805-UP)	H-5902	3FG10 (<i>FORKLIFTS</i>) TOYOTA 4P GAS	H-5902	3FG33 (<i>FORKLIFTS</i>) TOYOTA 2F GAS (S/N: 8101-8806)	H-5902
Hydraulic Oil Filter.....		Hydraulic Oil Filter.....		Hydraulic Oil Filter.....	
3FD50 (<i>FORKLIFTS</i>) TOYOTA 2H (S/N: 7712-7911)	H-5902	3FG14 (<i>FORKLIFTS</i>) TOYOTA 4P GAS	H-5902	3FG33 (<i>FORKLIFTS</i>) TOYOTA 2F GAS (S/N: 8206-8506)	H-5902
Hydraulic Oil Filter.....		Hydraulic Oil Filter.....		Hydraulic Oil Filter.....	
3FD50 (<i>FORKLIFTS</i>) TOYOTA 2H (S/N: 7912-8009)	H-5902	3FG15 (<i>FORKLIFTS</i>) TOYOTA 4P GAS	H-5902	3FG33 (<i>FORKLIFTS</i>) TOYOTA 2H (S/N: 8004-8008)	H-5902
Hydraulic Oil Filter.....		Hydraulic Oil Filter.....		Hydraulic Oil Filter.....	
3FD50 (<i>FORKLIFTS</i>) TOYOTA 2H (S/N: 8001-8009)	H-5902	3FG20 (<i>FORKLIFTS</i>) TOYOTA 4P GAS 7804 -8003	H-5902	3FG33 (<i>FORKLIFTS</i>) TOYOTA 2H (S/N: 8306-8806)	H-5902
Hydraulic Oil Filter.....		Hydraulic Oil Filter.....		Hydraulic Oil Filter.....	
3FD50 (<i>FORKLIFTS</i>) TOYOTA 2H (S/N: 8010-8305)	H-5902	3FG20 (<i>FORKLIFTS</i>) TOYOTA 4P GAS 8004 -8608	H-5902	3FG35 (<i>FORKLIFTS</i>) TOYOTA 2F GAS 8004	H-5902
Hydraulic Oil Filter.....		Hydraulic Oil Filter.....		Hydraulic Oil Filter.....	
3FD50 (<i>FORKLIFTS</i>) TOYOTA 2H (S/N: 8305-UP)	H-5902	3FG20 (<i>FORKLIFTS</i>) TOYOTA 4P GAS (S/N: 7804-8003)	H-5902	3FG35 (<i>FORKLIFTS</i>) TOYOTA 2F GAS 8101 -8806	H-5902
Hydraulic Oil Filter.....		Hydraulic Oil Filter.....		Hydraulic Oil Filter.....	
3FD60 (<i>FORKLIFTS</i>) TOYOTA 2D 7712 -7908	H-5902	3FG20 (<i>FORKLIFTS</i>) TOYOTA 4P GAS (S/N: 8004-8608)	H-5902	3FG35 (<i>FORKLIFTS</i>) TOYOTA 2H	H-5902
Hydraulic Oil Filter.....		Hydraulic Oil Filter.....		Hydraulic Oil Filter.....	
3FD60 (<i>FORKLIFTS</i>) TOYOTA 2D 7909	H-5902	3FG25 (<i>FORKLIFTS</i>) TOYOTA 5P 7804 -8003	H-5902	3FG35 (<i>FORKLIFTS</i>) TOYOTA 2H 8004 -8008	H-5902
Hydraulic Oil Filter.....		Hydraulic Oil Filter.....		Hydraulic Oil Filter.....	
3FD60 (<i>FORKLIFTS</i>) TOYOTA 2F 7712 -7804	H-5902	3FG25 (<i>FORKLIFTS</i>) TOYOTA 5P 8004 -8608	H-5902	3FG35 (<i>FORKLIFTS</i>) TOYOTA 2H 8306 -8806	H-5902
Hydraulic Oil Filter.....		Hydraulic Oil Filter.....		Hydraulic Oil Filter.....	
3FD60 (<i>FORKLIFTS</i>) TOYOTA 2F 7805	H-5902	3FG25 (<i>FORKLIFTS</i>) TOYOTA 5P (S/N: 7804-8003)	H-5902	3FG40 (<i>FORKLIFTS</i>) TOYOTA 2F GAS 8004	H-5902
Hydraulic Oil Filter.....		Hydraulic Oil Filter.....		Hydraulic Oil Filter.....	
3FD60 (<i>FORKLIFTS</i>) TOYOTA 2H 7712 -7911	H-5902	3FG25 (<i>FORKLIFTS</i>) TOYOTA 5P (S/N: 8004-8608)	H-5902	3FG40 (<i>FORKLIFTS</i>) TOYOTA 2F GAS 8101 -8806	H-5902
Hydraulic Oil Filter.....		Hydraulic Oil Filter.....		Hydraulic Oil Filter.....	
3FD60 (<i>FORKLIFTS</i>) TOYOTA 2H 7912 -8009	H-5902	3FG33 (<i>FORKLIFTS</i>) TOYOTA 2F GAS	H-5902	3FG40 (<i>FORKLIFTS</i>) TOYOTA 2H	H-5902
Hydraulic Oil Filter.....		Hydraulic Oil Filter.....		Hydraulic Oil Filter.....	



ENGINE APPLICATION

MODEL/APPLICATION	SAKURA NO	MODEL/APPLICATION	SAKURA NO	MODEL/APPLICATION	SAKURA NO
TOYOTA		TOYOTA		TOYOTA	
3FG40 (<i>FORKLIFTS</i>) TOYOTA 2H 8004 -8008		3FG60 (<i>FORKLIFTS</i>) TOYOTA 2H 7712 -7911		3SD20 (<i>FORKLIFTS</i>) TOYOTA 2D DIESEL 8102	
Hydraulic Oil Filter.....	H-5902	Hydraulic Oil Filter.....	H-5902	Hydraulic Oil Filter.....	H-5902
3FG40 (<i>FORKLIFTS</i>) TOYOTA 2H 8306 -8806		3FG60 (<i>FORKLIFTS</i>) TOYOTA 2H 8009		3SD20 (<i>FORKLIFTS</i>) TOYOTA 2H 7911 -8009	
Hydraulic Oil Filter.....	H-5902	Hydraulic Oil Filter.....	H-5902	Hydraulic Oil Filter.....	H-5902
3FG50 (<i>FORKLIFTS</i>) TOYOTA 2D DIESEL 7909		3FG60 (<i>FORKLIFTS</i>) TOYOTA 2H 8009 -8305		3SD20 (<i>FORKLIFTS</i>) TOYOTA 2H 8010 -8101	
Hydraulic Oil Filter.....	H-5902	Hydraulic Oil Filter.....	H-5902	Hydraulic Oil Filter.....	H-5902
3FG50 (<i>FORKLIFTS</i>) TOYOTA 2F 7712 -7804		3FGC30 (<i>FORKLIFTS</i>) TOYOTA 2J 8205 -8305		3SD20 (<i>FORKLIFTS</i>) TOYOTA 2H 8102 -8305	
Hydraulic Oil Filter.....	H-5902	Hydraulic Oil Filter.....	H-5902	Hydraulic Oil Filter.....	H-5902
3FG50 (<i>FORKLIFTS</i>) TOYOTA 2F 7805		3FGC30 (<i>FORKLIFTS</i>) TOYOTA 2J 8305 -8311		3SD20 (<i>FORKLIFTS</i>) TOYOTA 2H 8306	
Hydraulic Oil Filter.....	H-5902	Hydraulic Oil Filter.....	H-5902	Hydraulic Oil Filter.....	H-5902
3FG50 (<i>FORKLIFTS</i>) TOYOTA 2H 7712 -7911		3FGC30 (<i>FORKLIFTS</i>) TOYOTA 2J 8311 -8803		3SD20 (<i>FORKLIFTS</i>) TOYOTA 2D DIESEL (S/N: 7911-8101)	
Hydraulic Oil Filter.....	H-5902	Hydraulic Oil Filter.....	H-5902	Hydraulic Oil Filter.....	H-5902
3FG50 (<i>FORKLIFTS</i>) TOYOTA 2H 8009		3FGC30 (<i>FORKLIFTS</i>) TOYOTA 5P 8002 -8803		3SD20 (<i>FORKLIFTS</i>) TOYOTA 2D DIESEL (S/N: 8102-UP)	
Hydraulic Oil Filter.....	H-5902	Hydraulic Oil Filter.....	H-5902	Hydraulic Oil Filter.....	H-5902
3FG50 (<i>FORKLIFTS</i>) TOYOTA 2H 8009 -8305		3FGC30 (<i>FORKLIFTS</i>) TOYOTA 2J (S/N: 8205-8305)		3SD20 (<i>FORKLIFTS</i>) TOYOTA 2H (S/N: 7911-8009)	
Hydraulic Oil Filter.....	H-5902	Hydraulic Oil Filter.....	H-5902	Hydraulic Oil Filter.....	H-5902
3FG50 (<i>FORKLIFTS</i>) TOYOTA 2D DIESEL (S/N: 7909-UP)		3FGC30 (<i>FORKLIFTS</i>) TOYOTA 2J (S/N: 8305-8311)		3SD20 (<i>FORKLIFTS</i>) TOYOTA 2H (S/N: 8010-8101)	
Hydraulic Oil Filter.....	H-5902	Hydraulic Oil Filter.....	H-5902	Hydraulic Oil Filter.....	H-5902
3FG50 (<i>FORKLIFTS</i>) TOYOTA 2F (S/N: 7712-7804)		3FGC30 (<i>FORKLIFTS</i>) TOYOTA 2J (S/N: 8311-8803)		3SD20 (<i>FORKLIFTS</i>) TOYOTA 2H (S/N: 8102-8305)	
Hydraulic Oil Filter.....	H-5902	Hydraulic Oil Filter.....	H-5902	Hydraulic Oil Filter.....	H-5902
3FG50 (<i>FORKLIFTS</i>) TOYOTA 2F (S/N: 7805-UP)		3FGC30 (<i>FORKLIFTS</i>) TOYOTA 5P (S/N: 8002-8803)		3SD20 (<i>FORKLIFTS</i>) TOYOTA 2H (S/N: 8306-UP)	
Hydraulic Oil Filter.....	H-5902	Hydraulic Oil Filter.....	H-5902	Hydraulic Oil Filter.....	H-5902
3FG50 (<i>FORKLIFTS</i>) TOYOTA 2H (S/N: 7712-7911)		3FGCH20 (<i>FORKLIFTS</i>) TOYOTA 5R GAS		3SD23 (<i>FORKLIFTS</i>) TOYOTA 2D DIESEL 7911 -8101	
Hydraulic Oil Filter.....	H-5902	Hydraulic Oil Filter.....	H-5902	Hydraulic Oil Filter.....	H-5902
3FG50 (<i>FORKLIFTS</i>) TOYOTA 2H (S/N: 8009-8305)		3FGCH25 (<i>FORKLIFTS</i>) TOYOTA 5R GAS		3SD23 (<i>FORKLIFTS</i>) TOYOTA 2D DIESEL 8102	
Hydraulic Oil Filter.....	H-5902	Hydraulic Oil Filter.....	H-5902	Hydraulic Oil Filter.....	H-5902
3FG50 (<i>FORKLIFTS</i>) TOYOTA 2H (S/N: 8009-UP)		3FGL20 (<i>FORKLIFTS</i>) TOYOTA 4P		3SD23 (<i>FORKLIFTS</i>) TOYOTA 2H 7911 -8009	
Hydraulic Oil Filter.....	H-5902	Hydraulic Oil Filter.....	H-5902	Hydraulic Oil Filter.....	H-5902
3FG60 (<i>FORKLIFTS</i>) TOYOTA 2D DIESEL 7909		3FGC10 (<i>FORKLIFTS</i>)		3SD23 (<i>FORKLIFTS</i>) TOYOTA 2H 8010 -8101	
Hydraulic Oil Filter.....	H-5902	Hydraulic Oil Filter.....	H-5902	Hydraulic Oil Filter.....	H-5902
3FG60 (<i>FORKLIFTS</i>) TOYOTA 2F 7712 -7804		3FGC10 (<i>FORKLIFTS</i>) S/N: 8810-UP		3SD23 (<i>FORKLIFTS</i>) TOYOTA 2H 8102 -8305	
Hydraulic Oil Filter.....	H-5902	Hydraulic Oil Filter.....	H-5902	Hydraulic Oil Filter.....	H-5902
3FG60 (<i>FORKLIFTS</i>) TOYOTA 2F 7805		3SD20 (<i>FORKLIFTS</i>) TOYOTA 2D DIESEL 7911 -8101		3SD23 (<i>FORKLIFTS</i>) TOYOTA 2H 8306	
Hydraulic Oil Filter.....	H-5902	Hydraulic Oil Filter.....	H-5902	Hydraulic Oil Filter.....	H-5902



ENGINE APPLICATION

MODEL/APPLICATION	SAKURA NO	MODEL/APPLICATION	SAKURA NO	MODEL/APPLICATION	SAKURA NO
TOYOTA					
3SD25 (<i>FORKLIFTS</i>) TOYOTA 2D DIESEL 7911 -8101		40-4FG10 (<i>FORKLIFTS</i>) TOYOTA 5R GAS		42-2FGC15 (<i>FORKLIFTS</i>) TOYOTA 5R GAS	
Hydraulic Oil Filter.....	H-5902	Hydraulic Oil Filter.....	H-5902	Hydraulic Oil Filter.....	H-5902
3SD25 (<i>FORKLIFTS</i>) TOYOTA 2D DIESEL 8102		40-4FG14 (<i>FORKLIFTS</i>) TOYOTA 5R GAS		42-3FG10 (<i>FORKLIFTS</i>) TOYOTA 5R GAS	
Hydraulic Oil Filter.....	H-5902	Hydraulic Oil Filter.....	H-5902	Hydraulic Oil Filter.....	H-5902
3SD25 (<i>FORKLIFTS</i>) TOYOTA 2H 7911 -8009		40-4FG15 (<i>FORKLIFTS</i>) TOYOTA 5R GAS		42-3FG14 (<i>FORKLIFTS</i>) TOYOTA 5R GAS	
Hydraulic Oil Filter.....	H-5902	Hydraulic Oil Filter.....	H-5902	Hydraulic Oil Filter.....	H-5902
3SD25 (<i>FORKLIFTS</i>) TOYOTA 2H 8010 -8101		40-4FG18 (<i>FORKLIFTS</i>) TOYOTA 5R GAS		42-3FG15 (<i>FORKLIFTS</i>) TOYOTA 5R GAS	
Hydraulic Oil Filter.....	H-5902	Hydraulic Oil Filter.....	H-5902	Hydraulic Oil Filter.....	H-5902
3SD25 (<i>FORKLIFTS</i>) TOYOTA 2H 8102 -8305		40-4FG20 (<i>FORKLIFTS</i>) TOYOTA 5R GAS		42-3FG20 (<i>FORKLIFTS</i>) TOYOTA 5R GAS	
Hydraulic Oil Filter.....	H-5902	Hydraulic Oil Filter.....	H-5902	Hydraulic Oil Filter.....	H-5902
3SD25 (<i>FORKLIFTS</i>) TOYOTA 2H 8306		40-4FG23 (<i>FORKLIFTS</i>) TOYOTA 5R GAS		42-3FG25 (<i>FORKLIFTS</i>) TOYOTA 5R GAS	
Hydraulic Oil Filter.....	H-5902	Hydraulic Oil Filter.....	H-5902	Hydraulic Oil Filter.....	H-5902
40-2FG10 (<i>FORKLIFTS</i>) TOYOTA 5R GAS		40-4FG25 (<i>FORKLIFTS</i>) TOYOTA 5R GAS		42-3FGCH20 (<i>FORKLIFTS</i>) TOYOTA 5R GAS	
Hydraulic Oil Filter.....	H-5902	Hydraulic Oil Filter.....	H-5902	Hydraulic Oil Filter.....	H-5902
40-2FG15 (<i>FORKLIFTS</i>) TOYOTA 5R GAS		40/42 2FG 20/25 (<i>FORKLIFTS</i>) 2000-UP		42-3FGCH25 (<i>FORKLIFTS</i>) TOYOTA 5R GAS	
Hydraulic Oil Filter.....	H-5902	Hydraulic Oil Filter.....	H-5902	Hydraulic Oil Filter.....	H-5902
40-2FG20 (<i>FORKLIFTS</i>) TOYOTA 5R GAS		40-FG18 (<i>FORKLIFTS</i>) TOYOTA 5R GAS		42-4FG20 (<i>FORKLIFTS</i>) TOYOTA 5R GAS	
Hydraulic Oil Filter.....	H-5902	Hydraulic Oil Filter.....	H-5902	Hydraulic Oil Filter.....	H-5902
40-2FG25 (<i>FORKLIFTS</i>) TOYOTA 5R GAS		40-FG23 (<i>FORKLIFTS</i>) TOYOTA 5R GAS		42-4FG23 (<i>FORKLIFTS</i>) TOYOTA 5R GAS	
Hydraulic Oil Filter.....	H-5902	Hydraulic Oil Filter.....	H-5902	Hydraulic Oil Filter.....	H-5902
40-3FG10 (<i>FORKLIFTS</i>) TOYOTA 5R GAS		40-FGC18 (<i>FORKLIFTS</i>) TOYOTA 5R GAS		42-4FG25 (<i>FORKLIFTS</i>) TOYOTA 5R GAS	
Hydraulic Oil Filter.....	H-5902	Hydraulic Oil Filter.....	H-5902	Hydraulic Oil Filter.....	H-5902
40-3FG14 (<i>FORKLIFTS</i>) TOYOTA 5R GAS		40-FGC20 (<i>FORKLIFTS</i>) TOYOTA 5R GAS		42-5FG14 (<i>FORKLIFTS</i>)	
Hydraulic Oil Filter.....	H-5902	Hydraulic Oil Filter.....	H-5902	Hydraulic Oil Filter Return.....	H-5901
40-3FG15 (<i>FORKLIFTS</i>) TOYOTA 5R GAS		40-FGC23 (<i>FORKLIFTS</i>) TOYOTA 5R GAS		42-FG18 (<i>FORKLIFTS</i>) TOYOTA 5R GAS	
Hydraulic Oil Filter.....	H-5902	Hydraulic Oil Filter.....	H-5902	Hydraulic Oil Filter.....	H-5902
40-3FG20 (<i>FORKLIFTS</i>) TOYOTA 5R GAS		40-FGC25 (<i>FORKLIFTS</i>) TOYOTA 5R GAS		42-FG23 (<i>FORKLIFTS</i>) TOYOTA 5R GAS	
Hydraulic Oil Filter.....	H-5902	Hydraulic Oil Filter.....	H-5902	Hydraulic Oil Filter.....	H-5902
40-3FG25 (<i>FORKLIFTS</i>) TOYOTA 5R GAS		42-2FG20 (<i>FORKLIFTS</i>) TOYOTA 5R GAS		42-FGC18 (<i>FORKLIFTS</i>) TOYOTA 5R GAS	
Hydraulic Oil Filter.....	H-5902	Hydraulic Oil Filter.....	H-5902	Hydraulic Oil Filter.....	H-5902
40-3FGCH20 (<i>FORKLIFTS</i>) TOYOTA 5R GAS		42-2FG25 (<i>FORKLIFTS</i>) TOYOTA 5R GAS		42-FGC20 (<i>FORKLIFTS</i>) TOYOTA 5R GAS	
Hydraulic Oil Filter.....	H-5902	Hydraulic Oil Filter.....	H-5902	Hydraulic Oil Filter.....	H-5902
40-3FGCH25 (<i>FORKLIFTS</i>) TOYOTA 5R GAS		42-2FGC10 (<i>FORKLIFTS</i>) TOYOTA 5R GAS		42-FGC23 (<i>FORKLIFTS</i>) TOYOTA 5R GAS	
Hydraulic Oil Filter.....	H-5902	Hydraulic Oil Filter.....	H-5902	Hydraulic Oil Filter.....	H-5902



ENGINE APPLICATION

MODEL/APPLICATION	SAKURA NO	MODEL/APPLICATION	SAKURA NO	MODEL/APPLICATION	SAKURA NO
TOYOTA					
42-FGC25 (<i>FORKLIFTS</i>) TOYOTA 5R GAS		4FD20 (<i>FORKLIFTS</i>) TOYOTA 2J DIESEL (S/N: 7810-7911)		4FD23 (<i>FORKLIFTS</i>) TOYOTA 2J DIESEL 8609	
Hydraulic Oil Filter.....	H-5902	Hydraulic Oil Filter.....	H-5902	Hydraulic Oil Filter.....	H-5902
4FD20 (<i>FORKLIFTS</i>) TOYOTA 2J DIESEL 1 -7803		4FD20 (<i>FORKLIFTS</i>) TOYOTA 2J DIESEL (S/N: 7811-8205)		4FD23 (<i>FORKLIFTS</i>) TOYOTA 2JT 8205 -8506	
Hydraulic Oil Filter.....	H-5902	Hydraulic Oil Filter.....	H-5902	Hydraulic Oil Filter.....	H-5902
4FD20 (<i>FORKLIFTS</i>) TOYOTA 2J DIESEL 7804 -7810		4FD20 (<i>FORKLIFTS</i>) TOYOTA 2J DIESEL (S/N: 7912-8205)		4FD23 (<i>FORKLIFTS</i>) TOYOTA 2JT 8507 -8608	
Hydraulic Oil Filter.....	H-5902	Hydraulic Oil Filter.....	H-5902	Hydraulic Oil Filter.....	H-5902
4FD20 (<i>FORKLIFTS</i>) TOYOTA 2J DIESEL 7810 -7911		4FD20 (<i>FORKLIFTS</i>) TOYOTA 2J DIESEL (S/N: 8205-8506)		4FD23 (<i>FORKLIFTS</i>) TOYOTA 4P 7804 -8003	
Hydraulic Oil Filter.....	H-5902	Hydraulic Oil Filter.....	H-5902	Hydraulic Oil Filter.....	H-5902
4FD20 (<i>FORKLIFTS</i>) TOYOTA 2J DIESEL 7811 -8205		4FD20 (<i>FORKLIFTS</i>) TOYOTA 2J DIESEL (S/N: 8507-8608)		4FD23 (<i>FORKLIFTS</i>) TOYOTA 4P 8004 -8506	
Hydraulic Oil Filter.....	H-5902	Hydraulic Oil Filter.....	H-5902	Hydraulic Oil Filter.....	H-5902
4FD20 (<i>FORKLIFTS</i>) TOYOTA 2J DIESEL 7912 -8205		4FD20 (<i>FORKLIFTS</i>) TOYOTA 2J DIESEL (S/N: 8609-UP)		4FD23 (<i>FORKLIFTS</i>) TOYOTA 4P 8507 -8608	
Hydraulic Oil Filter.....	H-5902	Hydraulic Oil Filter.....	H-5902	Hydraulic Oil Filter.....	H-5902
4FD20 (<i>FORKLIFTS</i>) TOYOTA 2J DIESEL 8205 -8506		4FD20 (<i>FORKLIFTS</i>) TOYOTA 4P (S/N: 7804-8003)		4FD23 (<i>FORKLIFTS</i>) TOYOTA 5P 7804 -8003	
Hydraulic Oil Filter.....	H-5902	Hydraulic Oil Filter.....	H-5902	Hydraulic Oil Filter.....	H-5902
4FD20 (<i>FORKLIFTS</i>) TOYOTA 2J DIESEL 8507 -8608		4FD20 (<i>FORKLIFTS</i>) TOYOTA 4P (S/N: 8004-8506)		4FD23 (<i>FORKLIFTS</i>) TOYOTA 5P 8004 -8506	
Hydraulic Oil Filter.....	H-5902	Hydraulic Oil Filter.....	H-5902	Hydraulic Oil Filter.....	H-5902
4FD20 (<i>FORKLIFTS</i>) TOYOTA 2J DIESEL 8609		4FD20 (<i>FORKLIFTS</i>) TOYOTA 4P (S/N: 8507-8608)		4FD23 (<i>FORKLIFTS</i>) TOYOTA 5R 7804 -8003	
Hydraulic Oil Filter.....	H-5902	Hydraulic Oil Filter.....	H-5902	Hydraulic Oil Filter.....	H-5902
4FD20 (<i>FORKLIFTS</i>) TOYOTA 4P 7804 -8003		4FD20 (<i>FORKLIFTS</i>) TOYOTA 5P (S/N: 7804-8003)		4FD23 (<i>FORKLIFTS</i>) TOYOTA 5R 8004 -8608	
Hydraulic Oil Filter.....	H-5902	Hydraulic Oil Filter.....	H-5902	Hydraulic Oil Filter.....	H-5902
4FD20 (<i>FORKLIFTS</i>) TOYOTA 4P 8004 -8506		4FD20 (<i>FORKLIFTS</i>) TOYOTA 5R (S/N: 7804-8003)		4FD23 (<i>FORKLIFTS</i>) TOYOTA 2JT (S/N: 8205-8506)	
Hydraulic Oil Filter.....	H-5902	Hydraulic Oil Filter.....	H-5902	Hydraulic Oil Filter.....	H-5902
4FD20 (<i>FORKLIFTS</i>) TOYOTA 4P 8507 -8608		4FD20 (<i>FORKLIFTS</i>) TOYOTA 5R (S/N: 8004-8608)		4FD23 (<i>FORKLIFTS</i>) TOYOTA 2JT (S/N: 8507-8608)	
Hydraulic Oil Filter.....	H-5902	Hydraulic Oil Filter.....	H-5902	Hydraulic Oil Filter.....	H-5902
4FD20 (<i>FORKLIFTS</i>) TOYOTA 5P 7804 -8003		4FD23 (<i>FORKLIFTS</i>) TOYOTA 2J DIESEL 1 -7803		4FD23 (<i>FORKLIFTS</i>) TOYOTA 5P (S/N: 8004-8506)	
Hydraulic Oil Filter.....	H-5902	Hydraulic Oil Filter.....	H-5902	Hydraulic Oil Filter.....	H-5902
4FD20 (<i>FORKLIFTS</i>) TOYOTA 5R 7804 -8003		4FD23 (<i>FORKLIFTS</i>) TOYOTA 2J DIESEL 7804 -7810		4FD25 (<i>FORKLIFTS</i>) TOYOTA 2J DIESEL 1 -7803	
Hydraulic Oil Filter.....	H-5902	Hydraulic Oil Filter.....	H-5902	Hydraulic Oil Filter.....	H-5902
4FD20 (<i>FORKLIFTS</i>) TOYOTA 5R 8004 -8608		4FD23 (<i>FORKLIFTS</i>) TOYOTA 2J DIESEL 7810 -7911		4FD25 (<i>FORKLIFTS</i>) TOYOTA 2J DIESEL 7804 -7810	
Hydraulic Oil Filter.....	H-5902	Hydraulic Oil Filter.....	H-5902	Hydraulic Oil Filter.....	H-5902
4FD20 (<i>FORKLIFTS</i>) TOYOTA 2J DIESEL (S/N: 1-7803)		4FD23 (<i>FORKLIFTS</i>) TOYOTA 2J DIESEL 7811 -8205		4FD25 (<i>FORKLIFTS</i>) TOYOTA 2J DIESEL 7810 -7911	
Hydraulic Oil Filter.....	H-5902	Hydraulic Oil Filter.....	H-5902	Hydraulic Oil Filter.....	H-5902
4FD20 (<i>FORKLIFTS</i>) TOYOTA 2J DIESEL (S/N: 7804-7810)		4FD23 (<i>FORKLIFTS</i>) TOYOTA 2J DIESEL 7912 -8205		4FD25 (<i>FORKLIFTS</i>) TOYOTA 2J DIESEL 7811 -8205	
Hydraulic Oil Filter.....	H-5902	Hydraulic Oil Filter.....	H-5902	Hydraulic Oil Filter.....	H-5902



ENGINE APPLICATION

MODEL/APPLICATION	SAKURA NO	MODEL/APPLICATION	SAKURA NO	MODEL/APPLICATION	SAKURA NO
TOYOTA		TOYOTA		TOYOTA	
4FD25 (<i>FORKLIFTS</i>) TOYOTA 2J DIESEL 7912 -8205		4FG20 (<i>FORKLIFTS</i>) TOYOTA 4P GAS 8004 -8506		4FG23 (<i>FORKLIFTS</i>) TOYOTA 4P GAS 7804 -8003	
Hydraulic Oil Filter.....	H-5902	Hydraulic Oil Filter.....	H-5902	Hydraulic Oil Filter.....	H-5902
4FD25 (<i>FORKLIFTS</i>) TOYOTA 2J DIESEL 8609		4FG20 (<i>FORKLIFTS</i>) TOYOTA 4P GAS 8507 -8608		4FG23 (<i>FORKLIFTS</i>) TOYOTA 4P GAS 8507 -8608	
Hydraulic Oil Filter.....	H-5902	Hydraulic Oil Filter.....	H-5902	Hydraulic Oil Filter.....	H-5902
4FD25 (<i>FORKLIFTS</i>) TOYOTA 2JT 8205 -8506		4FG20 (<i>FORKLIFTS</i>) TOYOTA 5P 7804 -8003		4FG23 (<i>FORKLIFTS</i>) TOYOTA 5P 7804 -8003	
Hydraulic Oil Filter.....	H-5902	Hydraulic Oil Filter.....	H-5902	Hydraulic Oil Filter.....	H-5902
4FD25 (<i>FORKLIFTS</i>) TOYOTA 4P 8004 -8506		4FG20 (<i>FORKLIFTS</i>) TOYOTA 5P 8004 -8608		4FG23 (<i>FORKLIFTS</i>) TOYOTA 5P 8004 -8608	
Hydraulic Oil Filter.....	H-5902	Hydraulic Oil Filter.....	H-5902	Hydraulic Oil Filter.....	H-5902
4FD25 (<i>FORKLIFTS</i>) TOYOTA 4P 8004 -8506		4FG20 (<i>FORKLIFTS</i>) TOYOTA 2J (S/N: 7804-7810)		4FG25 (<i>FORKLIFTS</i>) TOYOTA 2J 7804 -7810	
Hydraulic Oil Filter.....	H-5902	Hydraulic Oil Filter.....	H-5902	Hydraulic Oil Filter.....	H-5902
4FD25 (<i>FORKLIFTS</i>) TOYOTA 4P 8507 -8608		4FG20 (<i>FORKLIFTS</i>) TOYOTA 2J (S/N: 7811-7911)		4FG25 (<i>FORKLIFTS</i>) TOYOTA 2J 7811 -7911	
Hydraulic Oil Filter.....	H-5902	Hydraulic Oil Filter.....	H-5902	Hydraulic Oil Filter.....	H-5902
4FD25 (<i>FORKLIFTS</i>) TOYOTA 5P 7804 -8003		4FG20 (<i>FORKLIFTS</i>) TOYOTA 2J (S/N: 7912-8205)		4FG25 (<i>FORKLIFTS</i>) TOYOTA 2J 7912 -8205	
Hydraulic Oil Filter.....	H-5902	Hydraulic Oil Filter.....	H-5902	Hydraulic Oil Filter.....	H-5902
4FD25 (<i>FORKLIFTS</i>) TOYOTA 5R 7804 -8003		4FG20 (<i>FORKLIFTS</i>) TOYOTA 2J (S/N: 8206-8608)		4FG25 (<i>FORKLIFTS</i>) TOYOTA 2J 8206 -8608	
Hydraulic Oil Filter.....	H-5902	Hydraulic Oil Filter.....	H-5902	Hydraulic Oil Filter.....	H-5902
4FD25 (<i>FORKLIFTS</i>) TOYOTA 5R 8004 -8608		4FG20 (<i>FORKLIFTS</i>) TOYOTA 4P GAS (S/N: 7804-8003)		4FG25 (<i>FORKLIFTS</i>) TOYOTA 4P GAS 7804 -8003	
Hydraulic Oil Filter.....	H-5902	Hydraulic Oil Filter.....	H-5902	Hydraulic Oil Filter.....	H-5902
4FG10 (<i>FORKLIFTS</i>) TOYOTA 4P GAS		4FG20 (<i>FORKLIFTS</i>) TOYOTA 4P GAS (S/N: 8004-8506)		4FG25 (<i>FORKLIFTS</i>) TOYOTA 4P GAS 8507 -8608	
Hydraulic Oil Filter.....	H-5902	Hydraulic Oil Filter.....	H-5902	Hydraulic Oil Filter.....	H-5902
4FG10 (<i>FORKLIFTS</i>) TOYOTA 4P GAS (S/N: 7804-7900)		4FG20 (<i>FORKLIFTS</i>) TOYOTA 4P GAS (S/N: 8507-8608)		4FG25 (<i>FORKLIFTS</i>) TOYOTA 5P 7804 -8003	
Hydraulic Oil Filter.....	H-5902	Hydraulic Oil Filter.....	H-5902	Hydraulic Oil Filter.....	H-5902
4FG14 (<i>FORKLIFTS</i>) TOYOTA 4P GAS		4FG20 (<i>FORKLIFTS</i>) TOYOTA 5P (S/N: 7804-8003)		4FG25 (<i>FORKLIFTS</i>) TOYOTA 5P 8004 -8608	
Hydraulic Oil Filter.....	H-5902	Hydraulic Oil Filter.....	H-5902	Hydraulic Oil Filter.....	H-5902
4FG20 (<i>FORKLIFTS</i>) TOYOTA 2J 7804 -7810		4FG20 (<i>FORKLIFTS</i>) TOYOTA 5P (S/N: 8004-8608)		4FGC20 (<i>FORKLIFTS</i>) TOYOTA 2J 8002 -8803	
Hydraulic Oil Filter.....	H-5902	Hydraulic Oil Filter.....	H-5902	Hydraulic Oil Filter.....	H-5902
4FG20 (<i>FORKLIFTS</i>) TOYOTA 2J 7811 -7911		4FG23 (<i>FORKLIFTS</i>) TOYOTA 2J 7804 -7810		4FGC20 (<i>FORKLIFTS</i>) TOYOTA 4P GAS 8002 -8008	
Hydraulic Oil Filter.....	H-5902	Hydraulic Oil Filter.....	H-5902	Hydraulic Oil Filter.....	H-5902
4FG20 (<i>FORKLIFTS</i>) TOYOTA 2J 7912 -8205		4FG23 (<i>FORKLIFTS</i>) TOYOTA 2J 7811 -7911		4FGC20 (<i>FORKLIFTS</i>) TOYOTA 4P GAS 8009	
Hydraulic Oil Filter.....	H-5902	Hydraulic Oil Filter.....	H-5902	Hydraulic Oil Filter.....	H-5902
4FG20 (<i>FORKLIFTS</i>) TOYOTA 2J 8206 -8608		4FG23 (<i>FORKLIFTS</i>) TOYOTA 2J 7912 -8205		4FGC20 (<i>FORKLIFTS</i>) TOYOTA 5P 8002 -8009	
Hydraulic Oil Filter.....	H-5902	Hydraulic Oil Filter.....	H-5902	Hydraulic Oil Filter.....	H-5902
4FG20 (<i>FORKLIFTS</i>) TOYOTA 4P GAS 7804 -8003		4FG23 (<i>FORKLIFTS</i>) TOYOTA 2J 8206 -8608		4FGC20 (<i>FORKLIFTS</i>) TOYOTA 5P 8010 -8803	
Hydraulic Oil Filter.....	H-5902	Hydraulic Oil Filter.....	H-5902	Hydraulic Oil Filter.....	H-5902



ENGINE APPLICATION

MODEL/APPLICATION	SAKURA NO	MODEL/APPLICATION	SAKURA NO	MODEL/APPLICATION	SAKURA NO
TOYOTA		TOYOTA		TOYOTA	
4FGC20 (<i>FORKLIFTS</i>) TOYOTA 2J (S/N: 8002-8803)		5FD10 (<i>FORKLIFTS</i>) TOYOTA 2J DIESEL		5FD70 (<i>FORKLIFTS</i>)	
Hydraulic Oil Filter.....	H-5902	Hydraulic Oil Filter Return.....	H-5901	Hydraulic Oil Filter Return.....	H-5901
4FGC20 (<i>FORKLIFTS</i>) TOYOTA 4P GAS (S/N: 8002-8008)		5FD10 (<i>FORKLIFTS</i>) TOYOTA 4P (S/N: 8608-8909)		5FD80 (<i>FORKLIFTS</i>)	
Hydraulic Oil Filter.....	H-5902	Hydraulic Oil Filter Return.....	H-5901	Hydraulic Oil Filter Return.....	H-5901
4FGC20 (<i>FORKLIFTS</i>) TOYOTA 4P GAS (S/N: 8009-8009)		5FD20 (<i>FORKLIFTS</i>) TOYOTA 1Z DIESEL		5FG10 (<i>FORKLIFTS</i>) TOYOTA 4P GAS	
Hydraulic Oil Filter.....	H-5902	Hydraulic Oil Filter Return.....	H-5901	Hydraulic Oil Filter Return.....	H-5901
4FGC20 (<i>FORKLIFTS</i>) TOYOTA 5P (S/N: 8002-8009)		5FD20 (<i>FORKLIFTS</i>) TOYOTA 4P (S/N: 8608-8909)		5FG14 (<i>FORKLIFTS</i>) TOYOTA 4P (S/N: 8608-8909)	
Hydraulic Oil Filter.....	H-5902	Hydraulic Oil Filter Return.....	H-5901	Hydraulic Oil Filter Return.....	H-5901
4FGC20 (<i>FORKLIFTS</i>) TOYOTA 5P (S/N: 8010-8803)		5FD28 (<i>FORKLIFTS</i>) TOYOTA 1Z DIESEL		5FG20 (<i>FORKLIFTS</i>) TOYOTA 4P (S/N: 8608-8909)	
Hydraulic Oil Filter.....	H-5902	Hydraulic Oil Filter Return.....	H-5901	Hydraulic Oil Filter Return.....	H-5901
4FGC25 (<i>FORKLIFTS</i>) TOYOTA 2J 8002 -8803		5FDC20 (<i>FORKLIFTS</i>) TOYOTA 2J (S/N: 8803-8909)		5FG20 (<i>FORKLIFTS</i>) TOYOTA 4P GAS (S/N: 8608-8909)	
Hydraulic Oil Filter.....	H-5902	Hydraulic Oil Filter Return.....	H-5901	Hydraulic Oil Filter Return.....	H-5901
4FGC25 (<i>FORKLIFTS</i>) TOYOTA 4P GAS 8002 -8008		5FDC20 (<i>FORKLIFTS</i>) TOYOTA 2J (S/N: 8910-UP)		5FG28 (<i>FORKLIFTS</i>) TOYOTA 1Z (S/N: 8608-8909)	
Hydraulic Oil Filter.....	H-5902	Hydraulic Oil Filter Return.....	H-5901	Hydraulic Oil Filter Return.....	H-5901
4FGC25 (<i>FORKLIFTS</i>) TOYOTA 4P GAS 8009		5FDC25 (<i>FORKLIFTS</i>)		5FG28 (<i>FORKLIFTS</i>) TOYOTA 1Z (S/N: 8910-UP)	
Hydraulic Oil Filter.....	H-5902	Hydraulic Oil Filter.....	H-5902	Hydraulic Oil Filter Return.....	H-5901
4FGC25 (<i>FORKLIFTS</i>) TOYOTA 5P 8002 -8009		5FDC25 (<i>FORKLIFTS</i>) TOYOTA 4Y (S/N: 8803-8909)		5FG30 (<i>FORKLIFTS</i>) TOYOTA 4Y GAS (S/N: 8608-8909)	
Hydraulic Oil Filter.....	H-5902	Hydraulic Oil Filter Return.....	H-5901	Hydraulic Oil Filter Return.....	H-5901
4FGC25 (<i>FORKLIFTS</i>) TOYOTA 5P 8010 -8803		5FDC25 (<i>FORKLIFTS</i>) TOYOTA 4Y (S/N: 8910-UP)		5FGC10 (<i>FORKLIFTS</i>) TOYOTA 4P 8809	
Hydraulic Oil Filter.....	H-5902	Hydraulic Oil Filter Return.....	H-5901	Hydraulic Oil Filter.....	H-5902
4FGL10 (<i>FORKLIFTS</i>) TOYOTA 4P		5FDC30 (<i>FORKLIFTS</i>) TOYOTA 2J DIESEL (S/N: 8803-8909)		5FGC10 (<i>FORKLIFTS</i>) TOYOTA 4Y 8809	
Hydraulic Oil Filter.....	H-5902	Hydraulic Oil Filter Return.....	H-5901	Hydraulic Oil Filter.....	H-5902
4FGL14 (<i>FORKLIFTS</i>) TOYOTA 4P		5FDC30 (<i>FORKLIFTS</i>) TOYOTA 2J DIESEL (S/N: 8910-UP)		5FGC10 (<i>FORKLIFTS</i>) TOYOTA 4P (S/N: 8809-UP)	
Hydraulic Oil Filter.....	H-5902	Hydraulic Oil Filter Return.....	H-5901	Hydraulic Oil Filter.....	H-5902
4FGL15 (<i>FORKLIFTS</i>) TOYOTA 4P		5FDC30 (<i>FORKLIFTS</i>) TOYOTA 4Y (S/N: 8803-8909)		5FGC10 (<i>FORKLIFTS</i>) TOYOTA 4Y (S/N: 8809-UP)	
Hydraulic Oil Filter.....	H-5902	Hydraulic Oil Filter Return.....	H-5901	Hydraulic Oil Filter.....	H-5902
4FGL18 (<i>FORKLIFTS</i>) TOYOTA 4P		5FDC30 (<i>FORKLIFTS</i>) TOYOTA 4Y (S/N: 8910-UP)		5FGC13 (<i>FORKLIFTS</i>) TOYOTA 4P 8809	
Hydraulic Oil Filter.....	H-5902	Hydraulic Oil Filter Return.....	H-5901	Hydraulic Oil Filter.....	H-5902
4FGL20 (<i>FORKLIFTS</i>) TOYOTA 4P		5FDF10 (<i>FORKLIFTS</i>) TOYOTA FSV, V		5FGC13 (<i>FORKLIFTS</i>) TOYOTA 4Y 8809	
Hydraulic Oil Filter.....	H-5902	Hydraulic Oil Filter Return.....	H-5901	Hydraulic Oil Filter.....	H-5902
4FGL23 (<i>FORKLIFTS</i>) TOYOTA 4P		5FDF10 (<i>FORKLIFTS</i>) TOYOTA FSV, V (S/N: 8912-UP)		5FGC15 (<i>FORKLIFTS</i>) TOYOTA 4P 8809	
Hydraulic Oil Filter.....	H-5902	Hydraulic Oil Filter Return.....	H-5901	Hydraulic Oil Filter.....	H-5902
4FGL25 (<i>FORKLIFTS</i>) TOYOTA 4P		5FDF20 (<i>FORKLIFTS</i>) TOYOTA FSV, V		5FGC15 (<i>FORKLIFTS</i>) TOYOTA 4Y 8809	
Hydraulic Oil Filter.....	H-5902	Hydraulic Oil Filter Return.....	H-5901	Hydraulic Oil Filter.....	H-5902



ENGINE APPLICATION

MODEL/APPLICATION	SAKURA NO	MODEL/APPLICATION	SAKURA NO	MODEL/APPLICATION	SAKURA NO
TOYOTA		TOYOTA		TOYOTA	
5FGC20 (<i>FORKLIFTS</i>) TOYOTA 4Y (S/N: 8803-8909)		60-4FG20 (<i>FORKLIFTS</i>) TOYOTA 5P GAS		Hydraulic Oil Filter Return.....	H-5901
Hydraulic Oil Filter Return.....	H-5901	Hydraulic Oil Filter.....	H-5902	7FD18 (<i>FORKLIFTS</i>)	
5FGC20 (<i>FORKLIFTS</i>) TOYOTA 4Y (S/N: 8910-UP)		60-4FGC20 (<i>FORKLIFTS</i>) TOYOTA 5P GAS		Hydraulic Oil Filter Return.....	H-5901
Hydraulic Oil Filter Return.....	H-5901	Hydraulic Oil Filter.....	H-5902	7FD45 (<i>FORKLIFTS</i>) 7FD45	
5FGC28 (<i>FORKLIFTS</i>) TOYOTA 2J (S/N: 8803-8909)		60-FG18 (<i>FORKLIFTS</i>) TOYOTA 5P GAS		Hydraulic Oil Filter Transmission...	HC-1119
Hydraulic Oil Filter Return.....	H-5901	Hydraulic Oil Filter.....	H-5902	7FD45 (<i>FORKLIFTS</i>)	
5FGC28 (<i>FORKLIFTS</i>) TOYOTA 2J (S/N: 8910-UP)		60-FGC18 (<i>FORKLIFTS</i>) TOYOTA 5P GAS		Hydraulic Oil Filter.....	H-5907
Hydraulic Oil Filter Return.....	H-5901	Hydraulic Oil Filter.....	H-5902	FD100 (<i>FORKLIFTS</i>) 2000-UP	
5FGC28 (<i>FORKLIFTS</i>) TOYOTA 4Y GAS		60-FGL23 (<i>FORKLIFTS</i>) TOYOTA 5P		Hydraulic Oil Filter.....	H-5902
Hydraulic Oil Filter Return.....	H-5901	Hydraulic Oil Filter.....	H-5902	FD100 (<i>FORKLIFTS</i>) S/N: 7212-8403	
5FGC30 (<i>FORKLIFTS</i>) TOYOTA 4Y (S/N: 8803-8909)		62-2FG20 (<i>FORKLIFTS</i>) TOYOTA 5P GAS		Hydraulic Oil Filter.....	H-5902
Hydraulic Oil Filter Return.....	H-5901	Hydraulic Oil Filter.....	H-5902	FD10-18 (<i>FORKLIFTS</i>) TOYOTA 2J DIESEL (S/N: 1-7803)	
5FGC30 (<i>FORKLIFTS</i>) TOYOTA 4Y (S/N: 8910-UP)		62-3FG20 (<i>FORKLIFTS</i>) TOYOTA 5P GAS		Hydraulic Oil Filter.....	H-5902
Hydraulic Oil Filter Return.....	H-5901	Hydraulic Oil Filter.....	H-5902	FD10-18 (<i>FORKLIFTS</i>) TOYOTA 2J DIESEL (S/N: 7804-7809)	
5FGF10 (<i>FORKLIFTS</i>) TOYOTA FSV, V		62-3FGCH20 (<i>FORKLIFTS</i>) TOYOTA 5P GAS		Hydraulic Oil Filter.....	H-5902
Hydraulic Oil Filter Return.....	H-5901	Hydraulic Oil Filter.....	H-5902	FD10-18 (<i>FORKLIFTS</i>) TOYOTA 2J DIESEL (S/N: 7810-8203)	
5FGF10 (<i>FORKLIFTS</i>) TOYOTA FSV, V (S/N: 8912-UP)		62-4FG10 (<i>FORKLIFTS</i>) TOYOTA 5P GAS		Hydraulic Oil Filter.....	H-5902
Hydraulic Oil Filter Return.....	H-5901	Hydraulic Oil Filter.....	H-5902	FD10-18 (<i>FORKLIFTS</i>) TOYOTA 2J DIESEL (S/N: 8204-UP)	
5FGF20 (<i>FORKLIFTS</i>) TOYOTA 1Z		62-4FG20 (<i>FORKLIFTS</i>) TOYOTA 5P GAS		Hydraulic Oil Filter.....	H-5902
Hydraulic Oil Filter Return.....	H-5901	Hydraulic Oil Filter.....	H-5902	FD18 (<i>FORKLIFTS</i>) TOYOTA 4P (S/N: 8009-8608)	
5FG50 (<i>FORKLIFTS</i>)		62-4FGC20 (<i>FORKLIFTS</i>) TOYOTA 5P GAS		Hydraulic Oil Filter.....	H-5902
Hydraulic Oil Filter Return.....	H-5901	Hydraulic Oil Filter.....	H-5902	FD18 (<i>FORKLIFTS</i>) TOYOTA 4P (S/N: 8507-8608)	
5FG70 (<i>FORKLIFTS</i>) 2000-UP		62-FG18 (<i>FORKLIFTS</i>) TOYOTA 5P GAS		Hydraulic Oil Filter.....	H-5902
Hydraulic Oil Filter Return.....	H-5901	Hydraulic Oil Filter.....	H-5902	FD18 (<i>FORKLIFTS</i>) TOYOTA 4P GAS (S/N: 8507-8608)	
60-2FG20 (<i>FORKLIFTS</i>) TOYOTA 5P GAS		62-FG23 (<i>FORKLIFTS</i>) TOYOTA 5P GAS		Hydraulic Oil Filter.....	H-5902
Hydraulic Oil Filter.....	H-5902	Hydraulic Oil Filter.....	H-5902	FD23 (<i>FORKLIFTS</i>) TOYOTA 2J DIESEL (S/N: 1-7803)	
60-2FG25 (<i>FORKLIFTS</i>) TOYOTA 5P GAS		62-FGC18 (<i>FORKLIFTS</i>) TOYOTA 5P GAS		Hydraulic Oil Filter.....	H-5902
Hydraulic Oil Filter.....	H-5902	Hydraulic Oil Filter.....	H-5902	FD23 (<i>FORKLIFTS</i>) TOYOTA 2J DIESEL (S/N: 7804-7810)	
60-3FGCH20 (<i>FORKLIFTS</i>) TOYOTA 5P GAS		6FD18 (<i>FORKLIFTS</i>)		Hydraulic Oil Filter.....	H-5902
Hydraulic Oil Filter.....	H-5902	Hydraulic Oil Filter Return.....	H-5901	FD23 (<i>FORKLIFTS</i>) TOYOTA 2J DIESEL (S/N: 7811-8205)	
60-3FGCH25 (<i>FORKLIFTS</i>) TOYOTA 5P GAS		6GFDU30 (<i>FORKLIFTS</i>) TOYOTA 1Z DIESEL , 1995-1996		Hydraulic Oil Filter.....	H-5902
Hydraulic Oil Filter.....	H-5902	Hydraulic Oil Filter Return.....	H-5901	FD23 (<i>FORKLIFTS</i>) TOYOTA 2J DIESEL (S/N: 8206-8506)	
60-4FG10 (<i>FORKLIFTS</i>) TOYOTA 5P GAS		7FD18 (<i>FORKLIFTS</i>) 7FD18		Hydraulic Oil Filter.....	H-5902
Hydraulic Oil Filter.....	H-5902	Hydraulic Oil Filter Transmission...	HC-1119	FD23 (<i>FORKLIFTS</i>) TOYOTA 2J DIESEL (S/N: 8507-8608)	



ENGINE APPLICATION

MODEL/APPLICATION	SAKURA NO	MODEL/APPLICATION	SAKURA NO	MODEL/APPLICATION	SAKURA NO
TOYOTA					
FD23 (<i>FORKLIFTS</i>) TOYOTA 2J DIESEL (S/N: 8507-8608)	H-5902	FD28 (<i>FORKLIFTS</i>) TOYOTA 5R (S/N: 7804-8009)	H-5902	FDC30 (<i>FORKLIFTS</i>) TOYOTA 2J DIESEL	H-5902
Hydraulic Oil Filter.....		Hydraulic Oil Filter.....		Hydraulic Oil Filter.....	
FD23 (<i>FORKLIFTS</i>) TOYOTA 5P (S/N: 7804-8003)	H-5902	FD40 (<i>FORKLIFTS</i>)	H-5907	FDC15 (<i>FORKLIFTS</i>) TOYOTA 2J DIESEL	H-5902
Hydraulic Oil Filter.....		Hydraulic Oil Filter.....		Hydraulic Oil Filter.....	
FD23 (<i>FORKLIFTS</i>) TOYOTA 5P (S/N: 8004-8608)	H-5902	FD45 (<i>FORKLIFTS</i>) TOYOTA 2F (S/N: 8004-8100)	H-5902	FDC18 (<i>FORKLIFTS</i>) TOYOTA 2J DIESEL (S/N: 1-8001)	H-5902
Hydraulic Oil Filter.....		Hydraulic Oil Filter.....		Hydraulic Oil Filter.....	
FD28 (<i>FORKLIFTS</i>) TOYOTA 2J (S/N: 7811-7911)	H-5902	FD45 (<i>FORKLIFTS</i>) TOYOTA 2F (S/N: 8101-8806)	H-5902	FDC18 (<i>FORKLIFTS</i>) TOYOTA 2J DIESEL (S/N: 8002-8203)	H-5902
Hydraulic Oil Filter.....		Hydraulic Oil Filter.....		Hydraulic Oil Filter.....	
FD28 (<i>FORKLIFTS</i>) TOYOTA 2J (S/N: 7912-8205)	H-5902	FD45 (<i>FORKLIFTS</i>) TOYOTA 2H DIESEL (S/N: 1-8003)	H-5902	FDC18 (<i>FORKLIFTS</i>) TOYOTA 2J DIESEL (S/N: 8204-8304)	H-5902
Hydraulic Oil Filter.....		Hydraulic Oil Filter.....		Hydraulic Oil Filter.....	
FD28 (<i>FORKLIFTS</i>) TOYOTA 2J (S/N: 8606-8608)	H-5902	FD45 (<i>FORKLIFTS</i>) TOYOTA 2H DIESEL (S/N: 8004-8008)	H-5902	FDC18 (<i>FORKLIFTS</i>) TOYOTA 2J DIESEL (S/N: 8305-8311)	H-5902
Hydraulic Oil Filter.....		Hydraulic Oil Filter.....		Hydraulic Oil Filter.....	
FD28 (<i>FORKLIFTS</i>) TOYOTA 2J DIESEL (S/N: 1-7803)	H-5902	FD45 (<i>FORKLIFTS</i>) TOYOTA 2H DIESEL (S/N: 8009-8304)	H-5902	FDC18 (<i>FORKLIFTS</i>) TOYOTA 2J DIESEL (S/N: 8312-8803)	H-5902
Hydraulic Oil Filter.....		Hydraulic Oil Filter.....		Hydraulic Oil Filter.....	
FD28 (<i>FORKLIFTS</i>) TOYOTA 2J DIESEL (S/N: 7804-7810)	H-5902	FD45 (<i>FORKLIFTS</i>) TOYOTA 2H DIESEL (S/N: 8305-8806)	H-5902	FDC18 (<i>FORKLIFTS</i>) TOYOTA 2J DIESEL (S/N: 8804-UP)	H-5902
Hydraulic Oil Filter.....		Hydraulic Oil Filter.....		Hydraulic Oil Filter.....	
FD28 (<i>FORKLIFTS</i>) TOYOTA 2J DIESEL (S/N: 7810-8204)	H-5902	FD45 (<i>FORKLIFTS</i>) TOYOTA 2H DIESEL (S/N: 8807-UP)	H-5902	FDC20 (<i>FORKLIFTS</i>)	H-5902
Hydraulic Oil Filter.....		Hydraulic Oil Filter.....		Hydraulic Oil Filter.....	
FD28 (<i>FORKLIFTS</i>) TOYOTA 2J DIESEL (S/N: 8205-8506)	H-5902	FD70 (<i>FORKLIFTS</i>) TOYOTA 2D (S/N: 7712-7907)	H-5902	FDC28 (<i>FORKLIFTS</i>) TOYOTA 2J (S/N: 8002-8204)	H-5902
Hydraulic Oil Filter.....		Hydraulic Oil Filter.....		Hydraulic Oil Filter.....	
FD28 (<i>FORKLIFTS</i>) TOYOTA 2J DIESEL (S/N: 8507-8606)	H-5902	FD70 (<i>FORKLIFTS</i>) TOYOTA 2D (S/N: 7908-UP)	H-5902	FDC28 (<i>FORKLIFTS</i>) TOYOTA 2J (S/N: 8205-8305)	H-5902
Hydraulic Oil Filter.....		Hydraulic Oil Filter.....		Hydraulic Oil Filter.....	
FD28 (<i>FORKLIFTS</i>) TOYOTA 2JT (S/N: 8205-8608)	H-5902	FD70 (<i>FORKLIFTS</i>) TOYOTA 2F (S/N: 7712-7804)	H-5902	FDC28 (<i>FORKLIFTS</i>) TOYOTA 2J (S/N: 8305-8311)	H-5902
Hydraulic Oil Filter.....		Hydraulic Oil Filter.....		Hydraulic Oil Filter.....	
FD28 (<i>FORKLIFTS</i>) TOYOTA 4P (S/N: 7804-8009)	H-5902	FD70 (<i>FORKLIFTS</i>) TOYOTA 2F (S/N: 7805-UP)	H-5902	FDC28 (<i>FORKLIFTS</i>) TOYOTA 2J (S/N: 8311-8803)	H-5902
Hydraulic Oil Filter.....		Hydraulic Oil Filter.....		Hydraulic Oil Filter.....	
FD28 (<i>FORKLIFTS</i>) TOYOTA 5P (S/N: 7804-8003)	H-5902	FD70 (<i>FORKLIFTS</i>) TOYOTA 2H (S/N: 7712-7911)	H-5902	FDC28 (<i>FORKLIFTS</i>) TOYOTA 5P (S/N: 8002-8009)	H-5902
Hydraulic Oil Filter.....		Hydraulic Oil Filter.....		Hydraulic Oil Filter.....	
FD28 (<i>FORKLIFTS</i>) TOYOTA 5P (S/N: 7804-8009)	H-5902	FD70 (<i>FORKLIFTS</i>) TOYOTA 2H (S/N: 7912-8008)	H-5902	FDC28 (<i>FORKLIFTS</i>) TOYOTA 5P (S/N: 8010-8803)	H-5902
Hydraulic Oil Filter.....		Hydraulic Oil Filter.....		Hydraulic Oil Filter.....	
FD28 (<i>FORKLIFTS</i>) TOYOTA 5P (S/N: 8004-8506)	H-5902	FD70 (<i>FORKLIFTS</i>) TOYOTA 2H (S/N: 8009-8305)	H-5902	FDC33 (<i>FORKLIFTS</i>) TOYOTA 2F (S/N: 8812-UP)	H-5902
Hydraulic Oil Filter.....		Hydraulic Oil Filter.....		Hydraulic Oil Filter.....	
FD28 (<i>FORKLIFTS</i>) TOYOTA 5P GAS (S/N: 8507-8608)	H-5902	FD70 (<i>FORKLIFTS</i>) TOYOTA 2H (S/N: 8306-UP)	H-5902	FDC33 (<i>FORKLIFTS</i>) TOYOTA 2H (S/N: 8212-8305)	H-5902
Hydraulic Oil Filter.....		Hydraulic Oil Filter.....		Hydraulic Oil Filter.....	



ENGINE APPLICATION

MODEL/APPLICATION	SAKURA NO	MODEL/APPLICATION	SAKURA NO	MODEL/APPLICATION	SAKURA NO
TOYOTA					
FDC33 (<i>FORKLIFTS</i>) TOYOTA 2H (S/N: 8306-8811)		FG23 (<i>FORKLIFTS</i>) TOYOTA 4P (S/N: 8507-8608)		FGC30 (<i>FORKLIFTS</i>) TOYOTA 5R GAS	
Hydraulic Oil Filter.....	H-5902	Hydraulic Oil Filter.....	H-5902	Hydraulic Oil Filter.....	H-5902
FDC33 (<i>FORKLIFTS</i>) TOYOTA 2H (S/N: 8812-UP)		FG28 (<i>FORKLIFTS</i>) TOYOTA 2J (S/N: 7804-7810)		FGC18 (<i>FORKLIFTS</i>) TOYOTA 4P GAS	
Hydraulic Oil Filter.....	H-5902	Hydraulic Oil Filter.....	H-5902	Hydraulic Oil Filter.....	H-5902
FDE35 (<i>FORKLIFTS</i>) TOYOTA 2F (S/N: 8004-8008)		FG28 (<i>FORKLIFTS</i>) TOYOTA 2J (S/N: 7811-7911)		FGC18 (<i>FORKLIFTS</i>) TOYOTA 4P (S/N: 8002-8803)	
Hydraulic Oil Filter.....	H-5902	Hydraulic Oil Filter.....	H-5902	Hydraulic Oil Filter.....	H-5902
FDE35 (<i>FORKLIFTS</i>) TOYOTA 2F (S/N: 8005-100)		FG28 (<i>FORKLIFTS</i>) TOYOTA 2J (S/N: 7912-8205)		FGC28 (<i>FORKLIFTS</i>) TOYOTA 2J (S/N: 8002-8204)	
Hydraulic Oil Filter.....	H-5902	Hydraulic Oil Filter.....	H-5902	Hydraulic Oil Filter.....	H-5902
FDE35 (<i>FORKLIFTS</i>) TOYOTA 2F (S/N: 8009-8806)		FG28 (<i>FORKLIFTS</i>) TOYOTA 2J DIESEL (S/N: 8206-8507)		FGC28 (<i>FORKLIFTS</i>) TOYOTA 2J (S/N: 8205-8305)	
Hydraulic Oil Filter.....	H-5902	Hydraulic Oil Filter.....	H-5902	Hydraulic Oil Filter.....	H-5902
FDE35 (<i>FORKLIFTS</i>) TOYOTA 2F (S/N: 8101-8606)		FG28 (<i>FORKLIFTS</i>) TOYOTA 2J DIESEL (S/N: 8507-8608)		FGC28 (<i>FORKLIFTS</i>) TOYOTA 2J (S/N: 8305-8311)	
Hydraulic Oil Filter.....	H-5902	Hydraulic Oil Filter.....	H-5902	Hydraulic Oil Filter.....	H-5902
FDE35 (<i>FORKLIFTS</i>) TOYOTA 2F (S/N: 8807-UP)		FG28 (<i>FORKLIFTS</i>) TOYOTA 2JT (S/N: 8205-8608)		FGC28 (<i>FORKLIFTS</i>) TOYOTA 2J (S/N: 8311-8803)	
Hydraulic Oil Filter.....	H-5902	Hydraulic Oil Filter.....	H-5902	Hydraulic Oil Filter.....	H-5902
FDE35 (<i>FORKLIFTS</i>) TOYOTA 2H DIESEL (S/N: 1-8003)		FG28 (<i>FORKLIFTS</i>) TOYOTA 4P (S/N: 7804-8009)		FGC28 (<i>FORKLIFTS</i>) TOYOTA 5P (S/N: 8002-8009)	
Hydraulic Oil Filter.....	H-5902	Hydraulic Oil Filter.....	H-5902	Hydraulic Oil Filter.....	H-5902
FDE35 (<i>FORKLIFTS</i>) TOYOTA 2H DIESEL (S/N: 8004-80088)		FG28 (<i>FORKLIFTS</i>) TOYOTA 5P (S/N: 7804-8009)		FGC28 (<i>FORKLIFTS</i>) TOYOTA 5P (S/N: 8010-8803)	
Hydraulic Oil Filter.....	H-5902	Hydraulic Oil Filter.....	H-5902	Hydraulic Oil Filter.....	H-5902
FDE35 (<i>FORKLIFTS</i>) TOYOTA 2H DIESEL (S/N: 8009-8304)		FG28 (<i>FORKLIFTS</i>) TOYOTA 5P GAS (S/N: 7804-8608)		FGC33 (<i>FORKLIFTS</i>) TOYOTA 2H	
Hydraulic Oil Filter.....	H-5902	Hydraulic Oil Filter.....	H-5902	Hydraulic Oil Filter.....	H-5902
FDE35 (<i>FORKLIFTS</i>) TOYOTA 2H DIESEL (S/N: 8305-8606)		FG28 (<i>FORKLIFTS</i>) TOYOTA 5P GAS (S/N: 8507-8608)		FGC33 (<i>FORKLIFTS</i>) TOYOTA 2F (S/N: 8212-UP)	
Hydraulic Oil Filter.....	H-5902	Hydraulic Oil Filter.....	H-5902	Hydraulic Oil Filter.....	H-5902
FDE35 (<i>FORKLIFTS</i>) TOYOTA 2H DIESEL (S/N: 8807-UP)		FG28 (<i>FORKLIFTS</i>) TOYOTA 5R (S/N: 7804-8009)		FGC33 (<i>FORKLIFTS</i>) TOYOTA 2H (S/N: 8212-UP)	
Hydraulic Oil Filter.....	H-5902	Hydraulic Oil Filter.....	H-5902	Hydraulic Oil Filter.....	H-5902
FDT25 (<i>FORKLIFTS</i>) S/N: 8907-UP		FG30 (<i>FORKLIFTS</i>) TOYOTA 4P GAS		FGC33 (<i>FORKLIFTS</i>) TOYOTA 2H (S/N: 8306-8306)	
Hydraulic Oil Filter.....	H-5902	Hydraulic Oil Filter.....	H-5902	Hydraulic Oil Filter.....	H-5902
FG18 (<i>FORKLIFTS</i>) TOYOTA 4P (S/N: 8004-8608)		FG45 (<i>FORKLIFTS</i>) TOYOTA 2F GAS (S/N: 8004-8100)		FGE35 (<i>FORKLIFTS</i>) TOYOTA 2F GAS (S/N: 8004-8100)	
Hydraulic Oil Filter.....	H-5902	Hydraulic Oil Filter.....	H-5902	Hydraulic Oil Filter.....	H-5902
FG18 (<i>FORKLIFTS</i>) TOYOTA 4P (S/N: 8507-8608)		FG45 (<i>FORKLIFTS</i>) TOYOTA 2F GAS (S/N: 8101-8806)		FGE35 (<i>FORKLIFTS</i>) TOYOTA 2F GAS (S/N: 8101-8806)	
Hydraulic Oil Filter.....	H-5902	Hydraulic Oil Filter.....	H-5902	Hydraulic Oil Filter.....	H-5902
FG23 (<i>FORKLIFTS</i>) TOYOTA 4P GAS		FG45 (<i>FORKLIFTS</i>) TOYOTA 2H (S/N: 8009-8305)		FGL18 (<i>FORKLIFTS</i>) TOYOTA 4P	
Hydraulic Oil Filter.....	H-5902	Hydraulic Oil Filter.....	H-5902	Hydraulic Oil Filter.....	H-5902
FG23 (<i>FORKLIFTS</i>) TOYOTA 4P (S/N: 8004-8506)		FG45 (<i>FORKLIFTS</i>) TOYOTA 2H (S/N: 8306-8806)		FGL23 (<i>FORKLIFTS</i>) TOYOTA 4P	
Hydraulic Oil Filter.....	H-5902	Hydraulic Oil Filter.....	H-5902	Hydraulic Oil Filter.....	H-5902



ENGINE APPLICATION

MODEL/APPLICATION	SAKURA NO	MODEL/APPLICATION	SAKURA NO	MODEL/APPLICATION	SAKURA NO
TOYOTA		VALMET		VALMET	
(ENGINES) TOYOTA SX (P/D 7702-8805)		2005 (TRACTORS) VOLVO TD60K		JEHU 522 (FOREST EQUIPMENTS) VALMET 310B	
Hydraulic Oil Filter.....	H-5902	Hydraulic Oil Filter.....	HC-6802	Hydraulic Oil Filter Transmission...	H-65030
(ENGINES) TOYOTA SY (P/D 7702-7707)		524 (FOREST EQUIPMENTS) FORD		JEHU 920 (FOREST EQUIPMENTS) VALMET 411A	
Hydraulic Oil Filter.....	H-5902	Hydraulic Oil Filter Transmission...	HC-1902	Hydraulic Oil Filter Transmission...	H-65030
(ENGINES) TOYOTA SY (P/D 7707-7810)		544H (FOREST EQUIPMENTS) FORD TURBO		VERMEER	
Hydraulic Oil Filter.....	H-5902	Hydraulic Oil Filter Transmission...	HC-1902	T650 (TRENCHERS) GMC 8.2T	
(ENGINES) TOYOTA SY (P/D 7810-8805)		800 (TRACTORS) VALMET 411BS		Hydraulic Oil Filter.....	HC-5507
Hydraulic Oil Filter.....	H-5902	Hydraulic Oil Filter Transmission...	H-65030	VERREIKER MERLO	
SD20 (FORKLIFTS) S/N: 7706-UP		800 (TRACTORS) VALMET 411CS		ROTO 40.18 EV (CRANES) PERKINS 1004	
Hydraulic Oil Filter.....	H-5902	Hydraulic Oil Filter Transmission...	H-65030	Hydraulic Oil Filter.....	HC-57020
SD20 (FORKLIFTS) S/N: 7909-UP		8300 (TRACTORS) VALMET 612D		VERSATILE	
Hydraulic Oil Filter.....	H-5902	Hydraulic Oil Filter Transmission...	HC-51060	103 (AGRICULTURE) WISCONSIN VG-4D	
SDK10 (FORKLIFTS) S/N: 8902-UP		840.2 (FOREST EQUIPMENTS) SISU		Hydraulic Oil Filter.....	HC-7932
Hydraulic Oil Filter.....	HC-7972	Hydraulic Oil Filter.....	HC-57020	103 (AGRICULTURE) WISCONSIN VH-4D	
TROJAN		870 (FOREST EQUIPMENTS) VALMET 411A		Hydraulic Oil Filter.....	HC-7932
2000 (LOADERS) CUMMINS V-470C		Hydraulic Oil Filter.....	H-51170	1150 (TRACTORS) CUMMINS KTA-1150	
Hydraulic Oil Filter Transmission...	H-65030	Hydraulic Oil Filter Transmission...	H-65030	Hydraulic Oil Filter.....	H-57030
404 (LOADERS) CUMMINS NH250		872 (FOREST EQUIPMENTS) VALMET 411BS		1156 (TRACTORS) CUMMINS KTA-1150	
Hydraulic Oil Filter Transmission...	H-65030	Hydraulic Oil Filter.....	H-51170	Hydraulic Oil Filter.....	H-57030
404 (LOADERS) DETROIT 8V-71		8800 (TRACTORS) VALMET 634DS		150 (AGRICULTURE) PERKINS 4 CYL	
Hydraulic Oil Filter Transmission...	H-65030	Hydraulic Oil Filter Transmission...	HC-51060	Hydraulic Oil Filter.....	HC-7932
5500Z (LOADERS)		880K (FOREST EQUIPMENTS) VALMET 411AS		256 (TRACTORS) CONSOLDI CONSOLIDATED DIESEL	
Hydraulic Oil Filter.....	H-5618	Hydraulic Oil Filter.....	H-51170	Hydraulic Oil Filter.....	HC-7927
VALMET		Hydraulic Oil Filter Transmission...	H-65030	300 (AGRICULTURE) CUMMINS V6-140	
1000 (TRACTORS)		882K (FOREST EQUIPMENTS) SCANIA D55		Hydraulic Oil Filter.....	HC-5511
Hydraulic Oil Filter Transmission...	H-65030	Hydraulic Oil Filter Transmission...	H-65030	Hydraulic Oil Filter.....	HC-7932
1200 (TRACTORS) PERKINS 6.354		882K (FOREST EQUIPMENTS) VALMET 611CS		Hydraulic Oil Filter.....	HC-5511
Hydraulic Oil Filter Transmission...	H-65030	Hydraulic Oil Filter Transmission...	H-65030	330 (SWATHER)	
1200B (TRACTORS) VALMET 611CS		8850 (TRACTORS) VALMET 634DS		Hydraulic Oil Filter.....	HC-1903
Hydraulic Oil Filter Transmission...	H-65030	Hydraulic Oil Filter.....	H-5001	400 SWATHER (AGRICULTURE) FORD 200	
1200B (TRACTORS) VOLVO TD70B		941 (FOREST EQUIPMENTS) SISU 84CTA (S/N: 12040-UP) , 2008-UP		Hydraulic Oil Filter.....	HC-7932
Hydraulic Oil Filter Transmission...	H-65030	Hydraulic Oil Filter.....	HC-57020	400 SWATHER (AGRICULTURE) WISCONSIN WISCONSIN	
2005 (TRACTORS) VOLVO TD60B		941 (FOREST EQUIPMENTS) SISU 84CTA (S/N: 12041-UP) , 2008-UP		Hydraulic Oil Filter.....	HC-7932
Hydraulic Oil Filter.....	HC-6802	Hydraulic Oil Filter.....	HC-57020	420 (AGRICULTURE) FORD FORD GAS	
				Hydraulic Oil Filter.....	HC-7932



ENGINE APPLICATION

MODEL/APPLICATION	SAKURA NO	MODEL/APPLICATION	SAKURA NO	MODEL/APPLICATION	SAKURA NO
VERSATILE		VERSATILE		VERSATILE	
440 (AGRICULTURE) FORD FORD		705 SERIES 2 (AGRICULTURE) CUMMINS V-903		Hydraulic Oil Filter.....	H-79411
Hydraulic Oil Filter.....	HC-7932	Hydraulic Oil Filter.....	HC-7932	D118 (TRACTORS) CUMMINS V8-185	
4400 SWATHER (AGRICULTURE) FORD 6 CYL 200		Hydraulic Oil Filter.....	H-51170	Hydraulic Oil Filter.....	H-79411
Hydraulic Oil Filter.....	HC-7932	750 (AGRICULTURE) CUMMINS V-555		D118 (TRACTORS) CUMMINS V-352	
500 (TRACTORS) CUMMINS V-504		Hydraulic Oil Filter.....	HC-7932	Hydraulic Oil Filter.....	H-79411
Hydraulic Oil Filter.....	H-51170	Hydraulic Oil Filter.....	H-51170	D145 (TRACTORS) CUMMINS V8-185	
5000 (COMBINES) FORD V8-360		800 (AGRICULTURE) CUMMINS N-855		Hydraulic Oil Filter.....	H-79411
Hydraulic Oil Filter.....	H-51170	Hydraulic Oil Filter.....	HC-7932	VME (VOLVO BM/MICH./EUCLID)	
555 (TRACTORS) CUMMINS V-555		Hydraulic Oil Filter.....	H-51170	280C (LOADERS) CUMMINS NTA-855	
Hydraulic Oil Filter.....	H-51170	825 (AGRICULTURE) CUMMINS N-855		Hydraulic Oil Filter.....	HC-5503
700 (AGRICULTURE) CUMMINS V-555		Hydraulic Oil Filter.....	HC-7932	380 (LOADERS) CUMMINS VTA28-C , 1993	
Hydraulic Oil Filter.....	HC-7932	Hydraulic Oil Filter.....	H-51170	Hydraulic Oil Filter.....	HC-5503
Hydraulic Oil Filter.....	HC-5511	835 (TRACTORS) CUMMINS NTA-855		380B (LOADERS)	
Hydraulic Oil Filter.....	H-51170	Hydraulic Oil Filter.....	H-51170	Hydraulic Oil Filter.....	HC-5503
Hydraulic Oil Filter.....	HC-5511	846 (TRACTORS) CUMMINS LTA10		4200 (LOADERS)	
700 SERIES 2 (AGRICULTURE) CUMMINS CUMMINS		Hydraulic Oil Filter.....	HC-7927	Hydraulic Oil Filter.....	HC-7913
Hydraulic Oil Filter.....	HC-7932	850 (TRACTORS) CUMMINS		Hydraulic Oil Filter.....	H-85110
700 SERIES 2 (TRACTORS) CUMMINS		Hydraulic Oil Filter.....	H-51170	Hydraulic Oil Filter.....	HC-6802
Hydraulic Oil Filter.....	H-51170	855 (TRACTORS) CUMMINS NTA-855		4300 (LOADERS)	
701 SERIES 2 (AGRICULTURE) CUMMINS CUMMINS		Hydraulic Oil Filter.....	H-51170	Hydraulic Oil Filter.....	H-85110
Hydraulic Oil Filter.....	HC-7932	875 (TRACTORS) CUMMINS NTA-855		Hydraulic Oil Filter.....	HC-6802
701 SERIES 2 (TRACTORS) CUMMINS		Hydraulic Oil Filter.....	H-51170	4400 (LOADERS)	
Hydraulic Oil Filter.....	H-51170	895 (TRACTORS) CUMMINS NTA-855		Hydraulic Oil Filter.....	HC-6802
702 SERIES 2 (AGRICULTURE) CUMMINS CUMMINS		Hydraulic Oil Filter.....	H-51170	Hydraulic Oil Filter.....	H-85110
Hydraulic Oil Filter.....	HC-7932	900 (TRACTORS) CUMMINS V-903		4500 (LOADERS) VME TD70G	
702 SERIES 2 (TRACTORS) CUMMINS		Hydraulic Oil Filter.....	H-51170	Hydraulic Oil Filter.....	HC-6802
Hydraulic Oil Filter.....	H-51170	935 (TRACTORS) CUMMINS VT-903		Hydraulic Oil Filter.....	H-85110
703 SERIES 2 (AGRICULTURE) CUMMINS CUMMINS		Hydraulic Oil Filter.....	H-51170	4500 (LOADERS) VME TD70H	
Hydraulic Oil Filter.....	HC-7932	945 (TRACTORS) CUMMINS NT-855		Hydraulic Oil Filter.....	HC-6802
703 SERIES 2 (TRACTORS) CUMMINS		Hydraulic Oil Filter.....	H-51170	Hydraulic Oil Filter.....	H-85110
Hydraulic Oil Filter.....	H-51170	955 (TRACTORS) CUMMINS NT-855		4600 (LOADERS) VME TD100A	
704 SERIES 2 (AGRICULTURE) CUMMINS CUMMINS		Hydraulic Oil Filter.....	H-51170	Hydraulic Oil Filter.....	HC-6802
Hydraulic Oil Filter.....	HC-7932	975 (TRACTORS) CUMMINS NT BIG CAM III		Hydraulic Oil Filter.....	HC-6802
704 SERIES 2 (TRACTORS) CUMMINS		Hydraulic Oil Filter.....	H-51170	4600B (LOADERS)	
Hydraulic Oil Filter.....	H-51170	D118 (TRACTORS) CUMMINS V6-140		Hydraulic Oil Filter.....	HC-6802



ENGINE APPLICATION

MODEL/APPLICATION	SAKURA NO	MODEL/APPLICATION	SAKURA NO	MODEL/APPLICATION	SAKURA NO
VME (VOLVO BM/MICH./EUCLID)		VME (VOLVO BM/MICH./EUCLID)		VME (VOLVO BM/MICH./EUCLID)	
6300 (LOADERS)		Hydraulic Oil Filter.....	H-71130	Hydraulic Oil Filter.....	H-85110
Hydraulic Oil Filter.....	HC-6802	Hydraulic Oil Filter.....	HC-5504	VOGELE	
Hydraulic Oil Filter.....	H-85110	L190 (LOADERS) CUMMINS NTA-855		V1600 (FINISHERS) KHD BF6L913	
A20 (DUMP TRUCKS) VOLVO TD71G		Hydraulic Oil Filter.....	HC-5503	Hydraulic Oil Filter.....	HC-6801
Hydraulic Oil Filter.....	H-85110	L190B (LOADERS) VOLVO		Hydraulic Oil Filter.....	HC-7906
A25 (DUMP TRUCKS) VOLVO TD71K		Hydraulic Oil Filter.....	H-85110	Hydraulic Oil Filter.....	H-4904
Hydraulic Oil Filter Transmission....	H-7102	L270 (LOADERS) CUMMINS KT-19		VOLVO	
Hydraulic Oil Filter.....	H-85110	Hydraulic Oil Filter.....	HC-5503	2200/04 (AGRICULTURE) 2200/04	
A35 (DUMP TRUCKS) VOLVO TD121G		L30 (LOADERS) PERKINS 4.236		Hydraulic Oil Filter.....	H-5410
Hydraulic Oil Filter.....	H-85110	Hydraulic Oil Filter.....	H-85110	2250/54 (AGRICULTURE) 2250/54	
Hydraulic Oil Filter.....	HC-5508	Hydraulic Oil Filter.....	HC-7913	Hydraulic Oil Filter.....	H-5410
DR861 (DUMP TRUCKS) VOLVO		L320 (LOADERS) CUMMINS KTA-19C		290BLC (EXCAVATORS)	
Hydraulic Oil Filter.....	HC-6802	Hydraulic Oil Filter.....	HC-5503	Hydraulic Oil Filter Full Flow.....	HC-7901
Hydraulic Oil Filter.....	H-85110	L380B (LOADERS) CUMMINS , 1993		5350 (CONSTRUCTION & MINING) VOLVO TD70G	
F665 (SKIDDERS)		Hydraulic Oil Filter.....	HC-5503	Hydraulic Oil Filter Transmission....	H-65030
Hydraulic Oil Filter.....	HC-7913	L480 (LOADERS) CUMMINS VTA28-C		7700 (BUSES) VOLVO D9B-260 (S/N: EURO4/5-UP) , 2006-UP	
F666 (SKIDDERS)		Hydraulic Oil Filter.....	HC-5503	Hydraulic Oil Filter.....	HC-8805
Hydraulic Oil Filter.....	HC-6501	L50 (LOADERS) VOLVOBM D45B		7700 (BUSES) VOLVO D9B-310 (S/N: EURO4/5-UP) , 2006-UP	
F667 (SKIDDERS)		Hydraulic Oil Filter.....	H-85110	Hydraulic Oil Filter.....	HC-8805
Hydraulic Oil Filter.....	HC-6501	Hydraulic Oil Filter.....	HC-6802	7700 (BUSES) VOLVO D9B-360 (S/N: EURO4/5-UP) , 2006-UP	
F668 (SKIDDERS)		L50B (LOADERS)		Hydraulic Oil Filter.....	HC-8805
Hydraulic Oil Filter.....	HC-6501	Hydraulic Oil Filter.....	H-85560	8500 (TX) (BUSES) VOLVO DH12E (S/N: EURO4-UP) , 2006-UP	
L120 (LOADERS) VOLVO TD71G		Hydraulic Oil Filter.....	HC-5508	Hydraulic Oil Filter.....	HC-8805
Hydraulic Oil Filter.....	H-85110	Hydraulic Oil Filter.....	HC-6802	9700 (BUSES) VOLVO DH12E (S/N: EURO4/5-UP) , 2006-UP	
L140 (LOADERS)		L50C (LOADERS) VME TD40GA		Hydraulic Oil Filter.....	HC-8805
Hydraulic Oil Filter.....	HC-6501	Hydraulic Oil Filter.....	HC-5508	A20C (DUMP TRUCKS) VOLVO TD73 , 1995	
L-150 (LOADERS) VOLVO TD102GC , 1992		Hydraulic Oil Filter.....	H-85560	Hydraulic Oil Filter.....	HC-5508
Hydraulic Oil Filter.....	HC-5508	Hydraulic Oil Filter.....	HC-6802	A25C (DUMP TRUCKS)	
Hydraulic Oil Filter.....	H-71130	Hydraulic Oil Filter.....	H-85560	Hydraulic Oil Filter Transmission....	H-7102
L160 (LOADERS)		Hydraulic Oil Filter.....	HC-6802	A25D (DUMP TRUCKS) VOLVO D10B , 2001-UP	
Hydraulic Oil Filter.....	HC-6802	L50C (LOADERS) VME TD40KAE		Hydraulic Oil Filter.....	HC-5508
Hydraulic Oil Filter.....	HC-5503	Hydraulic Oil Filter.....	HC-5508	A30C (DUMP TRUCKS) VOLVO TD104 , 1997-2001	
Hydraulic Oil Filter.....	H-85110	Hydraulic Oil Filter.....	HC-6802	Hydraulic Oil Filter.....	HC-5508
L160 (LOADERS) VOLVO TD102		Hydraulic Oil Filter.....	H-85560	A30C (DUMP TRUCKS) VOLVO TD103 , 1996-1997	
Hydraulic Oil Filter.....	HC-6802	L70 (LOADERS) VOLVOBM TD45B		Hydraulic Oil Filter.....	HC-5508
Hydraulic Oil Filter.....	H-85110	Hydraulic Oil Filter.....	H-85110	A30C (DUMP TRUCKS) VOLVO TD103 , 1996-1997	
L180 (LOADERS) VOLVO TD122		Hydraulic Oil Filter.....	HC-6802	Hydraulic Oil Filter.....	HC-5508
Hydraulic Oil Filter.....	H-85110	L70B (LOADERS)			
		Hydraulic Oil Filter.....	HC-6802		
		L90 (LOADERS) VOLVO TD61G			



ENGINE APPLICATION

MODEL/APPLICATION	SAKURA NO	MODEL/APPLICATION	SAKURA NO	MODEL/APPLICATION	SAKURA NO
VOLVO					
A30C (DUMP TRUCKS)		B10R (BUSES) VOLVO THD102K , 1978-1992		B57 (BUSES) VOLVO D70A , 1975-1981	
Hydraulic Oil Filter.....	HC-5508	Hydraulic Oil Filter Transmission....	H-7102	Hydraulic Oil Filter.....	H-7914
A35C (DUMP TRUCKS)		Hydraulic Oil Filter Transmission....	H-65030	B57 (BUSES) VOLVO TD70A , 1975-1981	
Hydraulic Oil Filter.....	HC-5508	B10R (BUSES) VOLVO THD104 K , 1978-1992		Hydraulic Oil Filter.....	H-7914
A40 (DUMP TRUCKS)		Hydraulic Oil Filter Transmission....	H-65030	B57 (BUSES) VOLVO D70B , 1975-1981	
Hydraulic Oil Filter.....	HC-5508	Hydraulic Oil Filter Transmission....	H-7102	Hydraulic Oil Filter.....	H-7914
A40D (DUMP TRUCKS) 2000-UP		B10R (BUSES) VOLVO THD100E , 1978-1992		B57 (BUSES) VOLVO TD70B , 1975-1981	
Hydraulic Oil Filter.....	H-85560	Hydraulic Oil Filter Transmission....	H-7102	Hydraulic Oil Filter.....	H-7914
Hydraulic Oil Filter.....	HC-5508	Hydraulic Oil Filter Transmission....	H-65030	B57 (BUSES) VOLVO E , 1975-1981	
A40E (DUMP TRUCKS) 2007-UP		Hydraulic Oil Filter Transmission....	H-7102	Hydraulic Oil Filter.....	H-7914
Hydraulic Oil Filter.....	HC-5504	B10B (BUSES) VOLVO THD101G , 1992-UP		B57 (BUSES) VOLVO H , 1975-1981	
B10 (BUSES) VOLVO TD100 , 1979-1985		Hydraulic Oil Filter Transmission....	H-7102	Hydraulic Oil Filter.....	H-7914
Hydraulic Oil Filter Transmission....	H-65030	Hydraulic Oil Filter Transmission....	H-7102	B58 (BUSES) VOLVO D50A , 1979-1983	
B10 (BUSES) VOLVO TD100B , 1979-1985		Hydraulic Oil Filter Transmission....	H-7102	Hydraulic Oil Filter.....	H-7914
Hydraulic Oil Filter Transmission....	H-65030	B10L (BUSES) VOLVO THD101G , 1992-UP		B58 (BUSES) VOLVO HD100A , 1979-1983	
B10 (BUSES) VOLVO THD100EC , 1979-1985		Hydraulic Oil Filter Transmission....	H-7102	Hydraulic Oil Filter.....	H-7914
Hydraulic Oil Filter Transmission....	H-65030	Hydraulic Oil Filter Transmission....	H-7102	B58 (BUSES) VOLVO THD100A , 1979-1983	
B10M (BUSES) VOLVO THD101G , 1992		Hydraulic Oil Filter Transmission....	H-7102	Hydraulic Oil Filter.....	H-7914
Hydraulic Oil Filter.....	H-7914	B10L (BUSES) VOLVO THD102KB , 1992-UP		B58 (BUSES) VOLVO THD100D , 1979-1983	
B10M (BUSES) VOLVO THD102K , 1992		Hydraulic Oil Filter Transmission....	H-7102	Hydraulic Oil Filter.....	H-7914
Hydraulic Oil Filter.....	H-7914	B10L (BUSES) VOLVO THD102KD , 1992-UP		B59 (BUSES) VOLVO D50A , 1979-1983	
B10M (BUSES) VOLVO THD103 K , 1992		Hydraulic Oil Filter Transmission....	H-7102	Hydraulic Oil Filter.....	H-7914
Hydraulic Oil Filter.....	H-7914	B12 (BUSES) VOLVO THD100DB		B59 (BUSES) VOLVO HD100A , 1979-1983	
B10M (BUSES) VOLVO THD104 K , 1992		Hydraulic Oil Filter Transmission....	H-7102	Hydraulic Oil Filter.....	H-7914
Hydraulic Oil Filter.....	H-7914	B54 (BUSES) VOLVO D50A , 1979-1983		B59 (BUSES) VOLVO THD100A , 1979-1983	
B10M (BUSES) VOLVO THD100D/E , 1979-1985		Hydraulic Oil Filter.....	H-7914	Hydraulic Oil Filter.....	H-7914
Hydraulic Oil Filter.....	H-7914	B54 (BUSES) VOLVO HD100A , 1979-1983		B59 (BUSES) VOLVO THD100D , 1979-1983	
Hydraulic Oil Filter Transmission....	H-65030	Hydraulic Oil Filter.....	H-7914	Hydraulic Oil Filter.....	H-7914
Hydraulic Oil Filter Transmission....	H-7102	B54 (BUSES) VOLVO THD100A , 1979-1983		B59 (BUSES) VOLVO THD100D , 1979-1983	
B10R (BUSES) VOLVO THD100DB , 1978-1992		Hydraulic Oil Filter.....	H-7914	Hydraulic Oil Filter.....	H-7914
Hydraulic Oil Filter Transmission....	H-7102	B54 (BUSES) VOLVO THD100D , 1979-1983		B6 (BUSES) VOLVO TD63ES (S/N: T0-5000)	
Hydraulic Oil Filter.....	H-7914	Hydraulic Oil Filter.....	H-7914	Hydraulic Oil Filter Transmission....	H-7102
Hydraulic Oil Filter Transmission....	H-65030	B57 (BUSES) VOLVO TD70E , 1975-1981		B9M (BUSES) VOLVO THD101G , 1992-UP	
B10R (BUSES) VOLVO THD100D/E , 1978-1992		Hydraulic Oil Filter.....	H-7914	Hydraulic Oil Filter Transmission....	H-7102
Hydraulic Oil Filter Transmission....	H-7102	B57 (BUSES) VOLVO TD70H , 1975-1981		Hydraulic Oil Filter Transmission....	H-65030
Hydraulic Oil Filter Transmission....	H-65030	Hydraulic Oil Filter.....	H-7914	Hydraulic Oil Filter.....	H-7914



ENGINE APPLICATION

MODEL/APPLICATION	SAKURA NO	MODEL/APPLICATION	SAKURA NO	MODEL/APPLICATION	SAKURA NO
VOLVO		VOLVO		VOLVO	
B9M (BUSES) VOLVO THD102K , 1992-UP		BL61 PLUS (LOADERS) VOLVO D4D CBE1 , 2002		Hydraulic Oil Filter.....	H-2719
Hydraulic Oil Filter.....	H-7914	Hydraulic Oil Filter.....	HC-7001	Hydraulic Oil Filter.....	H-7101
Hydraulic Oil Filter Transmission....	H-7102	BL60 (LOADERS)		Hydraulic Oil Filter.....	HC-8805
Hydraulic Oil Filter Transmission...	H-65030	Hydraulic Oil Filter.....	HC-45050	EC240 (EXCAVATORS) 1996-UP	
B9M (BUSES) VOLVO THD103 K , 1992-UP		Hydraulic Oil Filter.....	HC-5506	Hydraulic Oil Filter.....	HC-8805
Hydraulic Oil Filter Transmission....	H-7102	BL70 (LOADERS) VOLVO D4D 10001 - 11488		Hydraulic Oil Filter.....	H-2719
Hydraulic Oil Filter Transmission...	H-65030	Hydraulic Oil Filter.....	HC-7001	EC25 (EXCAVATORS) MITSUBISHI S3L2 (S/N: 10151-99999) , 2005-UP	
Hydraulic Oil Filter.....	H-7914	Hydraulic Oil Filter.....	HC-7001	Hydraulic Oil Filter.....	HC-55190
B9M (BUSES) VOLVO THD104 K , 1992-UP		BL70 (LOADERS) VOLVO D5D 11489 - UP		EC290 (EXCAVATORS) 1996-UP	
Hydraulic Oil Filter Transmission...	H-65030	Hydraulic Oil Filter.....	HC-7001	Hydraulic Oil Filter.....	H-2719
Hydraulic Oil Filter.....	H-7914	BL71 (LOADERS) VOLVO D4D CBE1 , 2002-UP		Hydraulic Oil Filter.....	HC-8805
Hydraulic Oil Filter Transmission....	H-7102	Hydraulic Oil Filter.....	HC-5506	EC330B (EXCAVATORS)	
B9M (BUSES) VOLVO THD101G , 1992		Hydraulic Oil Filter.....	HC-45050	Hydraulic Oil Filter.....	H-2719
Hydraulic Oil Filter.....	H-7914	BL71 (LOADERS) VOLVO D4D CBE1 , 2002		Hydraulic Oil Filter.....	HC-5602
B9M (BUSES) VOLVO THD102K , 1992		Hydraulic Oil Filter.....	HC-7001	Hydraulic Oil Filter.....	H-2709
Hydraulic Oil Filter.....	H-7914	BL71 PLUS (LOADERS) VOLVO , 2007		EC360 (EXCAVATORS) 1996-UP	
B9M (BUSES) VOLVO THD103 K , 1992		Hydraulic Oil Filter.....	HC-7001	Hydraulic Oil Filter.....	H-2709
Hydraulic Oil Filter.....	H-7914	EC140B (EXCAVATORS)		Hydraulic Oil Filter.....	H-2719
B9M (BUSES) VOLVO THD104 K , 1992		Hydraulic Oil Filter.....	HC-8805	Hydraulic Oil Filter.....	HC-5602
Hydraulic Oil Filter.....	H-7914	Hydraulic Oil Filter.....	H-7101	EC390 (EXCAVATORS)	
BB57 (BUSES) VOLVO TD70E , 1975-1981		Hydraulic Oil Filter.....	H-2719	Hydraulic Oil Filter.....	HC-5508
Hydraulic Oil Filter.....	H-7914	EC160B (EXCAVATORS)		EC460C (EXCAVATORS) VOLVO D12D , 2008-UP	
BB57 (BUSES) VOLVO TD70H , 1975-1981		Hydraulic Oil Filter.....	HC-8805	Hydraulic Oil Filter additional part..	H-7105
Hydraulic Oil Filter.....	H-7914	Hydraulic Oil Filter.....	H-2719	EC460 (EXCAVATORS) 1996-UP	
BB57 (BUSES) VOLVO D70A , 1975-1981		Hydraulic Oil Filter.....	H-7101	Hydraulic Oil Filter.....	HC-5602
Hydraulic Oil Filter.....	H-7914	EC140 (EXCAVATORS) CUMMINS , 1996-UP		Hydraulic Oil Filter.....	H-2709
BB57 (BUSES) VOLVO TD70A , 1975-1981		Hydraulic Oil Filter.....	H-2719	Hydraulic Oil Filter.....	H-2719
Hydraulic Oil Filter.....	H-7914	Hydraulic Oil Filter.....	HC-8805	EC460B (EXCAVATORS)	
BB57 (BUSES) VOLVO D70B , 1975-1981		EC240B (EXCAVATORS) VOLVO D7DEBE2		Hydraulic Oil Filter.....	H-2719
Hydraulic Oil Filter.....	H-7914	Hydraulic Oil Filter.....	H-7101	Hydraulic Oil Filter.....	HC-5602
BB57 (BUSES) VOLVO TD70B , 1975-1981		Hydraulic Oil Filter.....	H-2719	Hydraulic Oil Filter.....	H-2709
Hydraulic Oil Filter.....	H-7914	Hydraulic Oil Filter Full Flow.....	HC-7901	Hydraulic Oil Filter.....	H-2719
BB57 (BUSES) VOLVO D70B , 1975-1981		Hydraulic Oil Filter.....	HC-8805	EC460B LC (EXCAVATORS)	
Hydraulic Oil Filter.....	H-7914	EC240BLC (EXCAVATORS)		Hydraulic Oil Filter.....	HC-5602
BL61 (LOADERS) VOLVO D4D CBE1 , 2002		Hydraulic Oil Filter.....	H-7101	ECR38 (EXCAVATORS) S/N: 60210151-60299999 , 2005-UP	
Hydraulic Oil Filter.....	HC-7001	EC210 (EXCAVATORS) 1996-UP		Hydraulic Oil Filter.....	HC-5506
BL61 PLUS (LOADERS) VOLVO , 2007		Hydraulic Oil Filter.....	HC-8805	EW170 (EXCAVATORS) 1996-UP	
Hydraulic Oil Filter.....	HC-7001	Hydraulic Oil Filter.....	H-2719	Hydraulic Oil Filter.....	HC-8805
BL61 PLUS (LOADERS) VOLVO , 2007		EC210B (EXCAVATORS) VOLVO D6D EFE2		Hydraulic Oil Filter.....	H-2719
Hydraulic Oil Filter.....	HC-7001	Hydraulic Oil Filter.....	HC-8805	FM300 (TRUCKS) VOLVO D11B (S/N: 6 CYL-UP) , 2008-UP	
			H-2719	Hydraulic Oil Filter.....	HC-5504



ENGINE APPLICATION

MODEL/APPLICATION	SAKURA NO	MODEL/APPLICATION	SAKURA NO	MODEL/APPLICATION	SAKURA NO
VOLVO		VOLVO		VOLVO	
FM300 (TRUCKS) VOLVO D13A (S/N: 6 CYL-UP) , 2008-UP Hydraulic Oil Filter.....	HC-5504	G940 (GRADERS) VOLVO D7E , 2006 Hydraulic Oil Filter.....	HC-7001	Hydraulic Oil Filter.....	H-71130
FM300 (TRUCKS) VOLVO D13B (S/N: 6 CYL-UP) , 2008-UP Hydraulic Oil Filter.....	HC-5504	G940B (GRADERS) VOLVO D8H , 2011 Hydraulic Oil Filter.....	HC-7001	L150E (LOADERS) VOLVO D12D , 2002-2007 Hydraulic Oil Filter.....	HC-7001
FM300 (TRUCKS) VOLVO D9B (S/N: 6 CYL-UP) , 2008-UP Hydraulic Oil Filter.....	HC-5504	G946 (GRADERS) VOLVO D7E , 2006 Hydraulic Oil Filter.....	HC-7001	L150E (LOADERS) VOLVO D10B Hydraulic Oil Filter.....	HC-7001
FM300 (TRUCKS) VOLVO D9B (S/N: 6 CYL-UP) , 2005-2008 Hydraulic Oil Filter.....	HC-5504	G946B (GRADERS) VOLVO D8H , 2011 Hydraulic Oil Filter.....	HC-7001	L150F (LOADERS) VOLVO D12D , 2007 Hydraulic Oil Filter.....	HC-7001
FM370 (TRUCKS) VOLVO D13C (S/N: E5/EEV-UP) , 2009-UP Hydraulic Oil Filter.....	HC-5504	G960 (GRADERS) VOLVO D7E , 2006 Hydraulic Oil Filter.....	HC-7001	L150G (LOADERS) VOLVO D13H-E , 2011 Hydraulic Oil Filter.....	HC-7001
FM400 (TRUCKS) VOLVO D13A , 2005-2008 Hydraulic Oil Filter.....	HC-5504	G960B (GRADERS) VOLVO D8H , 2011 Hydraulic Oil Filter.....	HC-7001	L150G (LOADERS) VOLVO D13H-F , 2011 Hydraulic Oil Filter.....	HC-7001
FM400 (TRUCKS) VOLVO D11B , 2005-2008 Hydraulic Oil Filter.....	HC-5504	L110E (LOADERS) VOLVO D7D LABE2 , 2002-UP Hydraulic Oil Filter.....	HC-5506	L150D (LOADERS) 2000-2002 Hydraulic Oil Filter.....	H-71130
FM400 (TRUCKS) VOLVO D13B , 2005-2008 Hydraulic Oil Filter.....	HC-5504	L110E (LOADERS) VOLVO D7D Hydraulic Oil Filter.....	HC-7001	Hydraulic Oil Filter.....	HC-5508
FM500 (TRUCKS) VOLVO D13B , 2007-2008 Hydraulic Oil Filter.....	HC-5504	L110F (LOADERS) VOLVO D7E , 2007 Hydraulic Oil Filter.....	HC-7001	L180C (LOADERS) VOLVO TD122KHE , 1997-2002 Hydraulic Oil Filter.....	HC-7001
G60 (GRADERS) Hydraulic Oil Filter Full Flow.....	HC-79331	L110F (LOADERS) VOLVO D7E , 2007 Hydraulic Oil Filter.....	HC-7001	L180C (LOADERS) VOLVO TD122KLE , 1997-2002 Hydraulic Oil Filter.....	HC-7001
G710 (GRADERS) Hydraulic Oil Filter.....	HC-5503	L120E (LOADERS) VOLVO D7DLAE2 , 2002-UP Hydraulic Oil Filter.....	HC-5506	L180E (LOADERS) VOLVO D12C , 2002-UP Hydraulic Oil Filter.....	HC-5506
Hydraulic Oil Filter.....	HC-5508	L120E (LOADERS) VOLVO D7DLAE2 Hydraulic Oil Filter.....	HC-7001	Hydraulic Oil Filter.....	H-71130
G720 (GRADERS) Hydraulic Oil Filter.....	HC-5503	L120F (LOADERS) VOLVO D7E , 2007 Hydraulic Oil Filter.....	HC-7001	L180E HL (LOADERS) VOLVO D12C , 2002-UP Hydraulic Oil Filter.....	H-71130
Hydraulic Oil Filter.....	HC-5508	L120G (LOADERS) VOLVO D8H , 2012 Hydraulic Oil Filter.....	HC-7001	Hydraulic Oil Filter.....	HC-5506
G740 (GRADERS) Hydraulic Oil Filter.....	HC-5503	L120B (LOADERS) 1991-1995 Hydraulic Oil Filter.....	HC-5508	L180E HL (LOADERS) VOLVO D12C , 2002 Hydraulic Oil Filter.....	HC-7001
G740B (GRADERS) VOLVO D10BGAE2 Hydraulic Oil Filter.....	HC-5503	L120C (LOADERS) 1986-1991 Hydraulic Oil Filter.....	HC-5508	L180F (LOADERS) VOLVO D12D , 2007 Hydraulic Oil Filter.....	HC-7001
Hydraulic Oil Filter.....	HC-5508	L120D (LOADERS) Hydraulic Oil Filter.....	HC-5508	L180G (LOADERS) VOLVO D13H-E , 2011 Hydraulic Oil Filter.....	HC-7001
G930 (GRADERS) VOLVO D7E , 2006 Hydraulic Oil Filter.....	HC-7001	L150E (LOADERS) VOLVO D10B , 2002-UP Hydraulic Oil Filter.....	HC-5506	L180G (LOADERS) VOLVO D13H-F , 2011 Hydraulic Oil Filter.....	HC-7001
G930B (GRADERS) VOLVO D8H , 2011 Hydraulic Oil Filter.....	HC-7001			L180D (LOADERS) Hydraulic Oil Filter.....	H-71130



ENGINE APPLICATION

MODEL/APPLICATION	SAKURA NO	MODEL/APPLICATION	SAKURA NO	MODEL/APPLICATION	SAKURA NO
VOLVO		VOLVO		VOLVO BM	
L180D (LOADERS)		L60E (LOADERS) VOLVO D6D LBE2 , 2002-UP		3500 (SCRAPERS) VOLVO	
Hydraulic Oil Filter.....	HC-5508	Hydraulic Oil Filter.....	HC-6802	Hydraulic Oil Filter.....	H-79411
L220D (LOADERS) VOLVO TD122KHE , 1997-2002		L90E (LOADERS) VOLVO D6D LBE2 , 2002-UP		412 (DUMP TRUCKS) SCANIA D8	
Hydraulic Oil Filter.....	HC-7001	Hydraulic Oil Filter.....	HC-5506	Hydraulic Oil Filter.....	H-71140
L220D (LOADERS) VOLVO TD122KLE , 1997-2002		L90E (LOADERS) VOLVO D6D LBE2 , 2002		412 (DUMP TRUCKS) VOLVO BM DS8	
Hydraulic Oil Filter.....	HC-7001	Hydraulic Oil Filter.....	HC-7001	Hydraulic Oil Filter.....	H-71140
L220D (LOADERS)		L90E (LOADERS) VOLVO D6D		414 (DUMP TRUCKS) SCANIA	
Hydraulic Oil Filter.....	H-71130	Hydraulic Oil Filter.....	HC-7001	Hydraulic Oil Filter.....	H-71140
Hydraulic Oil Filter.....	HC-5506	L90B (LOADERS) VOLVO TD61 , 1992-1995		420 (DUMP TRUCKS) SCANIA	
L220E (LOADERS) VOLVO D12C , 2002-UP		Hydraulic Oil Filter.....	HC-5508	Hydraulic Oil Filter.....	H-71140
Hydraulic Oil Filter.....	H-71130	L90D (LOADERS) 2000-2002		Hydraulic Oil Filter Transmission...	H-65030
Hydraulic Oil Filter.....	HC-5506	Hydraulic Oil Filter.....	HC-5508	4200 (SCRAPERS) PERKINS 4.236 , 1978-1983	
Hydraulic Oil Filter.....	HC-5508	MC90 (LOADERS) PERKINS 1004-42		Hydraulic Oil Filter.....	HC-7913
L220E (LOADERS) VOLVO D12C , 2002		Hydraulic Oil Filter.....	HC-5508	Hydraulic Oil Filter.....	HC-6802
Hydraulic Oil Filter.....	HC-7001	(DUMP TRUCKS) VOLVO TD121G		Hydraulic Oil Filter.....	H-85110
L220E (LOADERS) VOLVO D12D , 2002		Hydraulic Oil Filter.....	HC-5508	Hydraulic Oil Filter Transmission...	H-65030
Hydraulic Oil Filter.....	HC-7001	Hydraulic Oil Filter.....	H-85110	4300 (SCRAPERS) VOLVO BM TD45 , 1977-1982	
L220F (LOADERS) VOLVO D12D , 2007		OLYMPIAN MK II (BUSES) VOLVO THD100EA		Hydraulic Oil Filter.....	HC-6802
Hydraulic Oil Filter.....	HC-7001	Hydraulic Oil Filter Transmission....	H-7102	Hydraulic Oil Filter.....	H-85110
L220F (LOADERS) VOLVO D12D		SOME MODELS (TRUCKS) VOLVO TD100A		435 (DUMP TRUCKS) CUMMINS KT-1150	
Hydraulic Oil Filter.....	HC-5506	Hydraulic Oil Filter Power steering..	H-71160	Hydraulic Oil Filter.....	H-71140
L220G (LOADERS) VOLVO D13H-E , 2011		SOME MODELS (TRUCKS) VOLVO D70A		Hydraulic Oil Filter Transmission...	H-65030
Hydraulic Oil Filter.....	HC-7001	Hydraulic Oil Filter Power steering..	H-71160	Hydraulic Oil Filter.....	H-71140
L220G (LOADERS) VOLVO D13H-F , 2011		SOME MODELS (TRUCKS) VOLVO D100A		440 (DUMP TRUCKS) CUMMINS NT-855	
Hydraulic Oil Filter.....	HC-7001	Hydraulic Oil Filter Power steering..	H-71160	Hydraulic Oil Filter Transmission...	H-65030
L230 (TRUCKS) VOLVO A6		SOME MODELS (TRUCKS) VOLVO D100B		Hydraulic Oil Filter.....	H-71140
Hydraulic Oil Filter.....	H-85110	Hydraulic Oil Filter Power steering..	H-71160	Hydraulic Oil Filter.....	HC-6802
L330D (LOADERS) 2000-2002		VOLVO BM		4400 (SCRAPERS) VOLVO TD42 , 1978-1987	
Hydraulic Oil Filter.....	HC-5503	2005 (TRACTORS)		Hydraulic Oil Filter.....	H-85110
Hydraulic Oil Filter.....	H-71130	Hydraulic Oil Filter.....	HC-6802	Hydraulic Oil Filter.....	HC-6802
L330E (LOADERS) VOLVO D16B , 2002-UP		2650 (TRACTORS)		441 (DUMP TRUCKS) SCANIA DS14A	
Hydraulic Oil Filter.....	HC-5503	Hydraulic Oil Filter.....	HC-6802	Hydraulic Oil Filter.....	H-71140
Hydraulic Oil Filter.....	H-71130	30A (DUMP TRUCKS)		Hydraulic Oil Filter Transmission...	H-65030
L50D (LOADERS) 2000-UP		Hydraulic Oil Filter.....	HC-6802	445 (DUMP TRUCKS) GMC 12V-71T	
Hydraulic Oil Filter.....	H-85560	30A (DUMP TRUCKS)		Hydraulic Oil Filter.....	H-71140
Hydraulic Oil Filter.....	HC-5508	Hydraulic Oil Filter.....	H-85110	Hydraulic Oil Filter Transmission...	H-65030
Hydraulic Oil Filter.....	HC-6802	Hydraulic Oil Filter.....	HC-5504	4500 (SCRAPERS) VOLVO TD70H , 1979-1986	
				Hydraulic Oil Filter.....	HC-6802



ENGINE APPLICATION

MODEL/APPLICATION	SAKURA NO	MODEL/APPLICATION	SAKURA NO	MODEL/APPLICATION	SAKURA NO
VOLVO BM		VOLVO BM		VOLVO BM	
4500 (SCRAPERS) VOLVO TD70H , 1979-1986		DR860S (DUMP TRUCKS)		L160 (LOADERS) VOLVO TD101G , 1986-1992	
Hydraulic Oil Filter.....	H-85110	Hydraulic Oil Filter.....	H-85110	Hydraulic Oil Filter.....	H-85110
4600 (SCRAPERS) VOLVOBM TD100A , 1980-1983		DR860T (DUMP TRUCKS) VOLVOBM TD50B		Hydraulic Oil Filter.....	HC-6802
Hydraulic Oil Filter.....	H-85110	Hydraulic Oil Filter.....	H-5405	L17 (LOADERS) VOLVO	
Hydraulic Oil Filter.....	HC-6802	Hydraulic Oil Filter.....	H-85110	Hydraulic Oil Filter.....	HC-6802
4600 (LOADERS) VOLVO TD100G		EL70 (LOADERS)		L180 (LOADERS)	
Hydraulic Oil Filter.....	HC-6802	Hydraulic Oil Filter.....	HC-6802	Hydraulic Oil Filter.....	H-71130
4600B (SCRAPERS)		EL70C (LOADERS)		Hydraulic Oil Filter.....	HC-5508
Hydraulic Oil Filter.....	H-85110	Hydraulic Oil Filter.....	HC-6802	L50 (LOADERS) VOLVOBM D45B , 1999-UP	
Hydraulic Oil Filter.....	HC-6802	GM616 (EXCAVATORS) VOLVO D42		Hydraulic Oil Filter.....	HC-6802
5350 (DUMP TRUCKS) VOLVO TD70G		Hydraulic Oil Filter.....	H-85110	Hydraulic Oil Filter.....	H-85110
Hydraulic Oil Filter Transmission...	H-65030	GM616B (EXCAVATORS) VOLVOBM D45		L70 (LOADERS) VOLVOBM TD45D , 1986-1993	
Hydraulic Oil Filter.....	H-85110	Hydraulic Oil Filter.....	H-85110	Hydraulic Oil Filter.....	H-85110
Hydraulic Oil Filter Transmission....	H-7102	Hydraulic Oil Filter.....	HC-6802	Hydraulic Oil Filter.....	HC-6802
5350 (DUMP TRUCKS) VOLVOBM TD71G		GM616B (EXCAVATORS) VOLVOBM D45B		L90 (LOADERS) VOLVO BM TD61G , 1986-1991	
Hydraulic Oil Filter Transmission...	H-65030	Hydraulic Oil Filter.....	H-85110	Hydraulic Oil Filter.....	H-85110
Hydraulic Oil Filter Transmission....	H-7102	Hydraulic Oil Filter.....	HC-6802	LF70B (LOADERS)	
Hydraulic Oil Filter.....	H-85110	GM616B (EXCAVATORS) VOLVOBM TD45		Hydraulic Oil Filter.....	HC-6802
540 (DUMP TRUCKS) CUMMINS KT-1150		Hydraulic Oil Filter.....	H-85110	LM1254 (LOADERS)	
Hydraulic Oil Filter.....	H-71140	Hydraulic Oil Filter.....	HC-6802	Hydraulic Oil Filter Transmission...	H-65030
Hydraulic Oil Filter Transmission...	H-65030	GM616B (EXCAVATORS) VOLVOBM TD45B		LM1240 (LOADERS) 1972-1979	
550 (DUMP TRUCKS) DETROITD 16V-71N		Hydraulic Oil Filter.....	H-85110	Hydraulic Oil Filter.....	H-85110
Hydraulic Oil Filter.....	H-71140	Hydraulic Oil Filter.....	HC-6802	Hydraulic Oil Filter.....	HC-6802
Hydraulic Oil Filter Transmission...	H-65030	GM616B (EXCAVATORS) VOLVO D42		LM1241 (LOADERS)	
6300 (BACKHOE LOADERS) VOLVO BM TD4JB		Hydraulic Oil Filter.....	H-85110	Hydraulic Oil Filter.....	H-85110
Hydraulic Oil Filter.....	H-85110	Hydraulic Oil Filter.....	HC-6802	LM1640 STD (LOADERS) 1972-1980	
A20 (DUMP TRUCKS) VOLVO TD71G , 1986-1991		GM616B (EXCAVATORS) VOLVO TD42		Hydraulic Oil Filter Transmission...	H-65030
Hydraulic Oil Filter Transmission....	H-7102	Hydraulic Oil Filter.....	HC-6802	LM1640 TO SERIES 1441 (LOADERS) VOLVOBM D100	
Hydraulic Oil Filter.....	HC-5508	Hydraulic Oil Filter.....	H-85110	Hydraulic Oil Filter Transmission...	H-65030
Hydraulic Oil Filter.....	H-85110	GM646 (EXCAVATORS) VOLVO TD42		LM1640 TO SERIES 1441 (LOADERS) VOLVOBM TD100	
A25 (DUMP TRUCKS) VOLVO TD71K		Hydraulic Oil Filter.....	HC-6802	Hydraulic Oil Filter Transmission...	H-65030
Hydraulic Oil Filter Transmission....	H-7102	Hydraulic Oil Filter.....	H-85110	LM1641 (LOADERS) VOLVOBM D100 , 1972-1980	
Hydraulic Oil Filter.....	H-85110	L120B (LOADERS)		Hydraulic Oil Filter Transmission...	H-65030
DR860 (DUMP TRUCKS) VOLVOBM TD50A		Hydraulic Oil Filter.....	HC-5508	LM1641 (LOADERS) VOLVOBM TD100 , 1972-1980	
Hydraulic Oil Filter.....	H-5405	L150C (LOADERS)		Hydraulic Oil Filter Transmission...	H-65030
DR861 (DUMP TRUCKS) VOLVO		Hydraulic Oil Filter.....	H-71130	LM1641 (LOADERS) VOLVOBM TD100 , 1972-1980	
Hydraulic Oil Filter.....	H-85110	Hydraulic Oil Filter.....	HC-5508	Hydraulic Oil Filter Transmission...	H-65030
Hydraulic Oil Filter.....	HC-6802				



ENGINE APPLICATION

MODEL/APPLICATION	SAKURA NO	MODEL/APPLICATION	SAKURA NO	MODEL/APPLICATION	SAKURA NO
VOLVO BM		VOLVO BM		VOLVO CONSTRUCTION EQUIPMENT	
LM621 (LOADERS) VOLVOBM D42		VHK312 (GRADERS) VOLVO		Hydraulic Oil Filter.....	HC-5504
Hydraulic Oil Filter.....	H-85110	Hydraulic Oil Filter Transmission...	H-65030	LC120 (LOADERS)	
LM621HD (LOADERS) VOLVO D42		VHK3500 (GRADERS) VOLVO TD70E		Hydraulic Oil Filter.....	HC-5508
Hydraulic Oil Filter.....	H-85110	Hydraulic Oil Filter.....	H-51170	WAGNER	
Hydraulic Oil Filter.....	HC-6802	VOLVO CONSTRUCTION EQUIPMENT		FT4 (TRACTORS) DEUTZ	
LM621HD (LOADERS) VOLVOBM SERIES 8867		A25E (DUMP TRUCKS) 2007-UP		Hydraulic Oil Filter Transmission...	H-65030
Hydraulic Oil Filter.....	H-85110	Hydraulic Oil Filter.....	HC-5504	MT413 (DUMPERS) 2008-UP	
Hydraulic Oil Filter.....	HC-6802	A35D (DUMP TRUCKS) VOLVO D12C ADE2 , 2000-UP		Hydraulic Oil Filter Transmission...	H-65030
LM622 (LOADERS) VOLVO D45		Hydraulic Oil Filter.....	HC-5508	MT444 (TRUCKS) DETROIT DIESEL	
Hydraulic Oil Filter.....	HC-6802	Hydraulic Oil Filter.....	H-85560	Hydraulic Oil Filter.....	HC-5503
Hydraulic Oil Filter.....	H-85110	A35E (DUMP TRUCKS) 2007-UP		WHITE	
MK691 (CRANES) VOLVO		Hydraulic Oil Filter.....	HC-5504	1750 (TRACTORS) WHITE GASOLINE	
Hydraulic Oil Filter.....	H-71140	EC210BLC (EXCAVATORS) VOLVO D6D EAE2 , 1996-UP		Hydraulic Oil Filter.....	H-51170
MK693 (CRANES) VOLVO		Hydraulic Oil Filter.....	HC-8805	1755 (TRACTORS) WHITE DIESEL	
Hydraulic Oil Filter.....	H-71140	Hydraulic Oil Filter.....	H-2719	Hydraulic Oil Filter.....	H-51170
MK693 (CRANES) VOLVO TURBO		Hydraulic Oil Filter.....	H-7101	1755 (TRACTORS) WHITE GASOLINE	
Hydraulic Oil Filter.....	H-71140	EC240B NLC (EXCAVATORS)		Hydraulic Oil Filter.....	H-51170
P654 (LOADERS) VOLVOBM D47B		Hydraulic Oil Filter.....	H-7101	1800B (TRACTORS)	
Hydraulic Oil Filter Transmission...	H-65030	HTE1160 (AIR COMPRESSORS) 2007-UP		Hydraulic Oil Filter.....	H-51170
P654 (LOADERS) VOLVOBM D50A		Hydraulic Oil Filter.....	HC-5506	1870 (TRACTORS) WHITE DIESEL	
Hydraulic Oil Filter Transmission...	H-65030	L150F (LOADERS) VOLVO D12D , 2007-UP		Hydraulic Oil Filter.....	H-51170
P854 (LOADERS) VOLVOBM D70A		Hydraulic Oil Filter.....	HC-5506	1870 (TRACTORS) WHITE LP GAS	
Hydraulic Oil Filter Transmission...	H-65030	L180F (LOADERS) VOLVO , 2007-UP		Hydraulic Oil Filter.....	H-51170
T-500 (TRACTORS)		Hydraulic Oil Filter.....	HC-5506	2-105 (TRACTORS) WHITE 354 TURBO	
Hydraulic Oil Filter.....	H-5410	L330C (LOADERS) VOLVO TD161		Hydraulic Oil Filter.....	H-51170
T800 (TRACTORS) VOLVOBM D50		Hydraulic Oil Filter.....	HC-5503	2-110 (TRACTORS) WHITE 354 CID	
Hydraulic Oil Filter.....	HC-6802	Hydraulic Oil Filter.....	H-71130	Hydraulic Oil Filter.....	H-51170
T800 (TRACTORS) VOLVOBM D60		L50C (LOADERS)		2-150 (TRACTORS)	
Hydraulic Oil Filter.....	HC-6802	Hydraulic Oil Filter.....	H-85560	Hydraulic Oil Filter.....	H-51170
T800 (TRACTORS) VOLVOBM TD50		Hydraulic Oil Filter.....	HC-5508	2255 (TRACTORS)	
Hydraulic Oil Filter.....	HC-6802	Hydraulic Oil Filter.....	HC-6802	Hydraulic Oil Filter.....	H-51170
T800 (TRACTORS) VOLVOBM TD60		L60F (LOADERS) VOLVO D6E LCE3 , 2007-UP		2655 (TRACTORS)	
Hydraulic Oil Filter.....	HC-6802	Hydraulic Oil Filter.....	HC-5504	Hydraulic Oil Filter.....	H-51170
VAK510 (GRADERS) VOLVO		L70F (LOADERS) VOLVO D6E , 2007-UP		Hydraulic Oil Filter.....	H-51170
Hydraulic Oil Filter.....	H-5406	Hydraulic Oil Filter.....	HC-5504	2-85 (TRACTORS) WHITE 354 DIESEL	
		L90F (LOADERS) VOLVO D6E , 2007-UP		Hydraulic Oil Filter.....	H-51170



ENGINE APPLICATION

MODEL/APPLICATION	SAKURA NO	MODEL/APPLICATION	SAKURA NO	MODEL/APPLICATION	SAKURA NO
WHITE		WHITE		WOODS & COPELAND	
4-150 (TRACTORS) CAT 3208 Hydraulic Oil Filter.....	H-51170	G-1050 (TRACTORS) WHITE 504-6 DIESEL Hydraulic Oil Filter.....	H-51170	320 (TRACTORS) CUMMINS Hydraulic Oil Filter Transmission...	H-65030
4-175 (TRACTORS) CAT 3208 Hydraulic Oil Filter.....	H-51170	G-1050 (TRACTORS) WHITE LP GAS Hydraulic Oil Filter.....	H-51170	WORTHINGTON	
6710 (TRACTORS) CUMMINS 5.9L Hydraulic Oil Filter.....	H-7916	G1350 (TRACTORS) WHITE 504-6 DIESEL Hydraulic Oil Filter.....	H-51170	ROLLAIR 6000 (AIR COMPRESSORS)	
6810 (TRACTORS) CUMMINS 5.9L Hydraulic Oil Filter.....	H-7916	G1350 (TRACTORS) WHITE LP GAS Hydraulic Oil Filter.....	H-51170	Hydraulic Oil Filter Transmission... HC-2701	
7300 (AGRICULTURE) WHITE GAS Hydraulic Oil Filter.....	HC-7932	G1355 (TRACTORS) WHITE DIESEL Hydraulic Oil Filter.....	H-51170	XCMG	
7600 (COMBINES) CHRYSLER V8 Hydraulic Oil Filter.....	H-51170	G1355 (TRACTORS) WHITE DIESEL Hydraulic Oil Filter.....	H-51170	XE210 (EXCAVATORS) BB-6BG1TRP-01 Hydraulic Oil Filter..... H-42190	
7800 (COMBINES) CHRYSLER V8 Hydraulic Oil Filter.....	H-51170	G1355 (TRACTORS) WHITE LP GAS Hydraulic Oil Filter.....	H-51170	XGMA	
8310 (TRACTORS) CUMMINS 6B5.9 Hydraulic Oil Filter.....	H-7916	G-900 (TRACTORS) WHITE 425 LP GAS Hydraulic Oil Filter.....	H-79411	XG815LC (EXCAVATORS) BB-4BG1TRP Hydraulic Oil Filter Return..... H-7981	
8510 (TRACTORS) CUMMINS 8.3L Hydraulic Oil Filter.....	H-7916	G-900 (TRACTORS) WHITE D-451-6 Hydraulic Oil Filter.....	H-79411	XG822LC (EXCAVATORS) BB-6BG1TRP-02 Hydraulic Oil Filter Return..... H-7981	
8600 (COMBINES) WHITE D-354 Hydraulic Oil Filter.....	H-51170	G-950 (TRACTORS) WHITE 451 DIESEL Hydraulic Oil Filter.....	H-51170	XG833 (EXCAVATORS) AA-6HK1XQP Hydraulic Oil Filter Return..... H-7981	
8710 (TRACTORS) CUMMINS 6CTA8.3 Hydraulic Oil Filter.....	H-7916	G-950 (TRACTORS) WHITE LP GAS Hydraulic Oil Filter.....	H-51170	XG932 (LOADERS) 6108G Hydraulic Oil Filter..... H-85710	
A4T-1600 (TRACTORS) WHITE DIESEL Hydraulic Oil Filter.....	H-51170	G-955 (TRACTORS) WHITE DIESEL Hydraulic Oil Filter.....	H-51170	XG932 (LOADERS) 6110 Hydraulic Oil Filter..... H-85710	
AFT-1400 (TRACTORS) WHITE 504 DIESEL Hydraulic Oil Filter.....	H-51170	G-955 (TRACTORS) WHITE LP GAS Hydraulic Oil Filter.....	H-51170	YALE & TOWNE	
G-1000 (TRACTORS) WHITE DIESEL Hydraulic Oil Filter.....	H-51170	MO-TRAC (POWER UNITS) WHITE 206M-4 Hydraulic Oil Filter Transmission...	H-65030	134A (FORKLIFTS) PERKINS 6.354 Hydraulic Oil Filter Transmission... H-65030	
G-1000 (TRACTORS) WHITE LP GAS Hydraulic Oil Filter.....	H-51170	MO-TRAC (POWER UNITS) WHITE D-206A-4 Hydraulic Oil Filter Transmission...	H-65030	204A (FORKLIFTS) LEYLAND UE400.680 Hydraulic Oil Filter Transmission... H-65030	
G-1000 VISTA (TRACTORS) WHITE 504-6 DIESEL Hydraulic Oil Filter.....	H-51170	WILLMAR		300 (FORKLIFTS) DETROITD 6V-53 Hydraulic Oil Filter Transmission... H-65030	
G-1000 VISTA (TRACTORS) WHITE 504-6 LP GAS Hydraulic Oil Filter.....	H-51170	Wrangler (LOADERS) FORD 172 G Hydraulic Oil Filter..... H-51170		304 (FORKLIFTS) DETROITD 8V-53 Hydraulic Oil Filter Transmission... H-65030	
		WIRTGEN		304 (FORKLIFTS) YALE TOWN 8V-71 Hydraulic Oil Filter Transmission... H-65030	
		SP-250 (FINISHERS) IVECO 8045 Hydraulic Oil Filter..... H-7974		8000 (FORKLIFTS) DETROITD 12V-71N Hydraulic Oil Filter Transmission... H-65030	
				YANMAR	
				B12 (CONSTRUCTION EQUIPMENTS) Hydraulic Oil Filter..... H-5625	



ENGINE APPLICATION

MODEL/APPLICATION	SAKURA NO	MODEL/APPLICATION	SAKURA NO
YANMAR		ZF	
B14 (CONSTRUCTION EQUIPMENTS)		Hydraulic Oil Filter.....	HC-76110
Hydraulic Oil Filter.....	H-5625	WG180 (TRANSMISSIONS)	
B17 (CONSTRUCTION EQUIPMENTS)		Hydraulic Oil Filter Transmission...	HC-2701
Hydraulic Oil Filter.....	H-5625		
B22 (CONSTRUCTION EQUIPMENTS) S/N: 0-900999			
Hydraulic Oil Filter.....	H-5625		
B22 (CONSTRUCTION EQUIPMENTS) S/N: 910000-UP			
Hydraulic Oil Filter.....	H-5625		
B22.1 (CONSTRUCTION EQUIPMENTS) S/N: 910000-910000			
Hydraulic Oil Filter.....	H-5625		
B22-2A (CONSTRUCTION EQUIPMENTS)			
Hydraulic Oil Filter.....	H-5625		
(ENGINES) YANMAR LA100A			
Hydraulic Oil Filter Transmission..	HC-52010		
YB101 (CONSTRUCTION EQUIPMENTS)			
Hydraulic Oil Filter Transmission..	HC-52010		
ZETOR			
12045 CRYSTAL (AGRICULTURE) 12045 CRYSTAL			
Hydraulic Oil Filter.....	HC-1822		
ZETTECMEYER			
801 (CONSTRUCTION EQUIPMENTS)			
Hydraulic Oil Filter.....	HC-62020		
ZL1700 (LOADERS) DEUTZ F6L912			
Hydraulic Oil Filter.....	H-71140		
ZL1700 (LOADERS) MERCEDES OM352A			
Hydraulic Oil Filter.....	H-71140		
ZL4001B (LOADERS) DEUTZ			
Hydraulic Oil Filter.....	HC-6802		
ZL4002 (LOADERS) CUMMINS LT10 , 1992			
Hydraulic Oil Filter Transmission...	HC-2701		
ZL5001F (LOADERS) DEUTZ , 1992			
Hydraulic Oil Filter.....	HC-6802		
ZF			
WG120 (TRANSMISSIONS)			